



ALL ABOUT NAZI  
ANTIGRAVITY DISC  
AEROSPACE WEAPONS

ROB ARNDT

# Disc Aircraft of The Third Reich

## Introduction

by **Rob Arndt**

Probably the most misunderstood and problematic of all terrestrial-based disc technology lies at the heart of the German disc programs that started with the birth of the NSDAP (Nazi Party) in 1920- a full 13 years before Adolf Hitler came to power as the leader of the Third Reich.

To fully comprehend the depth of these programs requires the knowledge that above all else the NSDAP was founded from the onset by the occult Thule (1917) and Vril (1919) Gesellschafts (Societies), and other occult groups like the DHvSS (Men of the Black Stone) that stretched back to the turn of the 20th century with the old German Order (a.k.a. Order of Teutons).

As such the very first disc project in Germany built in 1922 was not even an aircraft but an inter-dimensional flight machine in disc form- the [JFM](#) built by Thule-Vril.

When Adolf Hitler (a Thule member along with Goering, Himmler, and various other top Nazi officials) became chancellor in Germany in 1933 the 11 year occult metaphysical science of Thule-Vril became strengthened by official state backing for the continued disc development programs starting with an RFZ (RundFlugZeug), or "Round Aircraft" series of discs that utilized levitators developed by W.O. Schumann of the Technical University of Munich who worked on the JFM.

1934 saw the first [RFZ discs](#) built which led in five short years to two vast programs of highly advanced disc aircraft overseen by Himmler's SS- specifically, the SS technical branch Unit E-IV (Entwicklungsstelle 4) which was created to explore various alternative energies. This unit was tasked with developing both the [Haunebu](#) and [Vril disc](#) designs that utilized the world's first electro-magnetic-gravitic drive systems: the Vril and Thule Triebwerks. These drives relied on Hans Coler's free energy Konverter coupled to a Van De Graaf band generator and Marconi vortex dynamo (a huge spherical tank of mercury) to create powerful rotating electromagnetic fields that affected gravity.

Many have often inquired why then when war started in 1939 did Germany not use these advanced and unique machines in air combat? The simple truth lies in the fact that these machines, despite their superior overall performance to conventional piston-engined aircraft and early jets, could not be realistically adapted to any useful military role other than the most basic transport and recon work. The strong EM engines were difficult to control and could not hope to imitate the flight characteristics of high performance fighters like the Me BF 109 or Fw 190.

There was very little room for either offensive or defensive armament in these designs except for a few experimental light MG and MK cannons that proved impractical in flight and a rather large experimental Donar (Thunder) Kraftstrahlkanone (Strong Jet Cannon). These guns tended to destabilize the disc badly and were eventually removed. The disc bodies themselves were not capable of carrying any ordnance at all internally or externally (no bombs, unguided rockets, or missiles) and could only make turns of 22.5, 45, and 90 degrees.

Nevertheless, the SS pursued an aggressive policy of theft, forced cooperation, and strong internal development of these types of machines due to the increasing Allied bombing offensive that made conventional aircraft take-offs and landings highly dangerous. VTOL was seen as the logical solution to this problem. If the SS could develop a production machine that in the future could be armed (with cannon, missiles, or even an electrostatic weapon) then Germany might be able to turn the air war.

To shorten the time of finding VTOL solutions, the SS robbed both Germany's patent office and every patent office in occupied Europe. Those with aeronautical skill enough to contribute to the SS effort were either arrested or coerced into participating in the programs- among them Viktor Schauberger of Austria and Henri Coanda of Rumania. The SS also used its large slave labor force to assist in construction of large underground facilities for these discs and often for production of components to these machines.

Although the SS requested additional slave laborers from Armaments Minister Albert Speer, Speer himself was not told what war projects the laborers would be used for; indeed, Speer was deliberately kept out of the entire SS disc development programs for security reasons and the fact that the SS was a state-within-a-state with its own production

facilities, war material, scientists and technicians, slave workforce, and the knowledge of secret Third Reich military bases outside Germany where these discs were both tested and stored.

Among those held, Viktor Schauberger became the leader of most interest due to his highly unconventional use of liquid vortex technology which was perfected while he was in custody at Mauthausen. Originally designed for an odd bio-submarine, the strange Repulsin discoid motors were to be adapted to aircraft. Heinkel was the first to receive the results of these early discoid tests but refused to act on it.

A year after the Repulsin Model A motor was being studied one of Heinkel's own engineers named Rudolf Schriever proposed his own "Flugkreisel" (Flying Gyro) that utilized conventional jet engines instead of the Repulsin discoid motor. His design was taken from him and handed over to a team of scientists for further study and the construction of a large flying prototype. The team consisted of Dr. Richard Miethe, Klaus Habermohl, and an Italian- Dr. Guisepppe Belluzzo, who had come up with his own design for a jet powered round flying bomb- the Turboproietti.

Meanwhile, BMW started work on a design very similar to Schriever's Flugkreisel but utilizing the company's own BMW 003 jet engines. These machines, called 'Flugelrads" (Winged Wheels) were not really true disc aircraft but jet autogyros that used a standard BMW 003 with a Strahlrohr (Jet pipe) deflector to power a multi-blade disc rotor. These craft were built on a much smaller scale than Schriever's Flugkreisel so work proceeded from 1941-45 with construction of prototypes beginning in 1943. Instability, however, was never really solved in the earlier designs. One disc, however, a BMW Fluglerad II V-2 possibly achieved flight in April 1945.

Schriever's own disc began to take shape in 1943 as well and flew under jet power provided by three attached special kerosene-burning jet engines driving the disc rotor as well as two kerosene jets on the body for forward thrust and horizontal stability.

Flight characteristics were good but then the SS decided to abruptly drop Schriever's jet-fan design in favor of Miethe's version that eliminated the large disc rotor blades driven by jet engines for Schauberger's liquid vortex engine, but on a larger scale. With Schauberger released back to Austria in 1944 by the SS, the Miethe disc took to the air that same year over the Baltic.

At the same time a private venture with official backing from Air Ministry General Udet was taking shape in Leipzig. Arthur Sack who caught the attention of Udet way back in 1939 with his A.S.1 circular wing flying aero model was given permission and some funding to build a manned large-scale version of his model. Sack took up the challenge and built 4 more models of increasing size. When the A.S.5 demonstrated that the basic concept was sound construction began on the manned version in early 1944- the A.S.6. Within a month the strange largely wooden aircraft utilizing salvaged parts from a ME BF 108 was taxiing and making attempts to fly. But this project was doomed from the start with an underpowered engine and plagued by structural problems which meant the aircraft could hop- but never fly.

Due to round-the-clock bombing the SS was forced to try even more drastic measures, launching unmanned interceptor discs from the Schwarzwald. These discs were known as the "Feuerball" weapon, sometimes erroneously referred to as the mystery "V-7" weapon (of which there never was an official designation). The WNF Feuerball relied on a rocket motor for launch, a plume sensor for aerial detection, and an electrostatic field weapon invented at Messerschmitt's Oberammergau facility. Production of these craft was initially performed by WNF. Because the discs burned chemicals around its ring to create the electrostatic field necessary to disable Allied bomber engines and radar the object was soon nicknamed the "Foo Fighter" by the Allies who sighted this fiery halo weapon approaching them by day or night. FOO was a take on the French word Feu (Fire) and from the Smokey Stover comic of a bumbling fireman that actually started fires!

Naturally, WNF observed the burning effect too and soon nicknamed their weapon the WNF Feuerball (Fireball). The Feuerballs plagued the 415th NFS from November 1944 to April 1945. By that time production had been shifted to the Zeppelin Werk that nicknamed the larger improved weapon as "Kugelblitz" (Ball Lightning). The Allies seemed confused by these weapons which ranged in size from small to large and attacked in singles or multiples. The Germans further confused the Allies by launching "Seifenblasen" along with the Feuerballs.

Seifenblasen (Soap Bubbles) were large weather balloons trailing metal strips that confused Allied radar. Their large round shape reflecting in daylight gave them the appearance of a shining globe similar to the Feuerball. The Germans further complicated the identification of the "Foo Fighters" with a range of smaller purely spherical aerial probes that were used as psychological weapons. These "KugelWaffen" (Ball weapons) played aerial games with the Allied bomber gunners that would have in time distracted them from the real threat of larger approaching Kugelblitz discs.

But by the spring of 1945 the war was lost regardless and most of the remaining disc programs were halted. Henri Coanda had been arrested in Paris in 1940 and forced to work on a disc under SS supervision. His design for a

lenticular disc that benefited from his own "Coanda effect" was a masterpiece of jet disc design. But because it required 12 JUMO 004 jets to power the huge machine the project never got past the wind tunnel testing phase. Likewise, Andreas Epps independent Omega Diskus which utilized two Pabst ramjets and 8 Argus lift fans was also confined to 1/10th scale model testing.

Dr. Alexander Lippisch had also studied disc aerodynes back in 1941 but was too involved in the ME-163 Komet and DM-1 delta glider programs to produce anything more than brief design concepts based on the Gottingen K 1253 disc wing profile. The Horten brothers, experts with flying wings, also studied circular wing designs but did not actually work on any in Nazi Germany. They did so for the US Govt. postwar in late 1945-46 producing what is now believed to be the craft that crashed at Roswell in 1947- a spy craft parabolic lifting body carried by a large meteorological balloon.

In the face of imminent defeat BMW destroyed all their Flugelrads. Schriever's Flugkreisel was also destroyed. Miethe's disc may have been captured as Miethe went to Canada postwar to work on AVRO's designs.

Habermohl was captured by the Russians while Dr. Belluzzo returned to Italy. Schauburger's Repulsins were also captured by the Allies while most of the SS scientific branch records still intact were captured by the British who postwar attempted to create a working design through AVRO Canada with eventual US assistance.

One very little known Peenemunde disc project under Heinrich Fleissner was the last disc to take off from Berlin in late April 1945 on an official mission. But details of the "Dusenscheibe" (Devils Disc) remain clouded in mystery. Meanwhile, the Feuerball attacks that stopped in April 1945 in Germany resumed in August 1945 in Japan- an obvious technology transfer from Germany to Japan via U-Boat. The Japanese, however, lacked all the documentation for this weapon and only launched a few. It is said that the Japanese were frightened by this "demonic thing" and destroyed the remaining Feuerballs by dynamiting them in a pit. Photographic evidence also seems to identify "Kugelwaffen" sent to Japan as well as several are seen trailing Sally bombers, probably for flight testing.

But the Third Reich story ends as strangely as it had begun. What about the mysterious Thule-Vril discs which were actually built in small numbers? By 1945 there were quite a few Haunebu II and Vril 7 discs flying. Vril had even tested the Vril 8 Odin and possibly the even more streamlined Vril-9 Abjager. These craft were not destroyed but evacuated from March 1945 to an area safe from Allied bombing or capture.

In the year preceding the start of WW2 Germany sent an expedition to [Antarctica](#) to scout out a location for a military base there. The Germans found such a location in the former Queen Maud Land which Germany renamed [Neu Schwabenland](#). There, in secret during 1942-43, a base was built in the [Muhlig-Hoffman mountains](#). Base 211 (or Station 211). The base was supplied with slave laborers shipped by sea and U-boats to construct an elaborate cave complex deep within the mountains- an impregnable fortress. Hot internal springs were found there, iron ore deposits, vegetation and access was achieved primarily through an underwater trench that ran through the area.

During the war, especially the latter part, German U-boats made frequent trips to the South Atlantic, South America, and Antarctica. Germany also set up floating meteorological buoys in Antarctic waters and weather stations on islands located between Antarctica and the tip of South America. The SS RuSHA, (Rasse und SeidlungshauptAmt- Race and Settlement Bureau) began in 1942 to take women of Aryan decent (Volksdeutsch) from the Ukraine solely for the purpose of transporting them to Base 211.

Ten thousand women between the ages of 17-24, blonde and well proportioned, were recruited for the project along with 2,500 Waffen SS soldiers serving in Russia. The goal of this massive undertaking was to create a colony at Base 211 suitable for habitation and continued development of the Thule-Vril technology. It is believed that both the Thule and Vril Gesellschafts evacuated that technology to Base 211 at the close of the war under SS General Kammler, who was in charge of Germany's most secret weapons programs.

Two U-boats that surrendered after the war in Argentina are also believed to have carried cargo and high-ranking SS to Base 211. Both boats were empty upon surrender with the crews refusing to disclose their cargos and destinations.

It became apparent in 1946 that 54 U-boats and over 6,000 technicians and scientists were "missing" from Germany- especially from the SS Technical Branch. There were also 40, 000 slave laborers and between 142,000-250,000 German citizens unaccounted for. Despite simply writing these off as probable losses and deaths of the war, Washington suspected that a large number of these missing actually escaped to South America and Base 211 (if such a base existed). The US then went on a hunt using the "war criminal" propaganda to cover up the search for technology akin to a [South American version of "Operation Paperclip"](#).

The United States was so concerned about the secret base that in 1947 with the first Antarctic summer "[Operation Highjump](#)" was launched with a full military task force headed by [Admiral Byrd](#). The task forth was to head straight for

[Neu Schwabenland](#) and recon the area for a base. If one was found 4,700 armed troops would have been sent to capture it or destroy it. The task force performed the aerial recon, trailing magnetometers to detect any magnetic anomalies under the ice... but several of Byrd's planes were lost.

The aircraft had run into enemy opposition. "Operation Highjump" ended in failure as Byrd headed back after several weeks, far short of the 8 months that was intended. In his unofficial comments to the South American press Byrd stated that he was attacked by "enemy aircraft" that "could fly from pole to pole at incredible speed". Subsequently, the modern UFO phenomenon sprang up in 1947 and concentrated disc development programs were initiated in the '50s that have continued on to present-day "[black project](#)" aircraft operated by the CIA, NSA, and NRO.

So the story of the Third Reich disc programs does not end with the collapse of the Third Reich itself. It continues unresolved...

[http://www.bibliotecapleyades.net/ufo\\_aleman/esp\\_ufoaleman\\_1.htm#Introduction](http://www.bibliotecapleyades.net/ufo_aleman/esp_ufoaleman_1.htm#Introduction)

**JFM**  
**Jenseitsflugmaschine (Other World Flight Machine)**  
(1922-1924)

by Rob Arndt



**"Germany's first disc"**

In the summer of 1922 in a small barn outside of Munich the occult **Thule** and **Vril Gesellschafts** set about to create an **interdimensional flight machine** based upon channeled information received by their two mediums (**Maria Orsich** and **Sigrun**) from **Aldeberan** in the **Taurus Constellation**, 68 light years away.

**Maria**, the **Thule medium**, had been receiving information from what she believed was **Aryan aliens** living on **Aldeberan** since 1919 but could not translate their language and strange mental images.

**Sigrun**, the **Vril medium** was brought in to help translate these communications and images which was in the form of a strange circular flight machine with an even stranger cylindrical powerplant beyond all conventional science of the time.

**Thule** and **Vril** secretly called this craft the **Jenseitsflugmaschine**, or "**Other World Flight Machine**".

The **Gesellschafts** then used their members in the German business community to raise funds for the construction of this machine under the code letters **J-F-M**.

By 1922, parts for the machine began arriving independently from various industrial sources paid in full by the **Thule** and **Vril Gesellschafts**.

The machine itself was a disc craft with three inner disc plates inside and a cylindrical power unit running through the center of all three plates. The central disc plate measured 8 meters in diameter; above it in parallel was a disc plate of 6.5 meters diameter and below an equally parallel disc of 7 meters diameter. Through the center of all three disc plates

ran a 2.4 meter high cylindrical power unit that fit into a running 1.8 meter hole that culminated at the bottom of the disc body with a conical point to which was attached an enormous pendulum to stabilize the equipment once the unit was operating.

Once activated, the cylindrical power unit which consisted of an electric starter motor and high power generator started the upper and lower disc plates spinning in opposite directions to create a rotating electromagnetic field that was increasingly intensified. The intensity and frequency of the field oscillations increased in theory up to a point where an **interdimensional** oscillation occurred, opening a gateway or portal to another world. The **occultists** called this a "**white hole**" that theoretically would connect the **JFM** to **Aldeberan's** corresponding frequency oscillations and navigate the machine through to that world. The sole purpose of this machine was to reach **Aldeberan** and make contact directly with those that had supplied the information through channeling.

Two years of research was done with the **JFM** until 1924 when the machine was hurriedly dismantled and moved to Augsburg where it eventually was placed in storage at **Messerschmitt's** facility. With the end of the war, no trace was ever found of the **JFM**. Perhaps it was destroyed in an Allied bombing raid or simply taken apart by the Germans themselves out of fear. No one is certain.

But whether or not the **JFM** actually worked, one thing is certain: the **Thule** and **Vril Gesellschafts**, with the help of **W.O. Schumann** of the **Technical University of Munich**, developed some form of levitator unit from it that would be utilized in further German disc aircraft with the **RFZ (Rundflugzeug)** types starting in 1934 and ending with the fantastic **Vril** and **Haunebu** discs of 1939-1945.

[Return](#)

[http://www.bibliotecapleyades.net/ufo\\_aleman/esp\\_ufoaleman\\_7.htm](http://www.bibliotecapleyades.net/ufo_aleman/esp_ufoaleman_7.htm)

## Document's Photo Gallery

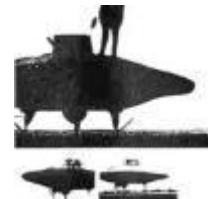
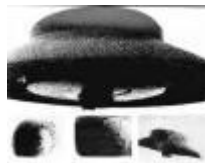



**Table 1: Air Base Temperature of the Structure**

Month	Temperature (°C)
January	12.4
February	13.2
March	14.1
April	15.0
May	16.0

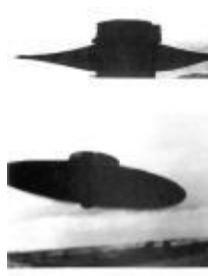
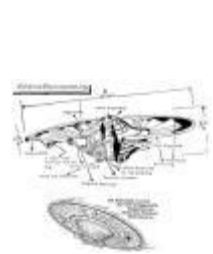

**FIG. 1. Air Base Temperature of the Structure**

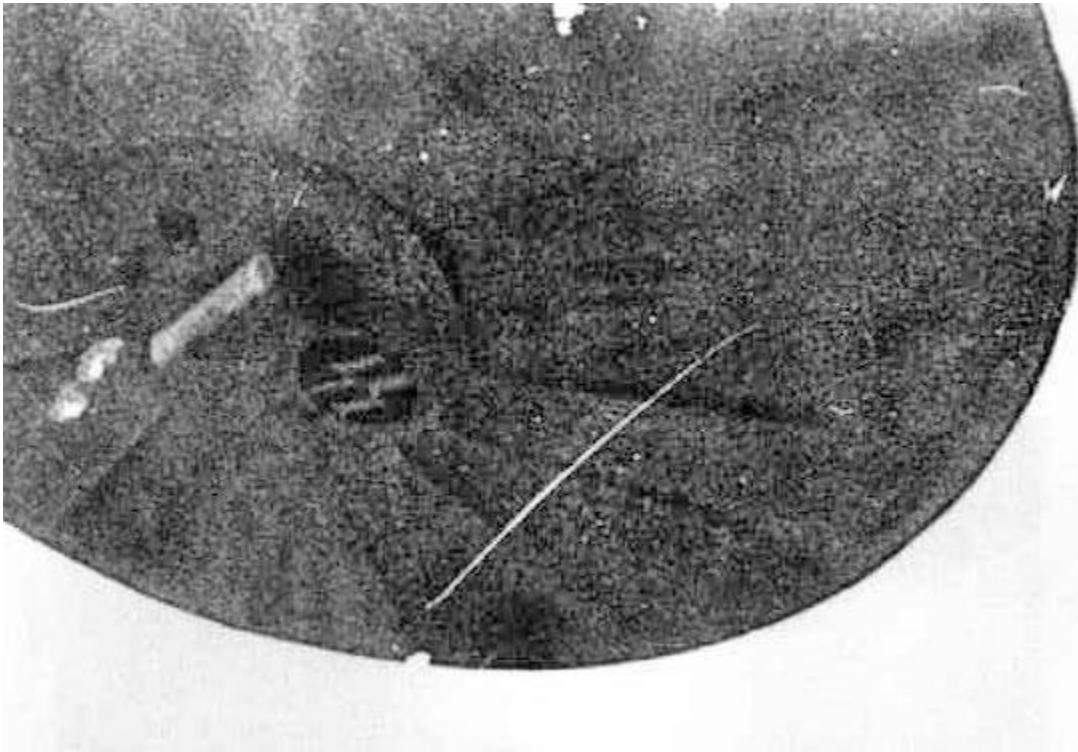

**Table 2: Air Base Temperature of the Structure**

Month	Temperature (°C)
January	12.4
February	13.2
March	14.1
April	15.0
May	16.0



Return



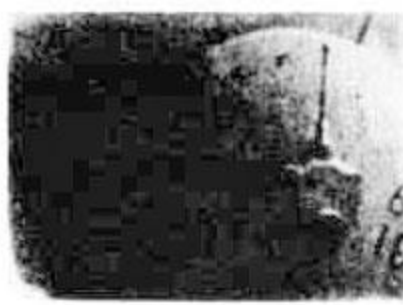
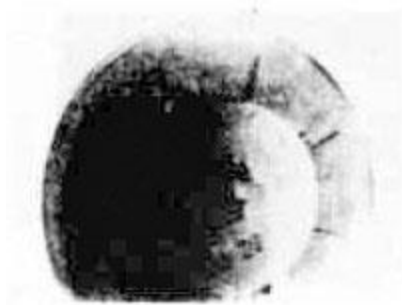
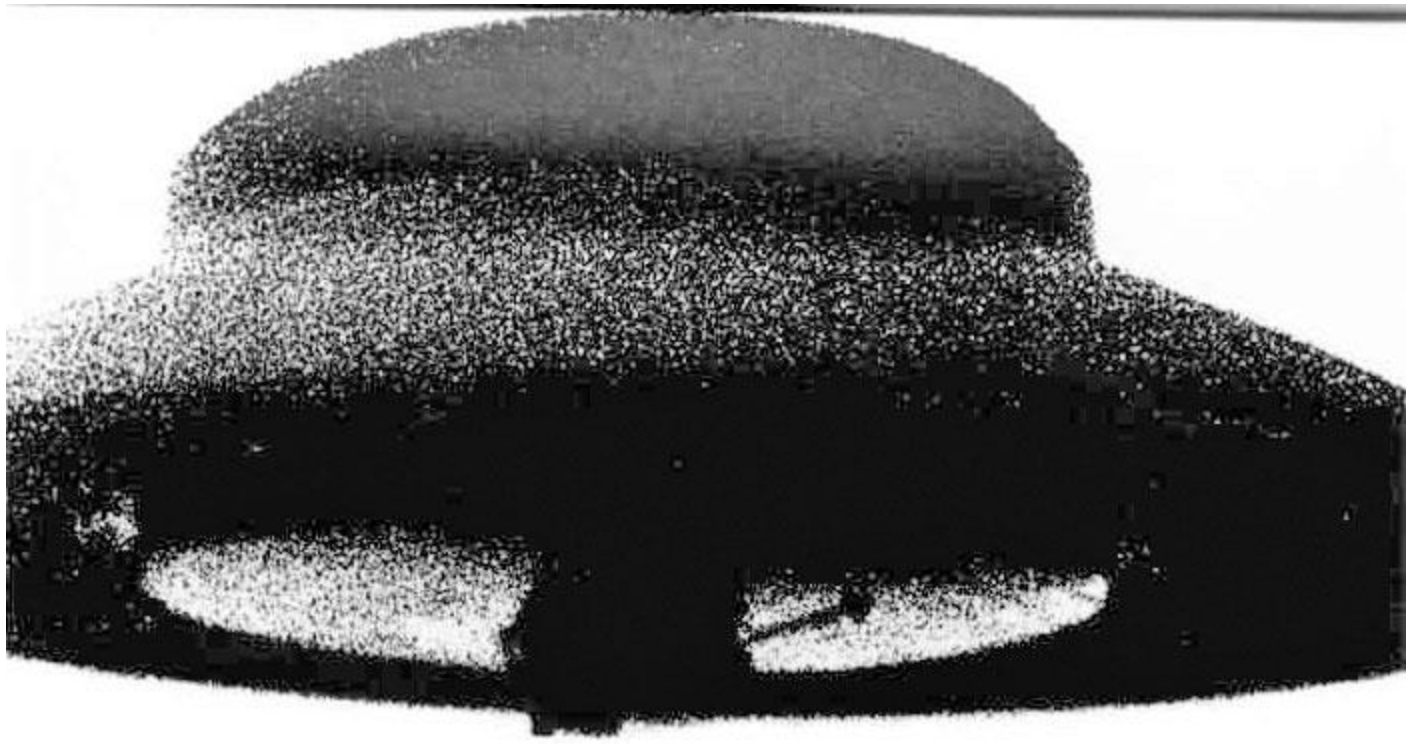

Haunebu-II Vorversion





VRIL-7 in seiner letzten Version. Die Gondelkanone ist abmontiert.  
Dafür gibt es eine »Admiralsbrücke« vorn an der Kuppel und  
hinten einen »Balkon«. Die vier MK-108-Batterien sind eingefahren  
und daher nicht zu erkennen.

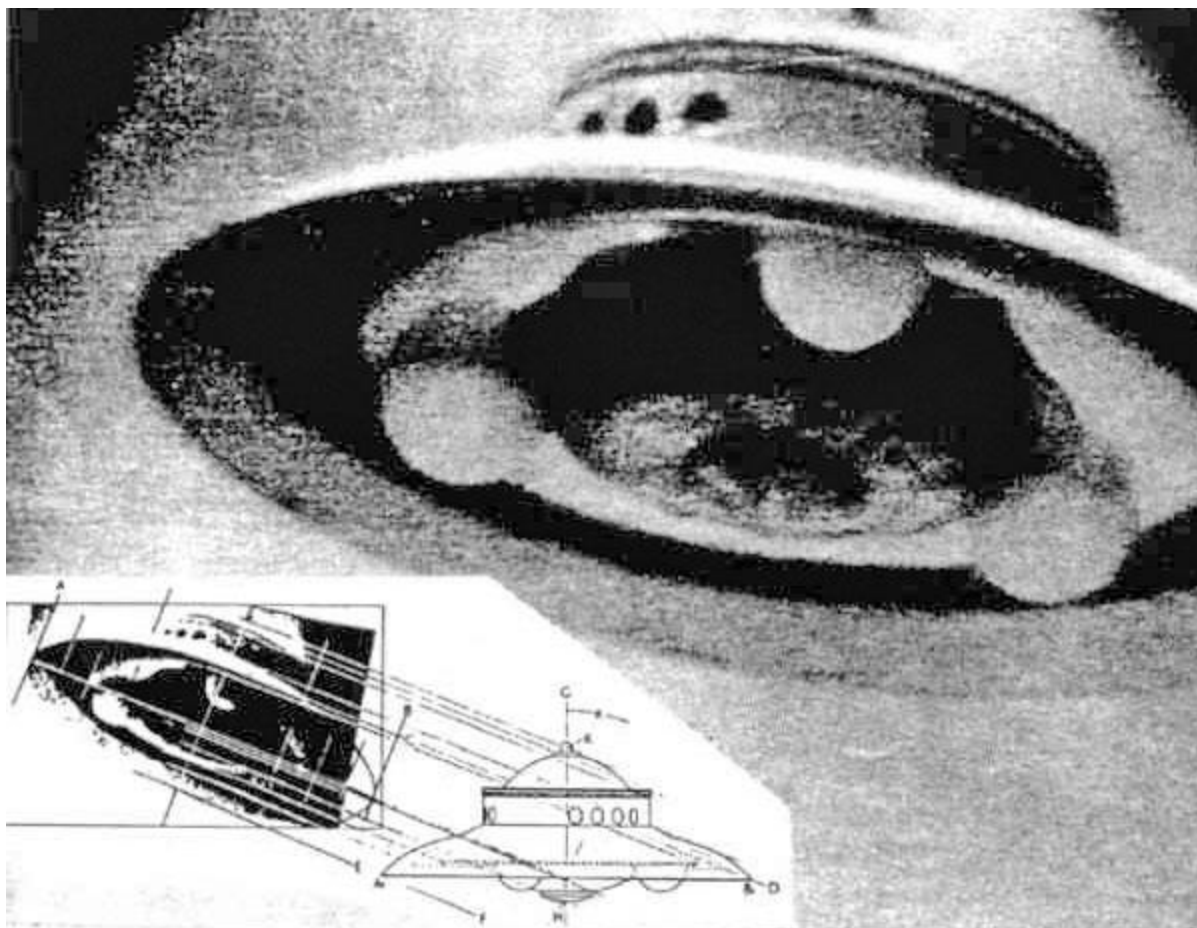

Adamski-Aufnahme vom 13. Dezember 1952. Angeblicher  
»Venusier« flog zufälligerweise in reichsdeutschem Haunebu-II.



VRIL-ODIN, April 1945 mit unten  
erkennbaren Donar-Strahlengeschützen.

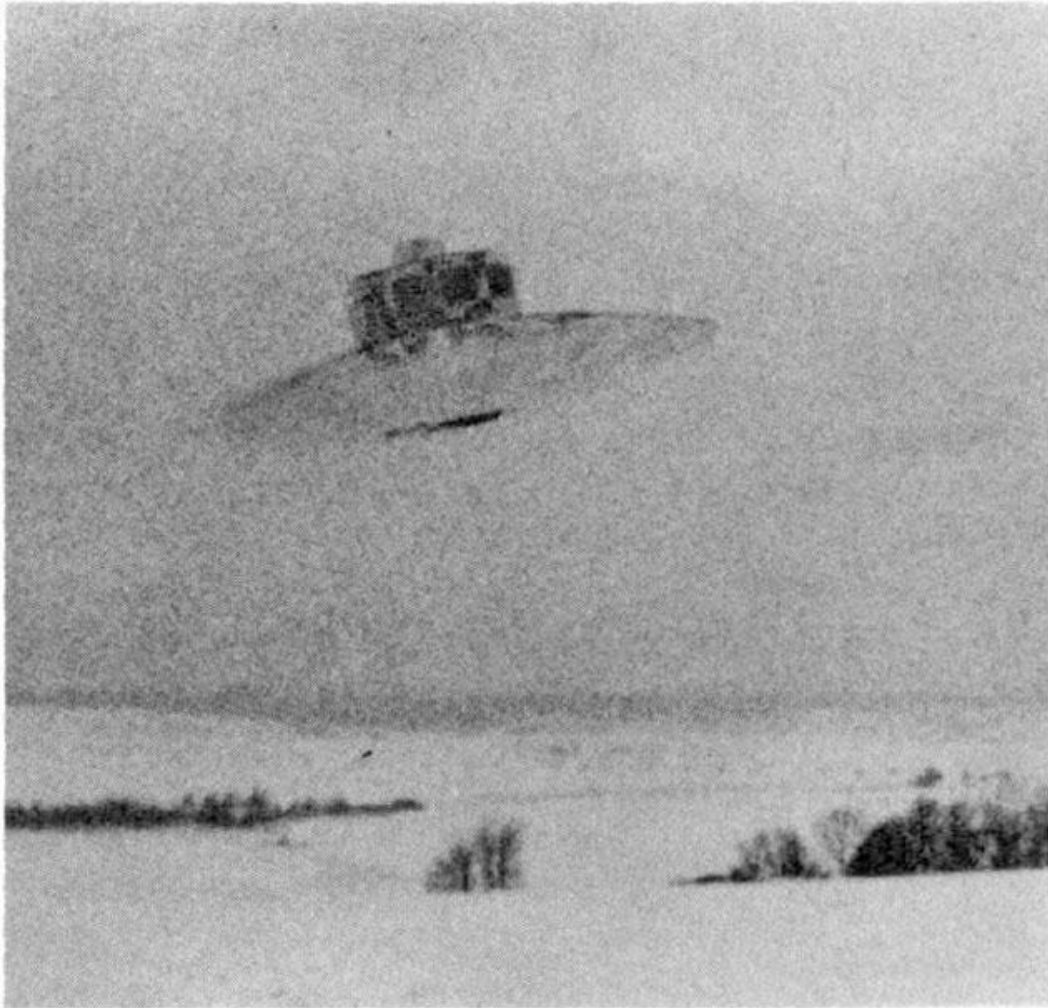

Vermutlich Schauberger-Gerät mit Winter-Tarnanstrich  
(Raum Augsburg 1939)

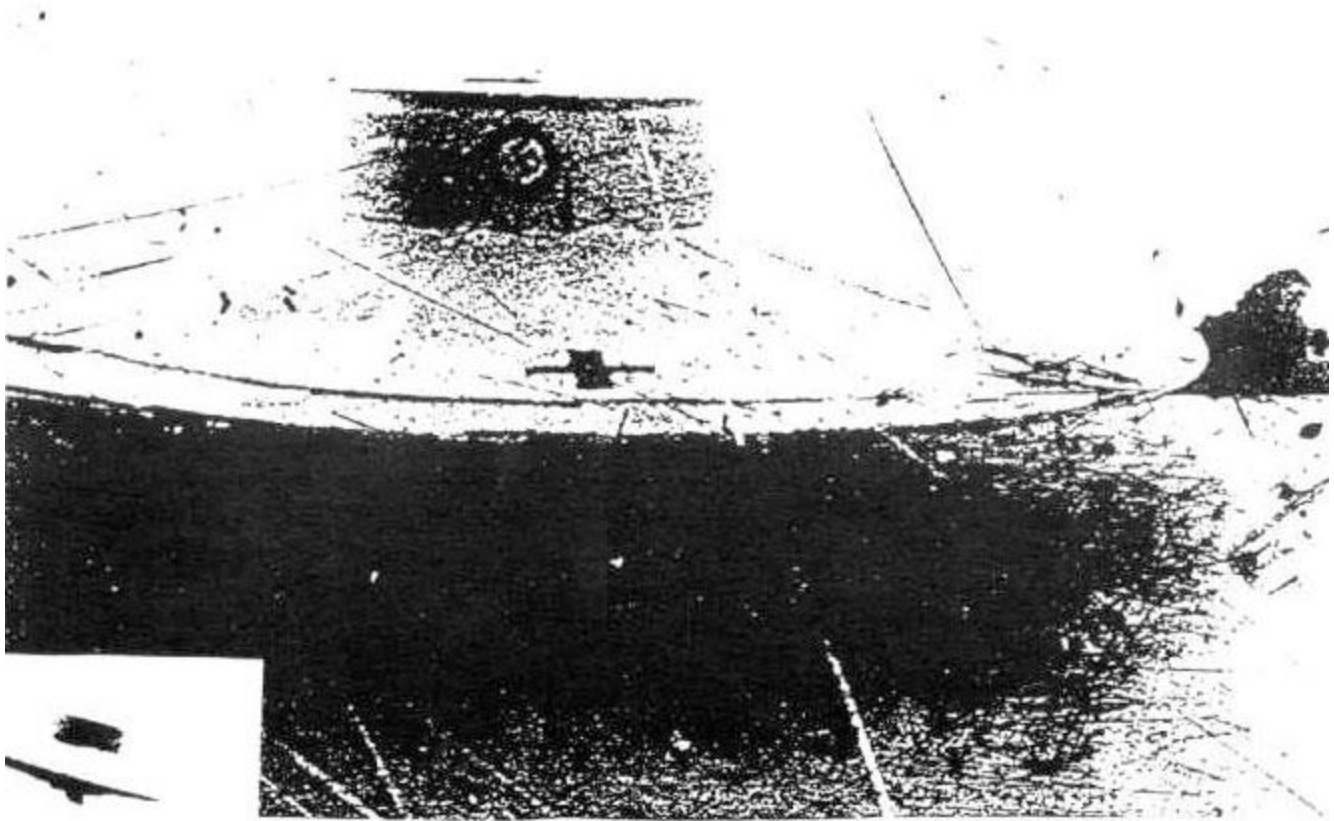
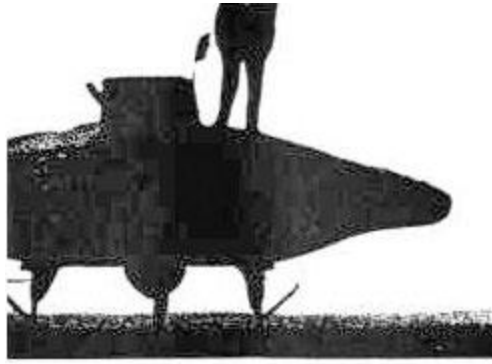

Das Vril-7 vor dem Erstflug, von der HS-126 aus fotografiert.  
Noch ohne Tarnanstrich und mit dem »Exoterischen Signet« der  
VRIL-Gesellschaft (schwarzes Hakenkreuz auf Silbergrund  
im violetten Eichenlaubkranz).

VRIL<sub>1</sub>

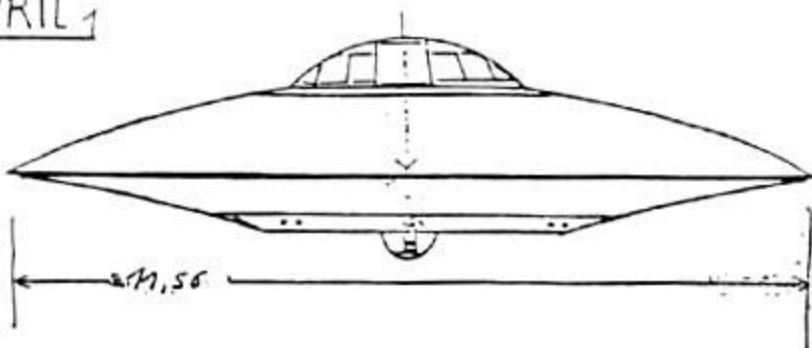

LEICHTE BEWAFFNETE FLUGSCHREIBE (JAGER); TYPE „VRIL“  
(Schumann-Gruppe)

Durchmesser: 11,50 Meter  
Antrieb: Schumann-Levitator (gepanzert)  
Steuerung: Mag-Feld-Impulsor 3a  
Geschwindigkeit: 2900 Kilometer p. Stunde (bisher), bis zu ca. 12000 mögl.  
Reichweite (in Flugdauer): 5 1/2 Stunden ((Plug-Aufladung mittels K3 von Hausen aus, wie erprobt))  
Bewaffnung: 1 8cm KSK, fernsteuerbar, unten, + 2 x MK 108 u. 2 x M: 17  
Außenpanzerung: Doppel-Viktalen  
Besatzung: (je nach Einsatzart) 1 bis 3 Mann  
Weltallfähigkeit: 100 %  
Stillechwebefähigkeit: 12 Minuten  
Allgemeine Flugfähigkeit: Wetterunabhängig Tag und Nacht  
Grundsätzliche Einsatzreife: ca. Sept. 1944, ev. früher.

HAUNEBU III

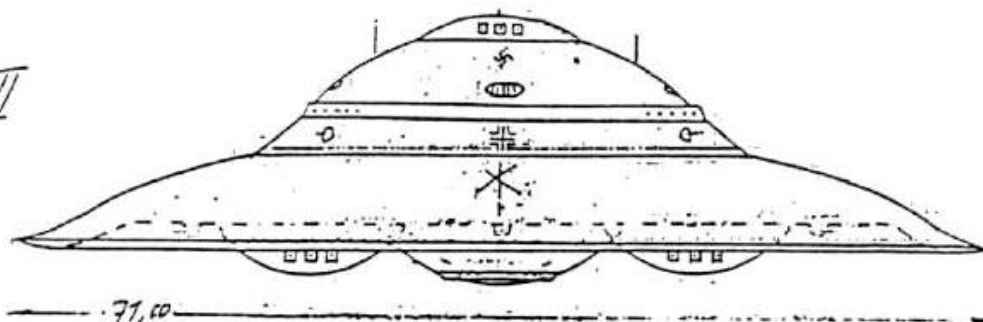

SCHWERER BEWAFFNETER FLUGKREISSEL „HAUNEBU III“

Durchmesser: 71 Meter  
Antrieb: Thule-Tachionator 7a plus Schumann-Levitator (gepanzert)  
Steuerung: Mag-Feld-Impulsor 4a  
Geschwindigkeit: ca. 7000 Kilom.p. Stunde (rechnerisch bis zu 40000)  
Reichweite (in Flugdauer): ca. 8 Wochen (bei S-L-Plug 40% mehr)  
Bewaffnung: 4 x 11cm KSK in Drehtürmen (3 unten, 1 oben), 10 x 8cm KSK  
in Drehringen plus 6 x MK 108, 8 x 3cm KSK ferngesteuert  
Außenpanzerung: Dreisonott-Viktalen  
Besatzung: 32 Mann (erg. Transportverm. max. 70 Personen)  
Weltallfähigkeit: 100 %  
Stillechwebefähigkeit: 25 Minuten  
Allgemeine Flugvermögen: Wetterunabhängig Tag und Nacht  
Grundsätzliche Einsatztauglichkeit: Etwa 1945.

Bemerkung: ES-Y-IV hält den Hinweis für notwendig, daß in „Haunebu III“ ein großartiges Werk deutscher Technik im ersten ist, wegen der allgemeinen Materiallage aber alle Kräfte auf das schnell verfügbare Haunebu II gesetzt werden sollten.  
Gemeinsam mit dem leichten Flugkreisel „Vril“ der Schumann-Gruppe könnte „Haunebu II“ die von Führer aufgestellten Forderungen sicherlich erfüllen.

HAUNEBU II

7. November 1943  
SS-Entwicklungsstelle IV

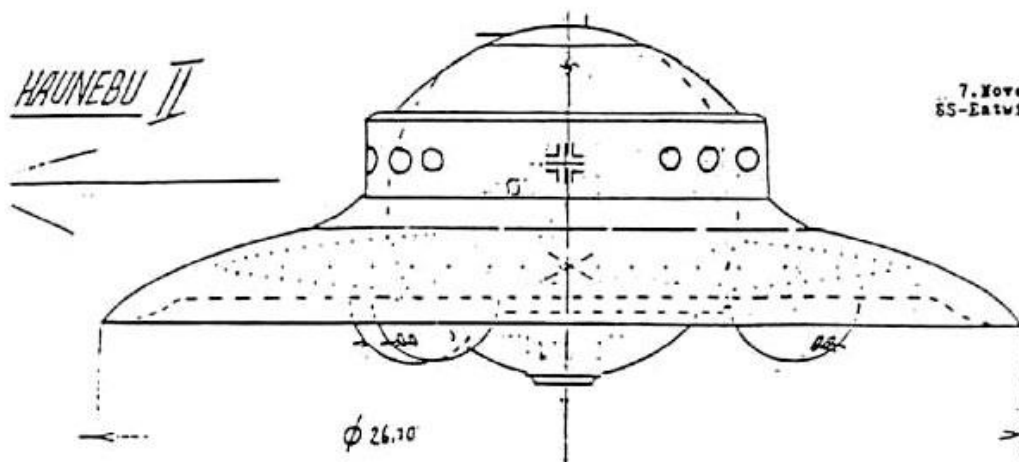

MITTELSCHWERER BEWAFFNETER FLUGKREISEL, TYPE „HAUNEBU II“

Durchmesser: 26,7 Meter  
Antrieb: „Thule“-Tachyomotor 70 (gepaasert; Ø TY.-Scheibe: 23,1 Meter)  
Steuerung: Mag-Feld-Impulser 4a  
Geschwindigkeit: 6000 Kilometer p. Stunde (rechnerisch bis ca. 21000 möglich)  
Reichweite (in Flugdauer): ca. 55 Stunden  
Bewaffnung: 6 8 cm KSK in drei Drehtürmen, unten, eine 11 cm KSK in einem Drehturm, oben  
Außenpassierung: Dreieckst.-„Victoria“  
Besatzung: 9 Mann (erg. Transportverm. bis zu 20 Mann)  
Weltallfähigkeit: 100 %  
Stillschwebefähigkeit: 19 Minuten  
Allgemeines Flugvermögen: Tag und Nacht, Wetterunabhängig  
Grundsätzliche Einsatztauglichkeit (V7): 85 %

Verfügbarkeit „Haunebu II“ (bei weiter gutem Erprobungsverlauf wie V7) ab Oktober.  
Dann Serienherstellung ab Jahreswende 1943/44, jedoch noch ohne verbesserte Kraftstrahl-  
kanonen „Dozer-Tek IIIV“, deren Prototypen nicht vor Frühsommer 1944 angenommen werden  
kann.

Von Führer verlangte hundertprozentige Einsatzreife rüdum kann allerdings  
nicht vor Ende nächsten Jahres erwartet werden. Erst ab etwa Serie 9.

Begleitung zuständige SS-Entwicklungsstelle IV: Die neue deutsche Technik- und  
dabei vor allem Flugkreisel und KSKs wird wegen der noch zeitraubenden Herste-

# 44 Geheimkommando 602

44

Flugkreisel-Erprobung, Stand / Anzahl Erprobungsflüge:

HAUNEBU I (vorhanden 2 Stück)	52	E-IV
HAUNEBU II (vorhanden 7 Stück)	106	E-IV
HAUNEBU III (vorhanden 1 Stück)	19	E-IV
(VRIL I) (vorhanden 17 Stück)	84	(Schmann)

Empfehlung:

Beschleunigen von Abschlußerprobung  
und Produktion „Haunebu II“  
+ „VRIL I“

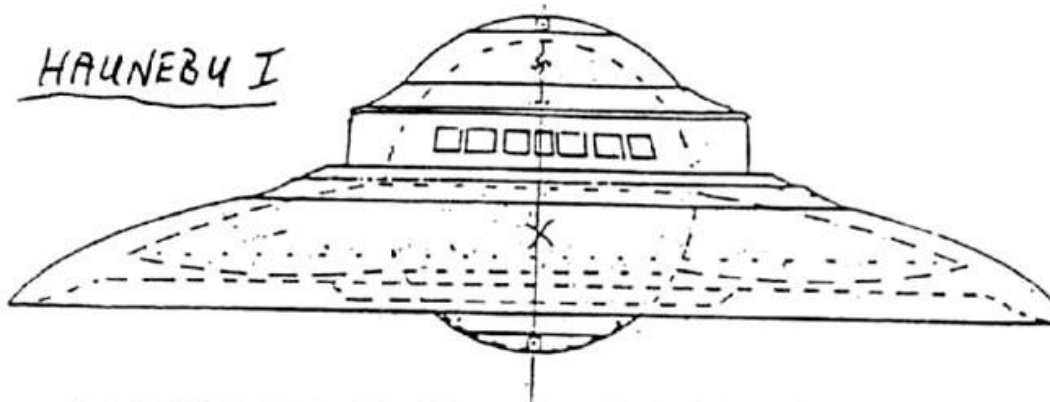

MITTELSCHWERER BEWAPFNETER FLUGKREISEL, TYPE „HAUNEBU I“

Durchmesser: 25 Meter  
Antrieb: Thule-Tachyomotor 7b  
Steuerung: Mag-Feld-Impulsor 4  
Geschwindigkeit: 4800 Kilom.p.Std. (rechner. bis 17000)  
Reichweite in Flugzeit: 18 Stunden  
Bewaffnung: 2 x 8cm KSK in Drehtürmen und 4 x Mk 108, "starr nach vorn  
Außenpanzerung: Doppel-Viotalen  
Besatzung: 8 Mann  
Weltallfähigkeit: 60 %  
Stillschwebefähigkeit: 8 Minuten  
Allgemeine Flugfähigkeit: Tag wie Nacht  
Grundsätzliche Einsatztauglichkeit: 60 %  
Frontverfügbarkeit: Nicht vor Jahresende 44

Bemerkung: Die SS-E-IV hält Konzentration auf bereits im Versuch stehende „Haunebu II“ für sinnvoller als an beiden Typen parallel weiterzuarbeiten. „Haunebu II“ verspricht entscheidende Verbesserungen in nahezu allen Punkten. Höhere Herstellungskosten scheinen gerechtfertigt - besonders mit Blick auf Führer-Sonderbefehl, Flugkreisel betreffend.





VRIL-7 in der letzten bekannten Ausführung  
Bild 1: Auf dem Testgelände in Neu-Brandenburg  
Bild 2: Beim Start nach Traunstein im April 1945

ANDROMEDA-GERÄT

E-V, 2. Dez. 44

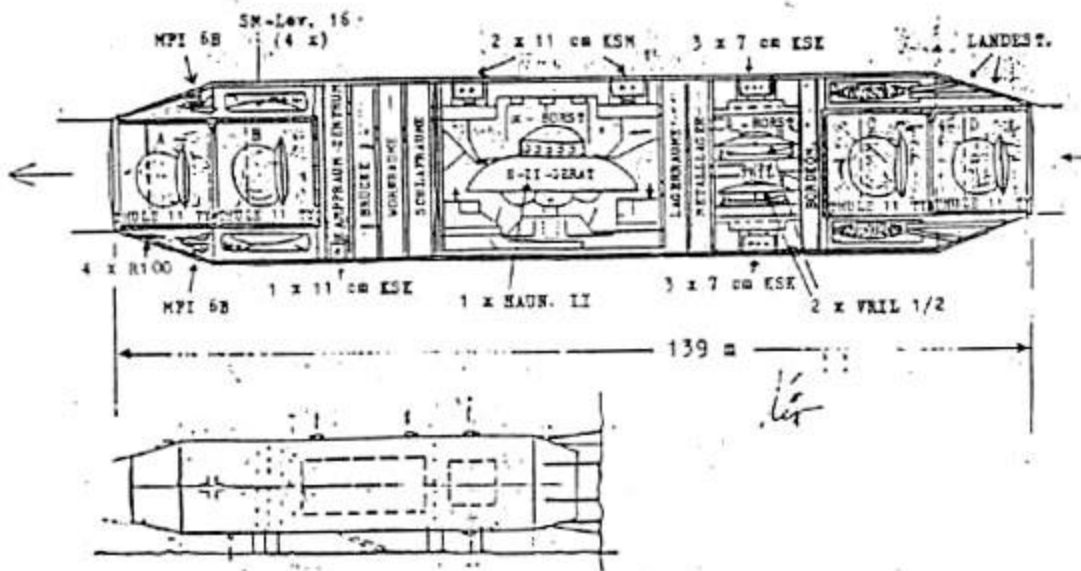

BEWAFFNETES TRÄGER- UND LANGSTRECKENRAGSCHIFF "ANDROMEDA-GERÄT"

- Länge : 139 Meter  
 Durchmesser : 30 Meter (in der Mitte, errechnet)  
 Antrieb : 4 x Thule-Fachgeneratoren II, 4 x Schumann-Levitatoren 16  
 (gepannert)  
 Steuerung : Mag-Feld-Impulsor 6b  
 Geschwindigkeit : Keine Angaben, theoretisch müßten fast 300 000  
 Kilometer p. Sekunde möglich sein  
 Reichweite : Keine Angaben, rein theoretisch unbegrenzt  
 Bewaffnung : 2 x Drehtürme a. 2 x 2 x 11cm KSK,  
 1 x Drehturm a. 1 x 1 x 11cm KSK,  
 2 x Drehtürme a. 2 x 3 x 7cm KSK,  
 4 x R100  
 Außenpanzerung : Unbekannt, vermutlich Dreischicht-Riktalen wie bei  
 Hamnebu-III  
 Besatzung : 130 Mann (errechnete Durchschnittszahl)  
 Vertikalflughöhe : 100 X  
 Stillhaltefähigkeit : Unbekannt, vermutlich 25 Minuten wie bei  
 Hamnebu-III  
 Allgemeines Flugvermögen : Unbekannt, vermutlich wie bei Hamnebu-III  
 wektorunabhängig bei Tag und Nacht  
 Grundsätzliche Einsetztauglichkeit : Unbekannt, doch vermutlich war  
 1945/46 geplant.  
 Rettungsboote : A - Horst = 1 x Hamnebu-II, B - Horst = 2 x Vrill-1 + 2 x Vrill-2

Aus reichsdeutschen SS-Geheimarchiven (Planskizzen, Beschriftung aus Fragmenten rekonstruiert).

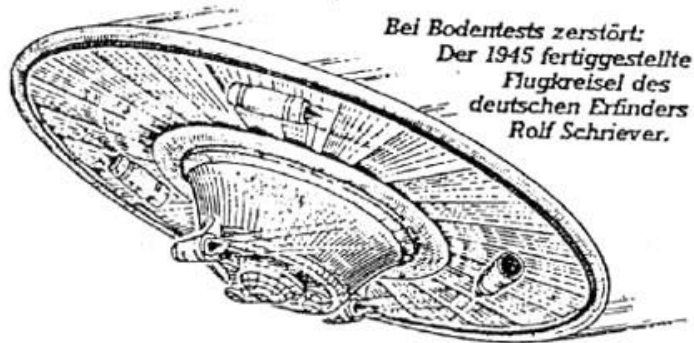
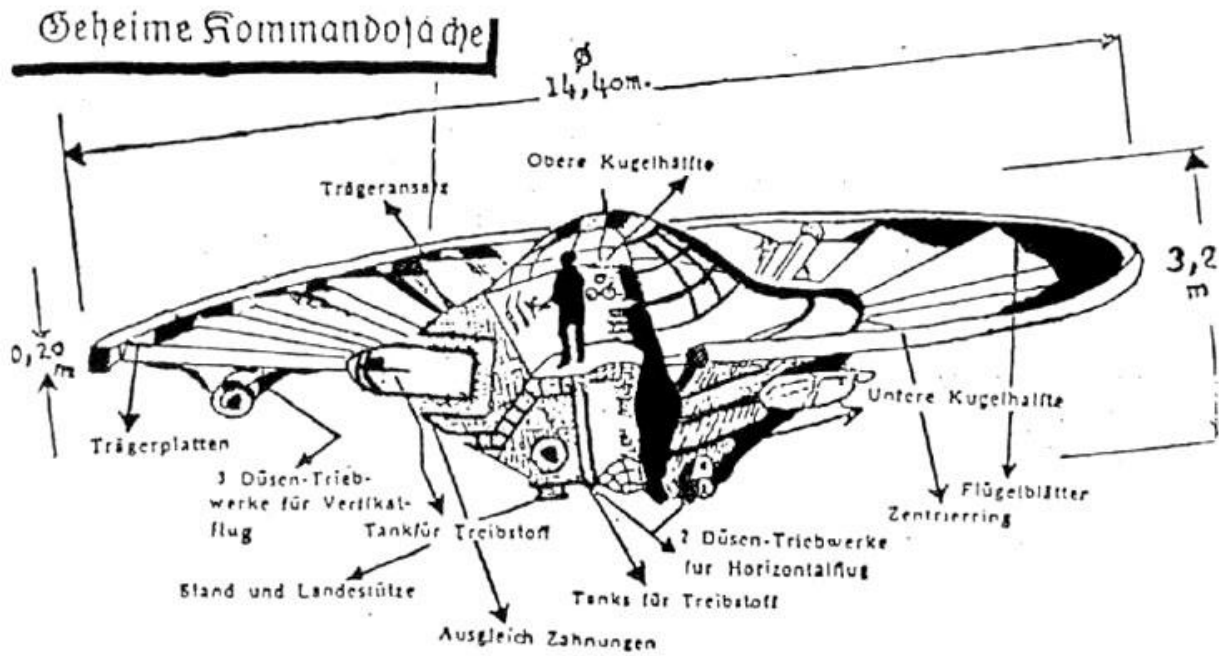

*Bei Bodentests zerstört:  
Der 1945 fertiggestellte  
Flugkreisel des  
deutschen Erfinders  
Rolf Schriever.*

[http://www.bibliotecapleyades.net/ufo\\_aleman/esp\\_ufoaleman\\_gallery.htm](http://www.bibliotecapleyades.net/ufo_aleman/esp_ufoaleman_gallery.htm)

# German Secret Technology

Could There Have Been A Link To Some Early UFO Reports?

from [Rense Website](#)



The Ho-IX  
Maximum Speed 600+ mph



Kenneth Arnold and his  
drawing of what he saw in 1947



Hi-Tech Composite Radar-Absorbing Wings



Flying The Ho-IX In Late 1944

## Wartime Notes On The Ho IX

In a speech before representatives of the aircraft industry, **Reichsmarshal Goering** had announced that no new contracts would be given, unless the proposed aircraft could carry 1000 kg bombs, fly 1000 km/h, and have a penetration depth of 1000 km; penetration depth being defined as the total range.

The Fighter Division requested that the aircraft also be fitted with 30 mm machine guns, something that would lessen the machine's efficiency as a bomber.

We started drawing and calculating without a contract. Our plan was to build two full size prototypes. The initial penetration depth would only be 800 km, since the fuel proof glue necessary for the full wet wing, was not yet available. On the other hand, the smaller fuel load allowed a doubling of the bomb load, so we went ahead and submitted our proposal.

A contract was awarded with the demand that the first flight be made in six months! Since the jet engine was not yet

ready, the first machine would be a glider. The previously deactivated Air Force Command IX was reactivated, and ordered to proceed with the project. Fortunately, the preliminary work that we did without a contract, put us sufficiently ahead, so the six month deadline looked feasible.

There were several reasons for choosing wood as the building material. Duraluminum required more energy to produce; over 3000 KWH, versus less than 3 KWH for wood per ton. The required labor for aluminum production was also much higher; 5000 hr/ton against 200 hr/ton for wood. In addition, aluminum was difficult to find, and skilled sheet metal workers in short supply. Unskilled workers could easily be trained to work with wood.

Typically, a nose rib was built from a triangular piece of spruce, sandwiched between two plywood sheets, all scrap wood. Production time: 10 minutes. After the glue dried, the rib was simply roused out along a master template in less than 5 minutes. The rest of the wing was built in a similar crude fashion, to pave the way for mass production by unskilled workers.

The main box spar contained all cables and control rods, to free the remaining space in the wing for fuel. That, we planned to pump right into the wing itself, without tanks or bladders. To do this, we needed the fuel-proof glue, that could be used to coat the inside surfaces as well. The glue allowed additional gluing to dissolve and adhere to already coated surfaces, which greatly simplified construction.

The skin was very thick: 17 mm, all plywood; three times the necessary strength. On the production aircraft, this would be replaced by two 1.5 mm plywood sheets, with a 12 mm layer of sawdust, charcoal and glue mix, sandwiched in between. The charcoal in this much lighter skin would diffuse radar beams, and make the aircraft "invisible" on radar (STEALTH Technology -ed).

Finally, should a 20 mm shell explode inside the wing, a relatively harmless hole would result, whereas a metal wing would balloon out and lose its lift.

The H IX wing was designed with 3 geometric and 1.5 aerodynamic twist, to give it the desired bell shaped lift distribution with all controls neutral. The Frise-nose on the elevons had proven to be unsatisfactory, so we decided to use blunt nose elevons instead. The sharply enlarged wing root chord served mainly to eliminate the middle-effect. The maximum thickness line (T-4 line) therefore made a sharp bend in the middle, which resulted in the characteristic pointed tail. As this would affect stability, a test aircraft with large aspect ratio, that had the control surface far outside the test area, was needed. The H VI would serve this purpose, while other preliminary tests were made with a H II and a H III.

The H IX V-1 took off right on schedule on March 1, 1944 in Gottingen. The small He 45 towplane barely got off the ground, so test pilot Scheidhauer released, and landed straight ahead, after only a short hop. Five days later, he was off again on a snow covered runway behind an infinitely more powerful He 111. He released at 12000 feet, made an uneventful glide back to the airport, then faced problems during landing when the drag chute did not function. As the end of the runway approached, he retracted the nose wheel, and skidded to a stop with only minor damage.

The second aircraft, scheduled to fly three months later, was awaiting its engines, promised in March. Several weeks passed, and then... Disaster!

The engines arrived with an accessory section added to the case, making the cross section oval, and the diameter 20 cm greater! No one had bothered to inform us! Now, just six weeks before the first flight, we were faced with the problem of fitting an 80 cm engine into an aircraft with a 60 cm hole in the spar! It meant that the wing would have to be made thicker.

To maintain the aerodynamic qualities of our design, we would have to increase the span from 16 to 21.3 meters, and the wing area from 42 m<sup>2</sup> to 75 m<sup>2</sup>. Such an aircraft would never reach the targeted performance, even with higher engine thrust. We chose instead to do the best we could with patchwork modifications. The wings remained the same. Another root rib was added 40 cm outside the original, making the center section 0.8 m wider. The new airfoil was 13% thicker than before, and the bend in the T-4 line became much larger. The thicker center section lowered the critical Mach number to 0.75, or a maximum speed of 920 km/h.

The ratio of movement between the control column and the elevons could be reduced to by the pilot for high speed flight. A small high speed drag rudder was supplemented by a larger one that deployed after the smaller was fully extended. Many parts were scrounged from other aircraft left at the test facility in Gottingen. The nose wheel, for instance, came from the tail wheel of a He 177 heavy bomber. We were even able to use the strut and retract cylinder!

The men of Air Force Command IX did their utmost to complete the aircraft before the end of 1944, sometimes working

more than 90 hours per week.

I remember that **Lt. Erwin Ziller** made the first flight about December 18th, 1944, but his log book indicates that the first flight occurred on February 2nd., 1945. I am quite sure the first flight of the H IX was also his first in a jet. Our leaders had little concern for such risks.

Satisfied with the initial flight, the Air ministry ordered 40 aircraft to be built by the *Goetha Waggonfabrik* under the designation Ho-229.

It appears that the H IX V-2 had flown three or four times before tragedy struck on February 18th. The many versions of the story have a few things in common. The weather was overcast, the ground soft and muddy. The visibility marginal for a test flight, as Lt. Ziller took off, retracted the gear and disappeared. We received a report that one engine had failed, and that the H IX was returning to Oranienburg. Due to the low ceiling, a shallow approach to the airport was initiated. Since the hydraulic pump was on the dead engine, gear and flaps were extended by the emergency compressed air system.

Once down, they could no. be retracted. To maintain his glide slope, Lt. Ziller added power. to overcome the extra drag, and found to his horror that he could "no longer maintain directional control; the fully developed drag rudder unable to overcome the asymmetrical thrust. Rather than lose control, he retarded the throttle to land short of the runway. The aircraft touched down in a field, slid into an embankment and flipped over, crushing its pilot.

The US Third US Army Corps reached the Goetha plant on April 14th 1945. Here they found the H IX V-3 intact and nearly completed, and also the V-4, V-5 and V-6 in various stages of completion. The Ninth US Armored Division found the H IX V-1 in good condition near Leipzig. Its fate is unknown.

The H IX V-3 was later shipped to USA, and is now in the Smithsonian collection, awaiting restoration.

[More amazing pictures of the Ho IX](#)

## German Secret Technology

## UFO Secret History

by **Tim Matthews**

May 1998

Over the last few months new information has emerged relating to the terrestrial origins of flying saucers. This goes to the heart of modern-day UFO research and because we neither claim that UFOs are of ET origin nor that flying saucer sightings are explainable as evidence of natural phenomena or simply misidentifications of mundane phenomena we are under attack from all sides. Nevertheless, the evidence we have put forward has encouraged many researchers to become engaged in a debate that some people might have hoped had gone away.

The fundamental point to make is that, according to a great deal of UFO literature, despite the best efforts of researchers to identify the objects described in UFO reports there remains a hard core, perhaps 1-2%, that are said to represent 'true' or 'real' UFO phenomena. Therefore the evidence suggests that many of this core of 1-2% of sightings relates to structured craft of 'unknown' origin. In this case, I am writing about flying saucers - often quite small, seemingly constructed of some metallic substance - occasionally described as 'brushed' aluminum:

Take for example the McMinnville, Oregon, photographs taken by **Paul Trent** on 11th May 1950. These are some of the best examples of a saucer photograph and extensive analysis has shown that:

This is one of the few **UFO** reports in which all factors investigated, geometric, psychological, and psychical, appear to be consistent with the assertion that an extraordinary flying object, silvery, metallic, disk-shaped, tens of meters in diameter, and evidently artificial, flew within sight of two witnesses.

This is very important UFO research which shines new light on this most 'elusive' mystery of the Twentieth Century. Perhaps it is time for a little demystification.

We suspect that 'flying saucers' were developed, to some extent in parallel, on either side of the Atlantic during the Second World War. This realization, or understanding, is becoming increasingly a focus for research even though a long period of time has passed since those developments took place. Our research might be said to represent a 'small voice of calm' within the UFO community, whose increasingly shrill calls for Western governments to 'come clean about UFOs and aliens' tend to obscure the truth about flying saucers.

To others, our research is an example of the 'Federal Hypothesis', that which states that:

The answer seems to be that, in the USA at least, UFOs are controlled not so much by an intelligence as by an Intelligence Agency.

In the first place, it is certainly not the case the new generation of man-made flying saucer advocates are apologists for Nazism as is suggested by the skeptics who claim that because some nazi saucer researchers are of dubious political persuasion then all subsequent research is invalid.

This type of guilt by association is, of course, a rather ineffective way of arguing with the evidence.

Secondly, debunkers argue that because some supposed sightings of flying saucers have been explained or that they are explainable then all sightings should be called into question. The reader has seen that there are impressive UFO sightings that clearly relate to structured circular craft and that these have been reported from around the world with a concentration upon the USA - a fact which surprises few researchers.

Despite the argument that German scientists had no more advanced technology than the allies, one American was very clear as to the technical achievements of nazi scientists: Major General **Hugh Knerr**, Deputy Commanding General for Administration of US Strategic Forces in Europe, wrote to Lieutenant General **Carl Spatz** in March 1945:

Occupation of German scientific and industrial establishments has revealed the fact that we have been alarmingly backward in many fields of research, if we do not take this opportunity to seize the apparatus and the brains that developed it and put this combination back to work promptly, we will remain several years behind while we attempt to cover a field already exploited.

It is possible to look into the area of German flying saucers without reference to so-called established sources. These authors are often targeted for attack by skeptics and include **Allen Harbinson**, who has contributed to the subject through his exciting series of *Project Saucer novels* and the more recent non-fiction paperback *Projekt UFO* and Renate Vesco, whose research appeared in the late 1960s as a paperback with the title *Intercept But Don't Shoot* and later as *Intercept UFO*.

**Vesco** appears to have cooperated with hidden knowledge writer David Hatcher Childress in the production of *Man-Made UFOs - 50 Years of Suppression*. In addition to these books, which are interesting though imperfect in their presentation (and omission) of the evidence, there are also two books written in the 1970s by **Ernst Zundel** under the pseudonym Mattern Friedrich which were popular for a short time within the far-right political community and may still be available.

**Zundel** himself is a controversial figure for a number of obvious reasons which include support for anti-Semitic groups, his publication of books and magazines denying the holocaust, and his links with most of the influential neo-Nazi groups in Germany, Britain, the USA and Canada. His most important book on the subject of German flying saucers is entitled *UFOs: Nazi Secret Weapons*.

Despite the fact that Zundel is a character with whom we have little or nothing in common from a political point of view, his espousal of far-right politics neither means that every piece of information in his two books is wrong nor that they should be ignored. It is important to realize that Zundel's main purpose in writing and dissemination these books was not primarily an attempt to advocate the supposed superiority of Nazi technologies but to make a fast buck. In short, Zundel did it for the money, and he has made it quite clear that these publications are, in his view, not to be taken 100% seriously. The skeptics point to Zundel as a major source on German secret projects despite the fact that there are several other books and articles, including primary material, that have no link with such questionable politics.

Where we have a situation where skeptics will use any tactic, we can expect them to claim that any use of contemporary German-language material is evidence of apology for nazi war crimes. This is not the case although we do not any longer intend to look over our shoulder every time we mention German pre-war or wartime technology. We research this subject in order to shed new and important light on the fundamental reality of man-made flying saucers.

The final point to bare in mind regarding this subject is that the victors of any conflict have a head start in writing the history books and, in the case of the immediate aftermath of the Second World War, burying or spitting away evidence, documents, plans and blueprints, actual technology and a variety of other materials that the allies did not, and do not, want the public to know about - for a variety of reasons that may become apparent.

Despite the fact that the man-made origins of flying saucers are of the greatest implications in terms of our understanding of postwar history, *man-made UFO researchers* have to some extent been deliberately ostracized and smeared.

Nevertheless, a great deal of new information has emerged in recent years and there is still more to come. The

suggestion that fifty years after the end of the Second World War new information cannot emerge because this period has been the subject of the most intense scrutiny is an illogical one. For any number of reasons information can stay buried and, beyond mere speculation, we know that files relating to the Second World War remain locked in the deep dark vaults of the Public Records Office in Kew, London.

Remember this - records are routinely held for 30 years and can be held for 50, 75 and 100 years after the event. By the time they emerge they may have been altered, edited or sanitized to protect the identity of those responsible for the implementation of policy. One simple example that comes to mind is the emergence in recent years of new and credible information about the German nuclear research program underway during the Second World War.

Much of this has been the result of research undertaken by **Philip Henshall** who has also contributed a great deal to our understanding of advanced German weapons projects through his books on the rocket research facilities at Pennemunde on the Baltic coast.

Even before the allies landed in Normandy in June 1944 special groups of language and technical research specialists had been organized in order to recover as much of the technological hardware and research data relating to advanced German weapons. This effort was dedicated to getting hold of much more than data on the V2 rocket - the most obvious and well-known example of German scientific expertise. Already, through an intelligence estimate passed to the allies via a Norwegian source and known as *the Oslo Letter*, the allies were aware of other weapons under development and in operation by axis powers.

These included radio-controlled bombs, huge guns, rocket launchers, new radar systems, long-range bombers and torpedoes. It would seem that they might also have been interested in a circular-wing aircraft with *Vertical-Take-Off-and Landing (VTOL)* capabilities. In short, an early and relatively primitive flying saucer..

In order to make some progress in terms of this research it seems necessary to avoid using the standard sources - **Vesco** and **Harbinson** - even though some of their information is valid as we have seen. Other sources are equally intriguing. One source indicates that from the mid 1930s there was significant interest in both Vertical-Take Off and Landing (VTOL) and circular wing aircraft.

This led to a number of designs one of which was the Focke-Wulf VTOL.:

Professor **Heinrich Focke** was particularly interested in emerging helicopter and autogyro technologies and was involved in the design and production of the FW6, Fa223, Fa226, Fa283 and 284 models during the war. The creation of the jet engine encouraged him to design a propulsion system known as the turbo-shaft still used in most helicopters today. In 1939 he patented a saucer-type aircraft with enclosed twin rotors. This was a revolutionary development described as follows:

The exhaust nozzle forked in two at the end of the engine and ended in two auxiliary combustion chambers located on the trailing edge of the wing. When fuel was added these combustion chambers they would act as afterburners to provide horizontal propulsion to Focke's design. The control at low speed was achieved by alternately varying the power from each auxiliary combustion chamber.

This was by no means the only circular aircraft.

Another similar aircraft was the troubled AS6 partly designed by the leading aviation expert in Germany **Dr. Alexander Lippisch** whose work at the Göttingen Aviation Institute was legendary and whose impact upon postwar 'UFOs' cannot be underestimated. His revolutionary DM series of small triangular aircraft were built and flown in conjunction with students at Darmstadt and Munich Universities (hence the DM prefix) and used rocket propulsion. The plans for these were transported to the USA after the war. His most advanced design was undoubtedly the Lippisch Supersonic Flying Wing which, although never built, strongly hinted at the triangular 'UFOs' of the 1980s and 1990s.

The information about the AS6 (V1) emerged in an article written by **Hans Ebert** and **Hans Meier** based to a certain extent upon information and a photograph provided by German aviation expert **Wolfgang Spate**. (Spate was the former Commander of Operational Test Unit 16 during the War and more recently recognized as a leading aviation expert. He served in the refounded postwar Luftwaffe.) The article, entitled *Prototypen - Einselschicksale deutscher Flugzeuge, Der Kreisflieger AS6 V1*, was included in a the respected *Luftfahrt International* in 1980.

In certain respects the AS6, built by Messerschmidt, was based upon similar thinking as the Zimmerman V173 flying flapjack - designed for use by the US Navy from 1942. The flying flapjack was far more successful and developed at the Chance-Vought works in Connecticut and despite its' supposed limitations was a propeller-driven aircraft designed to be flown from an aircraft carrier, hence the need for *Short Take off and Landing (STOL)* capability. The flapjack was able to fly at low speeds of approximately 40mph. The flight envelope was 40-425 mph and a more advanced version, the



XF5U1, was also tested.

One other important feature of these circular wings was an early 'stealth' capability. The *Horten brothers* Reimar and Walter, known for their many successful flying wing prototypes, had developed a composite wing made of plywood held together by sawdust, charcoal and glue intended to absorb radar waves for use in their HIX model.

In 1946 Chance-Vought was using a similar technique. A skin called 'metalite' was used in one of its' circular wings. **Thomas C. Smith**, former President of the Woodstream Corporation and a Penn State graduate engineer at the time, reported that he had seen a 'flying saucer' (XF5U1?) taking off vertically from the Chance-Vought facilities in Stratford, Connecticut at the time and that it had used this composite. This was reported last year.

This means that the circular wing or 'flying saucer' had a limited stealth capability years before the use of Radar Absorbent Materials was considered for other advanced aircraft.

We can certainly dismiss all the nonsense so prevalent in various media on the subject of German flying saucers which relates to the development of circular-wing aircraft as the result of occult or mystical beliefs. The truth is that the circular wing was designed for technical reasons: circular and flying wing designs are inherently stronger and are easier to build.

Whilst it is likely that any information relating to the limited AS6 would have been taken by the allies for examination at a later date it would seem that there is some evidence to suggest that a more advanced jet-powered flying saucer was at least designed, if not built, from around 1943 onwards. The first source is Flight Captain **Rudolph Schriever** who came forward in 1950 and claimed that he had worked with a small team at facilities near Prague with a view to developing a flying saucer-type vehicle. The Schriever story first emerged in *Der Spiegel magazine* dated March 30th 1950 entitled *Untertassen-Flieger Kombination*:

A former Luftwaffe captain and aircraft designer, Rudolph Schriever, who says engineers throughout the world experimented in the early 1940s with flying saucers is willing to build one for the United States in six to nine months. The 40 year old Prague University graduate said he made blueprints for such a machine, which he calls a flying top, before Germany's collapse and that the blueprints were stolen from his laboratory. He says the machine would be capable of 2,600 mph with a radius of 4,000 miles, Schriever is a US Army driver at Bremerhaven.

This is a most credible story. **Schriever** claimed that the model built for testing was completed in 1944 with a view to flying it in 1945. Nevertheless, the Russian advance ended any hopes of a test-flight.

A 1975 *Luftfahrt International* report took these claims seriously and noted that after Schriever's death in the late 1950s papers found amongst his belongings had included technical drawings of a flying saucer.

Schriever seemed to argue that although a saucer had existed it had not flown. This is contradicted by a possible eyewitness, **George Klein**.

He claimed after the war in an interview, given on November 18th 1954 to the Zurich-based Tages Anzeiger, that he had actually seen a flying saucer test on 14th February 1945 and that the craft had performed remarkably well reaching an altitude of 30,000ft in 3 minutes as well as a high speed of hundreds of miles and hour. Despite the fact that subsequent information leads us to conclude that a jet-powered flying disc was developed at the end of the war Klein spoke of a ray-guided disc. Despite this fanciful claim some of the things he said made more sense. For instance, he claimed that some of the work on the flying saucers had taken place at Pennemunde.

Pennemunde was of course the focal point for the development of the A4/V2 rocket. Interestingly, **Klein** also claimed that the necessary stability for the saucer had been attained through the use of a gyroscope. This is exactly the method used in the later German rockets developed by the *Von Braun/Dornberger team*. What is more, the entire rocket effort moved to the Mittlewerke underground facilities near Nordhausen in the Harz Mountains. It is claimed, by several other witnesses, that a flying saucer was tested in the vicinity of Kahla In Thuringia in early 1945.

The evidence presented above seems to have been taken seriously not only by mainstream magazines and national newspapers in the 1950s but also by the author of *Brighter Than A Thousand Suns*, **Robert Jungk**. This is an authoritative and historical account of the development of the Atomic Bomb written by a respected author. The book itself, still available and published by Harcourt and Brace, received critical acclaim from Bertrand Russell, amongst others. A section of text on page 87 of the paperback edition states:

The indifference of **Hitler** and those about him to research in natural sciences amounted to positive hostility.\*

The accompanying footnote reads as follows:

\*The only exception to the lack of interest shown by authority was constituted by the Air Ministry [Reichs Luftfahrt Ministerium or RLM, TM]. The Air Force research workers were in a peculiar position. They produced interesting new

types such as the Delta [Lippisch and Horten, TM] ..and flying discs. The first of these flying saucers, as they were later called - circular in shape, with a diameter of some 45 yards - were built by the specialists Schriever, Habermohl and Miethe. They were first airborne on February 14th 1945, over Prague and reached in three minutes a height of nearly eight miles. They had a speed of 1250mph which was doubled in subsequent tests. It is believed that Habermohl fell into the hands of the Russians. Miethe developed at a later date similar flying saucers at A.V Roe and Company for the United States.

This use of the original Schriever story is interesting if only because the author felt that the information was good and warranted exposure. Given the nature of the book, we might well ask whether the author had any other information that supported the claims made as to the characteristics of the circular aircraft. It is up to the reader to decide whether these claims make any sense at all and more importantly, how this might affect our understanding of flying saucer history. Until recently, it would have been rather safer and perhaps more sensible to argue that although various prototype saucers existed in whatever form they were never tested. Safety is often the best policy given the shark infested waters of modern-day UFO research. However, thanks to three years of painstaking research by UK astronomy, aviation and photographic expert Bill Rose which included on-site research in Germany, Canada and America we now know a great deal more. Initially Rose felt, like many skeptics, that the evidence for German flying saucer (and UFO) reality was very shaky.

Nevertheless, and without reference to the UFO community in his personal quest for the truth, he was able to use his expert technical knowledge to follow up leads and to make significant progress.

First of all he was able to discover that **Dr. Walter Miethe**, whom all sources agree was involved with Schriever, **Klaus Habermohl** and **Giuseppe Belluzzo** (an Italian engineer) had been the Director of the saucer program at two facilities located outside Prague. In May 1945, after testing of the prototype had taken place, both Miethe and Schriever were able to flee in the direction of Allied forces. Habermohl was captured by Soviet forces and spirited East where he ended up working on various aviation projects quite probably at facilities located outside Moscow.

It would seem that Klaus Habermohl was the man who developed the radial-flow jet engine, described in various articles as a system of adjustable nozzles, of great significance just ten years later. (Radial-flow allowed for VTOL performance and used the little-known *Coanda effect*.) Rose learned that not only had test flights taken place but that film footage of these had been taken. This had always been rumored and makes perfect sense given the nazi fetish for keeping records on everything. The footage, of good quality, has subsequently been stored in a secure location and shown only to a handful of people.

Rose was shown some stills taken from the original film and given his expert photo-technical background concluded, after careful consideration, that this was probably real and historical footage. He calculated that the craft was around half the size claimed in Klein's report. The saucer, rather less contoured and sleek than postwar artists' impressions might suggest (and unlike **Bob Lazar's S4 Sports Model!**), was perhaps 75ft in diameter. The saucer was shown in flight above the runway over the heads of a couple of observers.

Although this is in itself of the greatest significance other more contradictory evidence has emerged. One of the people that Rose met had good information about the February test flight and was able to confirm that several people had seen the test-flight - as we might expect. It was said that Schriever himself had piloted the test craft. This does seem sensible (and logical) given Schriever's background in the Luftwaffe - although it is at variance with his own account.

One can only speculate as to why this may be. It should be pointed out that the performance characteristics of this jet-powered aircraft have probably been exaggerated and although it might have been technically possible given further research and development to approach supersonic speeds, this was almost certainly not achieved in February 1945. Finally, it seems as if Klein himself was centrally involved in the saucer project and may indeed have had responsibilities for procurement.

We know a little more about Dr. Miethe. One of the important pieces of information came in the form of a rare group photograph showing various young German scientists in 1933. The photograph shows **Werner von Braun** and **Walter Miethe**. It would seem that these two knew each other well. During the War various lists of wanted German scientists were drawn up. One of these was the *Black List* used by *Counter Intelligence Corps and Combined Allied Field Teams (CAFT)* as they moved through Germany from 1944 in order to help them get hold of the important scientific personnel.

Dr. von Braun was certainly at the top of the list and if Miethe and he were old friends and had cooperated on early rocket projects, there is little doubt that Miethe would have been a target too. Nevertheless, his work near Prague put him out of reach and only through Miethe's own efforts did the allied teams get their hands on him.

The immediate postwar is critical to an understanding of both the myth and reality of flying saucers or UFOs. One thing

is for sure: hundreds of nazi scientists as well as intelligence personnel, many of whom had been involved in the abuse of thousands of slave labourers, were transported via Operation Paperclip (so named after the original designation Overcast was compromised). Many of these technical personnel were sent initially to Fort Bliss in Texas. From here they were farmed out, according to their ability and expertise, to the many advanced scientific facilities dotted throughout the USA and Canada.

Interestingly, *Chance-Vought*, builder of both the V173 and XF5U1 prototypes, moved its' base of operations to Texas in early 1947. The company seems to have been less than candid at this early stage about the true nature and extent of its' involvement in flying saucers. The official story of the demise of the XF5U1 - that there was no interest in developing a propeller driven aircraft from 1948 after the advent of jets - is now in question. It would seem that a jet-powered version using Allison J33 engines was actually test-flown at Muroc Field in 1947.

The history books tell us that the propeller-driven version was to be tested here before the program was cancelled. Nevertheless, our understanding of the situation is that technical drawings of the jet-powered version have now surfaced through a series of *Freedom Of Information Act* requests. Given the overall design of this craft and the many sightings of flying saucers in New Mexico and the Western seaboard in the late 1940s it is safe to conclude that the sightings related to a saucer of terrestrial origin with limited performance characteristics.

The best of these are arguably the sightings over Muroc Field reported by serving military personnel on 8th July 1947 and the subject of subsequent internal investigation which revealed that the object seen was disc-shaped moving at around 300 miles per hour.

The military witnesses **Gerald Neuman** and **Joseph Ruvalo** stated that in their opinion this was a man-made aircraft travelling at only 300 miles per hour and this view was supported by a civilian witness named Lenz.

Similar objects were seen - many of them in and around the *White Sands Proving Ground* where we know for sure that many of the Paperclip scientists were working. It is probable that at this stage people were seeing a US-built circular-wing aircraft and only gradually, in the late 1940s/early 1950s, were German advances incorporated into the overall saucer program. After all, military historians agree that a huge amount of material was recovered from facilities in Germany and it took a great deal of time and effort to collate this.

We know both from **Gerald K Haines** report and from the recently declassified (1995) Air Technical Intelligence Centre report on *Project Silver Bug* that prototype saucers were actually test-flown (obviously before 1955) in order to determine their usefulness in terms of future dispersed base operations designed to reduce vulnerability to Russian air attack. Hence the possible use of VTOL aircraft from camouflaged facilities.

I also suggest that the sightings reported by military personnel during the 1952 '*Operation Mainbrace*' may have related to a similar flying saucer prototype. It seems to me that such a major exercise would offer an excellent opportunity for testing and evaluation.

Given that we now believe that **Klaus Habermohl** designed the first radial-flow engine, a revolutionary development by any standards (even today) in 1943, it is likely that within a few years progress had been made although the advanced nature of the engine made only for slow progress. The incorporation of a radial-flow engine using the Coanda Effect in combination with a circular wing made this a weapon worth keeping secret.

The jet-powered circular wing and the Silver Bug craft were two out of three variations upon a theme. There were two Silver Bug prototypes, Projects Y and Y2, the first using a standard axial flow engine, the second the more advanced type. Project Y was also designated P724 (P being the AV Roe Company project number) and was in fact a hybrid saucer/AVRO Arrow (the Arrow was an advanced supersonic aircraft cancelled in the early 1960s supposedly after the US pressurized on the Canadian government).

The existence of projects beyond the limited **Avrocar** adds further weight to the suggestion that Avrocar was little more than a cover for much more advanced aircraft. Let us be quite clear on this point: Both Projects Y and Y2 were separate and distinct from the Avrocar and in fact the evidence further suggests that the craft test-flown near Prague in February 1945 was actually more advanced! It is interesting to note that proponents of the extra-terrestrial hypothesis tend to use the failed Avrocar program as evidence that flying saucers must be of ET origin. We must now dismiss such misleading conclusions.

On a separate note and in view of the suggestion that underground facilities have been built in the postwar period it now seems that in certain cases these were used to house small numbers of flying saucer-type aircraft. This is not to say that they were located in the wilds of Canada but more likely within the *White Sands Proving Ground* and later on or near the Groom Lake facilities in the Nevada Desert. Whilst the man-made reality of flying discs has been hijacked by **Bob Lazar**,

**John Lear** and a generation of US Ufologists, it seems as if the remote nature of Groom dry Lake bed was considered both with flying saucers and the U2 spyplane in mind.

There is no doubt that all kinds of weird and wonderful aircraft are tested from Groom Lake but in terms of flying saucers it seems as if they may have arrived in 1959/60. The facilities there, although home to secret **CIA** and possibly *National Reconnaissance Office (NRO)* aircraft have primarily been operated as US Air Force Flight Test Centre Detachment 3 (AFFTC Det 3). AFFTC is headquartered at Edwards Air Force Base, formerly Muroc Field. It is vital for the reader to understand that Silver Bug, Project Y and in fact all the saucer programs we now know about had very strong links with the US Air Force.

In fact, **Dr. Miethe** worked primarily for the USAF even though he was sub-contracted to AVRO - possibly as a cover for the real efforts underway in the USA whereby the design work was undertaken in Canada and the majority of test flights within US borders. Having said that there was a mention of Canadian saucers made in several newspaper articles and books in the early 1950s. Even **Donald Keyhoe** notes a conversation with an informed source on this subject in his populist *Flying Saucers From Outer Space* (1953).

More interesting was an article featured in *Look magazine* dated June 14th 1955 (Volume 19) which featured a design study for a flying saucer produced by **Thomas Turner**, a British aeronautical engineer with Republic Aviation Corporation. It would seem that Turner might have had some knowledge of Silver Bug if only because his proposal for a flying saucer was almost exactly the same as the ATIC aircraft. In addition Turner's proposal includes use of the [Coanda effect](#) and the placing of a pilot in a prone position in order to allow for high acceleration and quick turns.

Both these would seem to come from an understanding of German projects the skeptics deny existed. Other notable features of the article include the use of language, for instance the following which reminds us of the introduction to the *Project Silver Bug* report:

Future airports built for vertically rising flying saucers would have no need of the long, vulnerable runway's today's fighters require. The complete operation could go underground. Tunnels with take-off shafts set into the ground, complete with maintenance bays, fuel and crew quarters, would be bomb-proofed shelters for a saucer squadron. The shafts would be sealed after take-off for camouflage and protection.

This sounds rather like the need for dispersed base operations discussed in the Silver Bug document. I further suggest that we now have a possible primary source for **Renate Vesco's** insistence that flying saucer bases were situated in the wilds of Canada in a 'remote area of British Columbia'. A picture of such a saucer base is shown in the article and reproduced in this report. The quality is not that good: The article quoted Brigadier General **Benjamin Kelsey** (Deputy Director, Air Force Research and Development) who commented that a major problem was the existence of longer runways for the modern fighter and how these were vulnerable and might be destroyed through a single crippling enemy strike.

Hence the need for VTOL operations. The article included above is of the utmost importance: in the mid-1950s at the same time that both the US Air Force and CIA were attempting to play down the significance of flying saucer and UFO reports there is substantial evidence to suggest that design teams were building and testing flying saucer prototypes.

Although it has proved difficult to find out about the reality or otherwise of a separate saucer-testing facility situated at Papoose Lake within [Area 51](#) **Bill Rose** has been given information that this was the HQ for much saucer prototype testing and that several accidents and crashes resulted from use of early radial-flow engines.

More recently the unusual story of archeologist and historian **Jerry Freeman** emerged in a series of articles published in the well-known Las Vegas Sun newspaper. Simply stated, Freeman wanted to find evidence of a 19th Century pioneer wagon train known as the lost '49ers. Unfortunately for him, and for history, their remains lay within the boundaries of Area 51! Undeterred, Freeman decided to go on an expedition into the twilight zone and after several days reached Papoose Dry Lake.

He saw a security vehicle in the exact same place that the claimed S4 facilities were hidden and also thought that he saw some sort of door opening in the rock face. It is possible, that electrogravitic systems have been tested both at the Papoose and Groom Lake facilities.

It might be sensible, at this stage, to note the existence of several texts on the question of future propulsion systems for flying discs written in the 1950s. One of these, entitled *Electrogravitics Systems* mentions a research project called *Project Winterhaven* undertaken in 1952 in order to validate Thomas Townsend Browns' *Biefeld-Brown effect*. The report in question makes for fascinating reading and states that:

Using a number of assumptions as to the nature of gravity, the report postulated a saucer as the basis of a possible interceptor with Mach 3 capability. Creation of a local gravitational system would confer upon the fighter the sharp-edged

changes of motion typical in space.

And that:

Glenn Martin say gravity control could be achieved in six years, but they add that it would entail a Manhattan District type effort to bring it about.

The reader will perhaps not be surprised to learn that once again this report was kept away from public view for some 35 years by Air Force Aeronautical Laboratories at Wright Patterson AFB! It was declassified and made available through the Technical Library in the early 1990s.

Whatever the final truth of the matter, we have done enough to establish that flying saucers grew from separate and distinct German-American projects begun in World War Two.

Relatively primitive German discs must have been developed partly because of the failure of the Luftwaffe to defend Axis airfields from allied bombing and the resulting need for VTOL operation. The V173 that became the XF5U1 and later a jet-powered flying pancake was born out of a US Navy requirement for an STOL aircraft.

So why the secrecy?

A number of simple answers emerge: firstly the radial-flow engine is still advanced today. It allows for supersonic flight and tremendous VTOL performance. A revolutionary propulsion technology, electrostatics, might threaten the economic status quo. A circular wing offers good stealth capability and effective handling at low speeds. According to the [Silver Bug documentation](#), radial-flow allows for an aircraft to perform a range of staggering maneuvers including flying edge-on - a characteristic noted in numerous flying saucer/UFO sightings.

It would seem that even if the most straightforward flying saucer stories are to be believed then these aircraft have been used primarily as high-performance reconnaissance vehicles.

The psychological effects of seeing a flying saucer could only be heightened if it was unknown to the observer - an aircraft that did not appear in anything more than pulp fiction tracts about terrifying close encounters with aliens and which was regarded pretty much as a product of science fiction not science fact. Never forget the **CIA** memorandum circulated in 1952 by Director **Walter B. Smith** which noted the possible use of flying saucers for the purposes of psychological warfare.

There is also the whole, and unresolved, political question of the mass transportation of nazi scientists and their families, some with dubious wartime records, to the USA under [the secret Paperclip program](#). Although the existence of Paperclip was known in the early postwar period the actual shocking details of the deals between victor and vanquished led to great concern particularly by those who survived the horrors of concentration camps and/or forced labour under German occupation. Although Paperclip may have resulted in technological achievements the moral position is certainly open to question.

It would seem that the Soviets may have had their saucers too and undoubtedly more is to emerge from the archives there. As a result the US would undoubtedly have been concerned to build the similar and competing aircraft that was *Silver Bug*. Once again, such Soviet work would have been based upon recovered German, not alien, technologies and there has been some suggestion that the Soviets did indeed develop flying saucers. Jan Aldrich's Project 1947 has sought to collate information about early flying saucers sightings and media reports.

One of these reports may have originated via *Project Wringer*, a postwar effort tasked with interviewing military, industrial and other personnel of former Axis countries, Prisoners of War held in the Soviet Union and other Eastern Bloc nations or displaced persons with intelligence or military information. Jan Aldrich found the following report whilst undertaking research at [the US National Archives](#):

**10. SOURCE: EP 134892, Rpt. No. 5418-47758**

dated 19th January 1954. Date of Observation: May 1953.

Preamble: During his internment in PW camp #1 in STALINGRAD (48/42N 44/30E) SOURCE ?????? some ????? of general interest and ??? allegedly observed a couple of flying saucers. SOURCE was always interned in the camp. He understood a little Russian.

Flying saucers: SOURCE emphasized that he had never seen or heard anything of flying saucers before he observed two of them on a dusty morning over Stalingrad in May 1953 when he was on guard within the camp. He observed them in a rather high altitude flying fast in one direction, one following the other. Thinking they had something to do with scientific research of Russia he forgot about his observation until he came back home in Oct.1953 and saw designs of flying saucers in West European magazines. He could not provide further details.

It is difficult to know what to make of such reports except to point out that they were taken seriously by operatives within the intelligence community. In fact, all the evidence we have - some of which is included in my forthcoming book entitled *UFO Revelation* - is that in the early 1950s there was a reorientation of thinking relating to flying saucer sightings whereby the CIA, particularly, chose to concentrate upon attacking the veracity of flying saucer reports by doubting the credibility of the witness. At the same time, the Agency knew, as Haines admits, that saucer prototypes were under construction.

Study of the many CIA documents made available through FOIA requests indicates that the CIA was misleading the public. The Agency often directed requests for information on flying saucer sightings to the Air Technical Intelligence Centre (ATIC) at Wright-Patterson Air Force Base.

Whilst both the Agency and ATIC were claiming that they were unable to determine the origin of flying saucers ATIC/WADC were working upon Silver Bug - and maybe more besides. In addition to this, [Project Grudge had recently been downgraded \(March 1952\) and redesignated Blue Book](#) and this was headquartered at Wright-Patterson Air Force Base!! In any case Blue Book investigators were unable to explain away some 701 of 12,918 sightings they investigated. [Project Blue Book](#) was downgraded through the 1950s to the stage where there was only a handful of personnel working on UFO sightings.

In fact, according to **David Jacobs**, the downgrading took place after September 1953 and went hand in hand with Air Force regulation 200-2 which stated that local Air Force base commanders could only discuss sightings if they had been solved and that any others should be classified. Jacobs also notes that February 1955 (Silver Bug was released from ATIC-WADC on the 15th February) was of significance because ATIC sought to explain away as many sightings as possible and to leave no unsolved cases.

*Project Blue Book Special Report Number 14*, dated May 5th, 1955 and release in October determined that:

On the basis of this study we believe that no objects such as those popularly described as flying saucers have overflown the United States.

We now know that this was a lie:

CIA officials knew that the British and Canadians were already experimenting with flying saucers. Project Y was a Canadian-British-US developmental operation to produce a non-conventional flying-saucer-type aircraft, and Agency official feared that the Soviets were testing similar devices.

The downgrading and the debunking of UFO reports was deliberate and took place at exactly the same time that the US was working upon advanced flying saucers. Once this is understood and established the official attitudes towards flying saucer sightings make more sense. Secrecy, and perhaps even paranoia, appear to have gripped the intelligence community and the USAF. Even now, some forty five years after Silver Bug was test-flown former project workers remain tight-lipped. We can only conclude that silence in this case indicates particularly advanced technologies and the need to keep a lid on the details relating to them.

One could easily make a case that the development and debunking of flying saucers was undertaken at Wright-Patterson Air Force Base and it is to be hoped that this document will encourage people with information about US saucer projects to come forward. It is up to UFO researchers to reorient their thinking, to come to terms with man-made flying saucer reality and the ongoing cover-up relating to it.

The case for **man-made UFOs** is stronger than ever whereas the evidence for alien flying saucers is wholly untenable. We have introduced here a new line of research and a new perspective on UFO reality. Beyond the fantastic claims and mystification of UFOs by too many UFO researchers the painful truth is that flying saucers were, and are, a tremendous human technical achievement. The truth is that serious research exists only beyond the unfortunate skeptic-believer dialectic.

Surely it is to the military-industrial complex and not the heavens above that we should look for the origins of the flying saucer.



The Ho IX V-2 taxiing for take off



The Ho IX V-2 in flight, February 1945

## More On Flying Wings And Saucer-Shaped Craft

### Known Disc-Shaped, Triangular, Flying-Wing Aircraft

by **Charles McGrew**

c.1992 by Charles McGrew

We all know about B-2's and F-117's, and could see how they might be described as "disk-shaped" if viewed from the appropriate angle. Here's some other information about some similar aircraft from the past. They are presented here merely to show that disk-shaped flying craft are not only possible, but have been built.

**XB-35** - In response to the possibility of Britain falling in the early stages of WWII, the US Army Air Force began taking designs for extremely long-ranged, heavy-bomb-load aircraft that could fly from North America to Germany and back, carrying 10,000 pounds of bombs. Northrop proposed the XB-35. The XB-35 had 4 engines, each driving two counter-rotating pusher propellers along the same shaft (!). Pictures of the XB-35 look like each shaft has a six-bladed propeller, but its actually two three-bladed propellers -- for a total of 8 propellers.

**Jack Northrop** had been experimenting with flying-wing designs since the early 1920's. In Germany, the Horton brothers (see below) were working on a flying wing as well -- the final designs look surprisingly like the XB-35 (though it had only two propellers).

Northrop's first prototype was the N-1M (nicknamed "the Jeep"), which was tested in the Roseman Dry Lake in the Mohave Desert from July 1940-early 1942. It had two pusher propellers, and space for one pilot. Wingspan was 38 feet, and the plane weighed 4,000 pounds. First "public" flight made the newsreels. The wings were altered significantly as testing went on; for instance the "drooping wingtips" were discarded early on. The (only) N-1M stills exists, and has been restored, it is now sitting in a Smithsonian storage hangar, painted its original brilliant yellow.

Northrop was contracted by the US Army Air Force Materiel Division to build one XB-35 (wingspan 172'). The N-9M was the first product from the contract, a 1/3 scale (working, though wood-structured, not metal) model with two engines with a 60' wingspan as a test-bed/trainer. It first flew successfully on Dec. 27, 1942. Three other N-9M's were built, and the N-9M test program was completed in Oct. 1944. [The last surviving N-9M is being painstakingly rebuilt by the "Planes of Fame" Museum, in Chino, CA] One of the N-9M's crashed during testing.

On June 25th 1946, the XB-35 was at last ready to fly (after a number of difficulties with the propellers) at Hawthorne Field, CA -- the Northrop company field. The '35 was now in competition with what became the Consolidated B-36 as the postwar strategic bomber (interestingly, both planes were pushers.) Its first flight was from Hawthorne to Muroc Dry Lake (later named Edwards AFB) for additional testing.

Attempts to make the propeller system less complex were generally unsuccessful. Northrop decided to replace the props with 8 jet engines, and continue work on the plane, renamed the YB-49. Only 2 XB-35's were ever completed, the second one first flying on June 26, 1947. The Martin Corporation worked on the YB-35 (same basic plane, just built at Martin), and the only YB-35 first flew on May 15, 1948.

**YB-49** - The power problems of the XB-35 completely disappeared with the jet engines, but unfortunately they reduced the range of the plane such that it could not be thought of as a strategic bomber (mid-air refueling not then being feasible).

The second YB-49 produced was the first to fly, flown by Maj. Robert Cardinas, the US Army Air Force test pilot assigned to the Northrop program (i.e. Northrop retained control, but had military test pilots mixed in with their own.) On April 26th 1948, the YB-49 flew 4,000 miles with a 10,000 pound payload, on circuitous route that took it as far east as Phoenix, and as far north as San Francisco.

In June, 1948 a YB-49 on a routine test flight crashed (Capt. Glen Edwards, for whom Edwards AFB is named, died in this crash, along with four others); specific cause of the crash was never determined; structural failure was the most likely reason.

The military had expressed an interest in a reconnaissance version (with two extra jets) of the YB-49, called the YRB-49, and placed an order for 30. In January 1949, though, this order was cancelled.

In Feb. 1949 the remaining YB-49 flew from (now) Edwards AFB to Andrews AFB in record time (just over 4 hours - the record was broken the next day by the XB-47, its medium-bomber competitor, which flew almost 100mph faster). The famous YB-49-over-the-Capitol photos are from this flight. President Truman toured the plane's interior on the ground, and then '49 headed back to Edwards. During the flight, 6 of the 8 engines failed due to an oil failure which has a slightly mysterious history (apparently the oil reservoir had not been filled properly before the flight -- there are hints of

sabotage). The YB-49 made an emergency landing at Winslow AZ. Later on in 1949 the last flying YB-49 was destroyed during high-speed taxi tests, when the undercarriage collapsed.

In November 1949, the Air Force (the US Army Air Force became the US Air Force on July 26, 1947 -- it changed from the US Army Air Corps to the US Army Air Force on June 29, 1941) cancelled the last part of the YB-49 contract, that of converting the remaining partially-completed XB-35's to jet power. The last 11 XB-35 hulls (in varying states of completeness) were rolled out onto the flight ramp outside of the factory, lined up, photographed (a very impressive aerial photograph of them lined up survives) and broken up for scrap. Northrop employees made a last-ditch request to finish the planes in their spare time, which Jack Northrop had to turn down, for fear of jeopardizing further military contracts.

(Political shenanigans for government contracts were just as silly back then as they are now, and Northrop was concerned that Stuart Symington, secretary of the Air Force, would look unkindly on Northrop in general if the planes were not destroyed -- Symington was very specific that the YB-49 program not continue. Northrop partisans say that Symington wanted to force Northrop to merge with Convair, for reasons of his own, and was hoping to damage Northrop enough to force the merger. Others say that the expected costs of the YB-49 were sufficiently higher than the XB-57 to warrant the choice of the latter.)

(Other WWII-flying-wing ideas from Jack Northrop included the turbojet-powered XP-79 "Flying Ram", a rocket-powered interceptor that was designed to literally slice the tail off of enemy aircraft with its heavily-reinforced wing to knock them down. The XP-79 actually flew (once -- it crashed), along with at least one similar prototype, the (rocket powered) MX-324, which first flew (powered) on July 5, 1944. Another was the JB-1, an unmanned rocket-assisted, turbojet-propelled missile, and the XP-56, another pusher-flying-wing; this time a fighter, with two counter-rotating propellers along the same shaft, which also made several test flights, in 1943 and 1944 one of the two XP-56's crashed in a landing, the other wound up at the National Air and Space Museum.)

Jack Northrop resigned from the company he had built after the YB-49 was cancelled, and left the aircraft industry entirely. In the mid-1970's, NASA sent him a letter that they were re-examining the flying wing idea (also, the YB-49's small radar signature was being taken more seriously by then.) In April 1980, he (suffering now from Parkinson's disease) was given a security clearance, taken to Northrop, and shown a model of the B-2. Makes a nice ending to the story, eh? The B-2 has exactly the same wingspan as the YB-49 (172').

(An interesting sidelight: in the late 1940's Northrop had also made a slick promotional-film campaign to drum up support for the flying wing; this included a film describing a proposed 80 passenger flying-wing commercial jet.)

Also, here are some other (lesser-known) planes that appear "disk-shaped" when viewed from one angle or another. (Note that both these aircraft did *\*not\** become operational, for technical reasons.)

The *Horten Brothers' Wings* - in the 1930's and 1940's in Germany, the Horten Brothers, **Walter** and **Reimar**, built a succession of flying wing designs which were quite advanced, and on the cutting edge for their day. Their "Ho" series is as follows:

- Ho I - 1931 - a flying-wing sailplane.
- Ho II - 1934 - initially a glider, it fitted with a pusher propeller in 1935. Looked very like Northrop's flying wings.
- Ho III - 1938 - a metal-frame glider, later fitted with a folding-blade (folded while gliding) propeller for powered flight.
- Ho IV - 1941 - a high-aspect-ratio glider (looking very like a modern sailplane, but without a long tail or nose).
- Ho V - 1937-42 - first Horten plane designed to be powered, built partially from plastics, and powered by two pusher propellers.
- Ho VI "flying parabola" - an extremely-high-aspect-ratio test- only glider. (After the war, the Ho VI was shipped to Northrop for analysis.)
- Ho VII - 1945 - considered the most flyable of the powered Ho series by the Horten Brothers, it was built as a flying-wing trainer. (Only one was built and tested, and 18 more were ordered, but the war ended before more than one additional Ho VII could be even partially completed.



- Ho VIII - 1945 - a 158-foot wingspan, 6-engine plane built as a transport. Never built. However, this design was "reborn" in the 1950's when Reimar Horten built a flying-wing plane for Argentina's Instituto Aerotecnico, which flew on December 9, 1960 -- the project was shelved thereafter due to technical problems.
- Ho IX - 1944 - the first combat-intended Horten design, it was jet powered (Junkers Jumo 004B's), with metal frame and plywood exterior (due to wartime shortages). First flew in January 1945, but never in combat. When the Allies overran the factory, the almost-completed Ho IX V3 (third in the series - this plane was also known as the "Gotha Go 229") was shipped back to the Air and Space Museum.

[Interestingly, the Horten brothers were helped in their bid for German government support when Northrop patents for the N-1M appeared in US Patent Office's "Official Gazette" on May 13, 1941, and then in the International Aeronautical journal "Interavia" on November 18, 1941.]

Of course, one other "Flying-Wing-type" plane existed in the German Luftwaffe - Alexander Lippisch's-inspired Me-163 rocket-powered interceptor, and its intended successor, the Messerschmitt P.1111, a turbojet-powered fighter. At the end of the war, Lippisch was engaged in supersonic-fighter research, models of his "P12" were shipped back to the US for analysis.

- The "Zimmer Skimmer" (aka "The Flying Pancake") - in an attempt to develop a high-speed interceptor (fast enough to overtake diving enemy planes) to deal with Japanese kamikaze attacks, the Navy asked for bids for such an aircraft in early 1944. (The Chance-Vought F4U Corsair - and the Grumann F4F and F6F - eventually filled this bill more or less, but were hard to land on carriers, for weight and pilot-visibility reasons). Minimum speed desired was 450mph, then-available planes would do only about 400mph.

Charles Zimmerman, a research engineer for NACA, had come up with a disk-shaped, two-propeller aircraft idea before the war, which promised to be fast, and have short-take-off-and-landing ability (which included the ability to hover), which would be useful on aircraft carriers. (Imagine an oblong disk, with a canopy on top near the front, twin rudders and two small aerolons in the rear, and twin booms extending forward from the left and right sides of the disk with a huge counter-rotating propeller on each. The undercarriage was a spindly-looking tricycle arrangement that had the "Skimmer" taxiing at about a 40 degree angle. The fuselage was the "wing", but was much thinner and wider than later "lifting body" experiments. Hovering was accomplished by going nose-vertical and, well, just hanging there - such was the power of the propellers. Wingspan approximately 30-40 feet [by my eye].)

- The V173 (the first prototype version) was built by Chance-Vought. Boon T. Guiten was its first test pilot. Its first flight (November 23, 1942) lasted only 13 minutes, but was entirely successful, and testing continued. One of the later-on test pilots was Charles Lindberg, who was an enthusiastic supporter. In July 1944, the Navy ordered two more "Skimmers" built for further testing, each equipped with significantly more powerful engines (1350hp Pratt and Whitneys -- the V173 was judged underpowered, since its top speed was not up-to-spec). The two new planes were built from "metalite", a composite material made from sandwiching layers of aluminum and balsa wood. These planes were designated F5U's.
- The F5U's were actually overpowered, and had a clutched gearing system to vary propeller speed in flight. In addition, a geared propeller-synchronizer was also installed. The first F5U was ready for flight in August, 1945 (but was delayed by a lengthy redesign of the propellers). By 1948, an F5U was finally ready to fly, but technology had passed the plane by (jets were already doing 600mph). The F5U taxi'd up and down the runway a couple of times, but never flew. Total pricetag on the project was about \$9M. Both F5U's were scrapped. (The F5U's were intended to be sent to Edwards AFB for testing -- shipped via the Panama Canal; apparently the skimmer's unusual shape would have made ground transport difficult.) [In the mid-1930's the Arup S1, S2, S3 and S4 - looking very like what became the Zimmer Skimmer, but with a single centerline "puller" propeller - were flown as flying billboards and test aircraft.]
- The Avro (Canada) "Avrocar" was an outright flying saucer. It used three Continental turbojets, turning a central impeller ("turbo rotor") to keep it airborne with downward thrust, with a vane/shutter system to propel the craft in pretty much any direction by venting thrust in any direction desired. It was built to hold two human crewmen in separate cockpits on either side, facing front - total width of the Avrocar was 18 feet, with tricycle landing pads or wheels for undercarriage. It was first proposed in the early 1950's by the Avro company to the Canadian government.

The maximum expected airspeed was originally about 700mph. As Avro worked on the design, expected airspeed dropped to 300mph. By the mid-50's, a very-secret project (unknown to even most Avro employees) was in full swing to build the Avrocar. The blades of the Avrocar turbo-rotor were hollow with internal reinforcing, and brazed to cement the parts. The first turbo-rotor was tested for 150 hours without mishap.

By 1955, the costs of the project had escalated beyond the resources of the Canadian government. The project after that was underwritten by the US DoD (the USAF and Army were both interested.) The Avrocar first flew with a pilot on Dec. 5, 1959 (prior to that, it was tested unmanned). Two were built - one Avrocar was tested out at the Ames research center in California, the other remained with Avro for testing. Although the aircraft did fly, its ability to rise and top speed was extremely disappointing, mostly due to thrust dissipation in the impeller. The Avrocar was able to clear (small) obstacles without difficulty, but maximum altitude was never more than about 6 feet! The project was quietly closed down.

Both **Avrocars** are still intact, and survive in US museums (not sure which, though).

... curiously, the Avrocar's technology was within a hair's breadth of being successful. Using almost exactly the same propulsion setup, the British developed hovercraft (the first being the British SRN-1) in the early 1960's -- basically an Avrocar propulsion system with a rubber skirt, which greatly improved the use of downward thrust.

... in recent years, a one-person "homebrew" version of an Avrocar has appeared (alas, I cannot remember the fellow who built it's name, but he has built a lot of neat flying vehicles, and I've seen film of the avrocar-like vehicle flying).

**Edmund Doak** also was contracted by the USAF to develop disk-shaped airfoil aircraft in the 1950's and 1960's. His last and most promising, the Doak-16, was canceled by the USAF.

[Sources: Documentary "The Wing Will Fly", a 'Wings' documentary on "Strange Planes", and "Winged Wonders", by E.T. Wooldridge, published by the National Air and Space Museum, 1983, "In Search Of" episode "UFO Coverups".]

[http://www.bibliotecapleyades.net/ufo\\_aleman/esp\\_ufoaleman\\_10.htm](http://www.bibliotecapleyades.net/ufo_aleman/esp_ufoaleman_10.htm)

## Photo Report of information found in declassified files



Above images: drawings from a flying object that it is thought the VRIL Society assembly for traveling to "the other side"



Above image: small flying system constructed in 1922 by the VRIL Society



Junkers patent, dated 1910, of a strange flying machine



A sketch of the RFZ 2



Images of the RFZ prototypes



RFZ 2 test flight



In spite of difficulties and deficiencies found in the construction of the RFZ 2, this one was developed for a new model designated as VRIL-1

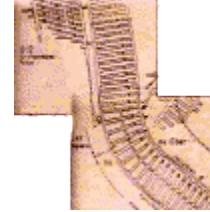

Undergrounds constructions: they were built to manufacture "strange" flying machines (VRIL), having been used years later to build V-1 and V-2 bombs

Drawing: the great tunnels and galleries are well notorious as it can be seen in this image

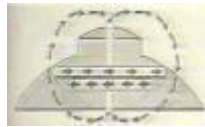
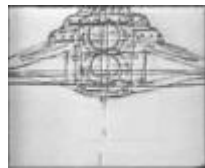

There were several projects found by the Allies in the SS files, when they occupied Berlin in 1945



HAUNEBU II

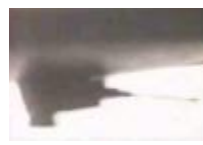
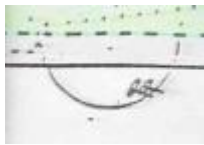

At the beginning, the German technicians thought to apply conventional "weaponry" in these "flying machines", installing "Panzer" tank cannons.



The evolution of the VRIL and the HAUNEBU was extremely fast thanks to the OVNI pieces recovered at the Black Forest and in Gdynia



The SCHWAABENLAND ship

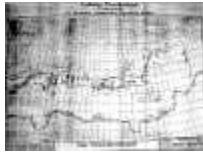

This map, cannot be exhibited in Germany ...under prison penalty. Later on, the ban was lifted by the German Parliament

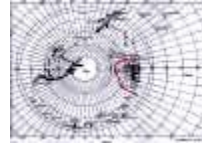

Territory occupied by Germany on 1938 in Antarctica. Was given the name of NEU-SCHABENLAND



The arrival of the nazis to Antarctica and the "demarcation" of the occupied territory (600.000 Km2), through drop-flags thrown by hydroplanes



U-Boat submarine in Azores



U-Boat submarines in Antarctica 1943

Some images of VRIL 7 and VRIL 6



Details of bottom area: VRIL 7



Detail of bottom area:  
RFZ 5



Part of a project:  
HAUNEBU III



Part of ANDROMEDA project :  
"flying cigar" transporter of  
different kind of objects



Arado Ar 65  
(Year: DEC 1941 Speed.: 900 Km/h;  
Altitude: 12.000 m; Motors: Heinkel He 109)



Focke-Wulf Vorschlag 1  
(Year: DEC 1942 Speed: 930 Km/h;  
Altitude: 13.600 m; Motors: BMW P 3302)



Henschel HS P 75  
(Year: 1941 Speed.: 790 Km/h; Altitude: 12.000 m; Motors:  
Daimler Benz DB 613 A/B)

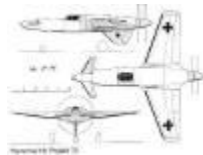

Henschel HS P 135  
(Year: FEB 1945 Speed: 984 Km/h;  
Altitude: 14.000 m; Motors: Heinkel He S 011)



Blohm Voss BV P208/3  
(Year: NOV 1944 Speed: 790 Km/h;  
Altitude: 11.400 m; Motors: Daimler Benz DB 603)

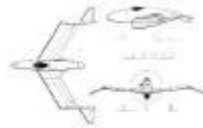

Junkers Ju EF 128  
(Year: FEB 1945 Speed.: 990 Km/h;  
Altitude: 13.700 m; Motors: Heinkel He S 011)



Gotha Go P60 C  
(Year: FEB 1945 Speed: 930 Km/h; Altitude: 13.300 m;  
Motors: Heinkel He S 011)



Horten HIX  
(Year: MAR 1945 Speed: 950 Km/h; Altitude: 16.000 m; Motors: Junkers Jumo 004 B-2)



Gotha P 60  
(Year: JAN 1945 Speed: 915 Km/h; Altitude: 12.500 m; Motors: BMW 003 )

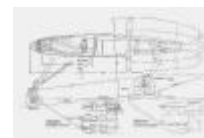



Horten XIIIb  
( Year: 1944 Speed: 1200 Km/h; Altitude: 15.000 m; Motors:  
Heinkel He S 011 A-0 )

[http://www.bibliotecapleyades.net/tierra\\_hueca/esp\\_tierra\\_hueca\\_3a.htm](http://www.bibliotecapleyades.net/tierra_hueca/esp_tierra_hueca_3a.htm)

## Secret Flying Discs of the Third Reich

(1922-1945)  
from [LaesieWorks](#) website

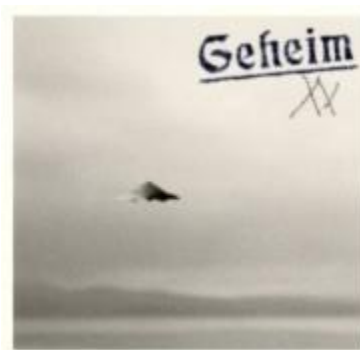

Although this page contains lots of photos, most could be fake. If they are fake, people have put a lot of effort in faking them. If one is real (like a **Haunebu** or **Vril**)... it is kept secret, and most interesting to me would be the propulsion system.

### German Saucers index:



Haunebu



Flügelrad



RFZ



Vril



JFM

[http://www.bibliotecapleyades.net/ufo\\_aleman/esp\\_ufoaleman\\_2.htm#Secret Flying Discs](http://www.bibliotecapleyades.net/ufo_aleman/esp_ufoaleman_2.htm#Secret Flying Discs)

# HAUNEBU

# U

Haunebu Series: I, II, II-  
DoStra, III

*Using the "Thule - Triebwerk"*

Hauneb  
u||

HAUNEBU I

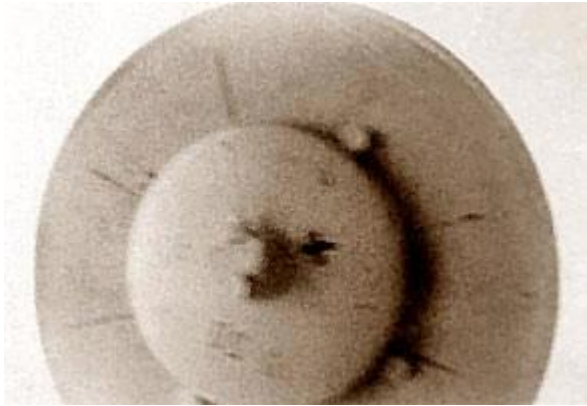
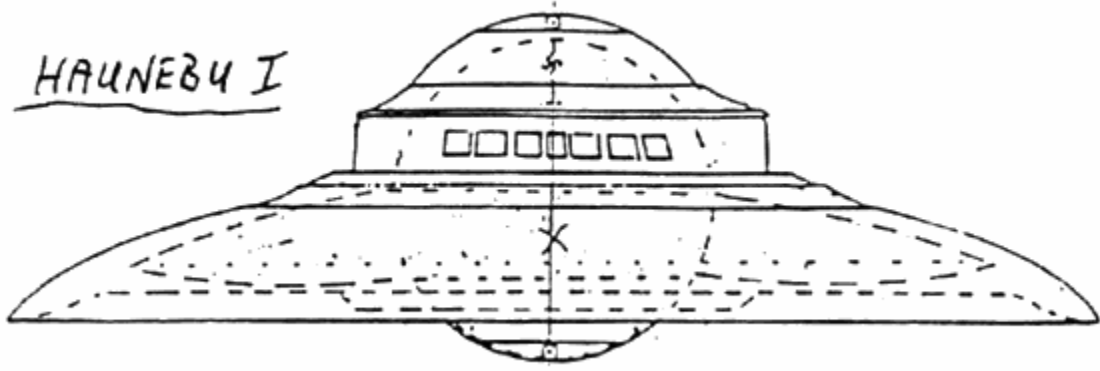

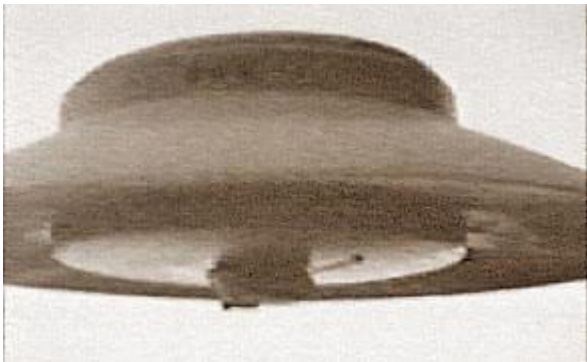
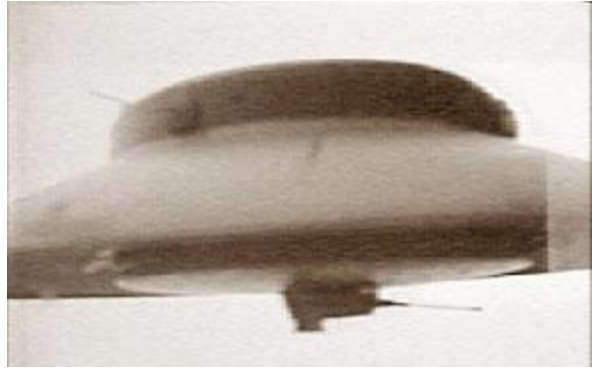

Donar Kraftstrahlkanone



# Haunebu II, II- DoStra

(Do-Stra = DOrnier-STRAtosphärenflugzeug)

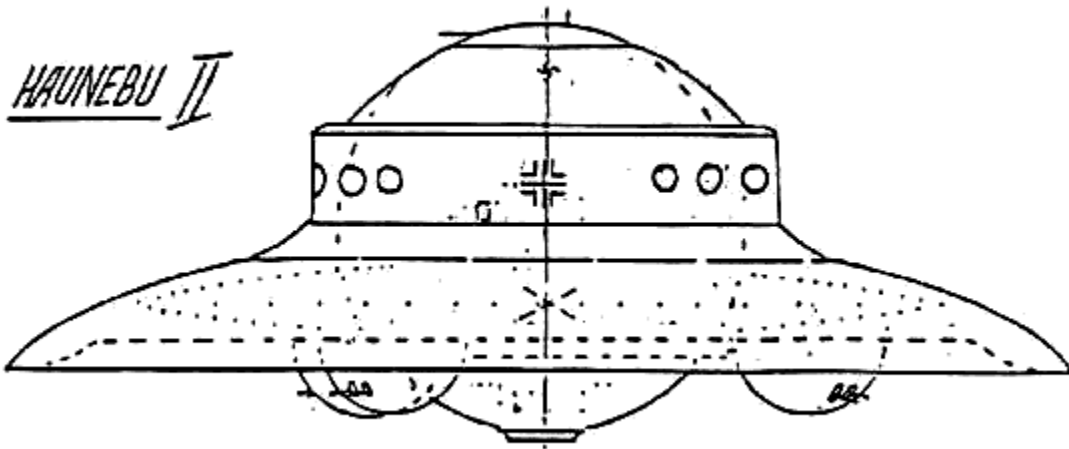





Beschriftung auf dem Foto entfernt.

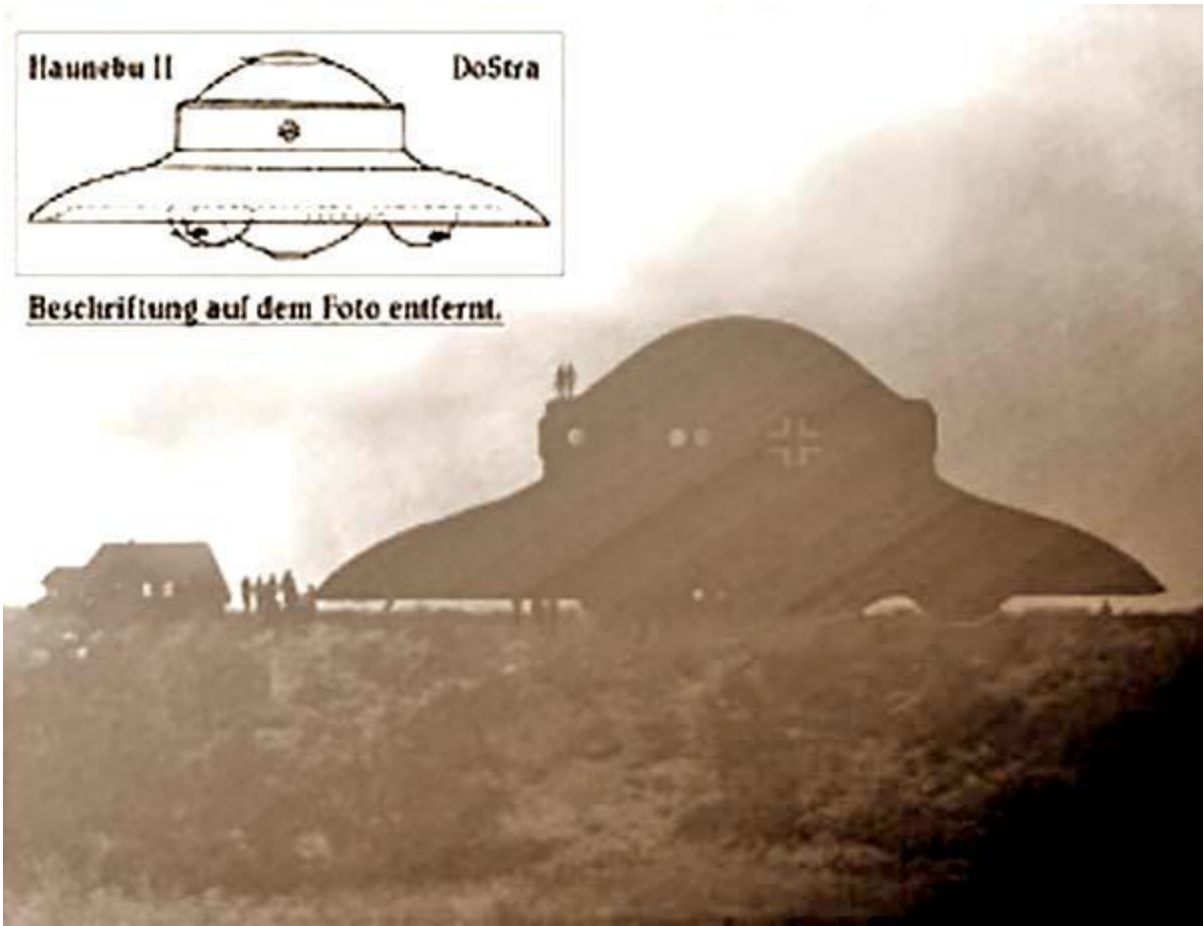

Haunebu  
|||

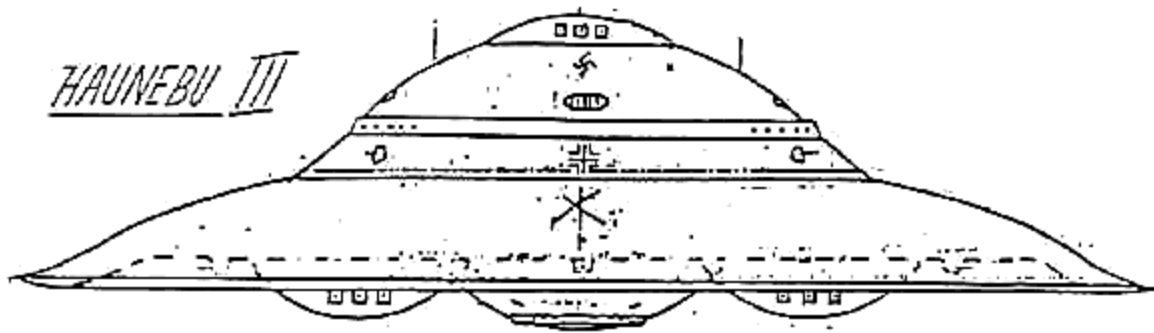

Haunebu  
IV



The Haunebu's celestial  
navigation unit KT-P2  
("click" to enlarge)

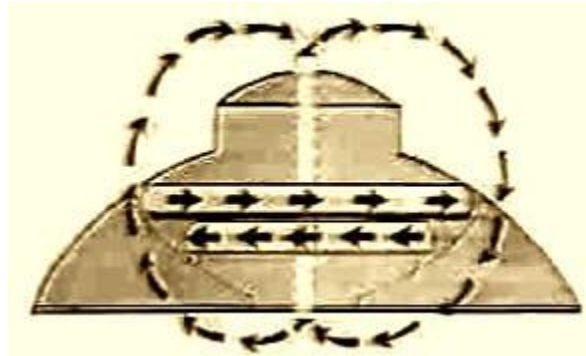
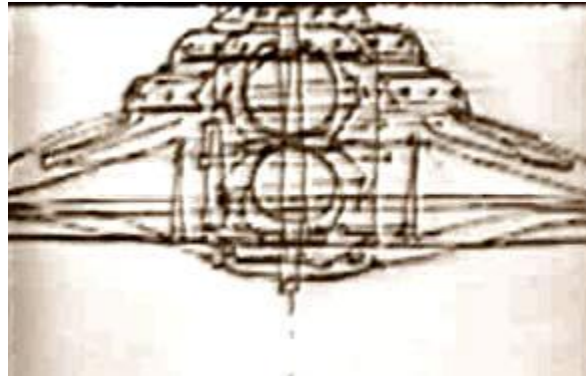

# NAZI UFOs TRUTH or MYTH?

## The HAUNEBU DISC

from [EyePod](#) Website

### Early Development

The **SS E-IV** (Entwicklungsstelle 4), a development unit of the SS occult "Order of the Black Sun" was tasked with researching alternative energies to make the Third Reich independent of scarce fuel oil for war production. Their work included developing alternative energies and fuels.

This group developed by 1939 a revolutionary electro-magnetic-gravitic engine which improved **Hans Coler's** free energy machine into an energy Konverter coupled to a Van De Graaf band generator and Marconi vortex dynamo (a spherical tank of mercury) to create powerful rotating electromagnetic fields that affected gravity and reduced mass.

It was designated the **Thule Triebwerk** (Thrustwork, a.k.a. Tachyonator-7 drive) and was to be installed into a Thule designed disc.



Since 1935 the Thule Gesellschaft (Society) had been scouting for a remote, inconspicuous, underdeveloped testing ground for such a craft. Thule found a location in Northwest Germany that was known as (or possibly designated as) Hauneburg. At the establishment of this testing ground and facilities the SS E-IV unit simply referred to the new Thule disc as a war product- the "H-Gerat" (Hauneburg Device).

For wartime security reasons the name was shortened to **Haunebu** in 1939 and was briefly designated RFZ-5 along with Vril's machines once the Hauneburg site was abandoned in favor of the more suitable Vril Arado Brandenburg aircraft testing grounds.

The early **Haunebu I** craft of which two prototypes were constructed were 25 meters in diameter, had a crew of eight and could achieve the incredible initial velocity of 4,800 km/h, but at low altitude. Further enhancement enabled the machine to reach 17,000 km/h.

Flight endurance was 18 hours. To resist the incredible temperatures of these velocities a special armor called Victalen { Frozen Smoke } was pioneered by SS metallurgists specifically for both the Haunebu and Vril series of disc craft. The Haunebu I had a double hull of Victalen. {Frozen Smoke developed in the 30's}

### The Experimental KSK Gun

The early models also attempted to test out a rather large experimental gun installation- the twin 60 mm KSK (KraftStrahlKanone, Strong Ray Cannon) which operated off the Triebwerk for power. It has been suggested that the ray from this weapon made it a *laser*, but it was not. The Germans called it an "anachronism" gun - *not belonging to that time period or out of place*.

When a **Vril 7** was downed by the Russians in 1945 a similar underbelly mounted KSK gun was destroyed with debris

recovered from the battle site. Postwar the strange metal balls and tungsten spirals that made up the weapon could not be identified. But recently it has been speculated that the Triebwerk-connected balls formed cascade oscillators that were connected to a long barrel-shrouded transmission rod wrapped in a precision tungsten spiral, or coil to transmit a powerful energy burst suitable to pierce up to 4 in (100 mm) of enemy armor. The heavy gun installation, however, badly destabilized the disc and in subsequent Haunebu models lighter MG and MK cannon were supposedly installed.

## The Series Prototypes

The **Haunebu I** first flew in 1939 and both prototypes made 52 test flights. In 1942, the enlarged **Haunebu II** of 26 meters diameter was ready for flight testing. This disc had a crew of nine and could also achieve supersonic flight of 6,000 to 21,000 km/h with a flight endurance of 55 hours. Both it and the further developed 32 meter diameter Haunebu II Do-Stra had heat shielding of two hulls of Victalen. The craft were constructed and tested between 1943-44. The craft made 106 test flights.

By 1944, the perfected war model, the **Haunebu II Do-Stra** (Dornier STRAtosphären Flugzeug/Stratospheric Aircraft) was tested. Two prototypes were built. These massive machines, several stories tall, were crewed by 20 men. They were also capable of hypersonic speed beyond 21,000 km/h. The SS had intended to produce the machines with tenders for both Junkers and Dornier but in late 1944/early 1945 Dornier was chosen. The close of the war, however, prevented Dornier from building any production models. Yet larger still was the 71 meter diameter **Haunebu III**. A lone prototype was constructed before the close of the war. It was crewed by 32 and could achieve speeds of 7,000 to 40,000 km/h. It had a triple Victalen hull. It is said to have had a flight endurance of 7 to 8 weeks. The craft made 19 test flights. This craft was to be used for evacuation work for **Thule** and **Vril** in March 1945.

Further plans for a 120 meter diameter **Haunebu IV** were in the works but no such craft is known to have been constructed before the end of the war.

## Flügelrad d

Flügelrad Series: I V-1 and V-2, II V-1, V-2, and V-3, III



Possible constructed BMW Flügelrad II V-2 in flight, April 1945  
Powered by underbody BMW 003 turbojets

## Flugelrad I V-2

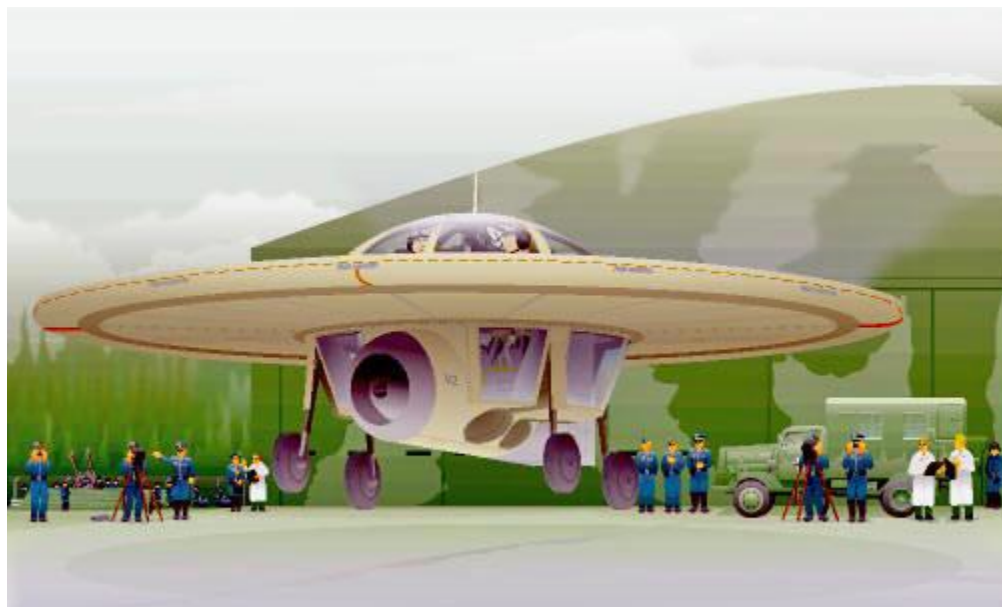

Drawing by Richard Lewis Mendes

## BMW Flugelrad Chronology

by Rob Arndt

### 1943

**BMW Flugelrad I V-1** was painted matte aluminium and performed its first flying test at the **Czech Aerodrome at Prag-Kbely** between August and September. It left the hanger by its own means, the rotor began to spin and the machine lifted to 1 meter and flew for 300 meters before making a hard landing. During static tests the prototype was surrounded by concrete blocks to protect the crew in the event of a disc blade breaking. In appearance the basic **Flugelrad** lay-out was of a central body housing a pilot covered by a hemispheric dome surrounded by a disc blade rotor of 6 meters with a lower body housing a BMW 003 jet engine, fuel, a **Strahlrohr** jet deflector and fixed landing gear of 4 legs fitted with wheels (with no brakes nor shock absorbers). Flight was achieved by jet exhaust deflection into the 16 variable-pitch disc blades with hydropneumatic actuators.

### 1944

Several changes were introduced on the second prototype designated **BMW Flugelrad I V-2**. The cockpit was enlarged to carry two crew and serve as support for the addition of an aerodynamic rudder. The fixed landing gear was replaced with a more practical semi-retractable one. Rotor diameter was enlarged to 8 meters but kept the 16 disc blades. The machine was painted yellow and performed its first flight tests in the autumn of 1944 at the **Neubiberg Aerodrome** near BMW's Munich facility. Stability problems continued to plague the machine.

### 1945

The next prototype, **BMW Flugelrad II V-1**, kept the same body but discarded the failed rudder, which proved almost useless. The rotor was enlarged to 12.6 meters. The first flight was at **Prag-Kbely** in February 1945 with another jump at low altitude. Three other **Flugelrad** models were under study in early 1945:

- the BMW Flugelrad II V-2 under construction
- the BMW Flugelrad II V-3 models
- the BMW Flugelrad III design phase

Both the **BMW Flugelrads II V-2** and **V-3** would have used two BMW 003 engines in the lower body side-by-side, enlarged cockpits for four crew, and rotor enlargement to 14.4 meters (although the V-2 would have had 24 disc blades while the V-3 would have had 21). The final **BMW Flugelrad III** would have been the production aircraft- a huge stratospheric recon aircraft powered by two BMW 018 engines each with twin Strahlrohre mounted one above the other,

an upper and lower cockpit arrangement, 6 crew, enlarged 24 meter rotor with 32 disc blades, fully retractable gear, and room for an array of recon cameras. Nevertheless, all work ceased on the **Flugelrads** in April 1945. All prototypes and documentation were destroyed in the Russian advance.

## **RFZ (RundFlugZeug discs) of the Thule/Vril type**

(1934-  
1945)

**RFZ Series:  
1,2,3,4,6.**

**RF  
Z-1  
(1934)**

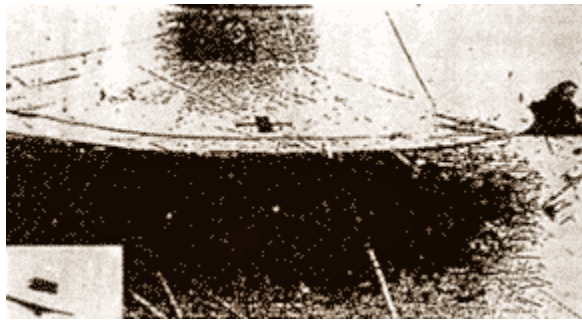

**RF  
Z-2  
(1934)**





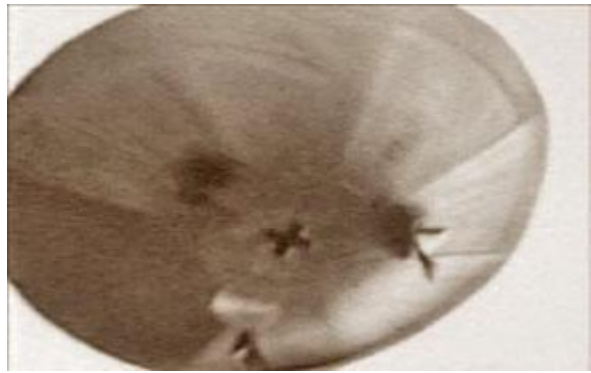
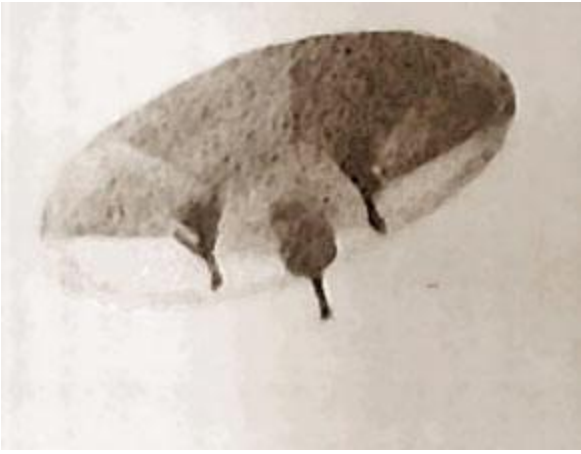

**RF**  
**Z-3**  
(1934)



**RF**  
**Z-4**  
(1935)



**RF**  
**Z-5**

RFZ 5 was changed to Haunebu I (1939)

**RF**  
**Z-6**



[Return](#)

**Vr**  
**il**

**Vril Series: 1,7, 8 Odin, Vril 2 and 9 are designs**

**Vr**  
**il**  
**1**  
**(1942)**



Vril 1

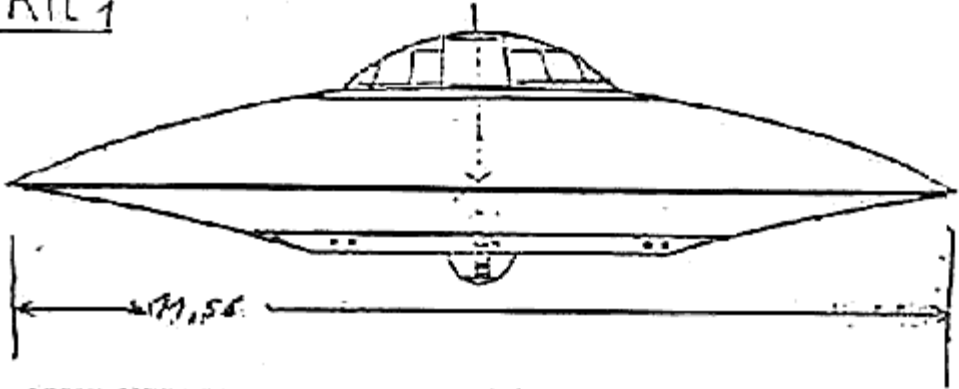

LEICHTE BEWAFFNETE FLUGSCHREIBE (JÄGER), TYPE „VRIL“  
(~~Sammel~~-Gruppe)

Durchmesser: 11,50 Meter  
Antrieb: Schweben-Levitator (gepatentiert)  
Steuerung: Mag-Feld-Impulsor 3a  
Geschwindigkeit: 2900 Kilometer p. Stunde (bisher), bis zu ca. 12000 mögl.  
Reichweite (in Flughöhe): 5 1/2 Stunden ((Flug-entladung mittels K2 von  
Hansen aus, wird erprobt))  
Bewaffnung: 1 Sch LSK, fernsteuerbar, unten, + 2 x MG 108 u. 2 x MG 17  
Aufspannung: Doppel-Y-Kabel  
Besatzung: (je nach Fliehbereich) 1 bis 3 Mann  
Weltallfähigkeit: 100 %  
Stillenschwebefähigkeit: 12 Minuten  
Allgemeine Flugfähigkeit: Wetterunabhängig Tag und Nacht  
Grundsätzliche Einsatzzeit: ca. Sept. 1944, Dr. Schubert.

## Vril 1 "Jager (Hunter)"

(1941)

The Vril motto "Not all good comes from above" summarizes the entire history of the Vril Gesellschaft (Society) from its inception to the final days of WW2 when this occult group seemed to vanish right off the face of the earth.

The name Vril is the shortening of "VRI-IL" which means "Like God". Officially Vril was "The All German Society for Metaphysics" which merged with the Thule Gesellschaft and the obscure DHvSS (*Men of the Black Stone*) in the year 1919.

Each occult group had its own distinct beliefs and origins. The DHvSS (1912) worshipped the German mountain goddess Isias and the Schwarz Stein (black stone). The Thule Gesellschaft (1917) believed in the [hollow earth theory](#) and derived its name from Ultima Thule the ancient capital of Hyperborea at the top of the world. Vril worshipped the Black Sun (the invisible inner light of the Godhead) which supposedly gave or generated incredible power and communicated with Aryan aliens through psychic channeling.

But unlike the other two groups the Vril Gesellschaft were an inner circle of women who were also fighting against their times and culture. They were psychic mediums that wore a horse-tail hairstyle. They believed that their long hair acted as cosmic antennae to receive alien communication from beyond. So this is where the Vril disc story begins.

Despite their distrust of men, the women of Vril joined with the Thule Gesellschaft and DHvSS in order to construct an inter-dimensional channeled flight disc known as the JenseitsFlugMaschine (JFM).

By 1922 the odd disc shaped machine was constructed in Munich and tested for two years. It is not known if any success with channeled flight was ever achieved but a certain W.O. Schumann of the *Technical University of Munich* invented a levitator from the channeled JFM information provided

by the mediums Maria Orsic and Sigrun. By 1924 the JFM project was scrapped but work continued on perfecting the levitator unit known by then as the Schumann SM-Levigator.

With the Nazi Party in power in 1933 (which itself originated from the Thule Gesellschaft) the occultists now received official backing for their continued development of the flight discs. Thule and Vril started with the RFZ (Rundflugzeug, or Round Aircraft) series from 1934-41.

As war had started in 1939 the RFZ-5 became the Haunebu I and by 1941 the RFZ-7 had become the Vril 1 Jager (Hunter). The reason for the changes were due to Thule's revolutionary Triebwerk (Thrustwork) engine that used rotating electro-magnetic-gravitic fields to affect gravity. Vril had by 1941 perfected the SM-Levigator as well and thus two new series entered limited construction, but with slightly different goals.

Thule wanted to develop both a production combat craft and a functional Raumschiff (Spaceship). Vril, by comparison, only wanted to develop Raumschiffen to reach Aldebaran in the Taurus Constellation 68 light years from earth.

As Hitler had forbid secret societies in Germany from 1941 forward, both Thule and Vril were documented under the SS Technical Branch Unit E-IV (Entwicklungsstelle 4) tasked with developing alternative energies. This unit had already helped with the RFZ series but now "officially" Thule and Vril did not exist. Vril became known secretly as "the chain". Vril members wore a Doppelsignet disc that represented the two mediums Maria Orsic and Sigrun.

The first purely Vril disc - the Vril 1 Jager (Hunter) was constructed in 1941 and first flew in 1942.

It was 11.5 meters in diameter, had a single pilot, and could achieve 2,900 km/h - 12,000 km/h! It flew with a metal dome at first but subsequent test versions had a heavily reinforced glass dome and could seat two crew. Flight endurance was 5.5 hrs. It was planned to arm this craft with two MK-108 cannon plus 2 MG-17 machineguns. Seventeen of these craft were constructed and tested between 1942-44 with 84 test flights

The Vril 2 Zerstoror (Destroyer) was a highly advanced oval shaped disc that was much too complex for the time period; thus it was projected for 1945/46, so no construction was started. The Vril 3 and 4 have been photographed but no surviving information is found on them. Vrils 5 and 6 likewise do not show up and may have only been projects. The Vril 7 and 8, however, were constructed.

The Vril 7 Geist (Ghost) was 45 meters in diameter and crewed by fourteen men. It was built in 1944 and tested at Arado-Brandenburg using Vril's own Triebwerk.

Vril's medium Sigrun made frequent trips to the facility to oversee construction and testing. In 1944, Arado engineers approached her with a request. They wanted to know if the Vril Triebwerk could be adapted to one of their projects- the Arado E.555 strategic bomber. They were abruptly told , "No" and returned to their designs which resulted in eleven different versions of the bomber.

Sigrun was actually insulted because the entire purpose of the Vril discs was aimed at space flight. No conventional bomber could withstand the heat of the velocity achieved by these machines which were constructed of hulls specially made of an advanced metal called Viktalen (in some sources Victalen or Viktalon). The Vril 1 had a single hull of this type, the Vril 7 two. The large Haunbeu III had three!

With the SS supervising all aspects of the disc programs every model had to have at least theoretical provision for armament. In the Vril 7 Geist it would have been four MK-108 cannon.

The Vril 8 Odin was the last official Vril disc that was flight tested in the spring of 1945 during the collapse. This disc had an automatic Oberon upward-firing gun installation on top of the control center.

The Vril Gesellschaft had started evacuating to Base 211 in [Neu Schwabenland Antarctica](#) in March 1945 so it would seem like the Vril 8 Odin was the last Vril disc actually tested. However, some weeks after Germany surrendered both Haunebu and Vril craft were spotted in the skies over

occupied Germany. Although the Vril 9 Abjager (Universal Hunter) was shown as a design on paper, a craft identical to it was photographed postwar.

Vril's final plan was the construction of a large 139 meter long cylindrical Raumschiff known by the SS E-IV Unit as the **Andromeda-Gerat**. Work on this "flying cigar" was to commence in 1945 at a huge, sheltered above-ground Zeppelin-like hangar. Once completed it could internally accommodate one large Haunebu IV and two Vril 2 craft, making the journey to Aldebaran, the ultimate dream of the Vril Gesellschaft.

Although these mysterious craft seem to come from the realm of *science fiction* it is interesting to note that once Germany was occupied and the military Intel teams swept through the defeated nation all documentation and evidence of the Vril Gesellschaft was destroyed by the Allies.

If the occult Society and craft never existed and did not represent any threat to the Allies then why has all trace of their existence been forcefully carried out by the victors?

"Not all good comes from above".

For Vril it came "from beyond... 68 light years from earth" and it was this obsession that led to ALL of the occult German disc programs. One can only wonder if any of them truly made it to their ultimate destination?

**Rob Arndt**

---

Vr  
il  
2  
(Project)

Vr  
il  
3

Vr  
il  
4

Vr  
il  
5

Vr  
il  
6

---



"VRIL-0014"

Verstärkte Frontscheibe (Überbleibsel eines Blüthenkohlensauerstoffes nach dem Sprengkopf)

- 1) Einwärts- und Auswärts der Kanonik
- 2) Kanonik
- 3) Vertikale Abgrenzung
- 4) Eingangsöffnung
- 5) Eingangsöffnung
- 6) Eingangsöffnung
- 7) Die Kanonik
- 8) Ausgangsöffnung
- 9) Frontscheibe
- 10) Seitenkanal (Chassis-Ring)

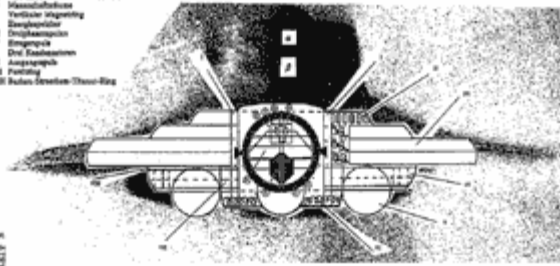

MOULDERBY 8

- 1) Einwärts- und Auswärts der Kanonik
- 2) Kanonik
- 3) Vertikale Abgrenzung
- 4) Eingangsöffnung
- 5) Eingangsöffnung
- 6) Eingangsöffnung
- 7) Die Kanonik
- 8) Ausgangsöffnung
- 9) Frontscheibe
- 10) Seitenkanal (Chassis-Ring)

[click to enlarge](#)

Vr  
il  
9  
(design)

SS-V9

-VRIL 9  
AUSWÄRTER

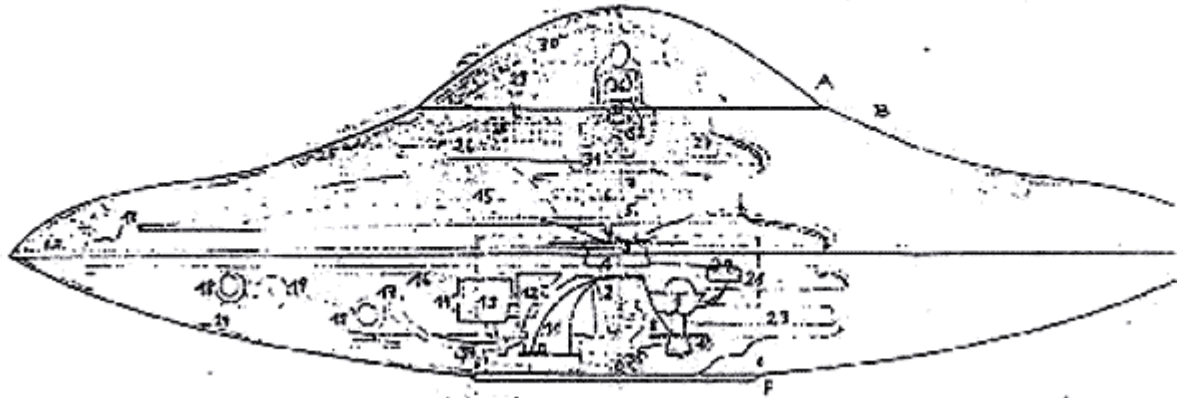





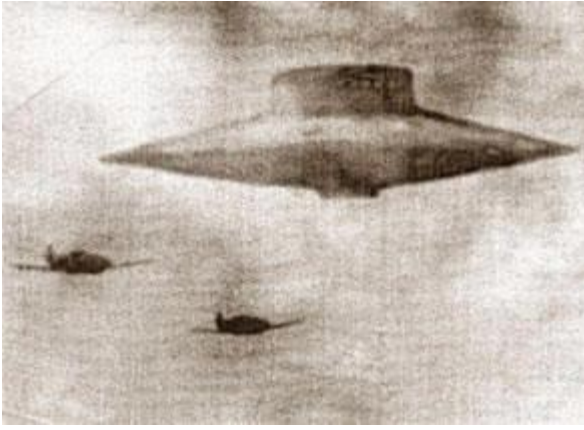

[Return](#)

Vril 7      Schnittbild mit Antrieb      Mannschaft

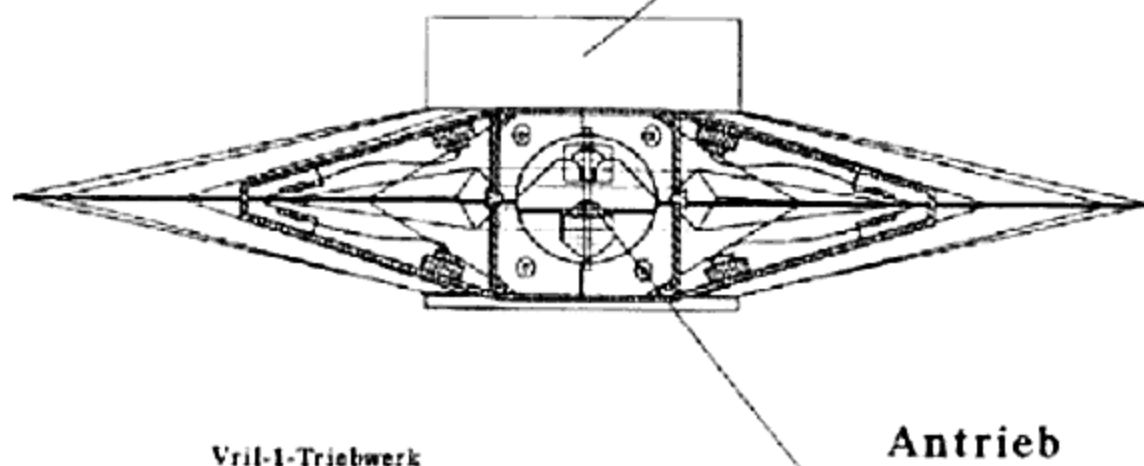

Vril-1-Triebwerk

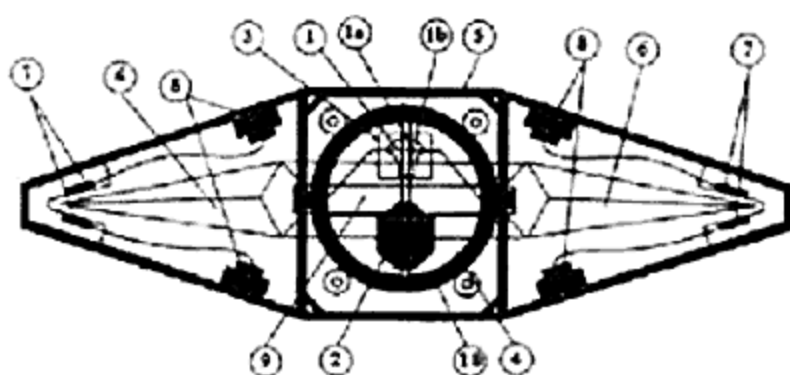

- |                              |                             |                       |
|------------------------------|-----------------------------|-----------------------|
| 1 Gleite                     | 4 Schwingungseinschluß      | 10 Schwingungsspanner |
| 1a YX - Pol                  | 5 Rahmen                    |                       |
| 1b XY - Pol                  | 6 Drehkörper                |                       |
| 2 Haupt- u. Anlauf Generator | 7 Elektromagnete            |                       |
| 3 Glockenzmantel             | 8 Stromspolier u. Aufnehmer |                       |
|                              | 9 Vakuum                    |                       |

Gemeinschaft des Schwarzen Steins



Rekonstruktionsversuch

Durchmesser des Geräts ca. 45 m

"VRIL-ODIN"

Vereinfachte Planskizze (Querschnitt) eines Elektrogravitationsraumschiffes nach dem Dynamoprinzip

- a) Kommando- und Steuerraum des Raumschiffes
- β) Mannschaftsräume
- I Vertikaler Magnetring
- II Energiespeicher
- III Dreiphasenspulen
- IV Erregerpule
- V Drei Kondensatoren
- VI Ausgangspule
- VII Ferritring
- VIII Barium-Strontium-Titanat-Ring

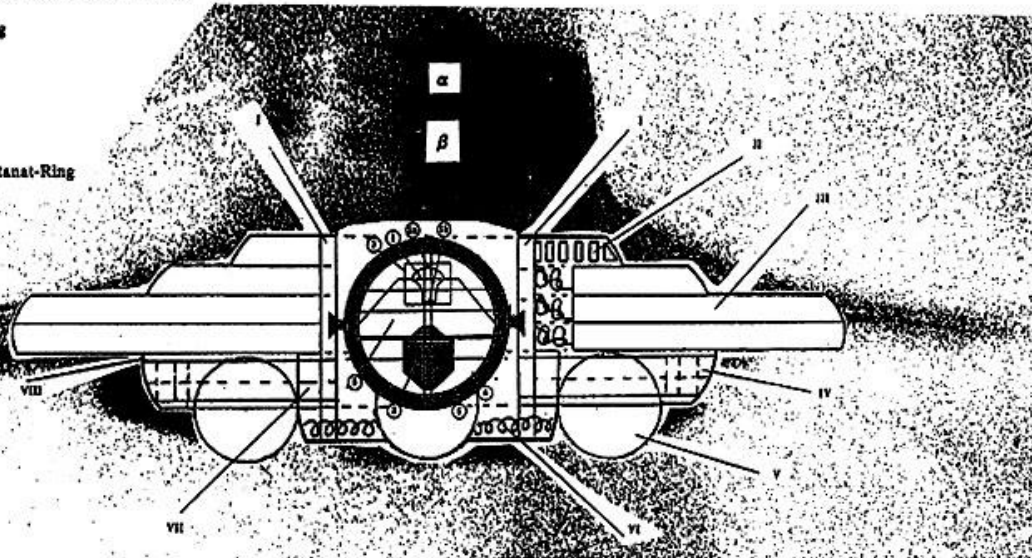

MÖGLICHKEIT B

- 1 Glocke
- 1a YX - Pol
- 1b XY - Pol
- 2 Haupt- u. Anlauf Generator
- 3 Glockenmantel
- 4 Schwingungsabschließ
- 5 Vakuum
- 6 Schwingungsanzug

JF  
M

Jenseitsflugmaschine (Other World Flight Machine)

(1922-1924)

by Rob Arndt



"Germany's first disc"

In the summer of 1922 in a small barn outside of Munich the occult *Thule* and *Vril Gesellschafts* set about to create an *interdimensional flight machine* based upon channeled information received by their two mediums (**Maria Orsich** and **Sigrun**) from *Aldeberan* in the *Taurus Constellation*, 68 light years away.

**Maria**, the **Thule medium**, had been receiving information from what she believed was **Aryan aliens** living on **Aldeberan** since 1919 but could not translate their language and strange mental images.

**Sigrun**, the **Vril medium** was brought in to help translate these communications and images which was in the form of a strange circular flight machine with an even stranger cylindrical powerplant beyond all conventional science of the time.

**Thule** and **Vril** secretly called this craft the **Jenseitsflugmaschine**, or "**Other World Flight Machine**". The **Gesellschafts** then used their members in the German business community to raise funds for the construction of this machine under the code letters **J-F-M**.

By 1922, parts for the machine began arriving independently from various industrial sources paid in full by the **Thule** and **Vril Gesellschafts**.

The machine itself was a disc craft with three inner disc plates inside and a cylindrical power unit running through the center of all three plates. The central disc plate measured 8 meters in diameter; above it in parallel was a disc plate of 6.5 meters diameter and below an equally parallel disc of 7 meters diameter. Through the center of all three disc plates ran a 2.4 meter high cylindrical power unit that fit into a running 1.8 meter hole that culminated at the bottom of the disc body with a conical point to which was attached an enormous pendulum to stabilize the equipment once the unit was operating.

Once activated, the cylindrical power unit which consisted of an electric starter motor and high power generator started the upper and lower disc plates spinning in opposite directions to create a rotating electromagnetic field that was increasingly intensified. The intensity and frequency of the field oscillations increased in theory up to a point where an **interdimensional** oscillation occurred, opening a gateway or portal to another world. The **occultists** called this a "**white hole**" that theoretically would connect the **JFM** to **Aldeberan's** corresponding frequency oscillations and navigate the machine through to that world. The sole purpose of this machine was to reach **Aldeberan** and make contact directly with those that had supplied the information through channeling.

Two years of research was done with the **JFM** until 1924 when the machine was hurriedly dismantled and moved to Augsburg where it eventually was placed in storage at **Messerschmitt's** facility. With the end of the war, no trace was ever found of the **JFM**. Perhaps it was destroyed in an Allied bombing raid or simply taken apart by the Germans themselves out of fear. No one is certain.

But whether or not the **JFM** actually worked, one thing is certain: the **Thule** and **Vril Gesellschafts**, with the help of **W.O. Schumann** of the **Technical University of Munich**, developed some form of levitator unit from it that would be utilized in further German disc aircraft with the **RFZ (Rundflugzeug)** types starting in 1934 and ending with the fantastic **Vril** and **Haunebu** discs of 1939-1945.

Return



Reich of  
The Black Sun  
Nazi Secret Weapons and The Cold War Allied Legend

## Contents

### Preface

#### **PART ONE - GOTTERDAMMERUNG**

1. A BADLY WRITTEN FINALE
2. ELECTRICITY, SLAVES, AND "BUNA"
3. U-234, U-235, AND THE STRANGE CASE OF THE MISSING URANIUM
4. "MEIN HUT ER HAT DREI ECKEN" - THE TEST SITES
5. STRANGE MAPS, STRANGE FLIGHTS, AND UNKNOWN CARGOES
6. THE STRANGE CASE OF THE DISAPPEARING GENERALS - SS OBERGRUPPENFUHRER DR. ING. HANS KAMMLER AND GENERAL GEORGE S. PATTON
7. THE HONORARY ARYAN BRETHERN
8. THE HEERESWAFFENAMT AND HOUTERMANS MEMORANDA
9. POPENSPIEL BEI FARM HALL AND OTHER FARCES
10. GATEWAY TO THE BLACK SUN - CONCLUSIONS TO PART ONE

#### **PART TWO - THE MYTH OF SURVIVAL AND THE REALITY OF PAPERCLIP**

11. THE BLACK ORDER - THE OCCULT INFLUENCE ON NAZI SECRET WEAPONS
12. THE ALCHEMY OF ATLANTIS - AN INVENTORY OF NAZI SECRET WEAPONS AND THEIR HISTORICAL PROBLEMATIC
13. QUANTUM NUMEROLOGY AND VORTICULAR PHYSICS, NAZI STYLE

#### **PART THREE - AFTERMATH**

14. THE ANTARCTIC SHANGRI-LA
15. THE PHOENIX RISES - THE BORMANN PLAN
16. ROSWELL - THE "ET MYTH" VS. THE "NAZI LEGEND": AN EXAMINATION OF SOME MJ-12 DOCUMENTS
17. THE KECKSBURG ACORN RINGS THE BELL
18. FINAL THOUGHTS

**APPENDIX** - A Short Note on the Kraftstrahlkannone

[Return to The Vrll Society](#)  
[Return to Temas / Sociopolitica](#)  
[Return to German Disc Aircrafts](#)  
[Return to Temas / Libros-Tratados](#)  
[Return to The Saga of Flying Objects](#)  
[Return to I.G. Farben - Pharmaceuticals and Criminal Organization](#)  
[Return to Germany's ET Contacts? - Its Legacy On The Twentieth Century And After...](#)

## Preface

When I was a boy, oddities fascinated me, particularly if they appeared to make no sense. Historical oddities or anomalous news stories especially attracted my interest, lingering in my mind for years to come. Like many Americans, I well remember where I was when President Kennedy was assassinated. I was home, sick, and watching television, sipping an endless stream of the chicken noodle soup that my mother always made for me when I was ill. My mother sat on the sofa, sewing and watching her shows. Then, the programs were interrupted by the familiar voice of Walter Cronkite, and the news began to break. Like many children in America, I cried that night.

A year or so later when the Warren Report was published and excerpted in almost every newspaper in the country, I remember thinking "bullets just don't do that." And I listened intently as family members debated the official conclusions of Oswald, the "lone nut" in his Texas School Book Depository, versus what was beginning to emerge with the "Grassy Knoll."

As a teenager I became fascinated with the history of World War Two, and particularly the European theater and the race for the atomic bomb. Physics was also an interest for me, and another oddity lodged in my mind as I read the standard histories: the United States had never tested the uranium bomb it dropped on Hiroshima. I thought that was an extremely odd oddity indeed. It seemed to have the same sharp angles and corners as the Warren Commission's "magic bullet". It just didn't fit. Other odd facts accumulated over the years as if to underline the strangeness of the war's end in general and that fact in particular.

Then, in 1989, the Berlin Wall came down and the two post-war Germanys raced toward reunification. The events seemed to unfold faster than the news media's ability to keep pace. I remember that day too, for I was driving with a friend in his van in Manhattan. My friend was Russian, as was his family, some of whom were veterans of the harsh conflict on the Russian front. We listened to the reports on the radio with a kind of breathlessness and anxiety.

My friend hurried to me and said "Now it will start to come out in the wash." I nodded in agreement. We had often discussed what would happen in the eventuality of German reunification, and were agreed that many things from the end of the war would begin to surface, answering old questions and raising new ones. Our long talks about World War Two had convinced us that there was much about the war that did not make sense, Hitler's and Stalin's genocidal paranoia notwithstanding.

Gradually, and one must say, predictably, the Germans themselves raced to uncover what lay hidden in the formerly inaccessible archival vaults of East Germany and the Soviet Union. Witnesses came forward, and German authors endeavored to come to grips with yet another aspect of the darkest period in their nation's history. Much, if not all, of their work remains ignored in the U.S.A., both by mainstream and by alternative researchers.

This present book is based in part on these Germans' efforts. It, like them, raises dangerous questions, and often presents dangerous and disturbing answers. As a consequence, while the Nazi regime's "image" becomes even more blackened, the image of the victorious Allies also suffers to a great degree. This book presents not only a radically different history of the race for the bomb, but also outlines a case that Germany was making enormous strides toward acquisition of a whole host of second and third and even fourth generation weapons technologies even more horrific in their destructive power.

That in itself would not be too unusual. After all, there have been a wealth of books on World War Two German secret weapons projects and their astonishing results. Those seeking new technical data on these weapons will find some new material here, for the thrust of the book is not on the weapons per se. Rather, the present work seeks a context within Nazi ideology and in some aspects of contemporary theoretical physics for these projects.

This book argues that the Nazis' quest for this barbarous arsenal of prototypical "smart weapons" and weapons of mass destruction was intimately linked to the Nazi racial and genocidal ideology and war aims, to the machinery, bureaucracy, and technologies of mass death and slavery that the Nazis had perfected. Even more darkly, this relationship points to a hidden core of occult beliefs and practices that, allied with certain very "German" advances in physics, e.g., quantum mechanics, drove their quest for ultimate weapons.

Accordingly, this is not a work of history. But neither is it a work merely of fiction. It is best described as a case of possibilities, of speculative history. It is an attempt to make sense, by means of a radical hypothesis placed within a very broad context, of events during and after the war that make no sense.

I would like to thank Mr. Frank Joseph of Fate magazine for encouraging me to write about these ideas, after he had patiently listened to me outline them while we were both attending a conference in 2003. And I would like to thank the many people -too numerous to mention - who listened, read, and critiqued the book along the way.

**Joseph P. Farrell**  
Tulsa, Oklahoma

[Back to Contents](#)

## Chapter 1

### A Badly Written Finale

"In southern Germany, meanwhile, the American Third and Seventh and the French First Armies had been driving steadily eastward into the so-called 'National Redoubt'.... The American Third Army drove on into Czechoslovakia and by May 6 had captured Pilsen and Karlsbad and was approaching Prague."

**F. Lee Bennis,**  
**Europe Since 1914 In Its World Setting** <sup>1</sup>

<sup>1</sup> F. Lee Bennis, *Europe Since 1914 In Its World Setting* (New York: F.S. Crofts and co., 1946), p. 630.

The end of the Second World War in Europe, at least as normally recounted, does not make sense, for in its standard form as learned in history books that history resembles nothing so much as a badly written finale to some melodramatic Wagnerian opera.

On a night in October 1944, a German pilot and rocket expert by the name of **Hans Zinsser** was flying his Heinkel 111 twin engine bomber in twilight over northern Germany, close to the Baltic coast in the province of Mecklenburg. He was flying at twilight to avoid the Allied fighter aircraft that at that time had all but undisputed mastery of the skies over Germany. Little did he know that what he saw that night would be locked in the vaults of the highest classification of the United States government for several decades after the war.

And he certainly could not have been aware of the fact when his testimony finally was declassified near the end of the millennium, that what he saw would require the history of the Second World War to be rewritten, or at the very minimum, severely scrutinized. His observations on that one night on that one flight resolve at a stroke some of the most pressing questions and mysteries concerning the end of the war. By the same token, what he saw raises many more mysteries and questions, affording a brief and frightening glimpse into the labyrinthine world of Nazi secret weapons development.

His observations open a veritable Pandora's box of horrifying research the Third Reich was conducting, research far more horrendous in its scope and terrible promise than mere atomic bombs. More importantly, his observations also raise the disturbing question of why the Allied governments - America in particular - kept so much classified for so long.

What, really, did we recover from the Nazis at the end of the war?

But what precisely is that badly written finale?

To appreciate how badly written a finale it truly is, it is best to begin at the logical place: in Berlin, far below ground, in the last weeks of the war. There, in the bizarre and surreal world of the Fuhrerbunker, the megalomaniac German dictator huddles with his generals, impervious to the rain of Allied and Soviet bombs that are reducing the once beautiful city of Berlin to piles of rubble.

Adolph Hitler, Chancellor and Fuhrer of the ever-diminishing Greater German Reich is in conference. His left arm shakes uncontrollably and from time to time he must pause to dab the drool that occasionally oozes from his mouth. His complexion is gray and pallid; his health, a shambles from the drugs his doctors inject in him. His glasses are perched on his nose as he squints at the map before him.<sup>2</sup>

<sup>2</sup> Contributing yet another nuance to the end of the war Legend of Hitler's delusional insanity, some have proposed that the German dictator's doctors had diagnosed him with heart disease and/or Parkinson's disease, and were keeping him drugged at the behest of Msrs Bormann, Gobbels, Himmler et al. in a desperate attempt to keep him functioning.

<sup>3</sup> Generaloberst: i.e., Colonel General, the equivalent of a four star American general.

Generaloberst<sup>3</sup> Heinrici, commander of the vastly outnumbered Army Group Vistula that faces the massed armies of Marshal Zhukov poised less than sixty miles from Berlin, is pleading with his leader for more troops. The general is questioning the disposition of the forces he sees displayed on the battle map, for it is clear to him that some of Germany's finest and few remaining battle worthy formations are far south, facing Marshal Koniev's forces in Silesia. These forces were thus, incomprehensibly, poised to make a stiff defense of Breslau and Prague, not Berlin. The general pleads for Hitler to release some of these forces and transfer them north, but to no avail.

"Prague," the Fuhrer responds stubbornly, almost mystically, "is the key to winning the war." Generaloberst's Heinrici's hard-pressed troops must "do without."<sup>4</sup>

One may also perhaps imagine Heinrich and the other assembled generals perhaps casting a doleful glance at Norway on the situation map, where thousands of German troops are still stationed, occupying a country that had long since ceased to be of any strategic or operational value to the defense of the Reich. Why indeed did Hitler maintain so many German troops in Norway up to the very end of the war?<sup>5</sup>

5 The standard versions, of course, are that he wished to maintain the supply line of iron ore from Sweden to Germany, and that he wished to continue to use the country as a base to interdict the lend-lease supply route to Russia. But by late 1944, with the huge losses of the German Kriegsmarine, these explanations no longer were militarily feasible, and hence do not make military sense. One must look for other reasons, if indeed there are any beyond Adolph Hitler's delusions.

These paradoxical German troops deployments are the first mystery of the badly written finale of the war in Europe. Both Allied and German generals would ponder it after the war, and both would write it off to Hitler's insanity, a conclusion that would become part of the "Allied Legend" of the end of the war. This interpretation does make sense, for if one assumed that Hitler were having a rare seizure of sanity when he ordered these deployments, what possibly could he have been thinking? Prague? Norway? There were no standard or conventional military reasons for the deployments. In other words, the deployments themselves attest his complete lack of touch with military reality. He therefore had to have been quite insane.

But apparently his "delusional insanity" did not stop there. On more than one occasion during these end-of-the-war conferences with his generals in the Fuhrerbunker, he boasted that Germany would soon be in the possession of weapons that would snatch victory from the jaws of defeat at "five minutes past midnight." All the Wehrmacht had to do was hold out a bit longer. And above all, it must hold Prague and lower Silesia.

They did in fact "do without" and yet managed to put up a fierce resistance against overwhelming odds in the initial stages of Zhukov's final offensive on Berlin.

Of course, the standard historical interpretation of these and similar utterances by the Nazi leadership near the end of the war explains them - or rather, explains them away - by one of two standard techniques. One school understands them to refer to the more advanced versions of the V-1 and V-2, and on rare occasions, the intercontinental A9/10 rockets, the jet fighters, anti-aircraft heat-seeking missiles, and so on that the Germans were developing. Sir **Roy Fedden**, one of the British Specialists sent to Germany to investigate Nazi secret weapons research after the war, left no doubt as to the deadly potential these developments held:

In these respects (the Nazis) were not entirely lying. In the course of two recent visits to Germany, as leader of a technical mission of the Ministry of Aircraft Production, I have seen enough of their designs and production plans to realize that if they had managed to prolong the war some months longer, we would have been confronted with a set of entirely new and deadly developments in air warfare.<sup>6</sup>

The other standard school of interpretation explains such remarks of the Nazi leadership as the utterances of madmen desperate to prolong the war, and hence their lives, by stiffening the resistance of their exhausted armies. For example, to make the insanity gripping the Reich government complete, Hitler's ever-faithful toady and propaganda minister, Dr. **Josef Goebbels** also boasted in a speech near the end of the war that he had seen "weapons so frightening it would make your heart stand still." More delusional ravings of a Nazi madman.

6 Sir Roy Fedden, *The Nazis' V-Weapons Matured Too Late* (London: 1945), cited in Renato Vesco and David Hatcher Childress, *Man-Made UFOs: 1944-1994*, p. 98.

But on the Allied side of the Allied Legend, things are equally peculiar. In March and April of 1945, US General George S. Patton's Third Army is literally racing across southern Bavaria, as fast as is operationally possible, making a beeline for:

- (1) the huge Skoda munitions works at Pilsen, a complex all but blown off the map by Allied bombers
- (2) Prague
- (3) A region of the Harz Mountains in Thuringia known to Germans as the Dreiecks or Three Corners," a region encompassed by the old mediaeval towns and villages of Arnstadt, Jonastal, Wechmar, and Ohrdruf.<sup>7</sup>

7 Arnstadt is where the great German composer and organist J.S. Bach first began his career.

One is informed by countless history books that this maneuver was thought to be necessary by the Supreme Headquarters of the Allied Expeditionary Force (SHEAF) because of reports that the Nazis were planning to make a last stand in the "Alpine National Redoubt", a network of fortified mountains stretching from the Alps to the Harz Mountains. The Third Army's movements, so the story goes, were designed to cut off the "escape route" of Nazis fleeing the carnage



of Berlin. Maps are produced in old history books, accompanied in some cases by de-classified German plans -some dating from the Weimar Republic! - for just such a redoubt. Case settled.

However, there is a problem with that explanation. Allied aerial reconnaissance would likely have told Eisenhower and SHAEF that there were precious few fortified strong points in the "National Redoubt". Indeed, it would have told them that the "Redoubt" was no redoubt at all. General Patton and his divisional commanders would most certainly have been privy to at least some of this information. So why the extraordinary and almost reckless speed of his advance, an advance the post-war Allied Legend would have us believe was to cut off the escape route of Nazis fleeing Berlin, who it turns out weren't fleeing, to a redoubt that didn't exist? The mystery deepens.

Then, remarkably, in a strange twist of fate, General Patton himself, America's most celebrated general, dies suddenly, and, some would say, suspiciously, as a result of complications from injuries he sustained in a freak automobile accident soon after the end of the war and the beginning of the Allied military occupation. For many, there is little doubt that Patton's death is suspicious.

But what of the explanations offered for it by those who do not think it was accidental? Some propose he was eliminated because of his remarks about turning the Germans "right back around" and letting them lead an Allied invasion of Russia. Others believe he was eliminated because he knew about the Allies' knowledge of the Soviets' execution of British, American, and French prisoners of war, and threatened to make it public. In any case, while Patton's barbed tongue and occasional outbursts are well known, his sense of military duty and obligation were far too high for him to have entertained such notions. These theories play out best, perhaps, on the internet or in the movies. And neither seems a sufficient motivation for the murder of America's most celebrated general. But then, if he was murdered, what was sufficient motivation?

Here too, the lone German pilot Hans Zinsser and his observations afford a speculative key as to the possibilities, if General Patton was murdered, of why he had to be silenced. Let us return, for a moment, to a less-well publicized explanation for his end-of-the war lightning-like strikes into south central Germany and into Bohemia:

In *Top Secret*, **Ralph Ingersoll**, an American liaison officer at S.H.A.E.F., gives a version of the facts much more in line with German intentions:

"(General Omar) Bradley was complete master of the situation.... in full command of the three armies that had broken through the Rhine defenses and were free to exploit their victories. Analyzing the whole situation, Bradley felt that to take battered Berlin would be an empty military victory.... The German War Department had long since moved out, leaving only a rear echelon. The main body of the German War Department, including its priceless archives, had been transferred to the Thuringian Forest..."<sup>8</sup>

But what exactly did Patton's divisions discover in Pilsen and the forests of Thuringia? Only with the recent German reunification and declassification of East German, British, and American documents are enough clues available to allow this fantastic story - and the reason for the post-war Allied Legend - to be outlined and its questions answered.

<sup>8</sup> Vesco and Childress, op. cit., p. 97.

Thus, finally, one arrives at the main theme of the post-war Allied Legend. As the Allied forces penetrated ever deeper into the German fatherland itself, teams of scientists and experts and their intelligence coordinators were sent in literally to scour the Reich for German patents, secret weapons research, and above all, to find out about the state of the German atomic bomb project.<sup>9</sup>

<sup>9</sup> "Alsos" was the code name of this effort. "Alsos" is a Greek word meaning "Grove", an obvious pun on General Leslie Groves, chief of the Manhattan Project. It is the name of the book about the Manhattan Project by Dutch-Jewish physicist Samuel Goudsmit.

Literally vacuuming the Reich of every conceivable technological development, this effort became the largest technology transfer in history. Even at this late stage of the war, as Allied armies advanced across western Europe, there was fear on the Allied side that the Germans were perilously close to the A-bomb, and might actually use one on London or other Allied targets. And Dr. Gobbels and his speeches about fearsome heart-stopping weaponry were doing nothing to alleviate their fears.

It is here that the mystery of the Allied Legend only deepens. It is here that the badly written finale would be truly comical, were it not for the vast scale of human suffering involved with it, for the facts are clear enough if one examines them independently of the explanations we have become accustomed to apply to them. Indeed, one must wonder if we were

not conditioned to think about them in a certain way, for as the Allied armies advanced deeper and deeper into the Reich, famous German scientists and engineers were either captured, or they surrendered themselves. Among them were first class physicists, many of them Nobel laureates. And most of them were involved, at some level, with the various atomic bomb projects of Nazi Germany.

Among these scientists were Werner Heisenberg, one of the founders of quantum mechanics, Kurt Diebner, a nuclear physicist, Paul Hartek, a nuclear chemist, Otto Hahn himself, the chemist who actually discovered nuclear fission, and curiously, Walter Gerlach, whose specialty was not nuclear, but gravitational physics.

**Gerlach** had written esoteric papers before the war on such abstruse concepts as spin polarization and vorticular physics, hardly the basics of nuclear physics, and certainly not the sort of scientist one would expect to encounter working on atom bombs.<sup>10</sup>

10 Nick Cook, *The Hunt for Zero Point*, p. 194. Cook notes that these areas have little to do with nuclear physics, much less A-bomb design, but "much to do with the enigmatic properties of gravity. A student of Gerlach's at Munich, O.C. Hilgenberg, published a paper in 1931 entitled 'About Gravitation, Vortices and Waves in Rotating Media'.... And yet, after the war, Gerlach, who died in 1979, apparently never returned to these matters, nor did he make any references to them; almost as if he had been forbidden to do so. That, or something he had seen...had scared him beyond all reason."

Much to the Allies' puzzlement, their scientific teams found but crude attempts by Heisenberg to construct a functioning atomic reactor, attempts that were wholly unsatisfactory and unsuccessful, and almost unbelievably inept. This "German ineptitude" in basic bomb physics became, and remains, a central component of the Allied Legend. And yet, that itself raises yet another mystery of the badly written finale.

Top German scientists - Werner Heisenberg, Paul Hartek, Kurt Diebner, Erich Bagge, Otto Hahn, Carl Friedrich von Weizsacker, Karl Wirtz, Horst Korsching, and Walter Gerlach - were carted off to Farm Hall, England, where they were kept in isolation, and their conversations recorded. The transcripts, the celebrated "Farm Hall Transcripts", were only declassified by the British government in 1992! If the Germans were so far behind and so incompetent, why keep them classified for so long?" Bureaucratic oversight and inertia? Or did they contain things the Allies did not wish to be known even at that late date?

What a surface reading of the transcripts reveals only deepens the mystery considerably. In them, **Heisenberg** and company, after hearing of the a-bombing of Hiroshima by the Americans on the BBC, debate the endless moral issues of their own involvement in the atomic bomb projects of Nazi Germany.

11 It was Manhattan project chief General Leslie Groves who, in fact, revealed in his 1962 book about the bomb, *Now It Can Be Told*, that the German scientists' conversations had been recorded by the British. Apparently, however, not everything could be told in 1962.

But that is not all.

In the transcripts, Heisenberg and company, who had suffered some inexplicable mathematical and scientific dyslexia during the whole six years' course of the war, the same Heisenberg and company who could not even design and build a successful atomic reactor to produce plutonium for a bomb, suddenly become Nobel laureates and first rank physicists after the war. Indeed, Heisenberg himself within a matter of a few days of Hiroshima, gave a lecture to the assembled German scientists on the basic design of the bomb.

In it, he defends his first assessment that the bomb would be about the size of a pineapple, and not the one or two ton monster he maintained throughout most of the war. And as we shall discover in the transcripts nuclear chemist **Paul Hartek** is close - perilously close - to the correct critical mass of uranium for the Hiroshima bomb.<sup>12</sup>

12 Q.v. Paul Lawrence Rose, *Heisenberg and the Nazi Atomic Bomb project: A Study in German Culture* (Berkeley: 1998), pp. 217-221. Thomas Powers notes of Heisenberg's lecture that "this was something of a scientific tour de force -to come up with a working theory of bomb design in so short a time, after years of laboring under fundamental misconceptions." (Thomas Powers, *Heisenberg's War: The Secret History of the German Bomb* (1993), pp. 439-440). Samuel Goudsmit, of course, used the transcripts to construct his version of the Allied Legend:

"That the German scientists were at odds with one another, that they didn't understand bomb physics, and that they concocted a false story of moral scruples to explain their scientific failures.... The sources of Goudsmit's conclusions are all obvious in the transcripts, but what leaps out at the reader now are the many statements which Goudsmit failed to notice, forgot, or deliberately overlooked." (Ibid., p. 436)

This demonstrable mathematical prowess raises yet another question directly confronting the Allied Legend, for some versions of that Legend would have it that the Germans never aggressively pursued bomb development because they had - via Heisenberg -overestimated the critical mass by several order of magnitude, thus rendering such a project impractical.

Hartek had clearly done the calculations before, so Heisenberg's estimates were certainly not the only calculations the Germans had available to them. And with a small critical mass comes the practical feasibility of an atomic bomb.

In his August 14, 1945 "lecture" to the assembled German Farm Hall physicists, Heisenberg, according to Paul Lawrence Rose, used a tone and phrasing that indicated that "he has only just now understood the solution" to a small critical mass for the bomb,<sup>13</sup> since "others" reported a critical mass of about 4 kg. This too only deepens the mystery. For Rose, an adherent of the Legend - though now in its highly modified post-Farm Hall declassification mode - the "others" could be the Allied press reports themselves.<sup>14</sup>

13 Q.v. Paul Lawrence Rose, *Heisenberg and the Nazi Atomic Bomb Project: A Study in German Culture* (Berkeley: 1998), pp. 217-221. Thomas Powers notes that this lecture was "something of a scientific tour de force - to come up with a working theory of bomb design in so short a time, after years of laboring under fundamental misconceptions." (*Heisenberg's War: The Secret History of the German Bomb*(1993), pp. 439-440).

14 *Ibid.*, p. 218.



**Dutch-Jewish Manhattan Project Physicist Samuel Goudsmit**

In the years immediately after the war, the Dutch-Jewish Manhattan Project physicist **Samuel Goudsmit** explained the whole mystery, along with many others, as being simply due to the Allies having been "better" nuclear scientists and engineers than the very Germans who had invented the whole discipline of quantum mechanics and nuclear physics. That explanation, in conjunction with Heisenberg's own self-evidently clumsy attempts to construct a functioning reactor, served well enough until these transcripts were declassified.

With the appearance of the transcripts and their stunning revelations of Heisenberg's actual knowledge of atomic bomb design, and some of the other scientists' clear understanding of the means to enrich enough weapons grade uranium without having to have a functioning reactor, the Legend had to be "touched up" a bit. Thomas Powers' *Heisenberg's War* appeared, arguing somewhat persuasively that Heisenberg had actually sabotaged the German bomb program.

And almost as soon as it appeared, **Lawrence Rose** countered with *Heisenberg and the Nazi Atomic Bomb Project*, arguing even more persuasively that Heisenberg had remained a loyal German and had not sabotaged anything, but that he simply labored under massive misconceptions of the nature of nuclear fission, and consequently over-calculated the critical mass needed to make a bomb during the war. The Germans never obtained the bomb, so the new version goes, because they never had a functioning reactor by which to enrich uranium to plutonium to make a bomb. Besides, having grossly overestimated the critical mass, they had no real impetus to pursue it. Simple enough, case closed once again.

But again, neither Powers' nor Rose's books really go to the heart of the mystery, for the Legend still requires the belief that "brilliant nuclear physicists including Nobel prize winners before the war, apparently struck by some strange malady which turned them into incompetent bunglers during the... War,"<sup>15</sup> were suddenly and quite inexplicably cured of the malady within a few days of the bombing of Hiroshima! Moreover, two such widely diverging contemporary interpretations of the same material - Rose's and Powers' - only highlights the ambiguity of their contents in general, and Heisenberg's knowledge - or lack of it - in particular.

15 Philip Henshall, *The Nuclear Axis: Germany, Japan, and the Atom Bomb Race 1939-45*, "Introduction."

Matters are not helped by events on the other side of the world in the Pacific theater, for there American investigators would uncover similarly strange goings on after the war ended.

There, after Nagasaki, the Emperor Hirohito, overriding his ministers who wanted to continue the war, decided that Japan would surrender unconditionally. But why would Hirohito's ministers urge continuance of the war in the face of overwhelming Allied conventional arms superiority, and, from their point of view, facing a potential rain of atomic bombs? After all, "two" bombs could just as easily have turned into twenty. One could, of course, attribute the ministers' objections to the Emperor's intentions to "proud samurai traditions" and the Japanese sense of "honor" and so on. And that would indeed be a plausible explanation.

But another explanation is that Hirohito's cabinet ministers knew something.

What his ministers probably knew was what American intelligence would soon discover: that the Japanese,

"just prior to their surrender, had developed and successfully test fired an atomic bomb. The project had been housed in or near Konan (Japanese name for Hungnam), Korea, in the peninsula's North."<sup>16</sup>

It was exploded, so the story goes, one day after the American plutonium bomb, "Fat Man", exploded over Nagasaki, i.e., on August 10, 1945. The war, in other words, depending on Hirohito's decision, could have "gone nuclear". By that time, of course it would have done Japan no good to prolong it, with no viable means of delivery of an atomic weapon to any worthwhile strategic American targets. The Emperor stood his ministers down.<sup>17</sup>

16 Robert K. Wilcox, *Japan's Secret War*, p. 15.

17 The Japanese were, in fact, developing large cargo submarines to transport a bomb to West Coast American port cities to be detonated there, much like Einstein warned in his famous letter to President Roosevelt that initiated the Manhattan Project. Of course, Einstein was more worried about the Germans using such a method of ship-borne delivery, than the Japanese.

These allegations constitute yet another difficulty for the Allied Legend, for where did Japan obtain the necessary uranium for its (alleged) A-bomb? And more importantly, the technology to enrich it? Where did it build and assemble such a weapon? Who was responsible for its development? The answers, as we shall eventually see, possibly explain events far in the future, and even possibly down to our own day.

Yet even now, we have only begun to penetrate into the heart of this "badly written finale." There are also the "odd little, and little known, details" to consider.

Why, for example, in 1944, did a lone Junkers 390 bomber, a massive six engine heavy-lift ultra long-range transport aircraft capable of round trip intercontinental flight from Europe to North America, fly to within less than twenty miles of New York City, photograph the skyline of Manhattan, and return to Europe?<sup>18</sup> Germany launched several such top secret long-distance flights during the war, using these and other heavy-lift ultra-long range aircraft. But what was their purpose, and more importantly, the purpose of this unique flight?<sup>19</sup> That such a flight was extremely risky goes without saying. What were the Germans up to with this enormous aircraft, and why would they even risk such an operation just to take pictures, when they only ever had two of these enormous six engine monsters available?

18 Q.v. Nick Cook, *op. cit.*, p. 198, Henshall, *op. cit.*, pp. 171-172.

19 Italy, as well, launched long-range air missions to Japan.

Finally, and to round out the Legend, there are the odd details of the German surrender and the Nuremberg War Crimes Tribunals. Why does former Reichsfuhrer SS **Heinrich Himmler**, mass murderer and one of human history's most notorious criminals, try to negotiate a surrender to the Western Allies? Of course, one can dismiss this as delusion, and Himmler was certainly delusional. But what could he possibly have thought he had to offer the Allies in return for a surrender to the West, and the sparing of his own wretched life?

What of the strangeness around the Nuremberg Tribunals themselves? The Legend is well known: obvious war criminals like Reichmarschall Goring, Field Marshal Wilhelm Keitel, Army Chief of Operations Staff Colonel-General Alfred Jodl, are sent swinging from the gallows, or, in Goring's case, cheating the hangman by swallowing cyanide. Other Nazi bigwigs like Grand Admiral Karl Donitz, mastermind of Germany's devastating U-boat campaign against Allied shipping, or Minister of Armaments Albert Speer, or Finance Minister and Reichsbank President Hjalmar Horace Greeley Schacht, were imprisoned.

Missing from the docket of the accused, of course, were the Pennemunde rocket scientists headed by Dr. **Werner von Braun** and General **Walter Dornberger**, already headed to America to take charge of America's ballistic missile and space programs along with a host of scientists, engineers and technicians under the then super secret Project Paperclip.<sup>20</sup> They, like their nuclear physics counterparts in Germany, had seemingly suffered from a similar "bungler's malady", for once having produced the first successful V-1 and V-2 prototypes comparatively early in the war, they suffered a similar lack of inspiration and ingenuity and (so the Legend goes) managed to produce only "paper rockets" and theoretical study projects after that.<sup>21</sup>

But perhaps most significantly, by joint agreement of the Allied and Soviet prosecutors at Nuremberg, missing from evidence in the tribunal was the vast amount of documentary evidence implicating the Nazi regime in occult belief systems and practice,<sup>22</sup> a fact that has given rise to a whole "mythology, and one that has never been adequately explored in connection with its possible influence on the development of German secret weapons during the war.

20 The best sources on the overall outlines of Operation Paperclip are Mark Aaron's and John Loftus' *Unholy Trinity: the Vatican, Nazis, and Soviet Intelligence* (New York: St Martin's Press. 1991), and Christopher Simpson's *Blowback: America's Recruitment of Nazis and Its Effects on the Cold War* (New York: Macmillan Publishing Company. 1988).

21 Henshall, op. cit, "Introduction."

22 Q.v., Jean-Michel Angebert, *The Occult and the Third Reich* (New York: McGraw-Hill, 1974); Nicholas Goodrick-Clarke, *The Occult Roots of nazism: Secret Aryan Cults and Their Influence on nazi Ideology* (New York: New York University Press. 1992); Michael Howard, *The Occult Conspiracy: Secret Societies- Their Influence and Power in World History* (Rochester, Vermont: Destiny Books, 1989); Peter Levenda, *Unholy Alliance: A History of Nazi involvement with the Occult* (New York: Avon Books, 1995); Louis Pauwels and Jacques Bergier, *The Morning of the magicians*, trans from the French by Rollo Meyers (new York: Stein and Day, 1964); Dusty Sklar, *The Nazis and the Occult* (New York: Dorset Press, 1977); James Webb, *The Occult Establishment and The Occult Underground* (LaSalle, Illinois: Open Court, 1988). It should be noted that the SS Ahnenerbiedienst did come under the tribunal's scrutiny.

Finally, a curious fact, one of those obvious things that one lends to overlook unless attention is drawn to it: the atomic bomb test that took place at the Trinity site in new Mexico was a test of America's implosion-plutonium bomb, a test needed to see if the concept would actually work. It did, and magnificently. But what is immensely significant - a fact missing from almost all mainstream literature on the subject since the end of the war - is that the uranium bomb with its apparatus of a cannon shooting the critical mass of uranium together, the bomb that was actually first used in war, the bomb dropped on Hiroshima, was never tested. As German author Friedrich Georg notes, this tears a rather gaping hole in the Allied Legend:

Also another question is of great importance: Why was the uranium bomb of the USA, unlike the plutonium bomb, not tested prior to being hurled on Japan? Militarily this would appear to be extremely dangerous.... Did the Americans simply forget to test it, or did others already do it for them?<sup>23</sup>

23 Friedrich Georg, *Hitlers Siegeswaffen: Band 1: Luftwaffe und Marine: Geheime Nuklearwaffen des Dritten Reiches und ihre Tragersysteme* (Schleusingen: Amun Verlag, 200), p. 150, my translation.

The Allied Legend accounts for this in various ways, some ingenious, some not so ingenious, but basically they boil down to the assertion that it was never tested because it did not need to be, so confident were Allied engineers that it would work. So we have been asked to believe, by the post-war Allied spin, that the American military dropped an atomic bomb of untested design, based on concepts of physics that were very new and themselves very untested, on an enemy city, an enemy also known to be working on acquiring the atomic bomb as well!

It is indeed a badly written, truly incredible, finale to the world's most horrendous war.

So, what exactly did the German pilot **Hans Zinsser** see on that night of October, 1944, as he flew his Heinkel bomber over the twilight skies of northern Germany? Something that, had he known it, would require the previous badly written Wagnerian libretto to be almost completely revised.

His affidavit is contained in a military intelligence report of August 19, 1945, roll number A1007, filmed in 1973 at Maxwell Air Force Base in Alabama.

Zinsser's statement is found on the last page of the report:

1. A man named ZINSSER, a Flak rocket expert, mentioned what he noticed one day: In the beginning of Oct, 1944 I flew from Ludwigslust (south of Lubeck), about 12 to 15 km from an atomic bomb test station, when I noticed a strong, bright illumination of the whole atmosphere, lasting about 2 seconds.
2. The clearly visible pressure wave escaped the approaching and following cloud formed by the explosion. This wave had a diameter of about 1 km when it became visible and the color of the cloud changed frequently. It became dotted after a short period of darkness with all sorts of light spots, which were, in contrast to normal explosions, of a pale blue color.
3. After about 10 seconds the sharp outlines of the explosion cloud disappeared, then the cloud began to take on a lighter color against the sky covered with a gray overcast. The diameter of the still visible pressure wave was at least 9000 meters while remaining visible for at least 15 seconds.
4. Personal observations of the colors of the explosion cloud found an almost blue-violet shade. During this manifestation reddish-colored rims were to be seen, changing to a dirty-like shade in very rapid succession.
5. The combustion was lightly felt from my observation plane in the form of pulling and pushing.
6. About one hour later I started with an He 111 from the A/D<sup>24</sup> at Ludwigslust and flew in an easterly direction.

24 "A/D" probably "aerodrome".

Shortly after the start I passed through the almost complete overcast (between 3000 and 4000 meter altitude). A cloud shaped like a mushroom with turbulent, billowing sections (at about 7000 meter altitude) stood, without any seeming connections, over the spot where the explosion took place. Strong electrical disturbances and the impossibility to continue radio communication as by lightning, turned up.

7. Because of the P-38s operating in the area Wittenberg-Mersburg I had to turn to the north but observed a better visibility at the bottom of the cloud where the explosion occurred. Note: It does not seem very clear to me why these experiments took place in such crowded areas.<sup>25</sup>

25 The entire documentation of this report is as follows:

"Investigations, Research, Developments and Practical Use of the German Atomic Bomb," A.P.I.U. (Ninth Air Force) 96/1945 APO 696, U S Army, 19 August 1945." The report is classified secret. Note that the report begins in no uncertain terms: "the following information was obtained from four German scientists: a chemist, two physical chemists, and a rocket specialist. All four men contributed a short story as to what they knew of the atomic bomb development."

Note also the suggestive title of the report.

In other words, a German pilot had observed the test of a weapon, having all the signatures of a nuclear bomb: electromagnetic pulse and resulting malfunction of his radio, mushroom cloud, continuing fire and combustion of nuclear material in the cloud and so on. And all this on territory clearly under German control, in October of 1944, fully eight months before the first American A-bomb test in New Mexico! Note the curious fact that Zinsser maintains that the test took place in a populated area.

There is yet another curiosity to be observed in Zinsser's statement, one that his American interrogators either did not pursue, or, if they did pursue it, the results remain classified still: How did Zinsser know it was a test? The answer is obvious: Zinsser knew, because he was somehow involved, for clearly the Allies would not have control over a test site deep in Nazi Germany.

Earlier in the same report, there are clues that unravel the mystery:

14. When Germany was at this stage of the game, the war broke out in Europe. At first investigations on this disintegrating of U235 were somewhat neglected because a practical application seemed too far off. Later, however, this research continued, especially in finding methods of separating isotopes. Needless to say that the center of gravity of Germany's war effort at that time lay in other tasks.

15. Nevertheless the atomic bomb was expected to be ready toward the end of 1944, if it had not been for the effective air attacks on laboratories engaged in this uranium research, especially on the one in Ryukon in Norway, where heavy water was produced. It is mainly for this reason that Germany did not succeed in using the atomic bomb in this war.



These two paragraphs are quite revealing for several reasons.

First, what is the source for the assertion that the Germans expected the bomb to be ready in late 1944, well ahead of the Manhattan Project, and a statement in flat contradiction to the post-war Allied spin that the Germans were actually far behind? Indeed, during the war, Manhattan Project estimates consistently placed the Germans ahead of the Allies, and project chief General **Leslie Groves** also thought they were. But after the war, everything suddenly changed. Not only was America ahead, but according to the Legend, it had been consistently far ahead throughout the war.



Manhattan Project Chief General Leslie Groves

Zinsser's account raises a disturbing possibility -besides completely contradicting the Allied Legend - and that is, did the Allies learn of a German A-bomb test during the war? If so, then we may look for certain types of corroborating evidence, for the other Statements of the post-war report containing Zinsser's affidavit would seem to indicate that the Allied Legend is already beginning to take tenuous shape.

The intelligence report talks, for example, only of laboratories being the facilities conducting isotope enrichment and separation research. But mere laboratories would simply be incapable of development of an actual functioning atom bomb. So one component of the Legend emerges in this early report: the German effort was lackadaisical, being confined to laboratories.

Secondly, note the clear assertion that Germany did not succeed in "using the atomic bomb in this war." The language of the report is very clear. Yet it would also appear to be designed to obfuscate in aid of the then emerging Allied Legend, for the statement does not say that the Germans never tested a bomb, only that they did not use one. The language of the report is oddly careful, deliberate, and for that reason, all the more thought provoking.

Thirdly, note how much is actually - and inadvertently it would seem -revealed about German atomic bomb research and development, for the statements make it clear that the Germans were after a uranium based A-bomb. A plutonium bomb is never mentioned. The theory of plutonium development and the possibility of a plutonium based A-bomb were clearly known to the Germans, as a Top Secret memorandum to the Heereswaffenamt (Army Ordnance Bureau) in early 1942 makes abundantly clear.<sup>26</sup>

<sup>26</sup> This memorandum obviously constitutes another sore spot for the Allied Legend that emerged after the war, namely, that the Germans never knew the correct amount of the critical mass of a uranium fission bomb, but that it had been grossly overestimated by several orders of magnitude, hence rendering the project "unfeasible" within the span of the war. The problem of the HWA memorandum is that the Germans had a good ball-park estimate as early as January-February of 1942. And if they knew it was so small, then the resulting "decision" of the German High Command as to the impracticality of its development becomes immensely problematical. On the contrary, because of this memorandum -most likely prepared by Dr. Kurt Diebner or Dr. Fritz Houtermans - they knew that the undertaking was not only practical but feasible within the span of the war.

So it is the absence of plutonium from this report that affords us a first significant clue into what was probably the real nature of German atom bomb research. It is this absence that explains why the Germans never placed much emphasis on achieving a functioning reactor in order to enrich uranium to make weapons grade plutonium for an atom bomb: they did not need to do so, since there were other methods of enriching and separating enough U235 to weapons grade purity and a stockpile of critical mass.

In a nutshell: the Allied Legend about the German failure to obtain the atom bomb because they never had a functioning reactor is simply utter scientific nonsense, because a reactor is needed only if one wants to produce plutonium. It is an unneeded, and expensive, development, if one only wants to make a uranium A-bomb. Thus, there is sufficient reason, due to the science of bomb-making and the political and military realities of the war after America's entry, that the Germans took the decision to develop only a uranium bomb, since that afforded the best, most direct, and technologically least complicated route to acquisition of a bomb.

Let us pause a moment to put the indications of the German project in the context of the Manhattan Project taking place in the United States. There, with a production capacity larger than Germany's, and with an industrial base not being targeted by enemy bombing, the American project decided to concentrate on development of all available means to production of working atom bombs, i.e., uranium and plutonium bombs. But the production of plutonium could only be achieved in the construction of a functioning reactor. No reactor, no plutonium bomb.

But it should also be noted that the Manhattan Project also constructed the giant Oak Ridge facility in Tennessee to enrich uranium to weapons grade by gaseous diffusion and Lawrence's mass spectrometer processes, a facility that at no stage of its operation relied upon a functioning reactor in order to enrich uranium.

So, if the Germans were pursuing a similar approach to that employed at Oak Ridge, then we must find indicators to corroborate it. First, to enrich uranium by the same or similar methods as employed in Tennessee, the Reich would have had to build a similarly huge facility, or smaller facilities scattered throughout Germany, transporting the various levels of dangerous uranium isotope from one point to another as feedstock until the desired level of purity and enrichment was achieved.

The material would then have to be assembled in a bomb, and tested. So one must first look for a facilities or facilities. And given the Oak Ridge operation and its massive size, we know exactly what to look for: enormous size, close proximity to water, an adequate transportation infrastructure, enormous electrical power consumption, and finally, two other significant factors: an enormous labor pool, and enormous cost.

Secondly, in order to verify or corroborate Zinsser's astonishing affidavit, we must look for corroborating evidence. We must look for indications that the Germans had stockpiled enough weapons grade uranium to constitute a critical mass for an atom bomb. And then we must hunt for the test site or sites and see if it (or they) bear(s) the signature(s) of an atomic blast.

Fortunately, the information is now slowly coming available with the recent declassification of documents by Great Britain, the United States, the former Soviet Union, and as the archives of the former East Germany are being opened by the German government itself. This allows us to examine each of these aspects of the problem in a detail not possible until the last few years. The answers, as we shall see in the remaining chapters of part one, are disturbing, and horrifying.

[Back to Contents](#)

## Chapter 2: ELECTRICITY, SLAVES, AND "BUNA"

"Assertions made by General Groves after the war... were probably designed to divert attention from the German isotope separation program. The idea being that if the existence of the German uranium enrichment program could be hidden, then the cover story could be established that Germany's atomic bomb effort consisted only of failed attempts to create a reactor pile to breed plutonium "

**Carter P. Hydrick:** *Critical Mass: the Real Story of the Birth of the Atomic Bomb and the Nuclear Age.*<sup>1</sup>

"The men who interrogated Heisenberg and other German scientists, read their reports, and gaped at the primitive reactor vessel in a cave in southern Germany were hard put to explain what had gone wrong. Germany had begun the war with every advantage: able scientists, material resources, and the support and interest of the highest military officials. How could they have achieved so little?"<sup>2</sup>

These are the basic facts, and the central question, that have plagued every researcher into the subject of German secret weapons research since the end of World War Two. How indeed could Germany have not obtained the atom bomb?



The thesis of this book, among many others, is radical, namely, that Germany did acquire atomic bombs during the war. What must be explained, rather, is why Germany apparently did not use this and other dreadful weapons available to her, or, if she did, why we have not heard about it. But of course, to maintain such a radical thesis, one must argue persuasively that Germany had the bomb to begin with.

1 Carter Hydrick, *Critical Mass: the Real Story of the Atomic Bomb and the Birth of the Nuclear Age*, Internet published manuscript, <http://saba.fateback.com/criticalmass/begin.html>, 1998, p. 21. Hydrick's research is painstaking and meticulous, and his speculative reconstructions of the detailed history of the war's end merit close attention. It is earnestly hoped he will eventually publish this important work in book form.

2 Thomas Powers, *Heisenberg's War*, p. viii.

This implies a relatively easy set of corroborative evidence to search for. If Germany had a uranium based atom bomb, one must look for the following things:

- (1) A method or methods of separating and enriching uranium-235 isotope, the necessary isotope for a uranium atom bomb, to weapons grade quality, and in sufficient quantity to stockpile enough material for the critical mass, without the use of a functioning atomic reactor.
- (2) An actual facility or facilities where such technologies are used en masse; This implies in turn
  - (a) enormous electrical power consumption;
  - (b) adequate water and transportation supplies;
  - (c) an enormous labor pool;
  - (d) a physically large facility or facilities that are relatively shielded from Allied and/or Russian bombing;
- (3) The necessary basic theory for the design of a uranium bomb;
- (4) Available and adequate supplies of uranium for use in enrichment;
- (5) A site or sites to assemble and test the bomb

Fortunately, all these aspects of the investigation afford the researcher several clues, all of which corroborate the existence, at the minimum, of a very large and successful German uranium refinement and enrichment program during the war.

We begin by looking in a very unlikely spot: Nuremberg.

At the War Crimes Tribunal after the war, several formerly elegantly attired business executives and senior managers of the huge, enormously powerful, and quite notorious German chemicals cartel, **I.G. Farben A.G.** (*Interessen-Gemeinschaft Farbenindustrie AG*), had their time in the dock. Their story of this early "global corporation", its bankrolling of the Nazi regime and its central role in its "military-industrial complex", as well as its role in producing the deadly Zyklon-B poison gas for the death camps has been chronicled elsewhere.<sup>3</sup>

3 Joseph Borkin, *The Crime and Punishment of I. G. Farben*; Anthony C. Sutton, *Wall Street and the Rise of Hitler*.

I.G. Farben had been more than just complicit in Nazi atrocities by its construction of a large Buna, or *synthetic rubber*, production plant at Auschwitz in the Polish part of Silesia during the war, committing atrocities against the concentration camp victims during its construction and operation.

For Farben, the choice of Auschwitz as the site for the Buna plant was logical, and made for "sound business reasons." The concentration camp nearby the site selected for the enormous facility guaranteed an endless supply of slave labor for its construction, and, conveniently, when the slaves had exhausted themselves in its secret construction and operation, they could be permanently "laid off". Farben director Carl Krauch assigned one of its top Buna synthetic rubber experts, **Otto Ambros**, to investigate the sites for the proposed plant and make a recommendation. The site eventually selected - Auschwitz - was "particularly suited for the installation" over a competing site in Norway for one very important reason.

A coal mine was nearby and three rivers converged to provide a vital requirement, a large source of water. Together with these three rivers, the Reich railroad and autobahn afforded excellent transportation to and from the area. These were not decisive advantages, however, over the Norwegian site. But the Silesian location had one advantage that was overwhelming: the S.S. had plans to expand enormously a concentration camp nearby. The promise of an inexhaustible supply of slave labor was an attraction that could not be resisted.<sup>4</sup>

The selection having been approved by the Farben board, Krauch then wrote a top secret letter to Ambros:

In the new arrangement of priority stages ordered by Field Marshal Keitel, your building project has first priority.... At my request, (Goring) issued special decrees a few days ago to the supreme Reich authorities concerned.... In these decrees, the Reich Marshal obligated the offices concerned to meet your requirements in skilled workers and laborers at once, even at the expense of other important building projects or plans which are essential to the war economy.<sup>5</sup>

4 Borkin, op. cit, p. 115.

5 Ibid., pp. 115-116.

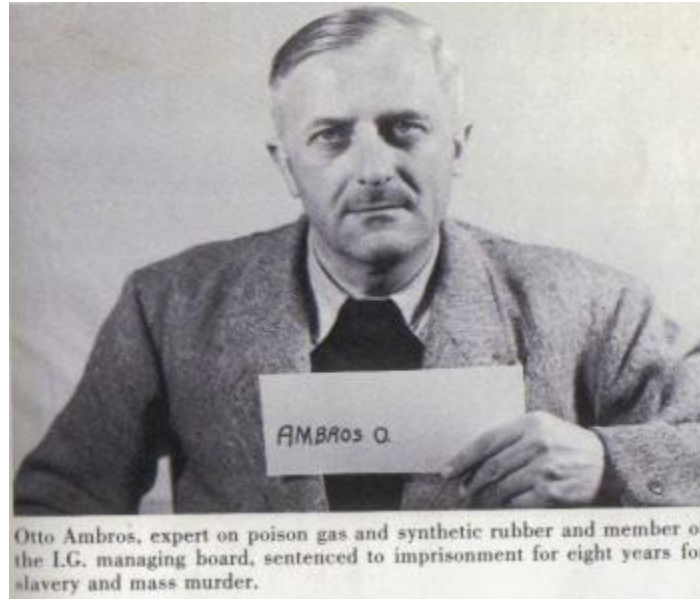

Otto Ambros, expert on poison gas and synthetic rubber and member of the I.G. managing board, sentenced to imprisonment for eight years for slavery and mass murder.

#### I.G. Farben Auschwitz "Buna" Expert Otto Ambros

With the Wehrmacht poised to blast its way into Russia soon, and sensing enormous profits to be made in the effort, the Farben directors decided to finance the enormous plant privately, rather than in concert with the Nazi regime, earmarking 900,000,000 Reichsmarks - nearly \$250,000,000 in 1945 dollars or over \$2 billion in contemporary dollars - to the project. It was to be the Buna plant to dwarf all other Buna plants.

However, as the testimony at the Nuremberg War Crimes Tribunal unfolded, the Auschwitz Buna factory emerged as one of the big mysteries of the war, for in spite of the enormous sum of money set aside for its construction, in spite of the personal blessings of Hitler, Himmler, Goring, and Keitel, and in spite of an endless supply both of skilled company contract laborers and an endless supply of slave labor from Auschwitz, "the project was continually disrupted by shortages, breakdowns, and delays.... Some malign influence seemed to be affecting the entire operation" to such an extent that Farben appeared to be faced with the first failure in its long corporate history of technological success.<sup>6</sup> By 1942, the whole effort was viewed by many directors not only as a failure, but as a near disaster.<sup>7</sup>

6 Ibid., p. 118.

7 Ibid., p. 120.

Disaster notwithstanding, the huge synthetic rubber and gasoline plants were completed, after 300,000 concentration camp workers had passed through the corporations construction mills. 25,000 of these inmates were simply and cruelly worked to death from exhaustion. The plants themselves were nothing less than gigantic. So gigantic, in fact, that "they used more electricity than the entire city of Berlin."<sup>8</sup>

During the war crimes tribunals, however, it was not this gruesome catalogue of facts about the plant that puzzled the Allied prosecutors. What puzzled them was that, in spite of such an enormous investment of lives, money, and material, "not a single pound of Buna was ever produced"<sup>9</sup> [The Farben directors](#) and managers in the docks were almost obsessively insistent on this point. More electricity than the entire city of Berlin - the eighth largest in the world at that time - to produce absolutely nothing? If this was true, then the enormous outlay of capital and labor and the huge electrical consumption contributed nothing significant to the German war effort whatsoever. Needless to say, there is something very wrong with this picture.

8 Ibid., p. 127.

9 Ibid., emphasis added.

None of it made sense then, none of it makes sense now, unless of course the plant was not a Buna plant at all...

---

When **I.G. Farben** began its construction of the "Buna" plant at Auschwitz, one of the more unusual events to being the process was the removal of over 10,000 Polish inhabitants from their homes to make way for the thousands of German scientists, technicians, contract works and their families who were moved into the area. The parallel with the Manhattan Project in this respect is obvious. It is simply unbelievable in the extreme that, with such a technical and scientific effort on the part of the corporation with the most successful track record in advanced technologies and production facilities, and a plant consuming more electricity than Berlin, that nothing whatsoever was ever accomplished or produced.<sup>10</sup>

One contemporary researcher who is also mystified by the whole "Buna plant affair" is **Carter P. Hydrick**. Contacting Ed Landry, an expert in the field of synthetic rubber production from Houston, Texas, and informing him of the I.G. Farben plant, its huge electrical consumption, and the directors' claims that it produced no Buna at all, Landry responded: "That was not a rubber plant - you can bet your bottom dollar on that." Landry simply does not believe the primary purpose of the "Buna plant" was the production of rubber at all.<sup>11</sup>

How then to account for the enormous electrical consumption and post-war insistence of Farben directors that the plant never produced any synthetic rubber at all? What other technology would require such enormous electrical power consumption, such an enormous technical and unskilled labor staff, and such close proximity to plentiful water supplies? At that time, there was only one other technological process that could conceivably require all these things. Hydrick puts the case this way:

Certainly there is something wrong with this picture. A compilation of the three central and readily known facts just outlined - electrical consumption, construction costs, and I.G. Farben's previous record - does not readily form a picture that a Buna processing plant was the type of project being constructed at Auschwitz. Such a compilation does sketch a picture, however, of another important wartime production process, though secret at the time. The process is uranium enrichment.<sup>12</sup>

So why call it a Buna plant? And why protest so vociferously to the Allied prosecutors that the plant never produced any Buna at all? One answer is that with so much labor being provided by the slave labor from the SS concentration camp nearby, the plant fell under SS security jurisdiction, and an effective "cover" would therefore be at the head of the list of Farben's and the SS' concerns.

<sup>10</sup> Carter P. Hydrick, *op. cit.*, p. 34.

<sup>11</sup> Hydrick, *op. cit.*, p. 35.

<sup>12</sup> *Ibid.*, p. 38.

In the unlikely event, for example, of an escape by one or more inmates, the "Buna" plant would have uttered a plausible cover story should the Allies ever learn of it. Since isotope separation would have been such a secret and costly process, "it becomes hard to imagine the so-called Buna installation being anything but a cover for a uranium enrichment facility."<sup>13</sup> Indeed, there is odd corroboration as we shall see from the Farm Hall transcripts. The "Buna plant" became the cover story to explain the construction to the laborers - in the event that explanations were offered at all! - and to the Farben company contract employees who were "out of the loop."

In this respect, the delays in its construction and the difficulties Farben encountered are also best explained by its being a huge isotope separation facility, not unlike those the Manhattan Project encountered when constructing its own similarly sized plant at Oak Ridge, Tennessee. Like its American counterpart, shortages and delays and technical difficulties dogged the project from its inception, and like its American counterpart, these delays were experienced in spite of its enjoying a similarly privileged position in the hierarchy of Nazi priorities as Oak Ridge.<sup>14</sup>

<sup>13</sup> Hydrick, *op. cit.*, p. 38.

<sup>14</sup> *Ibid.*

So the strange assertions and behavior of the Farben directors on trial after the war begins to make sense. Faced already with an emerging "Allied Legend" about German incompetence in nuclear matters, the Farben directors and managers were perhaps trying in a subtle way to "set the record straight" in the only way that would not overtly challenge that Legend. They were attempting, perhaps, to provide a clue as to the real nature and achievements of the German bomb program that would only be noticed over time and with careful scrutiny.

The selection of the site - near the concentration camp at Auschwitz and its hundreds of thousands of hapless victims - also makes strategic, if not gruesome, sense. Much like dictators of more recent times, it would appear that the Nazi regime had placed the facility near the camp in a deliberate attempt to use "human shields" to protect the facility from Allied bombing. If so, the decision was a correct one, as no Allied bombs ever fell on Auschwitz. The plant was dismantled only in the face of the approaching Russian armies in 1944.

## The Isotope Separation Facility at Oak Ridge, Tennessee

To establish that the "Buna plant" was most likely an isotope separation facility, however, requires that one prove the Germans possessed the technological means for isotope separation. Additionally, if such technology was employed at the "Buna plant", then it implies that there was more than one atom bomb project in Germany, for the "Heisenberg" wing of the project, and all the subsequent debates that surround it, are well known. So in addition to ascertaining whether or not Germany possessed the technology to separate isotopes, one must also attempt a broad reconstruction of the actual outlines and relationships of the various German atom bomb projects.

By stating the problem in this fashion, one is again confronted by the post-war Allied Legend:

In the traditional history of the bomb, (Manhattan project chief General Leslie) Groves has positioned the German plutonium effort as the only nuclear initiative Germany ever pursued. And he has magnified this misinformation, couched in a cushion of half-truths, to immense proportions - large enough to hide what appears to be a huge German uranium enrichment project behind it - and thus he has shielded the Nazi near-success from the view of the world.<sup>15</sup>

**15 Hydrick, op. cit., p. 3. Obviously, Hydrick himself does not appear ready to go all the way and acknowledge that the Germans actually successfully tested an atom bomb before its American Manhattan project counterpart produced and tested one.**

Did Germany have isotope enrichment technology available? And could it have employed that technology in sufficient quantity to make significant amounts of enriched uranium available for a bomb program?

There can be no doubt that Germany certainly had a sufficient supply of uranium ore, for the region of the Sudetenland - annexed by Germany after the infamous Munich conference in 1938 - is a region known for its rich deposits of some of the highest grade uranium ore in the world. The region, coincidentally, lies close to the "Three Corners" region of Thuringia in south central Germany, and therefore close to Silesia and the various installations that will be examined in parts two and three. So the Farben directors may have had another reason for choosing Auschwitz as the site for an enrichment facility. Auschwitz was close not only to water, an adequate transportation network, and abundant labor, it was conveniently close to the uranium fields of the German-Czech Sudetenland.

These facts raise a speculative possibility. It is well-known that the announcement by nuclear chemist Otto Hahn of his discovery of nuclear fission did not occur until after the Munich conference and the surrender of the Sudetenland to the Third Reich by Chamberlain and Daladier. But might the reality have been something different? Might, in fact, the discovery of fission taken place before the conference, and its results withheld by the Reich until after Europe's only uranium supply was firmly in Nazi hands? It is perhaps significant that Adolf Hitler was prepared to go to war over the matter.

In any case, before we investigate the question of the technology available to the Germans, we must first answer the question of why they apparently concentrated almost exclusively on obtaining a uranium atom bomb in their program. After all, the American Manhattan Project had elected to pursue both a uranium and a plutonium bomb. The theoretical possibility of plutonium bombs - "element 94" as it was officially called in German documents of the period - was certainly known to the Nazis. And, as the early 1942 memorandum to the Heereswaffenamt also makes clear, the Germans also knew that this element could only be synthesized in an atomic reactor.

So why did they apparently concentrate only on a uranium bomb and isotope separation and enrichment almost exclusively? With the destruction of the Norwegian heavy water plant at Ryukon in 1942 by Allied commandos, and German failures in obtaining sufficient purity of graphite for use as a moderator in a reactor, the only other moderator available to them - heavy water - was now in critically short supply. Thus, according to the Legend, a functioning reactor leading to a critical mass supply of "element 94" was not feasible to them in the projected span of the war.

But let us, for a moment, assume that the Allied commando raid had not taken place. The German failures with graphite moderated reactors were already a matter of record, and it was obvious to them that there were significant technological and engineering hurdles to be surmounted before a reactor came into production. On the other hand, the Germans already had the necessary technology to enrich U235 for a bomb, and thus uranium enrichment constituted the best, most direct, and technologically feasible route to the acquisition of a bomb within the expected span of the war for the Germans. More on that technology in a moment.

One now has to deal with yet another component of the Allied Legend. American progress in the plutonium bomb, from the moment Fermi successfully completed and tested a functioning reactor in the squash court at the University of Chicago, appeared to be running fairly smoothly, until fairly late in the war, when it was discovered that in order to make a bomb from plutonium, the critical mass would have to be assembled much faster than any existing Allied fuse technologies could accomplish. Moreover, there was so little margin of error, since the fuses in an implosion device would have to fire as close to simultaneously as possible, that Allied engineers began to despair of making a plutonium bomb work.

Thus one is confronted with a rather interesting scientific picture, one directly in contradiction to the traditional history of the bomb. If the Germans indeed had a successful and large scale uranium enrichment project running ca. 1941-1944, and if their bomb project was devoted almost exclusively on acquiring a uranium atom bomb, and if at the same time Allied engineers were coming to realize the problems inherent in plutonium bomb design, then this means, in one respect at least, that the Germans have not wasted time or effort" on what is admittedly a more difficult task, namely, the plutonium bomb. As we shall see in the next chapter, this fact gives rise to serious doubts about the state of "success" in the Manhattan Project in late 1944 and early 1945.

So what were the actual technologies available to Nazi Germany for isotope enrichment and separation, and how did it compare to similar technologies employed at Oak Ridge for efficiency and output?

Difficult as it seems to accept, the fact of the matter is that Nazi Germany had "at least five, and possibly as many as seven, serious isotope separation development programs underway."<sup>16</sup> One of these, an "isotope sluice" developed by Drs. **Bagge** and **Korsching**, two of the scientists interred at Farm Hall, was brought to such a state of efficiency by mid-1944 that a single pass of uranium through it would enrich it to four times that produced by a single pass through the gaseous diffusion gates at Oak Ridge!<sup>17</sup>



*Dr. Erich Bagge*

16 Hydrick, *op. cit.*, p. 25. 17 *Ibid.*

Contrast this with the end-of-war difficulties being faced by the Manhattan Project. Even with the enormous gaseous diffusion plant at Oak Ridge, stocks of fissionable uranium were still woefully short of critical mass requirements as late as March 1945. Passes through the Oak Ridge facility would enrich uranium from approximately a 0.7 percent concentration in around 10-12 percent, and thus the decision was taken to use the Oak Ridge production as feedstock for Earnest O. Lawrence's far more efficient and effective "beta calutrons," which were essentially a cyclotron with separation tanks, using electromagnetic means to enrich and separate isotope via mass spectrography.<sup>18</sup>



*Dr. Horst Korsching*

Consequently, one may assume that if a similar quantity of Bagge and Korsching's "isotope sluices" were used en masse, the result would have been a more rapid build-up of enriched uranium feedstock. Similarly, the more efficient German technology may also have allowed for relatively smaller separation facilities.

Good as it was, however, the isotope sluice was not Germany's most efficient or technologically advanced means of uranium enrichment. This was the centrifuge, and its progeny - designed by nuclear chemist **Paul Hartek** - the ultracentrifuge.<sup>19</sup> American engineers, of course, knew of this possibility, but there was a significant drawback they had to face: the highly corrosive uranium gases used in this technology made it unfeasible to rely on centrifuges as a means of enrichment. On the German side, however, this was a solved problem. A special alloy called Bondur was developed precisely for use in centrifuges.<sup>20</sup> But even centrifuge technology was not, however, the best available method the Germans had.

18 Hydrick, *op. cit.*, p. 25.

19 The same technology was captured by the Soviet Union and further perfected in its own bomb program. On the post-war German side, such ultra-centrifuges were provided by the Siemens company and other German firms first to South Africa in its own bomb program (q.v. Rogers and Cervenka,

The Nuclear Axis: West Germany and South Africa, pp. 299-310). In other words, the technology is not only originally German, but is advanced enough to be employed today. It should be noted that, as of the mid-1970s, several of the Germans involved in the corporate development of centrifuge enrichment facilities for the Federal Republic (West Germany) had ties to the third Reich's bomb project, among them Prof. Karl Winnacker, a former member of the I.G. Farben board (p. 300).

20 Hydrick, op. cit., p. 25.



*Dr. Paul Harteck*

Baron **Manfred von Ardenne**, a rich eccentric and self-taught nuclear physicist and inventor, and his close associate of physicist **Fritz Houtermanns**, both correctly calculated the critical mass for a U235 atom bomb in 1941, and with funds from Dr. Ing. Ohnesorge's money-rich Deutsche Reichspost, constructed a huge underground laboratory in his baronial manor in Lichterfelde, outside eastern Berlin.

This laboratory included a 2,000,000 volt electrostatic generator and the only other cyclotron known to exist in the Third Reich besides that of the Curies in France. It is the only cyclotron acknowledged by the post-war Allied Legend.<sup>21</sup>

21 Hydrick, p. 26.

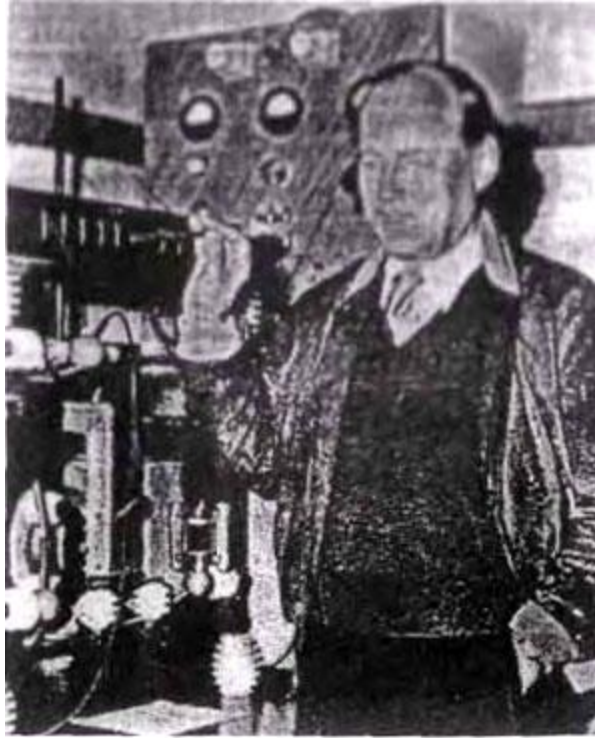

*Baron Manfred von Ardenne*

At this juncture it is necessary to pause to examine the German bomb program more closely, for we now have evidence of at least three different, and seemingly separate, technological efforts:

(1) The Heisenberg-Army program, centered around Heisenberg himself and various associates at the Kaiser Wilhelm and Max Planck institutes, a purely "small laboratory" effort concentrating, or rather, dithering and dabbling in the construction of a reactor. This is the "program" the Allied Legend focuses on, and the one most people think of when they think of the German atom bomb effort. It is the program deliberately inculcated by that Legend as proof of German nuclear incompetence and bungling;<sup>22</sup>

(2) The I.G. Farben "Buna plant" at Auschwitz, whose relationship to the other programs, and to the SS, is not entirely clear; It should be noted again, however, that the German Army's Ordnance Bureau was in possession of essentially correct estimations of the critical mass for a uranium bomb in early 1942, and that Heisenberg himself after the war suddenly reassumed his commanding position by detailing the construction of the Hiroshima bomb along essentially correct principles, and allegedly from information gleaned only from the BBC!

(3) The Bagge-Korsching-von Ardenne-Houtermanns circle, developing an array of advanced separation technologies, and apparently, via von Ardenne, tied somehow to, of all things, the German postal service!

Why the Reichspost? For one thing, it afforded an effective cover for the program, which, like its American counterpart, appears to have been compartmentalized under a number of government agencies, many having no plausible connection with a large secret weapons research effort. Secondly, and more significantly, the Reichspost was awash with money, and could therefore have provided some of the massive funding necessary to the project, a true "black budget" operation in every sense. And finally, the head of the Reichspost was, perhaps not coincidentally, an engineer: Dr. Ing. Ohnesorge. It is, from the German point of view, a logical choice. Even his last name, "Ohnesorge", meaning "without sorrow or regret", is an ironic twist to the story.

What was the method of separation and enrichment developed by von Ardenne and Houtermanns? Very simply, it was the cyclotron itself. Von Ardenne had invented a modification of the cyclotron - electromagnetic separation tanks - very similar to Ernest O. Lawrence's "beta calutrons" in the United States. It is to be noted, however, that von Ardenne had completed his modifications in April of 1942, whereas General Groves in the Manhattan Project would not have Lawrence's beta calutron at Oak Ridge for fully a year and a half after that!<sup>23</sup>

"In addition, the ion plasma source Ardenne had designed for his isotope separator to sublime the uranium compound was far superior to that provided for the calutrons." So efficient, in fact, was Von Ardenne's version as a source for emitting particle rays, that to this day it is known as "the Ardenne source."<sup>24</sup>

Von Ardenne himself is a mysterious figure, for after the war he was one of the few German scientists to deliberately opt to cooperate with the Soviet Union rather than the Western Allies. His contribution to the Soviet acquisition of the atomic bomb in 1949 was to earn him the "Stalin Prize" in 1955, the Soviet equivalent to the Nobel Prize. He was the only non-Russian and non-Soviet ever to win the prize.<sup>25</sup>

23 Hydrick, *op. cit.*, p. 26.

24 Hydrick, *op. cit.*, p. 27.

25 Henshall, *op. cit.*, p. 156.

In any case, Von Ardenne's work, plus that of the other German scientists working on separation and enrichment - Bagge, Korsching, Harteck and Houtermanns - indicates one thing: that there was a sound and solid basis in Allied wartime estimations of German progress and capabilities, for they were, in mid-1942, running a dead heat with the Manhattan Project, and were not "far behind" as the post-war Allied Legend would subsequently have us believe.

So what is the likely scenario, as it has emerged thus far? What conclusions may be drawn?

(1) There were several German bomb and enrichment projects, compartmentalized to maintain security, perhaps being coordinated by some as yet or hitherto unknown entity. In any case, it appears that one such serious program was at least nominally being coordinated by the Deutsche Reichspost under its chief, Dr. Ing. Wilhelm Ohnesorge;

(2) The most significant enrichment and separation projects were not being conducted by Heisenberg or his circle, or for that matter, by any of the more "high profile" German scientists, save perhaps Harteck and Diebner. This suggests that perhaps the more famous scientists were being used as "fronts" and being kept out of the loop of the most serious and significant technological achievements as a matter of security. Had they been involved in such efforts and then subsequently kidnapped or assassinated by the Allies - a thought that certainly occurred to the OSS<sup>26</sup> - then the German program would have been severely crippled and exposed;

(3) At least three German technologies were arguably more efficient and technologically advanced than their American counterparts:

- (a) Bagge and Korsching's "isotope sluice";
- (b) Harteck's centrifuges and ultra-centrifuges;
- (c) Von Ardenne's modified cyclotrons, the "Ardenne source";

(4) At least one known facility was large enough in terms of its physical size, labor requirements, and electrical consumption, to have conceivably been used as a large separation facility, the [I.G. Farben](#) "Buna plant" at Auschwitz. The case is strong because:

- (a) No Buna was ever produced there in spite of thousands of scientists, technicians, engineers, contract and slave laborers working there;
- (b) The site was close to the uranium ore fields of the Czech and German Sudetenland, being located in Polish Silesia;
- (c) The site was close to plentiful water supplies, also needed in isotope enrichment;
- (d) It was close to rail and road networks;
- (e) It was close to plentiful (slave) labor;
- (f) And finally -though not yet discussed - it was close to several large underground secret weapons production and research facilities in lower Silesia, and was close to one of the two alleged test sites of German atom bomb tests during the war;

(5) it may reasonably be assumed, in addition to the "Buna factory", that the Germans constructed smaller facilities in the area for separation and enrichment of isotope, using the Buna plant's production as feedstock for these other facilities.<sup>27</sup>

26 Powers, *op. cit.*, pp. 379-382. Samuel Goudsmit was at one point being considered as a member of the team that would attempt to kidnap or assassinate Heisenberg.



27 Powers, op. cit., p. 74. Powers also mentions another problematical fact concerning the Clusius-Dickel method of thermal diffusion, that we will encounter in chapter 7: "One pound of U-235 was not a daunting figure, and Frisch calculated that 1,000,000 Clusius-Dickel tubes for thermal diffusion of uranium isotopes could produce it in a matter of weeks. Such a large industrial effort would not be cheap, but the two men concluded, 'Even if this plant costs as much as a battleship, it would be worth having.'"

To round out this unpleasant picture, one must also mention two further interesting facts: **Von Ardenne's** close associate and theoretical mentor, Dr. **Fritz Houtermanns'** specialty was thermonuclear fusion, indeed as an astrophysicist, he had staked his claim to fame in physics by describing precisely the type of nuclear process at work in stars. Interestingly enough, there does exist, from 1938, an Austrian patent for a device known as a "Molecular Bomb," a bomb that upon examination is an early version of a hydrogen bomb. Atomic bombs, of course, supply the necessary heat to get hydrogen atoms to collide and produce the much more enormous and terrible energies of thermonuclear hydrogen fusion bombs.

Secondly, it may now clearly be seen why, of all the German scientists working on the atom bomb, that **Manfred Von Ardenne** was the one nuclear scientist that Adolf Hitler most often went personally to visit.<sup>28</sup> In any case, all the evidence points to the conclusion that there was a large, very well-funded, and very secret German isotope enrichment program during the war, a program successfully disguised during the war by the Nazis, and covered-up after war by the Allied Legend. But this too raises its own questions. How close was that program to acquiring sufficient stocks of weapons grade uranium to make a bomb (or bombs). And secondly, why did the Allies after the war go to such stupendous lengths to cover it up?

28 Hydrick, op. cit., p. 29. Rose notes that Von Ardenne had written him and stated that he had never tried to persuade the Nazis to develop his process and employ it in large quantities. He then notes that the Siemens company did not develop it (Rose, op. cit., p. 140, n. 38). This would appear to be pure obfuscation on Von Ardenne's part, for it was not Siemens, but I.G. Farben, that had developed the processes and employed them in large amounts at Auschwitz.

As a final note to this chapter, and a tantalizing indication of further mysteries that will be investigated subsequently in this work, there is a report, declassified by the National Security Agency only in 1978; the report is apparently a decoded intercept from the Japanese embassy in Stockholm to Tokyo. It is entitled simply "*Reports on the Atom-Splitting Bomb.*"

It is best to cite its amazing contents in their entirety, with their original breaks where they occurred in the text for transmission:

This bomb is revolutionary in its results, and it will completely upset all ordinary precepts of warfare hitherto established. I am sending you, in one group, all those reports on what is called the atom-splitting bomb:

It is a fact that in June of 1943 the German Army tried out an utterly new type of weapon against the Russians at a location 150 kilometers southeast of Kursk. Although it was the entire 19th Infantry Regiment of the Russians which was thus attacked, only a few bombs (each round up to 5 kilograms) sufficed to utterly wipe them out to the last man.

Part 2. The following is according to a statement by Lieutenant-Colonel UE(?) I KENJI, advisor to the attaché in Hungary and formerly (?on duty?) in this country, who by chance saw the actual scene immediately after the above took place:

"All the men and the horses (?within the area of?) the explosion of the shells were charred black and even their ammunition had all been detonated. "

Moreover, it is a fact that the same type of war material was tried out in the Crimea, too. At that time the Russians claimed that this was poison-gas, and protested that if Germany were ever again to use it, Russia, too, would use poison-gas.

Part 3. There is also the fact that recently in London - in the period between October and the 15th of November - the loss of life and the damage to business buildings through fires of unknown origin was great. It is clear, judging especially by the articles about a new weapon of this type, which have appeared from time to time recently in British and American magazines - that even our enemy has already begun to study this type.

To generalize on the basis of all these reports: I am convinced that the most important technical advance in the present great war is in the realization of the atom-splitting bomb. Therefore, the central authorities are planning, through research on this type of weapon, to speed up the matter of rendering the weapon practical. And for my part, I am convinced of the necessity for taking urgent steps to effect this end.

Part 4. The following are the facts I have learned regarding its technical data:

Recently the British authorities warned their people of the possibility that they might undergo attacks by German atom-splitting bombs. The American military authorities have likewise warned that the American east coast might be the area chosen for a blind attack by some sort of flying bomb. It was called the German V-3. To be specific, this device is based on the principle of the explosion of the nuclei of the atoms in heavy hydrogen derived from heavy water. (Germany has a large plant (?for this?) in the vicinity of Rjukan, Norway, which has from time to time been bombed by English planes.)

Naturally, there have been plenty of examples even before this of successful attempts at smashing individual atoms. However, as far as the demonstration of any practical results is concerned, they seem not to have been able to split large numbers of atoms in a single group. That is, they require for the splitting of each single atom a force that will disintegrate the electron orbit.

Part 5. On the other hand, the stuff that the Germans are using has, apparently, a very much greater specific gravity than anything heretofore used. In this connection, allusions have been made to SIRIUS and *stars of the "White Dwarf" group*. (Their specific gravity is (?6?) 1 thousand, and the weight of one cubic inch is 1 ton.)

In general, atoms cannot be compressed into the nuclear density. However, the terrific pressures and extremes of temperature in the "White Dwarfs" cause the bursting of the atoms and *A-GENSHI HAKAI DAN*. That is, a bomb deriving its force from the release of atomic energy.

Part 6. There are, moreover, radiations from the exterior of these stars composed of what is left of the atoms which are only the nuclei, very small in volume.

According to the English newspaper accounts, the German atom-splitting device is the NEUMAN disintegrator. Enormous energy is directed into the central part of the atom and this generates at atomic pressure of several tons of thousands of tons (sic) per square inch. This device can split the relatively unstable atoms of such elements as uranium. Moreover, it brings into being a store of explosive atomic energy.

The end of this amazing intercept then reads "Inter 12 Dec 44 (1,2) Japanese; Rec'd 12 Dec 44; Trans 14 Dec 44 (3020-B)," apparently references to when the message was intercepted by American intelligence, its original language (Japanese), when the message was received, when it was translated (14 Dec 44), and by whom (3020-B).<sup>29</sup>

29 Edgar Mayer and Thomas Mehner, *Hitler und die „Bombe"* (Rottenburg: Kopp Verlag, 2002), pp. 110-114, emphasis added, citing "Stockholm to Tokyo, No. 232.9 December 1944 (War Department), National Archives, RG 457, SRA 14628-32, declassified October 1, 1978.

The date of this document - after the lest allegedly seen by **Hans Zinsser** and two days before the beginning of the Battle of the Bulge - must have set off alarm bells in the offices of Allied Intelligence personnel both during and after the war. While it is certainly clear that the Japanese attaché in Stockholm seems to be somewhat confused about the nature of nuclear fission, a number of startling things stand out in the document:

(1) The Germans were, according to the report, using weapons of mass destruction of some type on the Eastern Front, but had apparently for some reason refrained from using them on the Western Allies;

(a) The areas specifically mentioned were Kursk, in the approximate location of the southern pincer of the German offensive, which took place in July, and not June, of 1943, and the Crimean peninsula;

(b) The time mentioned was 1943, though since the only major action to have occurred in the Crimea was in 1942 with the massive German artillery bombardment, one must also conclude that the time frame stretched back into 1942; (At this juncture is it worth pausing to consider briefly the German siege of the Russian fortress of Sevastopol, scene of the most colossal artillery bombardment of the war, as it bears directly on the interpretation of this intercept.

The siege was led by Colonel-General (later Field Marshal) **Erich Von Manstein's** 11th Army. Von Manstein assembled 1,300 artillery pieces - the largest concentration of heavy and super-heavy artillery deployed by any Power during the war - and pounded Sevastopol with this mighty arsenal twenty-four hours a day for five days. These were no ordinary heavy field pieces.

Two mortar regiments - the 1st Heavy Mortar Regiment and the 70th Mortar Regiment - as well as the 1st and 4th Mortar Battalions, had been concentrated in front of the fortress under the special command of Colonel Nieman - altogether 21 batteries with 576 barrels, including the batteries of the 1st Heavy Mortar regiment with the 11- and 12 1/2 inch high explosive and incendiary oil shells...

Even these monsters were not the largest pieces deployed at Sevastopol. Several of the 16 1/2 inch "Big Bertha" Krupp cannon and their old Austrian Skoda counterparts were massed against the Russian positions, along with the even more colossal "Karl" and "Thor" mortars, gigantic self-propelled 24 inch mortars firing shells that weighed over two tons.

But even "Karl" was not quite the last word in gunnery. That last word was stationed at Bakhchisary, in the "Palace of Gardens" of the ancient residence of the Tartar Khans, and was called "Dora," or occasionally "Heavy Gustav." It was the heaviest gun of the last war. Its caliber was 31 1/2 inches. Sixty railway carriages were needed to transport the parts of the monster. Its 107-foot barrel ejected high-explosive projectiles of 4800 kg -i.e., nearly five tons -over a distance of 29 miles. Or it could hurl even heavier armour-piercing missiles, weighing seven tons, at targets nearly 24 miles away. The missile together with its cartridge measured nearly twenty-six feet in length. Erect that would be about (the) height of a two-storey house....

These data are sufficient to show that here the conventional gun had been enlarged to gigantic, almost super-dimensional scale - indeed, to a point where one might question the economic return obtained from such a weapon. Yet one single round from "Dora" destroyed an ammunition dump in Severnaya Bay at Sevastopol although it was situated 100 feet below ground.<sup>30</sup>

**30 Paul Carrell, Hitler Moves East, 1941-1943 (Ballantine Books, 1971) pp. 501-503, emphasis added. So horrendous was the bombardment from this massed heavy and super-heavy artillery that the German General Staff estimated that over 500 rounds fell on Russian positions per second during the five days' artillery and aerial bombardment, a massive expenditure of ammunition. The rain of steel on the Russian positions pulverized Russian morale and was often so thunderous that eardrums burst. At the end of the battle, the city and environs of Sevastopol were ruined, two entire Soviet armies had been obliterated, and over 90,000 prisoners were taken, (pp. 501-502, 511)**

Why are these details significant? First, note the reference to "incendiary oil shells." These shells are the indication that unusual weaponry was deployed by the Germans at Sevastopol and delivered through conventional - though quite large - artillery pieces. The German Army did possess such shells and deployed the frequently and with no little effectiveness on the Eastern Front.

But might there have been an even more fearsome weapon? In subsequent chapters we will present evidence that the Germans indeed developed an early version of a modern "fuel-air" bomb, a conventional explosive with the explosive power of a tactical nuclear weapon. Given the great weight of such projectiles, and the German lack of sufficient heavy-lift aircraft to deliver them, it is possible if not likely that super-heavy artillery was used to deploy them. This would also explain another curiosity in the Japanese military attaché's statement: the Germans apparently did not deploy weapons of mass destruction against cities, but only against military targets that would have been within the range of such weapons. We may now resume with the analysis of the Japanese statement.

**(2)** The Germans may have been seriously pursuing the hydrogen bomb, since reactions of the nuclei of heavy water atoms - containing deuterium and tritium - are essential in thermonuclear fusion reactions, a point highlighted by the Japanese delegate (though he confuses these reactions with fission reactions of atom bombs), and corroborated by Fritz Houtermans' pre-war work in the thermonuclear fusion process at work in stars;

**(3)** The enormous temperatures of atom bombs are used as detonators in conventional hydrogen bombs;

**(4)** In desperation the Russians appear to have been ready to resort to the use of poison gas against the Germans if they did not "cease and desist";

**(5)** The Russians believe the weapons to have been "poison gas" of some sort, either a cover story put out by the Russians, or a result of field reports being made by Russian soldiers who were ignorant of the type of weapon deployed against them;<sup>31</sup> and finally, and most sensationally,

**(6)** According to the Japanese cable, the Germans appeared to have gained their specialized knowledge via some connection to the star system of Sirius and that knowledge involved some exotic form of very dense matter, a statement that strains credulity even today.

It is this last point that directs our attention to the most fantastic and arcane recesses of wartime German secret weapons research, for if the allegation has even a partial basis in truth, then it indicates that at some highly secret level, physics, and the esoteric, were being pursued by the Nazi regime in some very extraordinary ways.<sup>32</sup> In this regard it is important to note that the extreme density of the material described by the Japanese envoy resembles nothing so much as a construct of modern post-war theoretical physics called "dark matter". In all likelihood his report greatly overestimates the mass of this material - if it existed at all - but nonetheless it is crucial to observe that it is material far beyond the ordinary density of matter.

31 The detail of "charred bodies" and exploded ammunition certainly point to non-conventional weaponry. A fuel-air device would at least account for the charring. The tremendous heat produced by such a bomb could also conceivably detonate ammunition. Likewise, radioactive burns with its characteristic blistering effects might well have been misunderstood by Russian field soldiers and officers, who would most likely not have been familiar with nuclear energy, as the effects of poison gas.

32 To anyone familiar with the wealth of material on alternative research into the Giza compound in Egypt, the reference to Sirius will immediately conjure images of Egyptian religion, its preoccupation with death, with the Osiris myth, and to the Sirian star system.

Strangely, the German-Sirian connection pops up again, long after the war, in an unusual context. In my previous book, [The Giza Death Star Deployed](#), I mentioned the research of **Robert Temple** into the mysterious [African Dogon tribe](#), a tribe of primitive peoples that nonetheless appears to have preserved an accurate knowledge of the Sirian star system for many generations, from a period long before modern astronomy knew anything about it. In that book, I noted that

Temple also alleges serious Soviet **KGB** and American **CIA** and **NSA** interest in his book.... An odd mention, perhaps significant in the light of our later discussion of possible German involvement in scalar physics research during World War Two and after, is Temple's allegation that Baron **Jesco von Puttkamer** wrote him a denunciatory letter on NASA stationery, only later to retract that, stating that it did not represent an official NASA position. Temple believes that Puttkamer was one of the Germans brought to the USA during the notorious [Operation Paper Clip](#) in the days immediately following the Nazi surrender (pp. 9-10).<sup>33</sup>

33 Joseph P. Farrell, *The Giza Death Star Deployed* (Kempton, Illinois: Adventures Unlimited Press, 2003, p. 81).

As I then go on to observe in that book, Karl Jesco von Puttkamer was no ordinary German, being a member of Adolf Hitler's military staff throughout the war as his naval adjutant to staff, beginning the war with the rank of captain and ending with the rank of admiral. Puttkamer was subsequently employed by NASA.

So the investigation of the German atom bomb, via this recently declassified Japanese cable, has already led us far afield, into a realm of frightening potentialities, into a world of fuel-air bombs, gigantic artillery delivery systems, super-dense matter, the hydrogen bomb, and what seems to be a curious blend of mystical esotericism and Egyptology, and physics.

Was there a German bomb?

In the above context, the question seems almost plain and ordinary. If so, then given the extraordinary reports that leaked out from time to time from the Eastern Front, what other even more secret research lay behind their atom bomb projects, for evidently such research there was?

But exotic super dense matter or not, according to some versions of the Allied Legend, the Germans never had enough fissile weapons grade uranium to begin with. We will now investigate the problem of the "missing uranium."



"Heavy Gustav " or "Dora " the 31 1/2 Monster that Hurlled Five and Seven Ton Projectiles Against Sevastopol: Were they Conventional Rounds, or Fuel-Air Bombs?



A British Sergeant inspects one of "Gustav's" Seven Ton Arrows Piercing Projectiles.

[Back to Contents](#)

### Chapter 3: **U<sup>234</sup>, U<sup>235</sup>, AND THE STRANGE CASE OF THE MISSING URANIUM 53**

"The traditional history denies, however, that the uranium on board U-234 was enriched and therefore easily usable in an atomic bomb. The accepted theory asserts there is no evidence that the uranium stocks of U-234 were transferred into the Manhattan Project... And the traditional history asserts that the bomb components on board (the) U-234 arrived too late to be included in the atomic bombs that were dropped on Japan.

"The documentation indicates quite differently on all accounts. "

**Carter P. Hydrick**

*Critical Mass: The Real Story of the Atomic Bomb and the Birth of the Nuclear Age.*<sup>1</sup>

In December of 1944, an unhappy report is made to some unhappy people:

"A study of the shipment of (bomb grade uranium) for the past three months shows the following.....: At present rate we will have 10 kilos about February 7 and 15 kilos about May 1."<sup>2</sup>

This was bad news indeed, for a uranium based atom bomb required between 10-100 kilograms by the earliest estimates (ca. 1942), and, by the time this memo was written, about 50 kilos, the more accurate calculation of critical mass needed to make an atom bomb from uranium.

One may imagine the consternation this memo must have caused at headquarters. The was, perhaps, a considerable degree of yelling and screaming and finger pointing and other histrionics, interlarded with desperate orders to re-double efforts amid the fire- tinged skies of the war's Wagnerian Gotterdammerung.

<sup>1</sup> Carter Hydrick, *Critical Mass: the Real Story of the Atomic Bomb and the Birth of the Nuclear Age*, Internet published manuscript, <http://saba.fateback.com/criticalmass/begin.html>, 1998, p. 6.

<sup>2</sup> *Ibid.*, p. 11.

The problem, however, is that the memo is not German at all. It originates within the Manhattan Project on December 28, 1944, from **Eric Jette**, the chief metallurgist at Los Alamos. One may imagine the desperation it must have triggered, however, since the Manhattan Project had consumed two billion dollars all in the pursuit of plutonium and uranium atom bombs. By this time it was of course apparent that there were significant and seemingly insurmountable problems in designing a plutonium bomb, for the fuses available to the Allies were simply far too slow to achieve the uniform compression of a plutonium core within the very short span of time needed to initiate uncontrolled nuclear fission.

That left the uranium bomb as the more immediately feasible alternative - as the Germans had discovered years earlier - to the acquisition of a functioning weapon within the projected span of the war. Yet, after a veritable hemorrhage of dollars in pursuit of the latter objective, the Manhattan Project was far short of the necessary critical mass for a uranium bomb. And with the inevitability of an invasion of Japan looming, the pressure on General Leslie Groves to produce results was immense.

The lack of a sufficient stockpile, after years of concentrated all-out effort, was in part explainable, for two years earlier Fermi had been successful in construction of the first functioning atomic reactor. That success had spurred the American project to commit more seriously to the pursuit of a plutonium bomb. Accordingly, some of the precious and scarce refined and enriched uranium 235 coming out of Oak Ridge and Lawrence's *beta calutrons* was being siphoned off as feedstock for enrichment and transmutation into plutonium in the breeder reactors constructed at Hanford, Washington for the purpose.

Thus, some of the fissionable uranium stockpile had been deliberately diverted for plutonium production.<sup>3</sup> The decision was a logical one and the Manhattan Project decision-makers cannot be faulted to taking it. The reason is simple. Pound for weapons grade pound, a pound of plutonium will produce more bombs than a pound of uranium. It thus made economic sense to convert enriched uranium to plutonium, for more bombs would be possible with the same amount of material.

<sup>3</sup> Hydrick, *op. cit.*, p. 12.

But in December of 1944, having pursued both options, General Leslie Groves now stood on the verge of losing both gambles. And let us not forget what had just happened in Europe to sour the mood of "those in the know" in the United States even further. There, six months after the Allied landings in Normandy and the headlong dash across France, Allied armies had stalled on the borders of the Reich. Allied intelligence analysts confidently reassured the generals that no further significant German military offensive was possible, and their optimism was reflected in the general mood of the citizenry in France, Britain, and the United States.

The mood was brutally shattered when, on December 16, 1944, the German Army and Luftwaffe mounted one last, desperate offensive with secretly husbanded reserves in the Ardennes forest, scene of their 1940 triumph against France. Within a matter of hours, the offensive had broken through American lines, surrounded, captured, or otherwise decimated the entire 116th American infantry division, and days later, surrounded the 101st Airborne division at Bastogne, and appeared well on the way to crossing the Meuse River at Namur. On December 28, 1944, when the memo was written, the German offensive had been stalled, but not stopped.

For the Allied officers privy to intelligence reports and "in the loop" on the Manhattan Project, the offensive was possibly seen as confirmation of their worst fears: the Germans were close to a bomb, and were trying to buy time. The horrible thought in the back of every Allied scientist's and engineer's head must have been that after all the Allied military successes of the previous years, the race for the bomb could still be won by the Germans.

And if they were able to produce enough of them to put unbearable pressure on any one of the Western Allies, the outcome of the war itself was still in doubt. If, for example, the Germans had a-bombed British and French cities, it is unlikely that a continuance of the would have been politically feasible for Churchill's wartime coalition government. In all likelihood it would have collapsed. A similar result would have likely occurred in France. And without British and French bases available for supply and forward deployment, the American military situation on the continent would have become untenable, if not disastrous.

In any case, word of the Manhattan Project's difficulties apparently leaked in the Washington DC political community, for United States Senator **James F. Byrnes** got in on the act, writing a memorandum to President Franklin D. Roosevelt, and confirming that the Manhattan Project was perceived - at least by some in the know - as being in danger of failure:

SECRET March 3, 1945  
MEMORANDUM FOR THE PRESIDENT

FROM: JAMES F. BYRNES

I understand that the expenditures for the Manhattan project are approaching 2 billion dollars with no definite assurance yet of production.

We have succeeded to date in obtaining the cooperation of Congressional Committees in secret meetings. Perhaps we can continue to do so while the war lasts.

However, if the project proves a failure, it will be subjected to relentless criticism.<sup>4</sup>

**4 Memorandum of US Senator James F. Byrnes to President Franklin D. Roosevelt, March 3, 1945, cited in Harald Fath, Geheime Kommandosache -S III Jonastal und die Siegeswaffenproduktion: Weitere spurensuche nach Thuringens Manhattan Project (Schleusingen: Amun Verlag, 2000), p. 41.**

Senator Brynes' memorandum highlights the real problem in the Manhattan Project, and the real, though certainly not publicly known, military situation of the Allies ca. late 1944 and early 1945: that in spite of tremendous conventional military success against the Third Reich, the Western Allies and Soviet Russia could conceivably still be forced to a "draw" if Germany deployed and used atom bombs in sufficient numbers to affect the political situation of the Western Allies.

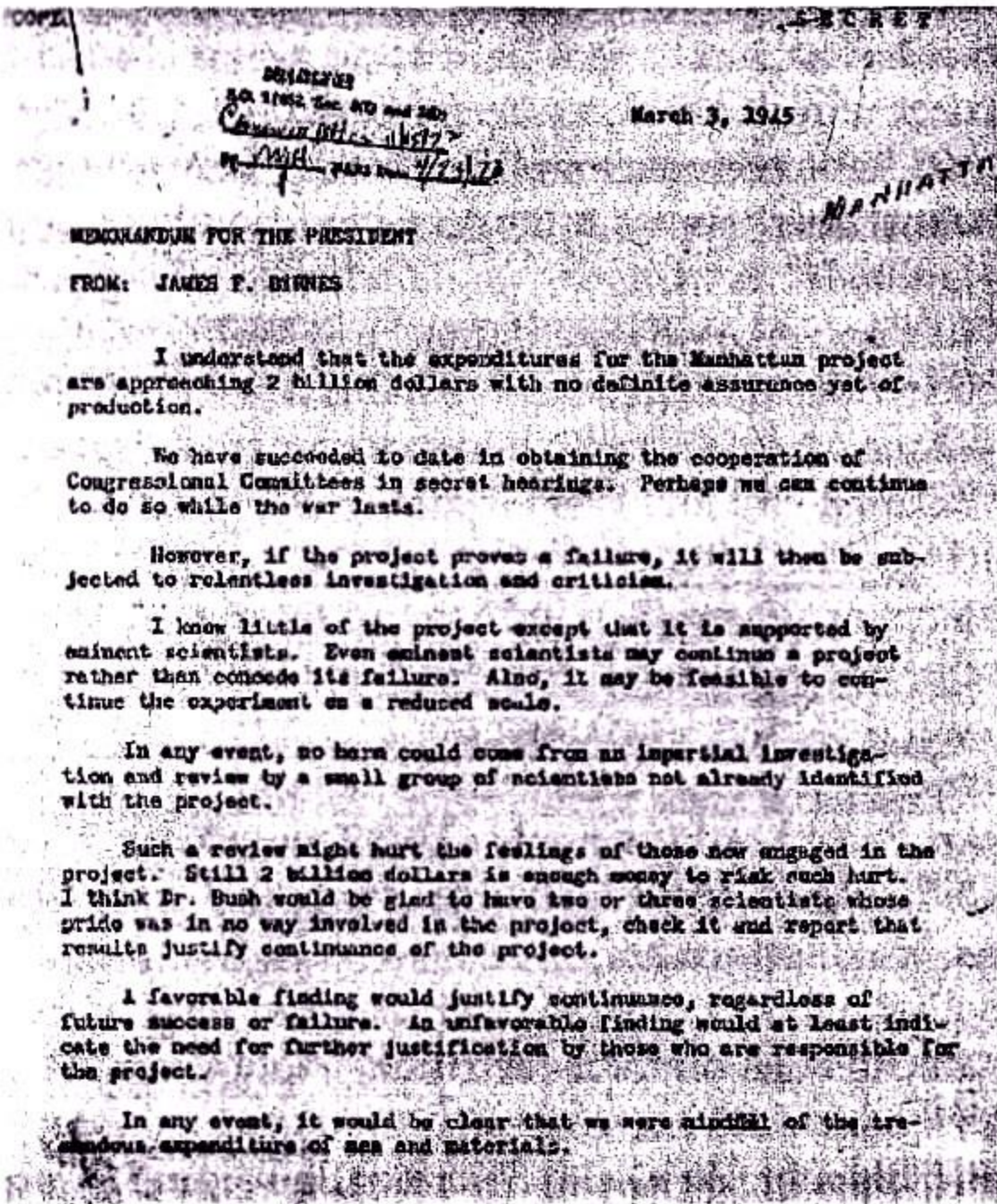

Senator Byrnes' March 1945 Memorandum to President Roosevelt

With its stockpile of enriched uranium already depleted by the decision to develop more plutonium for a bomb (which as it turned out was undetonatable with existing British and American fuse technology anyway) and far below that needed for a uranium-based atom bomb, "the entire enterprise appeared destined for defeat."<sup>5</sup> Not only defeat, but for "those in the know" in late 1944 and early 1945, the possibility was one of ignominious defeat and horrible carnage.

5 Hydrick, op. cit, p. 13.

If the stocks of weapons grade uranium ca. late 1944 - early 1945 were about half of what they needed to be after two years of research and production, and if this in turn was the cause of Senator Byrnes' concern,

- How then did the Manhattan Project acquire the large remaining amount of uranium 235 needed in the few months from March to the dropping of the Little Boy bomb on Hiroshima in August, only five months away?
- How did it accomplish this feat, if in fact after some three years of production it had only produced less than half of the needed supply of critical mass weapons grade uranium?



- Where did its missing uranium 235 come from?
- And how did it solve the pressing problem of the fuses for a plutonium bomb?

Of course the answer is that if the Manhattan Project was incapable of producing enough enriched uranium in that short amount of time - months rather than years - then its stocks had to have been supplemented from external sources, and there is only one viable place with the necessary technology to enrich uranium on that scale, as seen in the previous chapter. That source was **Nazi Germany**. But the *Manhattan Project* is not the only atom bomb project with some missing uranium.

Germany too appears to have suffered the "missing uranium syndrome" in the final days prior to and immediately after the end of the war. But the problem in Germany's case is that the missing uranium is not a few tens of kilos, but several hundred tons. At this juncture, it is worth citing **Carter Hydrick's** excellent research at length, in order to exhibit the full ramifications of this problem:

From June of 1940 to the end of the war, Germany seized 3,500 tons of uranium compounds from Belgium - almost three times the amount Groves had purchased.... and stored it in salt mines in Strassfurt, Germany. Groves brags that on 17 April, 1945, as the war was winding down, Alsos recovered some 1,100 tons of uranium ore from Strassfurt and an additional 31 tons in Toulouse, France ..... And he claims that the amount recovered was all that Germany had ever held, asserting, therefore, that Germany had never had enough raw material to process the uranium either for a plutonium reactor pile or through magnetic separation techniques.

Obviously, if Strassfurt once held 3,500 tons and only 1,130 were recovered, some 2,370 tons of uranium ore was unaccounted for - still twice the amount the Manhattan Project possessed and is assumed to have used throughout its entire wartime effort.... The material has not been accounted for to this day....

As early as the summer of 1941, according to historian **Margaret Gowing**, Germany had already refined 600 tons of uranium to its oxide form, the form required for ionizing the material into a gas, in which form the uranium isotopes could then be magnetically or thermally separated or the oxide could be reduced to a metal for a reactor pile. In fact, Professor **Dr. Riehl**, who was responsible for all uranium throughout Germany during the course of the war, says the figure was actually much higher....

To create either a uranium or plutonium bomb, at some point uranium must be reduced to metal. In the case of plutonium, U238 is metallized; for a uranium bomb, U235 is metallized. Because of uranium's difficult characteristics, however, this metallurgical process is a tricky one. The United States struggled with the problem early and still was not successful reducing uranium to its metallic form in large production quantities until late in 1942. The German technicians, however, by the end of 1940, had already processed 280.6 kilograms into metal, over a quarter of a ton.<sup>6</sup>

<sup>6</sup> Hydrick, *op. cit.*, p. 23, emphasis added.

These observations require some additional commentary.

First, it is to be noted that Nazi Germany, by the best available evidence, was missing approximately two thousand tons of unrefined uranium ore by the war's end. Where did this ore go?

Second, it is clear that Nazi Germany was enriching uranium on a massive scale, having refined 600 tons to oxide form for potential metallization as early as 1940. This would require a large and dedicated effort, with thousands of technicians, and a commensurately large facility or facilities to accomplish the enrichment. The figures, in other words, tend to corroborate the hypothesis outlined in the previous chapter that the I.G. Farben "Buna" factory at Auschwitz was not a Buna factory at all, but a huge uranium enrichment facility. However, the date would imply another such facility, located elsewhere, since the Auschwitz facility did not really begin production until sometime in 1942.

Finally, it also seems clear that the Germans possessed an enormous stock of metallic uranium. But what was the isotope? Was it U238 for further enrichment and separation into U235, was it intended perhaps as feedstock for a reactor to be transmuted into plutonium, or was it already U235, the necessary material for a uranium atom bomb? Given the statements of the Japanese military attaché in Stockholm cited at the end of the previous chapter - that the Germans may have used an atomic or some other weapon of mass destruction on the Eastern Front ca. 1942-43, and given Zinsser's affidavit cited in the first chapter of an atom bomb test in October of 1944, it cannot be conclusively denied that some of this enormous stockpile may also have been U235, the essential component for a bomb.

In any case, these figures strongly suggest that the Germans, ca. 1940-1942 were significantly ahead of the Allies in one very important aspect of atom bomb production: the enrichment of uranium, and therefore, this suggests also that they were demonstrably ahead in the race for an actual functioning atom bomb during this period. But the figures also raise another disturbing question: where did this uranium go?

One answer lies in the mysterious case of a U-boat, the U-234, captured by the Americans in 1945.

---

The case of the U-234 is well-known in literature about the Nazi atom bomb, and of course the Allied Legend is that none of the material on board the U-boat found its way into the American atom bomb project.

None of this could be further from the truth.

The U-234 was a very large mine-laying U-boat that had been adapted as an undersea freighter to carry large cargoes. Consider then the following "cargo manifest" of the U-234's very odd cargo:

- (1) Two Japanese officers <sup>7</sup>
- (2) 80 gold-lined cylinders containing 560 kilograms of uranium oxide <sup>8</sup>
- (3) Several wooden cases or barrels full of "water"
- (4) Infrared proximity fuses
- (5) Dr. Heinz Schlicke, inventor of the fuses

When the U-234 was being loaded with its cargo in Germany for the outward voyage, its radio operator, Wolfgang Hirschfeld, observed the two Japanese officers writing "U235" on the paper wrapping of the cylinders prior to their being loaded into the submarine.<sup>9</sup> Needless to say, this observation has called forth the full range of debunking techniques normally applied by skeptics to UFO sightings: low sun angles, poor lighting, distance was too great to see clearly, etc. etc. This is no surprise, for if Hirschfeld saw what he saw, then the enormous implications were obvious.

The use of gold lined cylinders is explainable by the fact that uranium, a highly corrosive metal, is easily contaminated if it comes into contact with other unstable elements. Gold, whose radioactive shielding properties are as great as lead, is also, unlike lead, a highly pure and stable element, and is therefore the element of choice when storing or shipping highly enriched and pure uranium for long periods of time, such as a voyage.<sup>10</sup> Thus, the uranium oxide on board the U-234 was highly enriched uranium, and most likely, highly enriched U235, the last stage, perhaps, before being reduced to weapons grade or to metallization for a bomb (if it was already in weapons grade purity).

<sup>7</sup> The two officers were Air Force Colonel Genzo Shosi, an engineer, and Navy Captain Hideo Tomonaga. When the captain of the U-234 made known his intentions to surrender the submarine, which was then en route to Japan after the German surrender, the two Japanese officers committed hari-kiri, and were buried at sea with full military honors by the Germans.

<sup>8</sup> Hydrick's comment on the U-234's cargo manifest explains why the U-234 was off limits to the American press following its surrender: "Whoever first read the entry and understood the frightening capabilities and potential purpose of uranium must have been stunned by the entry." (op. cit., p. 7)

<sup>9</sup> Hydrick, op. cit., p. 5.

<sup>10</sup> Ibid., p. 8.

Indeed, if the Japanese officers' labels on the cylinders were accurate, it is likely that it was at the final stage of purity before metallization.

The cargo of the U-234 was so sensitive, in fact, that when the U.S. Navy prepared its own cargo manifest for the German submarine on June 16, 1945, the uranium oxide had entirely disappeared from the list.<sup>11</sup> Significantly, within a week of the appearance of the U.S. Navy's version of the U-234's cargo manifest, Oak Ridge's output of enriched uranium very nearly doubled.<sup>12</sup> This in itself is highly suspect, since as late as March of 1945, as we have already seen, a U.S. Senator is worried about the failure of the Manhattan Project, so much so that he writes President Roosevelt a memorandum on the subject, and of course, we have also already seen that the chief metallurgist of Los Alamos laboratory indicates the stock of fissile U235 is far short of the needed critical mass, and would remain so for several months.

<sup>11</sup> Hydrick, op. cit., p. 9.

<sup>12</sup> Ibid., p. 11

The conclusion is therefore simple, but frightening: the missing uranium used in the Manhattan Project was German, and that means that Nazi Germany's atom bomb project was much further along than the post-war Allied Legend would have us believe.

But what of the other two items in the U-234's strange cargo manifest, the fuses and their inventor, Dr. **Heinz Schlicke**? We have already noted that by late 1944 and early 1945, the American plutonium bomb project had run afoul of some nasty mathematics: the critical mass of a plutonium bomb, "imploded" or compressed by surrounding conventional explosives, would have to be assembled within 1/3000th of a second, otherwise the bomb would fail, and only produce a kind of "atomic fizzling firecracker", a "radiological" bomb producing very little explosion but a great deal of deadly radiation. This was a speed far in excess of the capabilities of conventional wire cabling and the ordinary fuses available to the Allied engineers.

It is known that late in the timetable of events leading to the Trinity test of the plutonium bomb in New Mexico that a design modification was introduced to the implosion device that incorporated "radiation venting channels", allowing radiation from the plutonium core to escape and reflect off the surrounding reflectors as the detonator was fired, within billionths of a second after the beginning of compression. There is no possible way to explain this modification other than by the incorporation of Dr. Schlicke's infrared proximity fuses into the final design of the American bomb, since they enabled the fuses to react and fire at the speed of light.<sup>13</sup>

In support of this historical reconstruction, there is a communication from May 25, 1945 from the chief of Naval Operations, to Portsmouth where the U-234 was brought after its surrender, indicating that Dr. Schlicke, now a prisoner of war, would be accompanied by three naval officers, to secure the fuses and bring them to Washington.<sup>14</sup> There Dr. **Schlicke** was apparently to give a lecture on the fuses under the auspices of a "Mr. Alvarez,"<sup>15</sup> who would appear to be none other than well-known Manhattan Project scientist Dr. **Luis Alvarez**, the very man who, according to the *Allied Legend*, "solved" the fusing problem for the plutonium bomb!<sup>16</sup>

<sup>13</sup> Q.v. Hydrick, *op. cit.*, pp. 46-51, for a detailed discussion of this issue and the historical problems it poses for the Allied Legend.

<sup>14</sup> *Ibid.*, p. 46.

<sup>15</sup> *Ibid.*

<sup>16</sup> As I observed in my previous book, *The Giza Death Star Deployed*, Dr. Luis Alvarez also had some other strange distinctions to his credit, being one of the scientists allegedly involved with the alleged Roswell "UFO" crash, the CIA's subsequent "Robertson Panel" in the 1950s on UFOs and government policy, and subsequent cosmic ray experiments inside the 2nd Pyramid at Giza.

So it would appear that the surrender of the U-234 to the Americans in 1945 solved the Manhattan Project's two biggest outstanding problems: lack of sufficient supplies of weapons grade uranium, and lack of adequate fusing technology to make a plutonium bomb work. And this means that in the final analysis the Allied Legend about the Germans having been "far behind" the Allies in the race for the atom bomb is simply incorrect in the extreme in the best case, or a deliberate lie in the worst. But the fuses raise another frightening specter: What were the Germans developing such highly sophisticated fuses for? Infrared heat-seeking rockets, which they had developed, would be one answer, and of course an implosion device to compress critical mass would be another.

But what about the other missing German uranium mentioned previously? The mission of the U-234 and its precious cargo thus raises certain other questions, and highlights other possibilities in this regard. It is a fact that throughout the war Germany and Japan both conducted long-range exchanges of officers and technology via aircraft and submarine - the exchange of technology being mostly a one-sided affair from Germany to Japan. It is conceivable that many of these voyages - just as with the U-234 - would have included similar transfers of uranium stocks and high technology to Japan. Some of the missing uranium must therefore surely be looked for in the Far East, in the Japanese atom bomb program.<sup>17</sup>

Similarly, during the war both Germany and Italy undertook long-range flights to Japan, the Germans using their special long-range heavy lift transport aircraft such as the Ju-290 for polar flights. It is conceivable that these flights and their Italian counterparts also involved the exchange of officers and technology, if not a small amount of raw material as well. Some of the missing uranium probably also fell into the hands of the Soviets as the Russian armies steamrolled into Eastern Europe and finally into what would become the Soviet "eastern" zone of occupation in Germany.

But why, after traveling under radio silence from Germany, did the U-234 finally surrender its precious uranium, fuses, and "water", when its obvious destination was Japan? This is an intriguing question, and one that unfortunately cannot be answered here except briefly. Again, **Carteer Hydrick's** superb research elaborates one highly probable hypothesis: U-234 was handed over to the US authorities on the orders of none other than Martin Bormann, in a maneuver designed to

secure his and others' freedom after the war, and as part of a deliberate plan to continue Nazism and its agendas and research underground.<sup>18</sup>

17Q.v. chapter 7.

18 Q.v. part two. The allegation that Bormann's action was a component of this plan is my own, and not Hydrick's although Hydrick also clearly suggests a connection. This "Bormann hypothesis" of the events leading up to the U-234's surrender is a major component of Hydrick's work, spanning several pages of meticulous research.

It is thus, on this view, the first visible, and crucial, element of the emerging Operation Paperclip, the transfer of technology amid scientists from the collapsing Third Reich to the United States. There, the German scientists and engineers could, would, and did continue their lines of esoteric research and development of high technology and sophisticated weaponry, with a similar moral and ideological effect on the culture at large as occurred in Nazi Germany.

And finally, of course, as we have already seen, some of the missing uranium ended up in the German atom bomb program itself, enriched, and refined, and probably assembled and tested - if not used - in actual bombs themselves.

[Back to Contents](#)

## Chapter 4

### "MEIN HUT ER HAT DREI ECKEN"; THE TEST SITES

"We still have things that need to be finished, and when they are finished, they will turn the tide "

**Adolph Hitler,**  
March 13, 1945, addressing officers of the German Ninth Army.

#### A. An Unusual Exchange at Nuremberg

At the Nuremberg War Crimes Tribunals after the war, an amazing exchange occurred between former architect cum Nazi minister of armaments, **Albert Speer**, and Mr. **Jackson**, the chief American prosecutor.

JACKSON: Now, I have certain information, which was placed in my hands, of an experiment which was carried out near Auschwitz and I would like to ask you if you heard about it or knew about it.

The purpose of the experiment was to find a quick and complete way of destroying people without the delay and trouble of shooting and gassing and burning, as it had been carried out, and this is the experiment, as I am advised.

A village, a small village was provisionally erected, with temporary structures, and in it approximately 20,000 Jews were put. By means of this newly invented weapon of destruction, these 20,000 people were eradicated almost instantaneously, and in such a way that there was no trace left of them; that is developed, the explosive developed, temperatures of from 400 degrees to 500 degrees centigrade and destroyed them without leaving any trace at all.

Do you know about that experiment?

SPEER: No, and I consider it utterly improbable. If we had had such a weapon under preparation, I should have known about it. But we did not have such a weapon. It is clear that in chemical warfare attempts were made on both sides to carry out research on all the weapons one could think of, because one did not know which party would start chemical warfare first...<sup>1</sup>

<sup>1</sup> Cited in Harald Fath, *Geheime Kommandosache -S III Jonastal und die Siegeswaffenproduktion: Weitere Spurensuche nach Thuringens Manhattan Project* (Schleusingen: Amun Verlag, 1999), pp. 82-83. Original text cited in English.

This exchange is remarkable in several respects, not the least of which is that its "explosive contents" are almost entirely overlooked in standard histories of the war and its aftermath.

Previous chapters have presented evidence that there was a large, and very secret, uranium enrichment program inside Nazi Germany, beginning sometime ca. late 1940 or early 1941, and continuing, apparently unabated - as the surrender of the U-234 would imply - right up to the end of the war. Zinsser's affidavit goes further, and alleges an actual atom bomb test, complete with descriptions of all the signatures of an atom bomb: mushroom cloud, electromagnetic pulse effects, and continued combustion of nuclear materials in the cloud. The Japanese military attaché in Stockholm further corroborated the story with undeniably fantastic allegations of the German use of some type of weapon of mass destruction on the Eastern Front ca. 1942 (the siege of Sevastopol in the Crimea), to 1943, just days prior to the massive German offensive at Kursk.

Now, at Nuremberg, we have a third corroboration of the use of some type of weapon of awesome explosive power in the east by the Germans, this time from no less an individual than the chief American prosecutor at the Tribunal. And in his case, it is apparent that he is relating information gathered by intelligence. It is worth pausing to consider the implications of the exchange between Jackson and former armaments Reichminister Speer.

We shall begin with Speer. **Albert Speer** was successor to Dr. **Fritz Todt** as minister of armaments and production for the entire Third Reich. Speer's accomplishments are not to be gainsaid, it was largely owing to his efforts to organize the huge Nazi industrial capacity and streamline its efficiency that the wartime production of Germany increased dramatically under his oversight. In fact, in all pertinent areas of German industrial war production, Speer managed to achieve peak production levels in all categories during the same precise period that Allied strategic bombing also was at its height.

His methods in achieving this feat were simple but effective: German industry was decentralized and dispersed into smaller plants, and, to the extent possible, moved into underground bomb-proof factories. "Modular" construction techniques were employed wherever possible. For example, German U-boats were produced in modular fashion, in sections, far inland in such factories, and transported to ports for final assembly. The deadly Type XXI U-boats with their exotic and revolutionary underwater propulsion systems - allowing an underwater cruising speed in excess of 21 knots, an unheard of speed for that time - were produced in this fashion at the end of the war.

But notably absent from Speer's comments is any indication that he was even aware of the huge extent of the German atom-bomb project and its enormous uranium enrichment program. Lofty as his position in the Nazi hierarchy was, it would appear that Speer was entirely in the dark on the programs and totally oblivious to any progress that had been made. The reason for Speer's ignorance will be addressed in due course (and by Speer himself!), but suffice it to say, the German government, like its American counterpart, had rigidly "compartmentalized" its atom bomb production program and placed it under the tightest security. But clearly, by the time of the exchange between Jackson and him, Speer and the whole world had heard of the atom bomb. So Speer appears to obfuscate his answer somewhat by redirecting the topic to chemical warfare.

The question of a revolutionary chemical explosive is not, however, as far-fetched as it might at first seem, for Jackson's comments suggest it by referring to temperatures of 400 to 500 degrees centigrade, far below the enormous temperatures produced by an atomic explosion. Was Speer obfuscating his answer, or was Jackson his question?

The prosecutor's statements and question also corroborate in loose fashion another component of our developing story, for he clearly alludes to the use of some type of weapon of mass destruction, possessed of enormous explosive power, in the east, and significantly, at or near Auschwitz, site of the I.G. Farben "Buna factory". It is to be noted that the Nazis had apparently gone so far as to build an entire mock town and placed concentration camp inmates in it, an obvious though barbaric move to study the effects of the weapon on structures and people.

His statements, along with those of the Japanese military attaché in Stockholm cited in the previous chapter, afford a serious clue - and one often overlooked even by researchers into this 'alternative history' of the war - into the nature of the Nazi's secret weapons development and use, for it would appear that insofar as the third Reich possessed weapons of mass destruction of extraordinary power, atomic or otherwise, they were tested and used against enemies considered by the Nazi ideology to be racially inferior, and that means, in effect, they were used on the Eastern Front theater of the Reich's military operations.

Thus we are also afforded a speculative answer to the all-important question: If the Germans had the bomb, why didn't they use it? And the answer is, if they had it, they were far more likely to use it on Russia than on the Western allies, since the war in the East was conceived and intended by Hitler to be a genocidal war from the outset. And it certainly was that: fully one half of the approximately fifty million fatalities of World War Two were inflicted by the efficient Nazi war machine on Soviet Russia.

The use of such weapons on the Eastern Front by the Germans would also tentatively explain why more is not known about it, for it is highly unlikely that Stalin's Russia would have publicly acknowledged the fact. To do so would have been a propaganda disaster for Stalin's government. Faced with an enemy of superior tactical and operational competence in conventional arms, the Red Army often had to resort to threats of execution against its own soldiers just to maintain order and discipline in its ranks and prevent mass desertion.

Acknowledgment of the existence and use of such weapons by the mortal enemy of Communist Russia could conceivably have ruined Russian morale and cost Stalin the war, and perhaps even toppled his government. As we proceed further into our investigation of German secret weaponry, its connection to Nazi ideology, and its use on the eastern front, we will encounter more and more examples of the strange story or event.

For now, however, we note the strangely ambiguous quality of Mr. Jackson's remarks.

"Now I have," he begins, "'certain' information, which was placed in my hands, of an experiment which was carried out near Auschwitz..."

By the time Mr. **Jackson** uttered these remarks, **Hans Zinsser's** statements were almost a year old, raising the possibility that Zinsser's affidavit may itself have been the "certain information" alluded to by Jackson, who may have intentionally altered its correct location. In this regard, it is significant that Zinsser expressed mystification that the test took place so close to a populated area. If Jackson deliberately altered the location of the test, he did not alter the nature of its victims. But another possibility is that the event took place where he says it did, "near" Auschwitz.

## **B. A Marshal, Mussolini, and the First Alleged Test Site at RugenIsland**

The question of the location of a possible German atom bomb test comes from five very unlikely sources: an Italian officer, a Russian marshal's translator, and Benito Mussolini himself, an American heavy cruiser, and an island off the coast of northern Germany in the Baltic Sea.

Before he and his mistress Clara Petacci were murdered by Communist partisans, and then later hung from meat hooks in Milan to be pelted with rocks from an angry mob. Benito Mussolini, by the end of the war reduced to a mere puppet of Hitler and governing a "Fascist republic" in German-controlled northern Italy, spoke often of the German "wonder weapons":

The wonder weapons are the hope. It is laughable and senseless for us to threaten at this moment, without a basis in reality for these threats.

The well-known mass destruction bombs are nearly ready. In only a few days, with the utmost meticulous intelligence, Hitler will probably execute this fearful blow, because he will have full confidence.... It appears, that there are three bombs - and each has an astonishing operation. The construction of each unit is fearfully complex and of a lengthy time of completion.<sup>2</sup>

It would be easy to dismiss Mussolini's statements as more delusional and insane ravings of a fascist dictator facing defeat, clinging desperately to forlorn hopes and tattered dreams. It would be easy, were it but for the weird corroboration supplied by one Piotr Ivanovitch Titarenko, a former military translator on the staff of Marshal **Rodion Malinovsky**, who handled the Japanese capitulation to Russia at the end of the war. As reported in the German magazine *Der Spiegel* in 1992, Titarenko wrote a letter to the Central Committee of the Communist Party of the Soviet Union. In it, he reported that there were actually three bombs dropped on Japan, one of which, dropped on Nagasaki prior to its actual bombing, did not explode. This bomb was handed over by Japan to the Soviet Union.<sup>3</sup>

Mussolini and a Soviet marshal's military translator are not the only ones corroborating the strange number of "three bombs", for yet a fourth bomb may actually have been in play at one point, being transported to the Far East on board the US heavy cruiser *Indianapolis* (CA 35), when the latter sank in 1945.<sup>4</sup>

<sup>2</sup> Benito Mussolini, "Political Testament," April 22, 1945, cited in Edgar Meyer and Thomas Mehner, *Hitler und die „Bombe“: Welchen Stand erreichte die deutsche Atomforschung und Geheimwaffenentwicklung wirklich?* (Rottenburg: Kopp Verlag, 2002), p. 87, my translation from the German.

<sup>3</sup> Edgar Meyer and Thomas Mehner, *Das Geheimnis der deutschen Atombombe: Gewann Hitlers Wissenschaftler den nuklearen Wettlauf doch? Die Geheimprojekte bei Innsbruck, im Raum Jonastal bei Arnstadt und in Prag.* (Rottenburg: Kopp Verlag, 2001), p. 146.

These strange testimonies call into question once again the Allied Legend, for as has been seen, the Manhattan Project in late 1944 and early 1945 faced critical shortages of weapons grade uranium, and had yet to solve the fusing problem for the plutonium bomb. So the question is, if these reports are true, where did the extra bomb(s) come from? That three, and possibly four, bombs were ready for use on Japan so quickly would seem to stretch credulity, unless these bombs were war booty, brought from Europe.

But the strangest evidence of all comes from the German island of Rugen, and the testimony of Italian officer Luigi Romersa, an eyewitness to the test of a German atom bomb on the island on the night of 11-12 October, 1944, approximately the same time frame as indicated in Zinsser's affidavit, and it is also the same approximate area as Zinsser indicated.

In this context it is also extremely curious that this time frame in 1944 was, for the Allies, a banner year for atomic bomb scares. On Saturday, August 11, 1945, an article in the London Daily Telegraph reported British preparations for German atom bomb attack on London the previous year.

## **NAZIS' ATOM BOMB PLANS BRITAIN READY A YEAR AGO**

Britain prepared for the possibility of an atomic attack on this country by Germany in August, 1944.

It can now be disclosed that details of the expected effect of such a bomb were revealed in a highly secret memorandum which was sent that summer to the chiefs of Scotland Yard, chief constables of provincial forces and senior officials of the defense services.

An elaborate scheme was drawn up by the Ministry of Home Security for prompt and adequate measures to cope with the widespread devastation and heavy casualties if the Germans succeeded in launching atomic bombs on this country.

Reports received from our agents on the Continent early last year indicated that German scientists were experimenting with an atomic bomb in Norway. According to these reports the bomb was launched by catapult, and had an explosive radius of more than two miles.

In view of our own progress in devising an 'atomic' bomb the Government gave the reports serious consideration. Thousands of men and women of the police and defense services were held in readiness for several months until reliable agents in Germany reported that the bomb had been tested and proved a failure.<sup>5</sup>

"Nazis Atom Bomb Plans," London Daily Telegraph, Saturday, August 11, 1945, cited in Edgar Meyer and Thomas Mehner, Hitler und die "Bombe", p. 37.

# NAZIS' ATOM BOMB PLANS

## BRITAIN READY A YEAR AGO

Britain prepared for the possibility of an atomic bomb attack on this country by Germany in August, 1944.

It can now be disclosed that details of the expected effect of such a bomb were revealed in a highly secret memorandum which was sent that summer to the chiefs of Scotland Yard, chief constables of provincial forces and senior officials of the defence services.

An elaborate scheme was drawn up by the Ministry of Home Security for prompt and adequate measures to cope with the widespread devastation and heavy casualties expected if the Germans succeeded in launching atomic bombs on this country.

Reports received from our agents on the Continent early last year indicated that German scientists were experimenting with an atomic bomb in Norway. According to these reports the bomb was launched by catapult, and had an explosive radius of more than two miles.

In view of our own progress in devising an "atomic" bomb, the Government gave the reports serious consideration. Thousands of men and women of the police and defence services were held in readiness for several months until reliable agents in Germany reported that the bomb had been tested and proved a failure.

**The August 1945 London Daily Telegraph Article about a 1944 German Atom Bomb Scare in Britain**

This article, coming as it does a mere two days after the bombing of Nagasaki, and almost a year since the actual alert in Britain was called, deserves careful scrutiny.

First, and most obviously, the alert in Britain was apparently conducted entirely in secret, as law enforcement, defense, and medical personnel were placed on high alert. The reason for security is obvious, since to have signaled a public alert would have notified the Germans that there were Allied spies close enough to the German bomb program to know about its tests.

Second, the site of the alleged test - Norway - is unusual in that the timing of the test would place it a full two years after the British commando raid on the Norsk heavy water plant at Ryukon. This might indicate two things:



(1) It might indicate that Hitler's interest in maintaining troops in Norway had more to do with the German atom bomb project than anything else, since, if the report was accurate to begin with, it would indicate a large scale German atom bomb effort was underway there;

(2) Conversely, the report may have been deliberately inaccurate, i.e., there may really have been a test, but one that took place somewhere else.

Third, the presumed "alert" continued from August 1944 "for several months," that is, the alert could conceivably have stretched into October, i.e., into the time frame of the test mentioned in Zinsser's affidavit. Thus, the news account indicates something else: Allied intelligence was aware, and genuinely fearful, of German atom bomb testing.

Fourth, the article mentions that the test concerned a bomb launched from a "catapult". The V-1 "buzz bomb", the first generation of the cruise missile, was launched from large steam-driven catapults. Putting two and two together, then, the "Norway" test may have been a test of an atom bomb delivery system based on the V-1, or of an atom bomb itself, or possibly both an atom bomb and its delivery system.

With these thoughts in mind, we come to the final point. The alert was canceled when the test was proven a failure. The question is, what failed? Was it the bomb itself? The delivery system? or both? An answer lies, perhaps, in another curious news article that appeared in the British press almost a year earlier, on Wednesday, October 11, 1944, in the London Daily Mail:

**BERLIN IS 'SILENT' 60 HOURS STILL NO PHONES**  
STOCKHOLM, Tuesday

Berlin is still cut off from the rest of Europe to-night. The 60- hours silence began on Sunday morning - and still there is no explanation for the hold-up, which has now lasted longer than on any previous occasion.

The Swedish Foreign Office is unable to ring up its Berlin Legation.

Unconfirmed reports suggest that the major crisis between the Wehrmacht and the Nazi Party has come to a head and that "tremendous events may be expected."

To-day's plane from Berlin to Stockholm arrived four hours late. It carried only Germans, two of whom appeared to be high officials. They looked drawn and pale, and when Swedish reporters approached them they angrily thrust their way out of the Swedish Aero-Transport offices, muttering: "Nothing we can say."

German papers arriving here on to-day's plane seem extraordinarily subdued, with very small headlines.

It is pointed out, however, in responsible quarters that if the stoppage were purely the technical result of bomb damage, as the Germans claimed, it should have been repaired by now.<sup>6</sup>

<sup>6</sup> Walter Farr, "Berlin is 'Silent' 60 Hours: Still No Phones," London Daily Mail, Wednesday, October 11, 1944, cited in Meyer and Mehner, Hitler und die „Bombe" p. 81, emphasis added.



The October 1944 Daily Mail Article about Berlin Telephone Service Disruption

Of course we now know what was not known in October of 1944: when an atomic or thermonuclear bomb is detonated, the extreme electromagnetic pulse knocks out or interferes with electrical equipment for miles from the detonation site, depending on the size of the blast, the proximity of such equipment to it, and the degree of "shielding" such equipment has. For the normal, non-military phone lines in Berlin, the strange disruption of phone service is explainable precisely as the result of such an electromagnetic pulse.

But this would imply that such a pulse, if the result of an atom bomb test, be considerably closer to Berlin than Norway. Presumably if telephone service in Berlin was affected by an atom bomb test in Norway, similar disruptions would have occurred in large cities that were much closer to the test, such as Oslo, Copenhagen, or Stockholm. Yet, not such disruptions are mentioned; only Berlin appears to have been affected.<sup>7</sup>

Thus, if the atom bomb test mentioned in the 1945 London Daily Telegraph article occurred, then one must look for a site considerably closer to Berlin than Norway. The Daily Mail phone service disruption article stands as clear corroboration of the probable test of a German atom bomb sometime in October of 1944, the same time frame as Zinsser's affidavit, and within the time frame mentioned in the Daily Telegraph article about a secret alert in Britain from August of 1944, and continuing for "several months."

But the Daily Mail's phone service disruption article does more: it suggests why the Germans may have considered the test a failure. At that time the effects of nuclear explosions -electromagnetic pulse and disruption of electrical equipment, radioactivity and fallout - were still largely unknown and not well understood. The Berlin telephone service was one of the finest, if not the finest, in the world at the time.<sup>8</sup>

<sup>7</sup> There is another possibly, though extremely unlikely explanation, for the lack of reports in other cities. Very simply, it may reflect a lack of intelligence from those areas.

<sup>8</sup> Up to the very end of the war, for example, the cable lines between Berlin and Tokyo remained open, allowing the Japanese to send condolences to the Nazi government even as Russian tanks were rolling over the streets of the city.

The Nazis may very well have been shocked at this curious result of their alleged test of an atomic "wonder weapon", and therefore considered it a "failure" until more tests could be done and the phenomenon of electro-magnetic pulse more fully understood. After all, it would do no good, so to speak, to deploy the "ultimate weapon" only to be unable to receive the telephone call of surrender after having used it! And to the totalitarian and paranoid Nazi state, a disruption of communications from its capital city to its provinces, armed forces, and occupied territories was literally an unthinkable nightmare, being the perfect opportunity for a coup d'etat.

Finally, to round out the newspaper scavenger hunt, a curious series of articles from the London Times between May 15 and May 25, 1945, covered a story about German troops on the Danish Baltic Sea island of Bornholm that refused to surrender to attacking Russian forces.<sup>9</sup> Bornholm was within one hundred miles of the German rocket site at Peenemunde, and quite close to an alleged atom bomb test site on the small island of Rugen on the Baltic coast close to the port city of Kiel.

<sup>9</sup> Meyer and Mehner, *Das Geheimnis der deutschen Atombombe*, p. 51.

Most communications lines in Berlin were laid underground by the Deutsche Reichspost before the war for the express purpose of mitigating phone service disruption during bombing attacks. If the phone service disruption was therefore a result of EMP from a nuclear detonation, then the size of the detonation would have to have been rather large to cause this lengthy disruption of the entire city's telephone service for that length of time, shielded as the lines were by being underground. The other alternative, a second coup attempt, may be a possible explanation, but there is no mention of such an attempt in any literature.

It is here on this island that Italian officer **Luigi Romersa** was the guest and eyewitness to a German "wonder weapon" test on the night of October 11-12, 1944. After journeying by a night drive for two hours in the rain from Berlin, Romersa reached the island by motorboat. According to his statements to German atom bomb researchers Edgar Meyer and Thomas Mehner, the island was guarded by a special elite unit, which we can only presume was an SS unit, and that admission to the island was only granted by special passes issued directly by the Oberkommando Der Wehrmacht (OKW).<sup>10</sup>

At this point, it is best to cite Romersa's own words:

There were four of us: my two attendants, a man with worker's clothes, and I. "We will see a test of the disintegration bomb."<sup>11</sup> It is the most powerful explosive that has yet been developed. Nothing can withstand it," said one of them. He hardly breathed. He glanced at his watch and waited until noon, the hour for the experiment. Our observation post was a kilometer from the point of the explosion. "We must wait here," the man with the worker's clothes ordered, "until this evening. When it is dark we may leave. The bomb gives off deathly rays, of utmost toxicity. its effective area is much larger than the most powerful conventional bomb. Around 1.5 kilometers...."

Around 4:00 PM, in the twilight, shadows appeared, running toward our bunker. They were soldiers, and they had on a strange type of "diving suit". They entered and quickly shut the door. "Everything is kaput," one of them said, as he removed his protective clothing. We also eventually had to put on white, coarse, fibrous cloaks. I cannot say what material this cloak was made of, but I had the impression that it could have been asbestos, the headgear had a piece of mica-glass<sup>12</sup> in front of the eyes.

Having donned this clothing, the observation party then left the bunker and made its way to ground zero:

The houses that I had seen only an hour earlier had disappeared, broken into little pebbles of debris, as we drew nearer ground zero,<sup>13</sup> the more fearsome was the devastation. The grass had the same color as leather, the few trees that still stood upright had no more leaves.<sup>14</sup>

There are peculiarities of Romersa's account that one must mention, if this were the test of nuclear bomb. First, some of the blast damage described is typical for a nuclear weapon: sheering of trees, obliteration of structures, and so on.

<sup>10</sup> Meyer and Mehner, *Hitler und die „Bombe"*, p. 64.

<sup>11</sup> "Auflosungsbombe".

<sup>12</sup> "Glimmerglas".

<sup>13</sup> "Explosionspunkt".

<sup>14</sup> Luigi Romersa, private telephone interview with Edgar Meyer and Thomas Mehner, *Hitler und die „Bombe"*, pp. 62-66, my translation from the German.

The protective clothing worn by the German technicians as well as the polarized glasses also are typical. And the test does appear to have involved use in a "populated area" with houses and so on, in similar fashion to prosecutor Jackson's exchange with Speer, and Zinsser's own comments in his affidavit. However, Romersa, apparently a careful observer, fails to make any mention of a fusion of soil into silicate glassy material that also normally accompanies a nuclear blast close to the ground.

But whatever was tested at Rugen, it does have enough of the signatures of an atom bomb to suggest that this is, in fact, what it was. Most importantly it is to be noted that it coincides with the time frame of Zinsser's affidavit and the phone

service outage in Berlin, and the timing of the British alert.<sup>15</sup> Finally, it is perhaps quite significant that during this same time frame, Adolf Hitler finally signed an order for the development of the atom bomb. In context, this can only mean that he has given approval to develop more of a weapon already tested.<sup>16</sup>

15 One significant difference that does emerge is that Zinsser's affidavit places the test close to the hours of twilight, whereas Romersa has it taking place in full daylight. The latter would make sense, from a security point of view, since daylight would tend to mask the visibility of the blast more effectively from prying eyes in the distance.

16 Rose, *op. cit.*, notes that Hitler actually gave a formal order in October of 1944 for the immediate development of the atom bomb.

## C. The Three Corners (Dreiecken) and the Alleged Test at the Troop Parade Ground at Ohrdruf

A more controversial allegation, however, concerns the alleged test of a high yield atom bomb by the SS at the troop parade ground and barracks at Ohrdruf, in south central Thuringia in March of 1945. As we shall see, this date too is significant. Shortly after the German reunification in 1989, old rumors of an atom bomb test conducted by the SS late in the war in south central Germany, in what was formerly East Germany, again surfaced. The test is alleged to have taken place on March 4, 1945.<sup>17</sup>

17 Meyer and Mehner, *Hitler und die „ Bombe " , p. 226.*

However, as we shall soon see, there is an additional problem associated with the allegation of this test near the Three Corners. The Three Corners part of the story begins with a component of the Allied Legend. According to former Last German sources, one plausible reason for the swift advance of US General Patton's divisions on this region of Thuringia was that the last Fuhrer Headquarters (Führerhauptquartier), a facility code-named "Jasmine" by the Germans, was located in the vast underground facilities at Jonastal.<sup>18</sup>

"There exists an American document, under point number four, that informs us that the last (Fuhrer Headquarters) was not at the Obersalzberg, but in the region of Ohrdruf,"<sup>19</sup> that is, in the region of the Three Corners.

Thus, the Legend is elaborated: Patton's drive was to cut off the escape route of fleeing Nazis and seize Hitler's last secret underground headquarters, and, presumably, the Grand Prize himself.

This entire facility was part of a vast complex of underground sites under the command structure of the SS, and named "S III" - a designation not without its own suggestive possibilities as we shall discover in subsequent parts of this work - and the Fuhrer Headquarters was but one component of this complex.<sup>20</sup>

The problem with the view that this complex was simply a headquarters complex is that SS Obergruppenführer **Hans Kammler** - a man with whom we shall have much to do later in this work - was directly involved in the construction of all facilities in the region since 1942, thus making it unlikely that they were constructed merely for Hitler's last headquarters, since Kammler was directly involved with the most sensitive areas of the Reich's secret weapons research and development.

It is therefore more likely that they were a part of Kammler's vast SS Secret weapons black projects empire.<sup>21</sup> There is no mention of any of these facilities in surviving German archives, or, seemingly, any where else for that matter, and yet, they are definitely there for all to see.<sup>22</sup>

18 Meyer and Mehner, *Das Geheimnis der deutschen Atombombe*, p. 209.

19 Meyer and Mehner, *Das Geheimnis*, p. 207.

20 *Ibid.*, p. 213., "Report of Mr. Oskar Muhlheim, Bad Durenberg."

21 *Ibid.*, p. 239.

22 *Ibid.*, p. 240.

So what were these facilities researching? Almost nothing was known about them until witnesses and relatives of witnesses began to talk after German reunification. One such man was Adolf Bernd Freier who, before his death in Argentina, wrote German researchers **Edgar Meyer** and **Thomas Mehner** a letter detailing his knowledge of the facilities gained while he was on the construction staff. There were, Freier alleged, facilities dedicated to special circular aircraft(!), to the "Amerika Raket", the intercontinental ballistic missile capable of reaching the United States, and research facilities of atomic experiments under the direction of Dr. **Kurt Diebner**, and a complete underground factory for the production of heavy water!<sup>23</sup>

But most importantly, Freier alleges that the "atomic weapon" was ready on July 2, 1944!<sup>24</sup> What type of atomic weapon is meant here? A "dirty" radiological bomb, designed to spray a vast area with deadly radioactive material but far short of an actual nuclear fission bomb? Or an actual atom bomb itself?

23 Meyer and Mehner, *das Geheimnis*, p. 242.

24 *Ibid.*, p. 245. According to Freier's allegations, the bomb was ready on July 2, 1944, but not its delivery system, meaning presumably the "Amerikaraket" (p. 249).

Freier's choice of words is not clear. But one thing does stand out, and that is the date of July 2, 1944, the same month as the attempt to assassinate Adolf Hitler in the - very aptly named - "Bomb Plot" approximately two weeks later. The consequence of a successful German development of even a radiological bomb might thus be one of the primary motivations for the anti-Hitler conspirators to attempt to remove the Fuhrer when they did, and might explain their hidden logic in assuming that the Allies would negotiate with an anti-Nazi (or at least un-Nazi) provisional German government in spite of the Allies' own demands for an unconditional surrender, for the possession of such a weapon would have given the conspirators considerable negotiation leverage.

And if the conspirators knew of the existence of the weapon, and of Hitler's plans to deploy it in actual use, it may have been the final moral compulsion for them to act.

In any case, the most problematical aspect of the alleged test of an atom bomb by the Nazis in the Ohrdruf-Three Corners region of Thuringia comes from a rather specific, and rather startling, assertion. According to Freier, the test took place on March 4, 1945 at the old troop parade ground at Ohrdruf. There, a small scaffold about 6 meters high had been erected, a the top of which a small "atomic weapon"<sup>25</sup> was placed. The weapon, according to Freier, was "100 g", a mere one hundred grams!

This is one of the most significant, and highly problematical, allegations regarding the real nature of the Nazi atom bomb project, made by someone supposedly involved in it, for as will be immediately obvious, 100 grams is far short of the 50 or so kilograms of critical mass reportedly needed for a uranium-based atom bomb, as has been seen, and it is still well below the amount needed for the critical mass for a typical plutonium bomb. Yet, Freier is insistent upon this point, and moreover alleges that all the "slaves", the luckless concentration camp victims that were forced to take part in the test, within a circle of 500-600 meters from ground zero were killed.<sup>26</sup>

25 "A-Waffe", the wording again is not "Atombombe" but only A-waffe, or "A-weapon".

26 Meyer and Mehner, *Das Geheimnis*, p. 245.

This would give an area of approximately 1 to 1.2 kilometers of blast damage, roughly the effect of a modern tactical nuclear bomb. Such a blast radius would require an enormous amount of the then available conventional explosives, and that amount would far exceed the mere 100 grams Freier alleges for the device. These points indicates that the "A-Waffe" or "atomic weapon" was in fact a fully fledged atom bomb. So how does one explain the extraordinarily small critical mass, especially since the Manhattan Project was aiming for a uranium critical mass of around 50 kilograms?

This question deserve serious consideration, for it affords yet another possible clue - if the allegation is to be credited with accuracy - into the real nature of the Nazi atom bomb project. We have seen already that the project was developed under several different and discreet groups for reasons partly due to security, and for reasons partly due to the practical nature of the German program. For security reason, I believe the "Heisenberg" group and the high-profile names associated with it were deliberately used by the Nazis as the "front" group for public, namely Allied, consumption.

The SS security and intelligence apparatus would have undoubtedly concluded, correctly, that these high profile scientists would be high priority targets for Allied intelligence for kidnapping and assassination. Accordingly, it is highly unlikely that the Nazis would have concentrated any genuine atomic bomb secrets or development exclusively in the hands of this group. The very existence of the Allied Legend for so many years after the war is direct testimony to the success of this plan. The real atom bomb development occurred far from the prying eyes of Allied intelligence, under the auspices of the Reichspost and more importantly, under the direct auspices of the SS.

The second facet of the German atom bomb program we have likewise previously encountered: its emphasis on what was practically achievable during the war. Hence, while the Germans knew of the possibilities of plutonium and a plutonium-based atom bomb, and therefore knew that a functioning reactor used to produce plutonium for bombs would thereby enable Germany to develop more bombs for the same investment of fissile material, they also knew that a major technical hurdle lay across the path: the development of a successful reactor in the first place.

Thus, as has been previously argued, they opted to develop a uranium-based bomb only, since uranium could be enriched to weapons grade purity without the necessity of the development of a reactor, and since they already possessed the necessary technologies to do so, if employed en masse. Like its American Manhattan Project counterpart, the SS-run program relied on massive numbers of enrichment units to separate and purify isotope.

Now let us extend this line of reasoning further. Germany was also seeking to be able to deploy such bombs as warheads on its rockets. And that meant, given their limited lift capabilities, that the weight of the warheads had somehow to be reduced by several orders of magnitude for the rockets to be able to carry them. And there is an economic factor.

Knowing that their industrial capacity would be strained by the effort, even with the help of tens of thousands of slave laborers from the camp-, another problem may have presented itself to the Germans, a problem illuminated for them by their own knowledge of the possibilities offered by plutonium-based bombs: How does one get more bang for the Reichsmark without the use of plutonium? Is there a way to rely on less uranium in a critical mass assembly than is conventionally thought?

And so we return to Freier's statement of a remarkably small 100 g atom bomb test at Ohrdruf on March 4, 1945. There does exist a method by which much smaller critical masses of fissile material can be used to make a bomb: boosted fission. Essentially, boosted fission simply relies on the introduction of some neutron-producing material - polonium, or heavy hydrogen: deuterium, or even tritium - to release more neutrons into the chain reaction than is actually released by the fissile critical mass assembly by itself.

This raises the amount of free neutrons initiating chain reactions in the critical mass, and therefore allows two very important things:

- (1) It allows slightly lower purity of fissile material - materially not considered of sufficient purity to be weapons grade without boosted fission - to be used for an actual atom bomb; and,
- (2) it requires less actual fissile material for the critical mass assembly to make a bomb.

Thus, "boosted fission" would have afforded the German bomb program a practical way to increase the number of bombs available to them, and a reliable method for achieving an uncontrolled nuclear fission reaction with lower purity of enriched material.<sup>27</sup> It is perhaps quite significant, then, that Freier's testimony concerning the Three Corners underground weapons factories also mentions the existence of an underground heavy water plant in the facilities, for heavy water, of course, contains atoms of deuterium and tritium (heavy hydrogen atoms with one and two extra neutrons in the nucleus respectively).

27 Q.v. Meyer and Mehner, Hitler, pp. 121-123.

In any case, the test of a small critical mass, boosted fission device of high yield at Ohrdruf on March 4, 1945, is at least consistent with the parameters of the German bomb program and its practical needs. But there are interesting, and intriguingly suggestive, corroborations of the test. According to Freier, Hitler himself was indeed in the Three Corners headquarters for a brief period at the end of March 1945.<sup>28</sup>

It is known that Hitler did personally visit and address the officers of the German Ninth Army, operating in that precise area, in March of 1945., and stated to them that there were still things that needed to be "finished", an interesting comment if seen in the light of Freier's allegations that it was not the bomb that Germany needed, but the delivery systems. It does make sense that if there were such a test, that Hitler would have been present as an observer to witness the final success of German science in delivering to him the "ultimate weapon".

But perhaps the most persuasive bit of evidence that there is far more about the end of World War Two than we have been told can be found in two exceedingly odd facts that emerge from the Three Corners region of Thuringia in south central Germany. In a statement made on March 20, 1968, former German General **Erich Andress** was in the Three Corners region at the end of the war, when suddenly, more American military personnel (who were already occupying the area), arrived with jeeps and heavy transports, and immediately ordered all the buildings and houses in the area to have their windows totally blacked out, leaving one to conclude that the Americans were removing something from the area of great value to them, something they wished no one to see.

The second odd fact is even more curious, for it is a fact that, of all the areas in modern Germany, the region of Thuringia, precisely in the area of Jonastal and Ohrdruf, is the region of Germany with the highest concentration of background gamma radiation.<sup>29</sup>

So, what is really signified by the unique exchange of remarks between former Reich Minister of Armaments **Albert Speer**, and Chief American Prosecutor **Jackson** at Nuremberg? That Jackson is privy to information similar in nature to reports only recently declassified is clear from his question. That this information concerns the real nature of German atom bomb research and its -what appear to be astounding achievements completely at variance with the postwar Allied Legend - would also seem to be indicated.

And that Albert Speer seems either unwilling to talk about them candidly, or is simply entirely ignorant of them, also seems indisputable. Thus Jackson's question would seem to imply a test of the extent of Speer's knowledge of the program and his complicity in the two tests at Rügen and Ohrdruf. If the Minister of Armaments for the entire Third Reich knew nothing of it, then indeed, we are dealing with a black Reich within the black Reich, a beast in the belly of the beast, of which even high ranking Nazis such as Speer knew very little, if anything.

The great secret of World War Two, one which the victorious Allies and Russians wish to keep secret to this day, was that Nazi Germany was indisputably first to reach the atom bomb, and was indisputably for a very brief period before the end of the war, the world's very first nuclear power. But why is the Allied and Russian secrecy continued even to the present day? The answer to that disturbing question will be addressed more completely in the subsequent parts of this book, for the answer, disturbing as it is, concerns far more than mere nuclear weapons. But why didn't the Nazis use their bombs if they had them?

The answer to that question has already been partly addressed in this chapter: if they used any weapons of mass destruction, nuclear or otherwise, they would have been far more likely to have used them in a fashion consistent with their racist and genocidal ideology, as well as against the enemy that was their largest military threat: on the Eastern Front, against the Soviet Union, where a paranoid Stalinist regime would have been loathe to admit to the world or to its own war-savaged people that they faced an enemy with overwhelming technological superiority.

Such an admission would likely have so demoralized the Russians, already forced to spend rivers of their own blood in every engagement with the Wehrmacht, that Stalin's regime itself may not have survived such an admission. But why not use them against the Western Allies in the last stages of the war, as the military situation grew increasingly desperate? There is every indication that the Nazi leadership contemplated just such an operation....

[Back to Contents](#)

## Chapter 5

### STRANGE MAPS, STRANGE FLIGHTS, AND UNKNOWN CARGOES

"Gerlach goes on to explain that the Nazi party seemed to think that they were working on a bomb and relates how the Party people in Munich were going around from house to house on the 27th or 28th of April last telling everyone that the atomic bomb would be used the following day."

**Jeremy Bernstein,**

*Hitler's Uranium Club: The Secret Recordings at Farm Hall* <sup>1</sup>

<sup>1</sup> Jeremy Bernstein, *Hitler's Uranium Club: The Secret Records at Farm Hall* (Copernicus, 2001), p. 126.

The United States was in a unique position among all the powers involved in World War Two. For the last time in its history, it was able to undertake military operations on a global scale relatively free of the fear of enemy reprisal. Its cities and factories were beyond the reach of any known enemy bomber. Moreover, much of its industrial capacity was located in its interior, far from the northeastern Atlantic States or the Pacific coast.

According to conventional wisdom that has been reiterated countless times in numerous standard histories of the war, there was absolutely nothing the United States had to fear from Nazi Germany with its "tactical mission-oriented Luftwaffe" or its puny navy. To this day, many Americans, even ones relatively familiar with the operational details of World War Two, believe that Germany had no aircraft even capable of reaching the United States and returning to Europe, much less of carrying a heavy enough payload, or being available in sufficient numbers, to be of any military significance.

All that changes, however, if Germany had the atomic bomb and if she possessed aircraft capable of delivering one and of returning successfully to Europe. In that case, only one bomber need be used to strike a significant military and psychological blow against the United States.

- Was such an operation feasible?
- Did Germany have such aircraft at least capable of being modified to carry an atom bomb?
- Are there indications that such studies and operations were contemplated by the Nazis?

## **A. The Oberkommando der Luftwaffe's Unusual Map**

In 1943 the Supreme Command of the Luftwaffe (Oberkommando der Luftwaffe) conducted a highly unusual study. The study consisted of a map, a map of lower Manhattan Island. On the map are concentric circles detailing the blast and heat damage- radii of an atomic bomb detonation over New York City. But the most unusual aspect of this "study" is that it shows the detonation of an atom bomb in the 15-17 kiloton range, approximately the same yield as the Little Boy uranium bomb dropped on Hiroshima, an odd "coincidence" in the series of "odd coincidences" we have- already encountered.

The Luftwaffe's intentions are quite obvious and clear. The destruction of the financial and business center of New York City would alone have been an unparalleled military and psychological blow against the American war effort. Beyond this, given the fact that New York City was an important point of embarkation for American shipping and troops, as well as a naval base, and a transportation hub for the entire American northeast, such a blow would have been incalculable.

For the Nazi leadership, such a blow would have made military and political sense. It would have demonstrated conclusively to the United States that Germany was capable of mounting significant military operations against the American mainland, and at levels of destructive capability that were militarily, economically, and psychologically devastating.

From their point of view, such a blow would arguably been seen as weakening American resolve and perhaps, after a succession of similar such blows against prominent targets such as Boston, Philadelphia, Washington DC or Norfolk, would conceivably have led to America's exit from the war, leaving Britain to follow not far behind. The war against the Soviet Union could then either have been prosecuted without mercy until the inevitable Soviet capitulation, or at the minimum, a negotiated peace highly favorable to the Reich.

In October of 1943, then, such a study was a tempting prospect. But is there any indication that the OKL's "study map" was anything more than a study? From the evidence presented thus far, the answer is clearly that the Luftwaffe was not merely conducting the typical staff exercises that all general staffs conduct, even in wartime. For the Luftwaffe, the study was a practical and immanent feasibility.



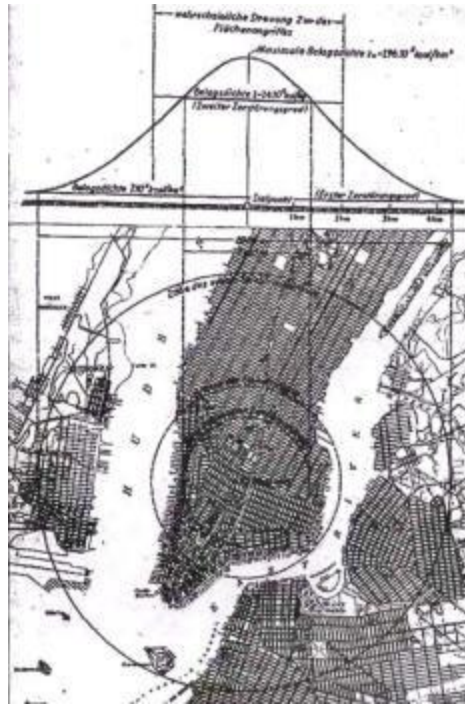

The OKL 's "Feasibility Study" of an Atom Bomb Blast of Hiroshima Size over Manhattan Island in New York City

But what of Freier's allegations that the bomb was ready, but the delivery systems were not? Without a delivery system the German Wehrmacht could have possessed all the atom bombs it wished, but they would have been utterly useless, expensive toys, without a viable means to deliver them to its most significant militarily and economically powerful opponent.

## B. Strange Flights

Did the Germans possess any strategic bombers or aircraft capable of reaching the North American continent with a significant payload, and returning to Europe? Beyond the relatively well-known Messerschmitt 264, a four engine bomber that looks far too similar to the American B-29 to be coincidental, Germany possessed in small numbers a quantity of heavy-lift, ultra-long range transport craft, including the four engine Junkers 290 and its massive six engine cousin, the Junkers 390.

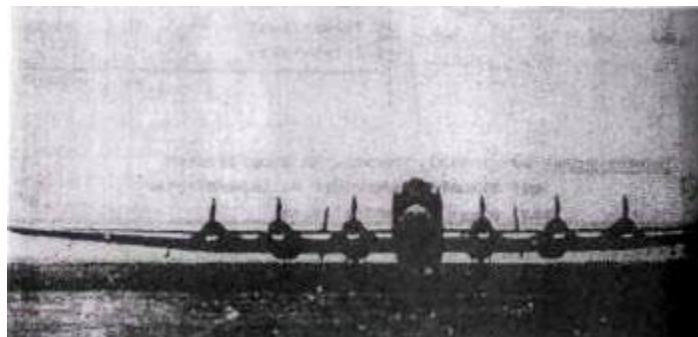

The Junkers 390

Only two of these massive aircraft were ever built. The Junkers 390 assumes an odd significance here (and later) in our story, for in 1994, one such Ju 390 took off from Bordeaux, France, and flew to within 12 miles of New York City, snapped a picture of the Manhattan skyline, and flew back, a non-stop flight of 32 hours.

Within the context of the German SS atom bomb project, this flight was more than a mere feasibility study. Photo reconnaissance could only be for target identification. And the flight itself, to within 12 miles of the city, could conceivably

have been a test of American air defenses and reactions. In any case, the fact that such a flight returned safely can only indicate that the American Army Air Force simply was not expecting a visit from the Luftwaffe at all, reconnaissance, feasibility study, or otherwise.

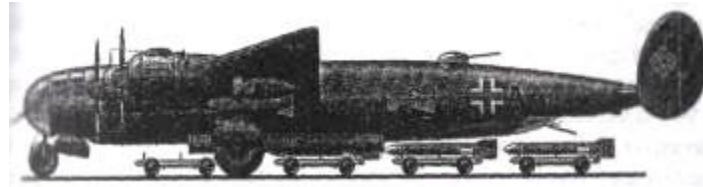

**The Messerschmitt 264 Long Range "Amerikabomber",  
Note the Curious Resemblance to the Boeing B-29 Superfortress**

### C. Unknown Cargoes and a Curious Airfield

The Ju 390 and its smaller four engine cousin the Ju 290 will play another important role in subsequent parts of this book. But perhaps they had a role envisioned for them in conjunction with another little-known, but nonetheless important, fact. In 1945 the Luftwaffe completed construction of an enormous airfield near Oslo, Norway, capable of handling v e r y large aircraft like the Me 264, the He 177, and the Ju 290 and 390. In an article for the June 29, 1945 issue of the Washington Post, a report that originated from 21st Army Group headquarters outlines the frightening discovery that awaited Allied military personnel who came to occupy Norway after the German forces there surrendered:

R.A.F. officers said today that the Germans had nearly completed preparations for bombing New York from a "colossal air field" near Oslo when the war ended.

"Forty giant bombers with a 7,000 mile range were found on this base - the largest Luftwaffe field I have ever seen," one officer said.

"They were a new type bomber developed by Heinkel. They now are being dismantled for study. German ground crews said the planes were held in readiness for a mission to New York.

It is known that **Heinkel** undertook special modifications of its He 177 four engine heavy bomber late in the war, adapting it to carry large atom bombs, radiological bombs, and biological and chemical bombs.<sup>2</sup> Within the context of the SS atom bomb program and the earlier flight of the Ju 390 from France in 1944, however, a purpose immediately suggests itself. The loss of France to Allied forces in 1944 deprived the Luftwaffe of its large French airfields. Norway, however, as has already been stated, remained in German hands up until their very surrender, and thus constituted the only remaining base of operations available to the Germans for any type of offensive operation against the North American continent.

2 Q.v. Friedrich Georg, *Hitlers Siegeswaffen band 1: Luftwaffe und Marine: Geheime Nuklearwaffen des Dritten Reiches und ihre Tragersysteme* pp. 131, 133.

The presence of such an airfield and its deliberate construction so late in the war also strongly suggests a connection to the SS atom bomb program in an entirely different way, since its construction would likely have fallen under the jurisdiction of the SS Building and Works Department, which was under the direction of none other than SS Obergruppenfuhrer Hans Kammler.

It is also significant that jurisdiction over all long range aircraft was also in Kammler's hands by war's end, thus linking the precious long-range bombers on the Oslo field to Kammler as well. Moreover, Mayer and Mehner speculate that at least two atom bombs were built and possibly transported on the mission of the U-234. In their view, the surrender of the U-boat to the American authorities thus not only provided the Manhattan Project with much-needed stocks of enriched uranium, but quite possibly also with two fully functional atom bombs as well.

Professor Friedrich Lachner was assistant for twenty years to professor Mache at the Department for Technical Physics at the Technical University of Vienna. Familiar with aspects of the German bomb project, Lachner unburdened himself of his knowledge to researchers Mayer and Mehner. Among his allegations were that at least one completed bomb of German construction was transported from Thuringia to Salzburg by the SS near the end of the war.<sup>3</sup>

Lachner's letter is intriguing for two reasons. First, because it corroborates the existence of a large atom bomb program in the Three Corners region, and corroborates Freier's allegations of a successful test in March 1945. By mentioning the transportation of such weapons out of the region, he gives some credence to the idea that the U-234 might have been used to transport at least one such weapon to Norway.<sup>4</sup>

<sup>3</sup> Mayer and Mehner, *das Geheimnis*, p. 81. Lachner also asserts unequivocally in his letter to Mayer and Mehner that the bomb dropped on Hiroshima was German (p. 82). Lachner also states that there were no less than fifteen atom bombs in German hands by the war's end. Again, on first glance, this seems a sheer fantasy, unless they had already mastered the techniques of boosted fission. The Salzburg bomb story may not be fantasy, as American tank units were operating in the area late in the war (q.v. pp. 84-85) in conjunction with Patton's drive on Pilsen and Prague.

<sup>4</sup> Italian officer Luigi Romersa mentions as well that the Russians captured two such bombs (*Das Geheimnis*, p. 105).

But a more curious allegation is made in Lachner's letter to Mayer and Mehner, and with it, we begin to approach the even more horrendous potentialities of Nazi wartime secret weapons research. Citing the letter of a British espionage agent who was well-aware of the multi-tiered nature of the German atom bomb program, and who was aware of a "third team that sought another way" of making the bomb (boosted fission),<sup>5</sup> he then mentions a "fourth team":

Yes, and then there was also the fourth team, about which we heard rumors during the last phase of the war. This was certainly so shadowy and fantastic, that one could only construe it as a ploy. But after the war it became evident that the world had avoided a colossal catastrophe by a hair's breath.... This fourth team worked in a field that was monstrous on a daily basis. And when I say this, I meant thereby that they experimented with things that a well-informed public would to thus very day think then to be unthinkable and unbelievable, and thus imaginary. I mean to imply that these specialists worked in conceptions that totally abandoned conventional physical laws.<sup>6</sup>

**Mayer and Mehner** then point out the implications of the agent's remarks in an age long accustomed to think in terms of the destructive power of hydrogen bombs:

That the Germans were working on an atom bomb no one may any longer question, but that they also possessed a team that was working on the destruction of the world is an unbelievable concept. This could only mean that there was a weapons system that possessed enormous range and degree of efficiency that lay beyond that of nuclear weapons technology. Did the Third Reich really prepare the Doomsday Weapon? And if so, where is this technology today? Was it discovered by the Allies or does it lurk secretly deep in the earth waiting for its rediscovery? If such an Ultimate Weapon has already been in existence for more than fifty years, then it is a legitimate question to ask what today's military really, actually possesses.<sup>7</sup>

<sup>5</sup> Mayer and Mehner, *Das Geheimnis*, p. 89. It should be noted, however, that the name of this "well known" British agent is never mentioned.

<sup>6</sup> *Ibid.*, p. 91, my translation and emphasis. The agent then mentions that he is not aware of which side ended up with this technology.

<sup>7</sup> *Ibid.*, pp. 91-92. it is also a legitimate question to ask whose military possesses it, or alternatively, is it in the possession of some altogether unknown entity?

The truthfulness of these stupendous allegations appears to be substantiated by a brief remark uttered by Adolf Hitler to a gathering of Axis elite in April 1944. According to Italian officer **Luigi Romersa** once again, who was present when Hitler made the remarks, the Fuhrer strolled through the room and said,

"We have invisible aircraft, submarines, colossal tanks and cannon, unbelievably powerful rockets, and a bomb with a working that will astonish the whole world. The enemy knows this, and besieges and attempts to destroy us. But we will answer this destruction with a storm and that without unleashing a bacteriological war, for which we are also prepared.... All my words are the purest truth. That you will see!"<sup>8</sup>

Bacteriological war? Bombs with an unbelievable working? Teams of specialists working in areas that defy conventional laws of physics that would threaten a global catastrophe? This is not the picture of a Germany tinkering with V-I buzz bombs, V-2s of limited operational range and strategic value, clumsy and belated attempts to construct a working atomic reactor, and tottering on the brink of total collapse that we have been led to believe.

All the evidence presented thus far tends to the opposite conclusion, that at a minimum the Third Reich possessed functioning atom bombs and was preparing to use them against the West, if she had not already done so against Russia. So the cargoes intended to fly out of that Norwegian airfield may have not only been nuclear, but something far more horrendous.

Already the path through Nazi Germany's nuclear programs have led into very unexpected places and developments, developments only made possible by the recent German reunification and the declassification of German, British, and American archives that it provoked, and suggesting that behind that nuclear program lurks something even larger and far

more monstrous. In any case, it now seems clear why, in spite of Oppenheimer's statement in the middle of May 1945 that the earliest an atom bomb could be ready was in November of 1945,<sup>9</sup> that America was able to overcome all fusing problems and fissile material shortages in a mere two months after the German surrender.

<sup>8</sup> Mayer and Mehner, *Das Geheimnis*, p. 97.

<sup>9</sup> *Ibid.*, p. 131. It is significant that Oppenheimer made these remarks before the capture of the U-234.



**Were Ready to Bomb N. Y.**  
Twenty-first Army Group Headquarters, June 28 (AP).—RAF officers said today that the Germans had nearly completed preparations for bombing New York from a "colossal airfield" near Oslo when the war ended.  
"Forty giant bombers with a 7000-mile range were found on this base—the largest Luftwaffe field I have ever seen," one senior officer said.  
"They were a new type bomber developed by Heinkel. They now are being dismantled for study. German ground crews said the planes were held in readiness for a mission to New York."

The June 29, 1945 Washington post Article on the Luftwaffe Airfield in Oslo and its Forty Long Range Bombers

[Back to Contents](#)

## Chapter 6

### THE STRANGE CASE OF THE DISAPPEARING GENERALS :

SS OBERGRUPPENFUHRER DR.ING.HANS KAMMLER AND GENERAL GEORGE S. PATTON

"Pilsen and the Skoda Works were captured by Combat Command B Third Armored Division, the same unit that captured Kammler's unique metropolis, with its treasure trove of missiles and jet engines, at Nordhausen in Saxony on April 11."

**Tom Agoston,**

*Blunder! How the U.S. Gave Away Nazi Supersecrets to Russia* <sup>1</sup>

<sup>1</sup> Tom Agoston, *Blunder! How the U.S. Gave Away Nazi Supersecrets to Russia* (New York: Dodd, Mead and Company, 1985), p. 65.

World War Two ended in Europe with the armored divisions of U.S. General George S. Patton's Third Army lunging deep into the tottering Third Reich, toward Arnstadt in Thuringia and toward the immense Skoda munitions works at Pilsen, Czechoslovakia. This little appreciated fact links together two of the war's most famous and powerful generals and perhaps affords a basis to speculate on the real reasons for the mysterious death of the one, and the equally mysterious "death" of the other.

The generals in question are General Patton, well-known to military history and America's most famous and capable field commander during the war in Europe, and SS Obergruppenfuhrer Dr. Ing. (doctor of engineering) **Hans Kammler**, now little known to popular history, architect of the infamous Auschwitz death camps, responsible for the demolition of the Warsaw ghetto, and by the end of the war, the Third Reich's plenipotentiary for all secret weapons research, responsible directly to Reichsfuhrer SS Heinrich Himmler and to Adolf Hitler himself.

## A. Introduction: The Rediscovery of the SS Sonderkommando, Kammler, and a Brush with "the Legend"

As previous chapters have indicated, there is some entity within the Third Reich that appears to have coordinated extremely sensitive and secret weapons research projects, including possible oversight of Germany's apparently large uranium enrichment program. However, this entity, as we shall subsequently see, was responsible for a great deal more than that. It is necessary at this juncture to say something about it, however, as it now directly enters the picture in the speculative reconstruction of the strange death of the one, and the disappearance of the other, of these two very important generals.

This entity first came to public light in the aftermath of World War Two, in the 1950s, in a series of publications in West Germany, and in a book by former German major **Rudolf Luser**. These publications alleged that Nazi Germany had created and successfully tested "unusual" aircraft, including flying disks or saucers. Thus was born the "Nazi Legend" of the "real origin" of UFOs. More will be said about this Legend in the subsequent parts of this book. Here it suffices to note that the Nazi Legend maintained that this secretive development occurred under the direct auspices of the SS.

The allegations of an ultra-top secret entity coordinating and controlling the Nazi secret weapons research in the final years of the war tended to be discounted, along with its more sensation component, the "flying saucers" themselves. Moreover, discounting these allegations was easy to do, since they rested upon the isolated testimony of a disenchanted German major with definite Nazi sympathies (Luser) and the "eye witness" statements of one or two others who came forward to corroborate the story, each with their own shady associations.

All that gradually began to change, however, by a sequence of events ranging from the publication of a book by a former British intelligence officer, **Tom Agoston**, in 1985, by the German reunification itself in 1989, which made a host of archives of the former East Germany available to researchers. A number of books has appeared in Germany since the reunification made these archives accessible, and moreover, the formerly inaccessible SS secret underground facilities and complexes finally became accessible to the public. Aided and abetted in their efforts by the declassification of several documents by the Clinton administration in the United States, German researchers began to probe the new information, reconnecting the dots, and presenting a chilling picture of the actual state of Nazi wartime research and its enormous discrepancy with the postwar Allied Legend.

This body of work has been almost entirely ignored in North America.<sup>2</sup> Agoston's work was the first indication from the "mainstream" that there may have been something behind the Nazi Legend. Agoston revealed his story for the first time after his source, none other than close Kammler associate at the famous Skoda Works, Dr. **Wilhelm Voss**, died. The story that Voss told Agoston at the end of the war was, according to Agoston, in confidence.

As Agoston notes rather sarcastically, Kammler boasted almost the perfect "corporate resume" and a documentable record of "whole person management" as a "team player":

A modern day management consultant who was talent hunting for a "total professional with total involvement" would certainly have been fascinated by the bizarre curriculum vitae Kammler could have submitted. He could demonstrate a "track record" in "very senior appointments," with skill in putting across "aggressive growth plans."...

The most prominent post-reunification German sources for this story are Friedrich Georg's series on secret weapons, Hitler's Siegeswaffen series in three volumes; and the studies of Edgar Mayer and Thomas Mehner, *Das Geheimnis der Deutschen Atombombe; Die Atombombe und das Dritte Reich; Hitler un die "Bombe"*; Harald Fath's *1945 -Tthuringens Manhattan Projekt ami Geheime Kommandosache -S III Jonastal und die Seigeswaffenproduktion*.

Also not to be neglected is **Robert K. Wilcox's** *Japan's Secret War: Japan's Race against Time to Build its Own Atomic Bomb*, for the latter book raises the question of where Japan acquired its enrichment capability and stocks of uranium in no uncertain terms (see chapter 7 of this book). Also important is **Karl Heinz Zunneck's** *Geheimtechnologien, Wunderwaffen und die irdischen Facetten des UFO-Phanomens*.

In the the Third Reich, within a span of a few years, the number of positions he had held in turn was phenomenal.<sup>3</sup>

Among these "senior appointments" **Kammler** once commanded were:

(1) Operational control of the V-1 and V-2 terror bombardments of London, Liege, Brussels, Antwerp and Paris;

(2) Operational control of all missile production and research, including the V-2 and the intercontinental ballistic missile. the A9/10;

(3) Design and construction oversight of the world's "first bombproof underground aircraft and missile factory sites," including sites for the production of jet engines and the Messerschmitt 262;

(4) command of the SS Building and Works Division, the department which handled all large construction projects for the Reich, including death camps, "buna factories," and supply roads for invading German legions in Russia;

(5) Design and construction of the world's first underground testing and proving range for missiles;

(6) Command, control and coordination of all of the Third Reich's secret weapons research by the war's end.<sup>4</sup>

This warped and twisted administrative genius first came to the attention of Himmler and Hitler,

"with a brilliant hand-colored design for the Auschwitz concentration camp, which he subsequently built. Later he was called in to advise on the modalities for boosting the daily output of its gas chambers from 10,000 to 60,000."<sup>5</sup>

<sup>3</sup> Tom Agoston, *op. cit.*, p. 5.

<sup>4</sup> Agoston, pp. 5-6.

<sup>5</sup> *Ibid.*, p. 6.

All this is to say that not only was **Kammler** a butcher, but that by the war's end, Hitler had "concentrated more power in Kammler's hands than he had ever entrusted to a single person," bar none.<sup>6</sup> If one were to compare Kammler's position to a similar hypothetical position in the former Soviet Union, such a position would mean that the general who (commanded) the SS-20 rockets in Europe and Asia (the Commander in Chief of Strategic Rocket Forces) would also head research, development, and production of missiles.

In addition, he would be in charge of producing all modern aircraft for the Red Air Force and have overall command of the mammoth civil engineering projects or the production centers in Siberia's sub-zero climate. Last, but very much not least, he would lead the national grid of gulags. To match Kammler's position in the SS, the Soviet general holding all these variegated commands would also be third in the KGB pecking order.<sup>7</sup>

<sup>6</sup> Agoston, *op. cit.*, p. 4.

<sup>7</sup> *Ibid.*, p. 7.

Indeed, one would have to add to Agoston's list, for such a Soviet general would also have had to be in charge of the coordination of all the most post-nuclear and super secret advanced scientific research and black projects in the entire Soviet Union. It is thus in the person of SS Obergruppenfuhrer Hans Kammler that all the lines of our investigation meet: the Buna factory and slave labor of the camps, exploited for grizzly medical experimentation and labor in the secret underground laboratories and production facilities, the atom bomb project, and as will be seen in the subsequent parts of this book, even more horrendous and monstrous aircraft and weapons development.

If there was a gold mine of information, then it was available in the blueprints and files that were locked in Kammler's vaults, or even more securely in his brain. It is this fact and Kammler's extraordinary dossier that make his post-war fate even more problematical. But what of Kammler's "Special SS Command" (Sonderkommando) structure itself? What was it that was so revolutionary that Dr. **Voss** would have required **Agoston** to maintain confidentiality until after his death?

Voss had joined Skoda in 1938, when the plant was ceded to the Reich under the Munich Pact - Hitler, Chamberlain, Mussolini and Daladier, allotting the Sudeten German areas of Czechoslovakia to Germany and became an affiliate of Hitler's principle arms maker Krupp. With his flair for quiet diplomacy, Voss was immensely popular with the Czech executives, who had remained in leading positions at the time of the German takeover of Skoda. Voss even saw to it that Czech workers, paid on the local and not Reich wages, were paid more <sup>8</sup> money.

Also important to the Skoda-SS relationship is the fact that all of Bohemian Czechoslovakia became a "Reich Protectorate," in effect turning total political, administrative, and military control of Bohemia over to the SS. It is in this context that the special relationship between Voss and Kammler developed.

By quirk of fate, the careers of Kammler and Voss overlapped at Skoda, where they jointly set up and operated what was generally regarded by insiders as the Reich's most advanced high-technology military research center. Working as a

totally independent undercover operation for the SS, the center was under the special auspices of Hitler and Himmler. Going outside the scope and field of Skoda's internationally coveted general research and development division, it worked closely with Krupp and was primarily concerned with analysis of captured equipment, including aircraft, and copying or improving the latest technical features. In so doing the SS group was to go beyond the first generation of secret weapons.<sup>9</sup>

8 Agoston, op. cit., p. 11.

9 Ibid., p. 12.

Thus one has the first component of this Special SS Command: the analysis, duplication, and improvement of all recovered foreign and enemy technology. This in itself is not surprising, since all major combatants during the war maintained such research facilities.

The second thing one must note is the careful and deliberate camouflaging of the SS Special Command inside the normal engineering division of the Skoda works. But the real operational goals of this Special command were far more than the mere analysis of captured enemy equipment, as Voss detailed to Agoston.

Its purpose was to pave the way for building nuclear-powered aircraft, working on the application of nuclear energy for propelling missiles and aircraft; laser beams, then still referred to as "death rays"; a variety of homing rockets and to seek other potential areas for high- technology breakthrough. In modern high-tech jargon, the operation would probably be referred to as an "SS research think tank." Some work on second-generation secret weapons, including the application of nuclear propulsion for aircraft and missiles, was already well advanced.<sup>10</sup>

Nuclear powered aircraft would require the development and miniaturization of functioning atomic reactors, something the Germans were not, according to the Allied Legend, supposed to have achieved. And though the mention of lasers seems to stretch one's credulity beyond all reason, there is credible evidence that the Germans were up to just that, and more besides.<sup>11</sup> But the most remarkable thing about this "SS think tank" was that it was established entirely without the knowledge of Goring, Speer, or any of the other big-wigs or research centers in the Reich.<sup>12</sup>

This would not only explain Speer's puzzlement at Jackson's question that we encountered earlier, but would also explain the apparent lack of information on the part of the Farm Hall scientists interred in England after the war. These two facts alone indicate that the SS Special Command headquartered at the Skoda Works in Pilsen was more than just a secret weapons project being run through ordinary channels.

Unlike even its Manhattan Project counterpart, it had no connection to the standard branches of the German military, the German state, or even the Nazi Party; it was entirely off the books. It is, in every sense that we have come to know it, a *Black Project*, coordinating all black projects in Nazi Germany. So extensive was the mandate given to this group that if there was a large uranium enrichment program underway in Germany for the production of atom bombs, then this is the entity most likely coordinating it.<sup>13</sup>

10 Agoston, op. cit., p. 12."

11 Q.v. the remaining parts of this book.

12 Ibid., pp. 12-13.

13 Agoston alludes to the existence and connection of the uranium enrichment program to the Kammler Staff when he states "Even fissile uranium-235 was reportedly made available to Berlin's prime Axis ally.(p. 32)."

While the enormous implications of this statement are obvious, Agoston does not pursue the atom bomb component of the Kammler Staff in his book, Moreover, not only did Skoda's "overtly operating research and development division" work closely with the SS on some less sensitive projects, it,

"provided a convenient cover for the Kammler Staff specialists, culled in great secrecy from Germany's research institutes to supplement the in-house experts. All were picked for their know-how and not for their Party records, Voss said. All had to have the ability to tackle visionary projects. "<sup>14</sup>

The *Kammler Staff Special Command* even circulated top secret scientific paper and memos to the various scientists within the group itself via a central office of scientific reports. Some of these reports were then used as a basis of recruitment of top scientists.<sup>15</sup>

So what was the Kammler Staff, or *Kammlerstab*, as outlined by Voss and Agoston?

First, it was the continuation of "normal" science, free of the constraints of Nazi party ideology, but under the control of the SS! But it was much more. Not only was it a "think tank," but it was also a central clearing house for ideas, for mapping out precise technology trees for the acquisition of second and third generation weapons. But it was more, it was also a fully-funded research Black Programs coordinating office with its own "inexhaustible" and expendable labor pool.

All of it was coordinated by SS General **Hans Kammler**.

All of it was headquartered at the Skoda Works in Pilsen.

And one more thing. By the war's end, Kammler also had control of the Reich's heavy-lift long range transport aircraft, consisting of several Ju 290s and the two enormous Ju 390s, one of which, according to Agoston, made a polar flight to Japan on March 28, 1945,<sup>16</sup> though he surely would have suspected it. The link of the Auschwitz "Buna plant" to the SS via the death camp there already provides one link to Kammler, since the "Buna plant" fell under SS jurisdiction via the camp itself, and thus the connection to Kammler is direct.

14 Agoston, op. cit, p. 13, emphasis added.

15 Ibid., p. 14

16 This fact is merely reported by Agoston without substantiation, leading one to the conclusion that the source of the information must have been Dr. Voss. It is worth noting that Nick Cook reports that Kammler had control of the Ju 390s as part of another SS Special Evacuation Command, which was the

If ever there was a reason for the Allied High Command to by-pass Berlin and head south to central Germany(Thuringia) and for Patton's Third Army to make a beeline for Pilsen and Prague, this was it. Thus, only in the recently revealed context of the existence of the Kammlerstab do any of the Allied or German military deployments or operations at the end of the war make any genuine military sense. The "National Redoubt" story was likely just that, a story put out by the American OSS to force the Allied commanders to change objectives, without disclosing the real nature of their concerns, priorities, and intelligence objectives.

## **B. The Four Deaths of SS Obergruppenfuhrer Dr. Ing. Hans Kammler**

General Kammler, in addition to his "accomplishments" in streamlining death camp efficiency, his methodical and efficient leveling of the ruined Warsaw Ghetto and meticulous accounting of every last brick and stone removed, his coordination of the most arcane, and perhaps the biggest, secret weapons black projects program in human history, has also another odd distinction to his credit. He of all the high-ranking Nazis indicted and tried at Nuremberg either posthumously or in absentia, was never formally indicted, much less brought to trial. He is altogether missing from the docket, and altogether just simply missing.

Kammler has yet another distinction. He appears to have been not only a very accomplished messenger of death for others, but also appears to have achieved the astonishing feat of having died himself no less than four times, each under different circumstances. Agoston commented at length on the odd assortment of "facts" surrounding Kammler's fate: brainchild of none other than Martin Bormann. The purpose of this special command was to evacuate... something. Cook reports that one of these enormous Ju 390s simply went missing at the end of the war.

Analysis of the voluminous documentation (at has accrued since embarked on the first left of the fascinating project in 1949 shows crude discrepancies, the inconsistencies of which grow with almost every addition to the mosaic of information that enters the picture Basically three major facts stand out:

1. In almost four decades, official records show no positive confirmation of Kammler's death. No court of law, no media editor would accept the uncorroborated statement of "unknown comrades," still so referred to in official records as conclusive evidence of death especially if the death was alleged to have taken place in the chaos of collapsing Germany.
2. The record shows no subsequent sworn corroborative statement Such a statement would automatically have been entered in the Red Cross and other dossiers on Kammler.
3. None of the persons reporting any of the four versions of the general's death had conformed with the prescribed duty of all servicemen to detach one-half of a dead man's soldier's paybook or officer's identity document, to the nearest unit, relevant records office, Red Cross, or holding power, if the surviving serviceman had become a



prisoner of war, to help notification of next of kin. Germans are traditionally meticulous and, to say the least, most sentimental in such matters.

Thus, in spite of,

"the proliferation of unsubstantiated evidence that permeates all four versions of Kammler's death, the shell of the case contains sufficient facts to suggest a more than coincidental pattern of seemingly targeted and organized disinformation."<sup>17</sup>

The origin of this disinformation, according to Agoston, was probably within the SS itself, a program necessitated by Kammler's disappearance and likely treason to one of the victorious Allied powers.

The "first death of General Hans Kammler" is recounted by Albert Speer himself, in his last book. In this most simple version, Kammler ordered his adjutant to shoot him. The "suicide" allegedly took place in Prague as Kammler realized the war was lost and, according to Speer, "acted in elitist SS loyalty."<sup>18</sup>

<sup>17</sup> Agoston, *op. cit.*, pp. 102-103, emphasis added.

<sup>18</sup> *Ibid.*, p. 103.

As Agoston quips,

"even the most ardent worshipper of Teutonic creed could not possibly suggest that elitist SS loyalty can be demonstrated three times, in three locations, and all on the same day."<sup>19</sup>

The second version of the story, related to Agoston by Kammler's "civilian" aide Dr. Wilhelm Voss, was that the general took cyanide somewhere "on the road between Pilsen and Prague on May 9."<sup>20</sup>

We will have more to say about Voss's association with Kammler's vast SS secret weapons think tank in due course. The third version of Kammler's death was doled out by V-2 rocket expert, General Walter Dornberger, subsequently employed by the American firm of Bell Aerospace. According to Dornberger, Kammler's mental and emotional state had quickly deteriorated in the final days of the war, and the general overheard Kammler ordering his aide to shoot him if things became "hopeless."<sup>21</sup>

But this does not square with Dornberger's close associate, Dr. Werner Von Braun's own recollection of a conversation he overheard between Kammler and his aide Starck fully two weeks later. According to Von Braun, Kammler and Starck discussed the possibility of "going underground" before the Americans arrived, disguising themselves as monks in a nearby abbey.<sup>22</sup> Thus report, if true, is perhaps the most interesting, since it indicates that Kammler had no intentions of surrendering himself to any of the Allied powers, but rather, intended to survive, perhaps independently continuing his oversight of secret weapons development.

Another version of Kammler's death has him giving a speech to his assembled aides in Prague in early May 1945, dismissing them from their duties and advising them to return home, and then walking into a woods where he then shot himself.<sup>23</sup> And lastly, there is a version of Kammler's death that has him dying a typical SS hero's death, fighting and going down in a blaze of "glory" in the face of rebelling and revolting Czechs.<sup>24</sup>

<sup>19</sup> Agoston, *op. cit.*, p. 104.

<sup>20</sup> *Ibid.*

<sup>21</sup> *Ibid.*, pp. 103-104.

<sup>22</sup> *Ibid.*

<sup>23</sup> *Ibid.*, p. 99.

<sup>24</sup> *Ibid.*, p. 92.

What emerges from all this is that no one, no where can advance anything like a consistent account of the date, location, time, or even method of Kammler's death. Now it is suicide by poison, then suicide by gunshot, suicide by ordering an aide to shoot him, a fighting death, or disappearance into a Roman Catholic monastery. Now he is in Prague, now he isn't; now he's with people, now he isn't; now he's suffering mental and emotional collapse, now he isn't.

In all likelihood, therefore, **Kammler** did not die at all; he disappeared. The important question is, where?

## C. The Ironic Death of General George S. Patton

While Obergruppenfuhrer Kammler was *busy dying four times in various locations by various means*, another general was busy lunging his troops with the precision of a surgeon into the nerve centers of Kammler's black projects empire: General **George S. Patton**. His troops formed the spearhead of the Allied lance that, much to the surprise of the Nazi, Soviet, and Allied field commanders themselves, suddenly turned from its victorious drive on Berlin to a militarily questionable operation designed to take the alleged "Nazi redoubt."

By the spring of 1945, the Redoubt had ballooned to become a major military concern to the Allied High command, "despite the caveats from British and US military intelligence."<sup>25</sup> **Agoston** traces the origin of the "redoubt" theme of the postwar Allied Legend to the USA's *Office of Strategic Services*, or **OSS**, the precursor to the modern day **CIA**. The OSS had apparently not bothered, according to Agoston, to check out the sources of its intelligence or the truthfulness of the "redoubt."<sup>26</sup> The final decision to abandon Berlin as a military objective and drive south toward Thuringia was made by Eisenhower on April 11, 1945.<sup>27</sup>

25 Agoston, op. cit., p. 22.

26 Ibid., p. 23.

27 Ibid., p. 23. A possibility is that Kammler arranged to turn over his secret weapons treasure trove to the OSS in exchange for his life. It could have been arranged by fellow SS General Wolff, already in negotiation with Allen Dulles, OSS station chief in Zurich. If so, then the sudden shift of Allied objectives to south central Germany may have originated from intelligence originating within the Kammlerstab itself. This intelligence would have been easily verifiable by Allies who would naturally have wanted to check its veracity by means of aerial reconnaissance of the installation sites presumably leaked to them by someone in the Kammlerstab.

The date of General Eisenhower's decision is crucial, for it means that the military objective shifted from Berlin toward south central Germany after the alleged atom bomb test at Ohrdruf on March 4, 1945. It is therefore possible that the OSS was in receipt of extremely secret intelligence concerning this weapons program and its centers of production, for Patton drives his troops with unerring accuracy right toward this super-secret installations, many of them underground and carefully camouflaged.

Given the sensitivity of the Manhattan Project within the structure of the Allied command, it is also plausible that the OSS decided not to share this information with the Supreme Allied Command, and proffered the "Redoubt" and "fleeing Nazis" and a transferred German war archives as a cover story to sell the Allied command on a shift of objectives away from Berlin.

If indeed the **OSS** "Redoubt" reports were a component of an OSS psychological operation designed against the Allies' own military command structure, designed to divert Allied military operations to a gold mine of military technology and research, then one and only one general was in a position to know the real, and the whole story about the Redoubt, and what was actually recovered in Thuringia, Pilsen, and Prague, and that was General George S Patton.

Patton, as his troops entered the Skoda works at Pilsen and the underground factories and laboratories at the Three Corners region in Thuringia would have been privy to the top secret reports of his divisional commanders entering these super-secret Reich facilities. Patton would thus have a thorough first hand knowledge of the complete inventory of the Reich's most sensitive black programs. As Agoston himself notes, without seeming to realize the importance of his own observations in the light of post-war events, "the sudden switch in Allied planning.... brought at least one bonanza.

The rapid eastward drive of the US Third Army brought to Kammler's secret metropolis well ahead of the Russians in whose designated zone it lay."<sup>28</sup> The holy grail of all this research were the files and blueprints in the central coordination office of Kammler's black programs think tank inside the Skoda Works at Pilsen. And it is likely that General Patton therefore knew much of the general outlines of this treasure trove and what it portended for future secret weapons development. There is thus a direct and immediate link between General George S. Patton, General Hans Kammler, and the little-known world of top secret weapons research that Kammler headed.<sup>29</sup>

28 Agoston, op. cit., p. 27.

29 This fact is adequately appreciated by Mayer and Mehner, *Das Geheimnis*, p. 156.30 Ladislav Farago, *Patton: Ordeal and Triumph*, pp. 787-794.

And this in turn may lend some credence to those who view General **Patton's** ironic death after the war as being something more than an ironic accident. The factual circumstances of Patton's death are plain enough. While on an inspection tour with his driver and Major General **Hobart Gray** on December 9, 1945, Patton's car swerved to avoid hitting

a heavy US Army transport truck that had turned in front of them. Patton's driver, attention momentarily diverted away from the road by a remark that Patton himself had made, belatedly noticed the truck in front of them, and swerved the General's car to avoid a head-on collision.

None of the others involved in the accident were hurt, and all were able to walk away from the accident. Not so General Patton. He had suffered a broken neck, and the prognosis was paralysis from the neck down. From this point the General recovered rapidly at the military hospital in Frankfurt, making such good progress that until the afternoon of December 19th, his doctors were seriously considering moving him to Boston. But that afternoon his breathing difficulties increased dramatically and suddenly. On December 20th he suffered breathlessness and pallor, and Patton, who had had a prior history of embolism, died in his sleep on December 21st at 5:50 P.M.<sup>30</sup>

The fact that Patton alone of all the victims of the automobile accident suffered serious injuries, plus the lack of his recovery and then sudden decline in a military hospital, have fueled various conspiracy theories. One of these, that Patton knew of the Soviet shooting of American, Canadian, and British prisoners of war and threatened to expose the Allied knowledge and cover-up of the affair, was revealed by a Ukrainian defector with close ties to the Soviet KGB, who alleged that Patton's accident was no accident, and that the KGB had been behind it. Another version is similar, but has the OSS or other Allied entity performing the "accident" and subsequent "medical complications."

If there is any truth in the idea of a conspiracy behind the ironic death of America's most decorated and celebrated general officer of the Second World War, then the explanation is likely to lie in the more esoteric and arcane secrets he and his intelligence officers uncovered in Thuringia and at the Skoda Works in Pilsen. Having performed a preliminary assessment of the second and third generation weaponry Kammler's scientists had begun to research, the OSS specialists who arrived at these sites must have immediately realized the material would require the tightest security and highest classification then possible, beyond that even of the Manhattan Project, not least because what was uncovered would give lie to the emerging Allied Legend of nuclear technological superiority. Patton was a potential threat to the security of this operation and a risk to the continued secret American development of Kammler's technology in conjunction with [Operation Paperclip](#).<sup>31</sup>

<sup>31</sup> It is significant in this respect that Mayer and Mehner report in *Das Geheimnis* (p. 187), that all of the documents of Patton's troops in Ohrdruf are still sealed and classified.

If there is truth to the conspiracy theories of Patton's incongruous death, then of all the theories, this would seem to be the most plausible motivation and explanation for the murder of America's famous general.

Patton, and his famous mouth, had to be silenced.

## D. The Kammler SS Sonderkommando Secret Weapons Empire

Were the secrets of Kammler's SS empire worth changing the entire Allied operational plan at the end of the war, and were they worth the possible deliberate assassination of one of the war's most famous generals?

"Pilsen and the Skoda Works were captured by Combat Command B, Third Armored Division, the same unit that captured Kammler's unique metropolis, with its treasure-trove of missiles and jet engines, at Nordhausen in Saxony on April 11."<sup>32</sup>

Suspiciously, Agoston's Freedom of Information Act request for the war diaries of Patton's armored units that captured the SS facilities in Pilsen and Prague could not be located in the US National Archives.<sup>33</sup>

However, Agoston presents evidence that Allied intelligence, at least from the British point of view, had little to no knowledge of the Kammler Group. British Lieutenant Colonel **James Brierley**, commanding the first British intelligence group to arrive in Pilsen after its capture, stated that the Skoda plant workers and engineers themselves reported that everything was microfilmed, that the buildings which housed their blueprints and development projects had been demolished, and also that the files had been stored outside Pilsen.<sup>34</sup>

<sup>32</sup> Agoston, *op. cit.*, p. 65.

<sup>33</sup> *Ibid.*, p. 70.

<sup>34</sup> *Ibid.*, p. 75.

Destroyed by whom? And stored outside Pilsen by whom? Presumably by the SS itself. It is perhaps pertinent to this idea that many of the reports of Kammler's death place him in the area, not to die, but to remove the most sensitive data and to vouchsafe it for security.

At this point it is necessary to say something about Agoston's own thesis concerning the disappearance of the Kammler Staff's files. The whole thesis of Agoston's book is obvious from its title, i.e., that in the confusion of the transfer of the Skoda Works from American to Russian military occupation, the Kammler Group's entire secret inventory was handed over to the Soviet Union. This much is recounted to Agoston by Voss. However, if Kammler had previously removed, or even duplicated, the most sensitive items, blueprints, and papers and secreted them somewhere, as would seem to be indicated by the Czech reports to British intelligence, then it is likely that all the Soviets received were the table scraps. Kammler had previously removed the most sensitive items, and Patton's men, and presumably the OSS, would have thoroughly scoured the remaining material.

Another possibility thus emerges in the "conspiracy" view of Patton's death. Could he have been assassinated because he himself was the point man to bring Kammler and his secrets and technicians and scientists into the emerging *Operation Paperclip*? While we will probably never know for sure, it is interesting to note that when Dr. **Voss** gave "the full story of the secrets leakage at Pilsen and Kammler's disappearance to US Intelligence in West Germany," he was informed "at the highest level to keep the matter under wraps, along with the briefings he then gave US Intelligence of the areas covered by the SS research at Pilsen."<sup>35</sup> Who was it that debriefed Voss for US military intelligence? None other than fellow general officer Lieutenant General **Lucius D. Clay**, a man well known to Patton.<sup>36</sup>

What happened to Dr. Voss after the war?

Perhaps not unusually, he became involved in a joint *CIA-West German BND* (Bundesnachrichtendienst, West Germany's version of the CIA) effort to build armaments plants for Egypt's Gamel Abdul Nasser, and to train its army. **Voss** became the overall coordinator of an effort to supply Egypt with former Wehrmacht officers and the latest in missile technology. Also involved was former Reichsbank president Hjalmar Schacht, father-in-law to famous SS commando, and later coordinator of the notorious ODESSA (*Organization der Ehemalige SS Angehöriger* or *Organization of Former SS Members*), **Otto Skorzeny**.<sup>37</sup>

<sup>35</sup> Agoston, op. cit., p. 94. Agoston notes that this secrecy order to Voss kept him from disclosing the story until after Voss' death.

<sup>36</sup> Ibid., p. 116.

<sup>37</sup> Ibid., pp. 116-118.

This effort was part of a much broader postwar effort on the part of the West German government to expand its markets for high technology military equipment to the Arab-Muslim world, a drive that has continuing political repercussions down to our own day. There is more than meets the eye in this postwar SS-Arab connection, that will be explored further in the subsequent parts of this book.

In any case, taken together the picture of the postwar behavior and associations of Dr. **Wilhelm Voss**, the multiple "deaths" of Obergruppenführer Kammler, his more likely disappearance into yet another black programs empire, and the ironic if not suspicious death of General George Patton are further corroboration that the Nazi Reich was up to far more than V-1s and V-2s.

It was in the possession of prototypical technologies and military capabilities of such extreme power and sophistication that many of these secrets remain classified. Before we can examine what these secrets might be and the type of physics that they imply, we must, however, take a detour to the other Axis power seeking its own path to the atom bomb on the other side of the world.

[Back to Contents](#)

## Chapter 7

### THE HONORARY ARYAN BROTHERS

"Contrary to the widely held view, the United States may have known about the Japanese project before the end of the war, and this information might have influenced President Harry Truman's decision to use the bomb on Japan."<sup>1</sup>

"... when UN forces had been at Hungnam in connection with the retreat from Chosin, a mysterious installation in the mountains around it had been discovered."<sup>2</sup>

An ancient Japanese legend has it that the Japanese people are descended from a blonde haired blue eyed race that came from the stars, a legend remarkably similar to the doctrines that percolated in the secret societies that fostered and mid-wifed the Nazi Party into existence in Germany between the World Wars. Nor did this legend play a small part in the history of World War Two, for it was partly because of its mere existence that Hitler could proclaim the Japanese "honorary Aryans" and conclude the incorporation of Japan into the Rome-Berlin-Tokyo Axis without contradicting Nazi Party racial ideology.

This was in no small part due to the Japanese ambassador in Berlin's diplomatic skill in pointing out this little known fact of Japanese legends to the Germans. Of course, there were pressing military and political reasons for Italy and Germany to conclude an alliance with Japan, but for the race and ideology obsessed Nazi government, so much the better if the Japanese had some sort of Nordic-Aryan connection, no matter how tenuous that might be. An early and continuous problem for the three Axis partners was to arrange the transfer of technology and raw materials from Europe to the Far East. Most transfers occurred via U-boats or Japanese submarines, though both Germany and Italy undertook long range, and militarily quite risky, flights to Japan as well.

<sup>1</sup> Robert K. Wilcox, *Japan's Secret War: Japan's Race against Time to Build its Own Atomic Bomb*, p. 18.

<sup>2</sup> *Ibid.*, p. 211.

The Italians, for example, mounted such a flight with a Savoia Marchetti S 75 GA during 1942, ostensibly for the purpose of supplying the Italian embassy in Tokyo with copies of new Italian code books, since the Comando Supremo had concluded that the Allies had broken Italian codes.<sup>3</sup> As the war progressed, the Germans found themselves increasingly trading their high technology for very little in return other than the prospect of stiffening Japanese resistance and perhaps drawing American force to the Pacific and lessening pressure on the Reich. And the Japanese, their industry hard-pressed to maintain pace with American and British technological developments, were always very eager, and very specific, in their demands for high technology from their Aryan brethren.

Even the conventional military technology transfers from Germany to Japan are staggering enough. By 1944 Japan had requested and received either working models or full production designs for the following:

- German techniques for manufacturing cartridge steel for large gun barrel linings;
- Finished artillery pieces;
- 105 and 128 mm heavy anti-aircraft (FLAK) guns;
- the 75 and 88 mm field pieces and anti-tank guns;
- the Wurzburg radar system;
- 750 ton submarine pressure hulls;
- the PzKw Via Tiger I tank;
- The Focke Wulfe 190 fighter;
- The Henschel 129 tank-busting aircraft;<sup>4</sup>

<sup>3</sup> Dr. Publio Magini, *Military History Quarterly*, Summer 1993. I am very grateful to Frank Joseph for uncovering and sharing this information with me. The updating of Italian code books would be a pressing enough matter for the Italians to undertake such a flight.

<sup>4</sup> This rather odd-looking twin engine aircraft had a bulbous cupola slung beneath the nose of the main fuselage, in which was mounted a 75mm automatically reloading high velocity anti-tank gun projecting from its nose. It was a deadly and efficient tank-busting airplane used with great effectiveness on the Eastern Front, curiously resembling a similar ground assault aircraft in the modern American arsenal, the A-10 "Warthog."

- The Heinkel He 177 heavy bomber;
- The Messerschmitt 264 long-range Amerikabomber;
- The Messerschmitt 262 jet fighter;
- The Messerschmitt 163 rocket-powered fighter;
- The Lorenz 7H2 bombsight;
- The B/3 and FUG 10 airborne radars; and perhaps significantly,
- Twenty-five pounds of "bomb fuses."<sup>5</sup>

<sup>5</sup> Joseph Mark Scalia, *Germany's Last Mission to Japan: The Failed Voyage of the U-234*, pp. 7-9.

Fortunately for American and Commonwealth forces in the Pacific theater, these weapons never saw full scale production by the Japanese. What is intriguing is the last item. Why bomb fuses? Surely the Japanese, who had been raining bombs all over China, Indochina, Burma, and the Pacific knew how to fuse a conventional bomb. The request suggests that the fuses were of a sophistication beyond the capabilities of Japanese industry. And why a request for heavy bombers so close to the end of the war, at least one of which was reputedly capable of ultra-long-range flight and heavy payload?

## A. Strange Rumors

As with the end of the war in Europe, the end of the Pacific war carried with it the odd rumor or two, some of which managed to appear in short articles in the Western Press, before the curtain of the Allied Legend slammed down to hide their implications from view. **Robert K. Wilcox**, in a book that may well in retrospect be the first book on the German bomb project from a revisionist perspective, Japan's Secret War, revitalized these reports and rumors:

Shortly after World War II had ended, American intelligence in the Pacific received a shocking report: The Japanese, just prior to their surrender, had developed and successfully test-fired an atomic bomb. The project had been housed in or near *Konan* (Japanese name for *Hungnam*), Korea, in the peninsula's North. The war had ended before this weapon could be used, and the plant where it had been made was now in Russian hands.

By the summer of 1946 the report was public. **David Snell**, an agent with the Twenty-fourth Criminal Investigation Detachment in Korea... wrote about it in the Atlanta Constitution following his discharge.<sup>6</sup>

<sup>6</sup> Wilcox, *op. cit.*, p. 15.

Snell's source for the allegation was a Japanese officer returning to Japan. The officer informed him that he had been in charge of security for the project. Snell, paraphrasing the officer in his article, stated:

In a cave in a mountain near Konan men worked, racing against time, in final assembly of "genzai bakudan," Japan's name for the atomic bomb. It was August 10, 1945 (Japanese time), only four days after an atomic bomb flashed in the sky over Hiroshima and five days before Japan surrendered.

To the north, Russian hordes were spilling into Manchuria. Shortly after midnight of that day, a convoy of Japanese trucks moved from the mouth of the cave, past watchful sentries. The trucks wound through valleys, past sleeping farm villages.... In the cool predawn, Japanese scientists and engineers loaded *genzai bakudan* aboard a ship at Konan.

Off the coast, near an islet in the sea of Japan, more frantic preparations were under way. All that day and night, ancient ships, junks and fishing vessels moved into the anchorage.

Before dawn on August 12, a robot launch chugged through the ships at anchor and beached itself on the islet. Its passenger was *genzai bakudan*. A clock ticked.

The observers were 20 miles away. The waiting was difficult and strange to men who had worked relentlessly so long, who knew their job had been completed too late.

The light in the east, where Japan lay, grew brighter. The moment the sun peeped over the sea there was a burst of light at the anchorage, blinding the observers, who wore welder's glasses. The ball of fire was estimated to be 1,000 yards in diameter. A multicolored cloud of vapors boiled toward the heavens, then mushroomed in the atmosphere.

The churn of water and vapor obscured the vessels directly under the burst. Ships and junks on the fringe burned fiercely at anchor.

When the atmosphere cleared slightly the observers could detect several vessels had vanished. *Genzai bakudan* in that moment had matched the brilliance of the rising sun to the east. Japan had perfected and successfully tested an atomic bomb as cataclysmic as those that withered Hiroshima and Nagasaki.<sup>7</sup>

There are a number of things to note about this account. How had Japan, hard-pressed for even conventional military technology, pulled off this feat of testing an atom bomb of the same approximate yield as Hiroshima and Nagasaki?

Where did they get the enriched uranium for the weapon? Moreover, the Japanese had tested their bomb only three days after the plutonium "Fat Man" fell on and obliterated Nagasaki. Small wonder then, that the Japanese cabinet debated whether or not to surrender. This important fact, in conjunction with Wilcox's startling revelations, will serve as the basis for further speculation in a moment. Finally, the test itself suggested that the Japanese envisioned deploying the weapon against naval targets. What possible thoughts may have been going through the Japanese cabinet's surrender debate? Possible clues lie in the nature of the Japanese program itself, and its significant reliance on technology transfers from Germany.

The chief physicist involved in the Japanese project was **Yoshio Nishina**, a "colleague of Niels Bohr."<sup>8</sup> It was Nishina who in fact headed the Japanese army team that investigated Hiroshima after the bombing of that city.<sup>9</sup> The reports of the Japanese test at Konan were a steady source of consternation and mystification to American intelligence units in occupied Japan after the war, for unlike its obsession with the German bomb program, Allied intelligence consistently placed the Japanese far behind, as conducting only theoretical studies, and maintaining that the Japanese "had neither the talent nor the resources to make a bomb."<sup>10</sup>

<sup>7</sup> Wilcox, *op. cit.*, p. 16.

<sup>8</sup> *Ibid.*, p. 17, referencing an article in the January 1978 edition of *Science* magazine.

<sup>9</sup> *Ibid.*

<sup>10</sup> *Ibid.*

Resources Japan may have lacked, but there was no lack of talented physicists who understood bomb physics. In any case the reports caused enough concern for the American occupying forces to send several intelligence teams throughout Japan to destroy its cyclotrons, of which there were no less than five, and presumably more!<sup>11</sup> This curious fact raises a question. What were the Japanese doing with that many cyclotrons? Could they have perhaps been given the secrets of Baron **Manfred Von Ardenne**'s method of mass spectrograph separation and enrichment of uranium 235? Or did the Japanese physicists, like their German and American counterparts, come to the realization that the cyclotron afforded a method for isotope enrichment? Both are possible, and the latter is probable.

<sup>11</sup> Wilcox, *op. cit.*, pp. 17, 192.

## B. Strange Industrial Complexes: Kammler Revisited, Noguchi Style

Further confirmation of a Japanese atom bomb test led Wilcox to connect Nishina to a Japanese industrialist named Noguchi. Searching through American declassified records, Wilcox quickly concluded that,

"subsequent directives in the same boxes ordered reinvestigations in 1947 and 1948 of Japanese wartime atomic research, indicating that (American intelligence) still did not know exactly what had happened. In fact, (it) was continually ordering reinvestigations of Japanese wartime atomic research and discovering new facts at least up until 1949, according to additional documents that I found."<sup>12</sup>

Then Wilcox struck a very rich vein:

Box 3 of Entry 224 yielded a high mark of my two days at Suitland:<sup>13</sup> an interrogation of a former engineer at the Noguchi Konan complex, Otogoro Natsume, conducted on October 31, 1946. "Subject" of the interrogation was listed as "Further questioning the newspaper story about atomic bomb explosion in Korea."

<sup>12</sup> *Ibid.*, p. 222.

<sup>13</sup> "Suitland" is Wilcox's nickname for the US National Archives

In attendance were head(sic) of the Science and Technology Division, Dr. **Harry Kelly**; an interpreter, "T/4 Matsuda," and a "Mr. Donnelly," identified only as "5259 TIC." He apparently was some sort of intelligence officer and, judging from their questions, the interrogators had more information about the Konan-Hungnam story that was in the newspaper.

**Natsume**, a chemical engineer, according to the interrogation, had been imprisoned by the Russians and then released to run a Konan plant until he escaped "on a small sailing boat" in December 1945. He told the investigators he'd heard the rumors about the atomic bomb explosion at Konan but knew nothing about it. According to the transcript, the following exchange then ensued:

**Kelly:** "Did any of the plants have accidents during the war?"

**Donnelly:** "We haven't actually found anything concrete. Last few days we have been talking with people here in and around Tokyo and asking them about report(s) of decomposition of hydrogen peroxide and asking them if they knew about it or which plant it was."

**Kelly:** "Did any of the plants have accidents during the war?"

(Natsume through Matsuda): "There were none."

**Donnelly:** "Ask him if he knows anything about the NZ plant making hydrogen peroxide."

**Matsuda:** "He says that he heard about the factory but it was under the Navy and highly secret. He had never been in it."

**Kelly:** "What was the name of the plant?"

**Matsuda:** "He says just NZ plant."

**Donnelly:** "ask him what NZ plant made and what does NZ mean?"

**Matsuda:** "He doesn't know." A few more questions about the ownership and location of the plant, then:

**Kelly:** "About how many chemists worked up there?"

**Matsuda:** "He says there are so many classes of chemists. Do you mean University Graduate?"

**Kelly:** "yes."

**Matsuda:** "He says that there are two factories under management of this company - one in Konan and one in Honbu. There are about 700 chemists altogether (approximately 300 at Konan)."

In a lengthy exchange, Natsume indicated that most of the scientists, engineers, and workers at Konan were arrested and then later released to go back to work. But six key technical people from NZ, whom he later named, were not released and he had "no idea" what the Russians were doing with them except they were being held in the "secret plant."

**Kelly:** "Has he got any idea as to how we can get these secret plans?"

**Matsuda:** "The six men mentioned are the only ones who knew much about the secret plant."<sup>14</sup>

As we shall see momentarily, perhaps the most significant thing about this interrogation is the date, October 31, 1946. It is also significant that the bulk of the scientists involved appear to have been chemists. Finally, as is apparent from the interrogation, the plant or plants at Konan were of significant size.

So what was the Konan complex? To reconstruct it requires a similar process to that used in examining the German uranium enrichment program. The transcript connects the Konan complex and a Japanese industrialist named Noguchi.

**Jun Noguchi** had built the huge Japanese complex of factories that nestled about the Yalu, Chosin, and Fusen rivers. The latter two rivers had been dammed by Noguchi to supply the enormous electrical power needed by his factories. "Together the three rivers delivered more than 1 million kilowatts of power" to the complex.<sup>15</sup> This was for the time a prodigious amount of electricity, especially in view of the fact that all of Japan produced no more than 3 million.<sup>16</sup> Begun in 1926 in a deal struck with the Japanese Army Noguchi's Konan empire expanded along with Japan's imperial appetites.

So, like the I.G. Farben "Buna" plant at Auschwitz, we note already two key ingredients are present at Konan: large electrical power production infrastructure, and proximity to large amounts of water. Konan, in fact, was the largest industrial complex in all of Asia, and relatively sheltered and even unknown to Allied bomber and the intelligence committees that prepared their targets lists.<sup>17</sup> But there is more.

Declassified documents noted that Konan was also near uranium ore deposits.



"This was the logical place for an end-of-the-war atomic bomb project."<sup>18</sup>

<sup>14</sup> Wilcox, *op. cit.*, pp. 222-224.

<sup>15</sup> Wilcox, *op. cit.*, p.63.

<sup>16</sup> *Ibid.*

<sup>17</sup> *Ibid.*, p. 27.

<sup>18</sup> *Ibid.*

Moreover, as **Wilcox** discovered, "More digging...turned up a lengthier summary."

Dated May 21, 1946 and originating within the US Army's chief of staff office in South Korea, it stated:

Of increasing interest have been recent reports dealing with an apparent undercover research laboratory operated by the Japanese ... at ... Hungnam.... All reports agree that research and experiments on atomic energy were conducted.... The two chief scientists were Takahashi, Rikizo and Wakabayashi, Tadashi.... The recent whereabouts of these two individuals is not known, inasmuch as they were taken into custody by the Russians last fall.

However, before their capture they are reported to have burned their papers and destroyed their laboratory equipment.... Some reports... say... the Russians were able to remove some of the machinery. Further reports stated that the actual experiments on atomic energy were conducted in Japan, and the Hungnam plant was opened for the development of the practical application of atomic energy to a bomb or other military use. This section of the ... plant ... was always heavily guarded.... These reports received separately are surprisingly uniform as to content. It is felt that a great deal of credence should be attached to these reports as summarized.<sup>19</sup>

<sup>19</sup> Wilcox, *op. cit.*, p. 28.

We may now speculate as to the real significance of these US Army intelligence reports in the light of subsequent events.

Clearly, the US Army is taking seriously allegations of a Japanese atom bomb project based in the northern Korean Peninsula, very close in fact, to the international border with China, and scene of one of the Korean War's bloodiest battles. At the Chosin Reservoir, General of the Armies **Douglas MacArthur** had been dealt a significant defeat and was forced to retreat.

Indeed, after his celebrated landing at Inchon, MacArthur had relentlessly driven his troops northward in a classic blitzkrieg style campaign, designed in part to seize the Yalu River crossings, crucial to any further operations in China, as well as for defense against any Chinese invasion of the peninsula. And the Chosin Reservoir, and hence Noguchi's vast Konan complex, was also a prime military target. With MacArthur's insubordination and the subsequent Chinese entry into the war, Truman fired MacArthur. So goes the standard history.

But could the real motivations for MacArthur's lightning dash up the peninsula toward Chosin alter the Inchon landings in fact have been based on a very different, and highly secret, agenda of military objectives? Given the US Army's own intelligence memoranda concerning the Konan complex and Russian activities it seems all too likely. And this in turn may mean that the real motivations for his subsequent firing by **Truman** may also lie in what he uncovered there: certain knowledge of the extent, capabilities, and actual achievements of the Japanese scientists and engineers working on the *genzai bakudan*.

But what would have been so sensitive about the Japanese atom bomb project, beyond its actual achievements? To answer this question, we must speculate once again. What isotope separation and enrichment methods were known to the Japanese? What did physicist **Nishina** and his team of scientists finally rely on? Like their German counterparts, the Japanese knew that the ultra-centrifuge was the simplest path, at least in theory, toward the uranium bomb. But Japanese scientists calculated the needed revolutions-per-minute of such a device to be between 100,000 and 150,000 rpms. The United States itself, because of the difficulties in designing turbines of this speed, decided to forego enrichment via this <sup>20</sup> process.

At this point, Wilcox's reconstruction begins to run into a bit of trouble, for the Japanese, he reports, were able to design, and apparently to build, a large ultra-centrifuge.<sup>21</sup>

<sup>20</sup> Wilcox, *op. cit.*, p. 119.

<sup>21</sup> *Ibid.*, p. 120.

Their only problem, according to Wilcox, was a large enough supply of uranium. However, there is a significant weakness in this construction, for the Japanese, it will be recalled, had to request German assistance in the design and production of jet engines, a request that led not only to the exchange of blueprints for the Messerschmitt 262, the world's first operational jet fighter, but of technicians able to show the Japanese the necessary production methods and tolerances to construct such high speed turbines operating under the stress of tremendous heat. In other words, while Japanese theoretical capabilities were not lacking at that time, they did lack certain industrial expertise which only the Germans possessed. Moreover, as we have already seen, the centrifuge idea had originated and been developed by the Germans. So if the Japanese successfully designed and built a large ultra-centrifuge, it would seem likely that German assistance was involved at some point.

The other method, a cheaper method and certainly one well within Japanese wartime industrial capability, and one taken to extremely large size by them, was very much a German device.

What the Nishina group finally did settle on was a process called thermal diffusion. This had been one of the first isotope separation processes devised. But until it was perfected by two German scientists, **Klaus Clusius** and **Gerhard Dickel**, in 1938, it had not been practical. Stated simply, thermal diffusion relied on the fact that light gas moves toward heat. Clusius and Dickel constructed a simple device consisting chiefly of two metal tubes placed one inside the other. The inner tube was heated; the outer one was cooled. When the apparatus was turned on, the lighter U-235 moved to the heat wall; the U-238, to the cold wall. Convex currents created by this movement sent the U-235 upward; the U-238 downward.... At a certain point the U-235 at the top could be collected, and new gas pumped in. It was a simple and rapid way to get relatively large concentrations of U-235.<sup>22</sup>

<sup>22</sup> Wilcox, *op. cit.*, p. 95.

As Wilcox notes, this process, developed as it was in Germany, gave the Japanese access to the latest development of this simple and unusual technology. And as we have already seen, the Germans also deliberately fabricated an alloy - Bondur - to offset the highly corrosive effects of uranium gas.

Used in large size and enough quantity - At Auschwitz and Konan - and perhaps in conjunction with other technologies of enrichment, Von Ardenne's mass spectrograph adaptations of cyclotrons, it is entirely feasible that the Japanese also had a highly secret uranium enrichment project being run near the Konan complex.

So one may advance the line of speculation further: with the surrender of the U-234 and its cargo of infrared proximity fuses and their inventor, **Heinz Schlicke**, and Japan's own request for "fuses" and plans for German strategic heavy bombers, MacArthur's troops at the Chosin Reservoir may have uncovered not only evidence of Japanese progress and eventual testing of a uranium atomic bomb but they may have uncovered further evidence of the success of the program that lay behind it: Nazi Germany's. Indeed, the fuses point to a possible plutonium bomb project underway in both countries.

And so we return to the decision of the Japanese cabinet, and speculate further. If the Japanese government knew of the German program, they may also have known of the extent of its success. Two bombs had fallen, and according to the translator for Marshal **Rodion Malinovsky**, another had fallen but not detonated. In any case, the Japanese were probably aware that while America's single bomb project may not have been capable of delivering more bombs within a short span of time, there would have been no way to estimate how many bombs might have been taken as war booty from the Germans.

And the failure of the U-234's mission would have told them that at the minimum, fuses capable of use in a plutonium bomb as well as a large supply of enriched uranium had fallen into Allied hands. By August 12, 1945, with the successful test of the Japanese bomb and the German test of October 1944, the war had gone nuclear.

Thus, if the Japanese had been informed of the successful test of the German atom bomb in October of 1944, then the debate of the Imperial Cabinet in Tokyo is understandable. Japan was faced with a potential rain of atom bombs "of German provenance," to quote Oppenheimer's curious remark once again. Surrender, *ganzai bakudan* notwithstanding, was the logical choice, even for a nation steeped in "proud samurai traditions of honor."

Perhaps it is significant, in the light of contemporary problems with a nuclear North Korea, that the Japanese government issued a strong warning to North Korea that it could arm itself to the teeth with nuclear and thermonuclear weapons in a heartbeat, and would not hesitate to do so if threatened.

In this light, perhaps the most significant fact uncovered by Wilcox is that,

"contrary to the conventional military history that Japanese atomic efforts were bombed into extinction by spring 1945... the project was continued and heightened even after the Emperor's August 15 surrender."<sup>23</sup>

<sup>23</sup> Wilcox, op. cit., p. 239.

**Wilcox** does not elaborate much farther than this, but the statement raises a chilling prospect:

How could a Japanese project survive right under the noses of the occupying American forces? ... and what if it was not only the Japanese project that survived?

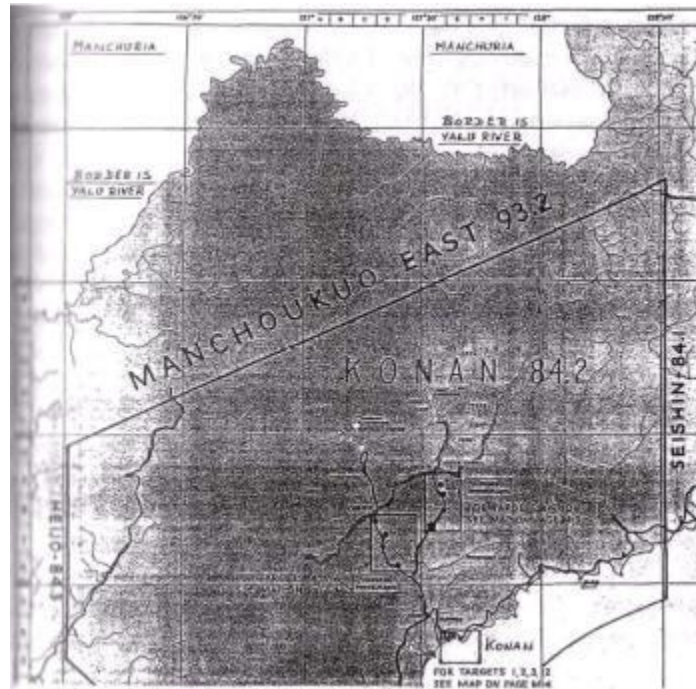

The Konan (Chosin)Region of North Korea

[Back to Contents](#)

## Chapter 8

### THE HEERESWAFFENAMT AND HOUTERMANS MEMORANDA

"And there is something else interesting: Erwin K. Oppenheimer maintained that the bomb that was dropped on Japan was of German provenance. "

**Edgar Mayer and Thomas Mehner**  
Das Geheimnis der deutschen Atombombe <sup>1</sup>

<sup>1</sup> Edgar Mayer and Thomas Mehner, Das Geheimnis der deutschen Atombombe: Gewann Hitlers Wissenschaftler den nuklearen Wettlauf doch? Die Geheimprojekte bei Innsbruck, im Raum Jonastal bei Arnstadt und in Prague, p. 122.

One of the most problematical documents to explain from the standpoint of the postwar Allied Legend is the top secret memorandum concerning the development of an atom bomb anonymously submitted to the German Army Ordnance Bureau (Heereswaffenamt) in early 1942. This document not only correctly estimated the critical mass for a uranium-235 based bomb, but also indicated the possibility of transmutation of uranium into plutonium - called "Element 94" by the memorandum - and its use in a bomb.

The memorandum's origin and authorship has been attributed to various interred Farm hall scientists, including Dr. Kurt Diebner. But the authorship is unknown, and the problem of its existence remains: How could the German army, knowing that the required amount of uranium for a nuclear bomb was comparatively small and therefore technically feasible, not have pursued its development? And how could they have pursued such laughably pathetic attempts toward a functioning

reactor? The mystery only deepens when we consider a possible ancestry for the Heereswaffenamt memo written in a paper the previous year.

In 1941, Baron **Manfred Von Ardenne** decided to circulate an unusual paper by his colleague Dr. **Fritz Houtermans**. The full title of the paper was "*On the Question of the Release of Nuclear chain reactions, by Fritz G. Houtermans: A Communication from the Laboratory of Manfred Von Ardenne, Berlin-Lichterfelde-Ost.*"<sup>2</sup>

The paper is remarkable in several respects, not the least for its revealing table of contents:

- I. General Point of View
- II. Competing Processes
- III. Chain Reactions through Nuclear Fission with Fast Neutrons
- IV. Nuclear Fission through Thermal Neutrons
  1. Isotope Separation
  2. Selection of a heavy Moderator Substance such as Hydrogen, especially Heavy Water
  3. Relative Advance of the Probability for  $1/v$  Process through Application of Low Temperatures
  4. Self-Regulating reaction and the Significance of the Doppler Effect at Low Temperatures
- V. Chain Reactions at Final Trial Volumes
- VI. The Importance of a Chain Reaction at Low Temperatures as a Neutron Source as an Apparatus for Isotope Transformation<sup>3</sup>

<sup>2</sup> Thomas Powers, *Heisenberg's War*, p. 112. The table of contents page of the original memorandum may be found in Mayer and Mehner, *Das Geheimnis*, p. 33.

<sup>3</sup> *Ibid.*, p. 32.

The general outline suggests that Houtermans had already thought his way through the process, not only of initiating nuclear explosions via fast neutrons, but also of the transformation of U235 into higher elements not chemically identifiable with it. This is the first step toward plutonium, and to the use of plutonium rather than U235 as the explosive fuel for a bomb. The contents of the paper confirms that this is what Houtermans has figured out in no uncertain terms:

We are able to envision here an apparatus, that would allow...a certain amount of U235 to undergo nuclear reaction, simultaneously as an isotope transforming apparatus. The advantage vis-a-vis an isotope enrichment apparatus is therefore that the newly-created product, which would have an atomic number of 93 or more, is not chemically identical with uranium, and therefore is separable by chemical methods. Now since much larger amounts, namely 139 times more, of U238 are available, so the amount that would be convertible as fuel for a chain reaction is, from the standpoint of our theme, much more important than isotope separation that would result in mere U235.<sup>4</sup>

<sup>4</sup> Mayer and Mehner, *Das Geheimnis*, p. 32.

In other words, before the 1942 *Heereswaffenamt memo* (which not only gave a critical mass of a bomb with U235 as the explosive fuel that is within the range of accuracy, but which also indicates the transformation of uranium into plutonium in a reactor as an alternative fuel returning more bang for the Reichsmark) Houtermans has clearly seen another path to the atom bomb. He may therefore also be considered a leading candidate, if not the leading candidate, for the authorship of the anonymous *Heereswaffenamt memorandum*. His Jewish background would explain why the memorandum was authored anonymously.

So, having speculated in previous pages that Nazi Germany had actually pursued a uranium bomb as the primary component of its bomb, and conducted a large and very secret uranium enrichment project in order to acquire it, we now come to the subject of the possibility of a plutonium bomb project, conducted once again in secret, and far from the "public exposure" laboratory tinkering of the Farm Hall scientists. In this respect there has already been one indication: the allegation of a second nuclear test of a bomb with a very small critical mass via the process of boosted fission, near the Three Corners region of Thuringia, an area that has the highest gamma background radiation in all of Germany.

Are there corroborating indications that the Germans might have successfully developed an atomic reactor, and hence, plutonium, in the secret recesses of Kammler's SS black programs secret weapons empire? Henry Picker, in his book *Hitler's Table Talk*, makes one significant statement. Not only does he indicate that the Reichspost had something to do with the atom bomb project, but he offers more detail. The bomb was to be constructed in a plant "in an underground SS factory in the southern Harz mountains, which had a foreseen production capacity of 30,000 workers."<sup>5</sup>

Once again, the trail leads back to the SS, the southern Harz mountains of Thuringia, and large underground factories. This facility, according to **Picker**, "was transferred back to the USSR by the Red Army" after the German surrender.<sup>6</sup> According to Picker, it was for this reason that Stalin reacted with such detachment when President Truman informed him

of the successful test of the plutonium bomb at the Trinity site in New Mexico, for Stalin had already acquired the necessary technology to make his own atom bomb. Moreover, Stalin awarded Manfred Von Ardenne the "Soviet 'Nobel Prize,' the Stalin Prize."<sup>7</sup>

Mayer and Mehner comment on the real significance of this series of admissions:

Everything clear? The Russians thus came into possession of some means of production - which from then until now remains unknown -and paid off Manfred Von Ardenne, who was certainly the best consultant in these things, who must have clarified for them the things the Russians had found there.<sup>8</sup>

It is an intriguing idea, for we have already discovered a possible plutonium bomb detonation near Ohrdruf very late in the war.<sup>9</sup> This would of necessity imply that the Germans had acquired a successful atomic reactor, the question is, where? In any case, the reason for lack of knowledge about this project is clear: it was in the control of the SS, and therefore, within the portfolio of the security-obsessed **General Kammler**.

<sup>5</sup> Henry Picker, *Hitler's Tischgesprachen im Fuhrerhauptquartier*, 2 Auflage (Berlin: Propylaen taschenbuch bei Ullstein, 1997), cited in Mayer and Mehner, *Das Geheimnis*, p. 34.

<sup>6</sup> Ibid.

<sup>7</sup> Mayer and Mehner, *Das Geheimnis*, p. 34, citing Picker.

<sup>8</sup> Ibid.

<sup>9</sup> Uranium could of course have been used in a boosted fission device, but the process works better with plutonium, and plutonium would more likely account for such a small critical mass as was reported, namely, 100 grams, since more than that would have been necessary for a uranium bomb even with boosted fission.

In any case, Houtermans' reactor concept was significantly different than Heisenberg's, or for that matter, even **Enrico Fermi's** successful atomic pile at the University of Chicago, since it aimed at the production not of energy, but of radioactive isotopes. For this reason, it would be able to operate at low temperature using liquid methane as a moderator, rather than heavy water or graphite. This meant that it would be an efficient producer of "element 93 or higher" that could be chemically separated and used as a nuclear explosive.<sup>10</sup>

This is significant, for it differentiates the Von Ardenne-Houtermans effort both from the Heisenberg effort to design and construct a working atomic pile, and from Enrico Fermi's success in doing so.<sup>11</sup>

<sup>10</sup> Rose, *op. cit.*, p. 141.

<sup>11</sup> Researcher Frank Joseph has found another source for a reactor, and consider his information to be so crucial to this story, and so sensational, that cannot in good conscience mention it in this work. I believe that it is a story that he best tells himself, since it is his discovery. He was kind enough to share it with me as this book was being written.

So at one end of the war, ca. 1945, we find the allegations on tested weapon of small critical mass which, if true, is most liked that of a plutonium bomb using a process of boosted fission, and at the other end, ca. 1941, we have a paper outlining a project to achieve a reactor for the production of the explosive fuel of such a bomb. There is an odd piece of corroboration that the Germans may also have been perilously close to, if not in actual possession of, a plutonium atom bomb, from the Pacific Theater and the Japanese program.

**Robert Wilcox**, in his *Japan's Secret War*, recounts how the Spanish Nationalist government successfully ran a spy ring both for the Germans and for the Japanese, an espionage operation that had no little success in penetrating the Manhattan Project, even to the extent of acquiring in 1943 the earliest Allied designs for a detonator for such a bomb. Interviewing Angel Alcazar de Velasco, the alleged head of the ring, Wilcox quotes a rather astonishing statement:

The information was that the American work on a nuclear weapon was very advanced but they had a long way to go. There were even notes about the detonator. It was similar to one already in use by the Germans.<sup>12</sup>

A complicated detonator - presumably for use in a plutonium bomb, since the detonator mechanism for a uranium bomb is a much simpler piece of equipment - already in use by the Germans in 1943!? Why would the Germans have had the need for such a complex detonator? The timing of the allegation is also disturbing, since it corroborates the assertions, examined earlier, of the Japanese military attaché in Stockholm, that the Germans were using some type of weapon of mass destruction on the Eastern Front ca. 1943, in the region of Kursk.<sup>13</sup> But Houtermans was interested in more than just atom bombs.

Even **Paul Lawrence Rose** admits that Houtermans' role in Nazi atom bomb research "remains enigmatic."<sup>14</sup> The reason why, though, is clear enough, once its enormous implications are understood, for Houtermans' real specialty lay in the first

theoretical description of the process of thermonuclear fusion of heavy hydrogen (deuterium and tritium) atoms through high heat in stars, the very heat produced by an uncontrolled chain reaction.<sup>15</sup>

12 Wilcox, op. cit., p. 28, emphasis added.

13 The attache, it will be recalled, actually maintained that these weapons - whatever they were - were also used in the "Crimea", making it most likely during the siege of the Russian fortress of Sevastopol in 1942. Thus would seem to weigh very heavily against this mystery weapon being an atom bomb. But if not, what other weapon could have caused such destruction? This is a question that will be more fully addressed in subsequent parts of this book. Powers notes that Allen Dulles in Zurich received reports of a German project in "vast underground factories" that were after "putting out a new explosive in aerial bombs. He has even heard that the container of the explosive is spherical." (Rose, op. cit., p. 272, emphasis added) A spherical detonator, of course, is the type of implosion-compression detonator used to assemble the critical mass of a plutonium bomb.

14 Rose, op. cit., p. 51, n. 38.

15 Q.v. Powers, Heisenberg's War.

With this, we are a step closer to unlocking the riddle of just exactly what types of weapons Kammler's "think tank" was working on, for if Hotelmans' idea was seized upon, then hydrogen bombs would have been the next logical progression in the "technology tree" from the atom bomb, just as it was for the Americans and Russians after the war. Is there any indication the this was in fact the real ultimate goal of the secret German SS atom bomb program? In other words, was it really an atom bomb program at all? Or was it a hydrogen bomb program?

Fantastic as it may be to believe, the latter possibility would seem to be the actual case. The letter of Professor **Lachner** referred to previously also gives further illumination on the goal of Kammler's SS Sonderkommando:

Work was also conducted on the hydrogen bomb. A factory for the manufacture of heavy hydrogen was constructed in Norway but was of course destroyed by the enemy. The small uranium bombs were primarily intended as detonators for the hydrogen bombs, so their immediate use was not contemplated.<sup>16</sup>

Another corroboration for this astonishing assertion may be found in a pre-war Austrian patent for a "molecular bomb", an early version of the hydrogen bomb, from 1938.<sup>17</sup> In any case, Professor **Lachner** asserts unequivocally that the real goal of the project was weapon more terrifying and destructive than the atom bomb.

Another factor is worth mentioning in this regard. The pursuit of the hydrogen bomb would also explain why the Nazis were interested in small atom bombs, made smaller via boosted fission, for a hydrogen bomb, at least with the technology available back then, would have been an enormously heavy and cumbersome object. The quest for "miniaturization" was therefore another practical aim: any such bomb would have to be made small enough for German bombers or rockets to carry, and even then, only the very largest bombers or rockets would have been up to the task, if at all.<sup>18</sup>

16 Mayer and Mehner, Das Geheimnis, p. 80.

17 Ibid., pp. 255-256.

18 It should be recalled that the first hydrogen bomb, America's "Mike", weighed several tons, and was impractical as an actual weapon. America's first operational hydrogen bomb actually weighed several tons. It is difficult to imagine any existing aircraft in the German arsenal, not even the enormous Ju 390, as being up to the task of delivering a hydrogen bomb, and the specifications for the A9/10 Amerikaraket are far below what would be needed bomb, it (or they) were seldom if ever actually used, being husbanded as detonators for something far more powerful? Does this also explain, in part, the real reason for the curtain of secrecy that fell over Kammler's special SS "think tank" command structure?

But to produce hydrogen bombs, one must have an adequate supply of the heavy hydrogen isotopes deuterium and tritium. Here again, however, the Allied Legend intervenes, and maintains that after the successful Allied destruction of the Norwegian heavy water plant at Ryukon, German production of the precious destructive substance was never able to recover, and, as a consequence, heavy water for a moderator in reactors (much less a hydrogen bomb!) was never in enough supply.

The further implication of this assertion is, of course, that the failure of Heisenberg and other scientists to construct a reactor based on heavy water as a moderator was doomed to failure because of the lack of supply. But again, the reality was quite different. Dr. **Diebner** in an exchange with Dr. **Wirtz** - both later interred at Farm Hall - indicated that a complete heavy water plant was built in Germany by the end of 1943.<sup>19</sup> However, revelations made at the end of the war were even more important as a means of measuring the truly significant extent of German heavy water production: a large heavy water factory, hitherto entirely unknown, had been discovered by the Allies in Kiel in northern Germany.

But most importantly, after the German reunification in 1989, when the vast SS underground factories in the Harz region of Thuringia in the former eastern zone were rediscovered, many of these were found to contain several large electrical generators, enough to supply power for a few small cities!<sup>20</sup>

Such high electrical output would certainly not have been needed for the last Fuhrer Headquarters, but it certainly would have been required for factories separating uranium isotope (especially if they used Von Ardenne's cyclotron process), and that manufactured heavy water. Was the hydrogen bomb the real goal? Does this explain the reason that, if Germany did have the atom for such a bomb. The only practical method of delivering a hydrogen bomb, it seems to me, would have been via a large submarine or ship to a port city, a militarily quite risky venture, and one that, for the German crews involved, would have been a one way venture.

19 Mayer and Mehner, *Das Geheimnis*, p. 197.

20 *Ibid.*, p. 198.

One indication that this may be so were remarks made by Dr. **Josef Gobbels** to the Italian officer **Luigi Romersa** who witnessed the Rugen atom bomb test, whom we encountered earlier. According to Romersa, Gobbels told him,

"Heavy water is an important material in the manufacture of the disintegration bomb.<sup>21</sup> We had already before the war made some headway in the direction..."<sup>22</sup>

Headway indeed, if an Austrian patent for prototype had already been taken out in 1938!<sup>23</sup>

21 *Auflosungsbombe*.

22 Mayer and Mehner, *Das Geheimnis*, p. 102.

23 Such a patent would have been immediately classified as a "Geheime Reichsache" or "secret state matter", i.e., a matter of national security as would now be said. As such, it would have definitely made its way directly to Kammler's "think tank," as will be seen in subsequent parts of this book.

That the ultimate goal of the German atom bomb project was the hydrogen bomb, and not the atom bomb at all, seems in retrospect both quite logical and quite disconcerting. As we shall discover in the remaining parts of this book, however, even hydrogen bombs pale by comparison not only just to the "paper projects" being studied in Kammler's SS Sonderkommando, but to the very real projects and experiments with forces of even larger potential destructive capability than hydrogen bombs. Having foreseen the thermonuclear future, the SS was already planning and experimenting with countermeasures, and with second and third generations of offensive strategic weapons even more horrifying.

#### The Allied Discovery of a Heavy Water Plant in Kiel after the end of the War

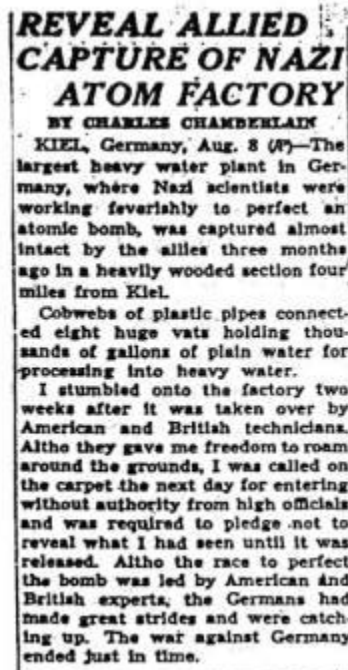

[Back to Contents](#)

## Chapter 9

# POSSENSPIEL BEI FARM HALL AND OTHER FARCES

"Bagge in Berlin and Clusius and Dickel in Munich developed isotope separation methods but achieved little practical success. They never obtained enough  $U^{235}$  to make the proper measurements and certainly too little for a bomb."

### David Cassidy

"Introduction," *Hitler's Uranium Club* <sup>1</sup>

The transcripts of the German scientists interred at Farm Hall seem like a microcosm of Nazi German culture itself, simultaneously charming and paranoid, moralizing and utterly amoral, suffused with brilliant subtlety and ham-fisted bluntness. In view of the thesis that has been examined throughout the previous pages, the Farm Hall transcripts also reveal an equal schizophrenic on the part of commentators ever since their declassification in the early 1990s by the British government.

Consider for example the following remark by Jeremy Bernstein with regard to **Samuel Goudsmit's** "ALSOS" mission to Germany at the end of the war,

"As the mission progressed, and the Alsos team learned more and more about the paucity of the German program, the concern focused on not letting the Russians get at the Germans and so glean 'any major bomb secrets.'" <sup>2</sup>

If the German bomb program was in a state characterized as "paucity," and if there were fundamental "problems" in Heisenberg's understanding of nuclear fission and bomb physics - as there indeed were - then why the concern at all? But then early on in the transcripts an exchange between Heisenberg, Diebner, and Korsching occurs, in which the three German scientists discuss the possibility that they may have been viewed by the Allies and Soviets at Potsdam as war booty.

<sup>1</sup> David Cassidy, "Introduction," in Jeremy Bernstein, ed., *Hitler's Uranium Club: The Secret Recordings at Farm Hall, Second Edition*, (New York: Copernicus, 2001), p. xxix.

<sup>2</sup> Bernstein, *op. cit.*, p. 47.

Bernstein then comments,

"presumably Heisenberg is worried here about being taken to task in German for failing to build a bomb. The notion that these ten German scientists would be discussed at the Potsdam Conference borders on the ludicrous." <sup>3</sup>

If so ludicrous, then why inter them for months, secretly record their conversations and transcribe them, and then keep them classified until the early 1990s? Clearly it would seem that something more is going on at Farm Hall that either eludes commentators, or that they are simply ignoring. The conversations proceed among the ten scientists, with one concern (prior to the announcement of the a-bombing of Hiroshima) being how to continue with their "work", totally oblivious to the fact that others had indeed carried on their "work" to brilliant conclusion. <sup>4</sup>

The schizophrenia grows whenever the subject of isotope separation comes up in conversation. In the epigraph that began this chapter, reference is made to the Clusius tube "thermal diffusion" method perfected by Clusius and Dickel:

"Bagge in Berlin and Clusius and Dickel in Munich developed isotope separation methods but achieved little practical success. They never obtained enough  $U^{235}$  to make the proper measurements and certainly too little for a bomb." <sup>5</sup>

However, in the transcripts themselves, Heisenberg remarks that one reason he and his fellow scientists were interred was that the Allies did not "want us to pass on our knowledge to other people." <sup>6</sup> However it is the editorial comment of this remark that really intrigues; the Germans, notes Bernstein, would have had little knowledge "that would have been of any use to the Allies," but a great deal of expertise that they would have wanted to keep from the hands of other powers such as France and Russia. Then follows another remark concerning Harteck's "ultra-centrifuge" technology, which "would have been an extraordinarily useful thing for any country to possess." <sup>7</sup>

<sup>3</sup> Bernstein, *op. cit.*, p. 81, n. 16.

<sup>4</sup> *Ibid.*, pp. 82-84.



5 Ibid., Cassidy, "Introduction," p. xxix.

6 Ibid., p. 91, the conversation is between Heisenberg, Von Weizsacker, Wirtz, Harteck and Diebner on July 18, 1945.

7 Ibid., p. 91, n. 7.

Indeed, this was a technology that even the US and UK had not brought to such an advanced state of perfection.

And then, on July 26, 1945, a remark is made by **Otto Hahn** that only increases the mystery:

"I read an article in the Picture Post about the uranium bomb; it said that the newspapers had mentioned that such a bomb was being made in Germany. Now you can understand that we are being 'detained' because we are such men."<sup>8</sup>

The editorial comment only increases the problem:

"This was before the bomb was used on Japan, when its existence was kept in strict secrecy!"<sup>9</sup>

Had Hahn unwittingly let the cat out of the box? It is an odd thing for a scientist of Hahn's stature to say, especially since, as we have seen, there were a wealth of "indications" of the size of the German project that appeared in short articles in the Allied press both during and after the war.

Then on July 21, 1945, the handsome and cynical Horst Korsching, discussing the prospects for making a living with Diebner and Bagge, offers a curious observation:

BAGGE: For the sake of the money, I should like to work on the uranium engine; on the other hand, I should like to work on cosmic rays. I feel like Diebner about this.

KORSCHING: Would you both like to construct a uranium engine?

DIEBNER: This is the chance to earn a living.

KORSCHING: Every layman can see that these ideas are exceedingly important. Hence there won't be any money in it. You only make money on ideas which have escaped the general public. If you invent something like artificial rubies for the watch making industry, you will make more money than with the uranium engine.<sup>10</sup>

8 Bernstein, *op. cit.*, p. 94.

9 Ibid., n. 19.

10 Ibid., p. 99.

Artificial rubies? Of course, such things were used in watch making before the invention of quartz movement. But in 1945, the idea was fantastic. Of course, by the time of the declassification of these transcripts, the world's first laser, which did in fact use an artificial ruby as the main component of the lasing optical cavity, was history, having been invented in 1961. But in July of 1945 the idea was more than a little ahead of its time. Is this another possible, though slight, indication that something else was going on inside Nazi Germany?

Later in the conversation, **Korsching** expresses his desire to return to Hechingen to collect his telescope, lenses and prisms, an indication that he was perhaps involved in optical as well as nuclear research. But then, another curious statement from Korsching:

Of course it would be an idea to go to the Argentine with two people and say: "Here we are, we know how to do this and that; we have a good method for the separation of isotopes, we do not need to produce heavy water." Somehow in this fashion we have to do it. It would not come to anything if you collaborated with Heisenberg on a uranium engine. They did not even bring along the small fry to this place, that is how outsiders judge the work.<sup>11</sup>

If the thesis presented thus far is true, and there was a very secretive SS bomb project and if the Heisenberg represented a false front "sham" project being deliberately shut out of the loop by the SS and maintained for Allied consumption, then indeed there may be other motivations for the internment of the German scientists than are commonly supposed. If, for example, General Patton's Third Army troops did indeed find and discover components and scientists from the SS project, then it would have been crucial to ascertain whether or not the "big fish" - to paraphrase Korsching's rather self-important view of the scientists at Farm Hall - had had any knowledge of these SS projects.

Then, in the transcripts of conversations from August 1-6, 1945, Dr. **Kurt Diebner** briefly mentions a fact that carries great significance in the light of what we have discovered of the German atom bomb project and the SS Sonderkommando underground factories in the Harz Mountains in Thuringia. Diebner mentions very briefly that his supply of radium was obtained "from the Harz."<sup>12</sup>

11 Bernstein, *op. cit.*, p. 100.

12 *Ibid.*, p. 111.

Bernstein's comment at this juncture is of a brevity huge with omissions: "A mountain range in central Germany." Bernstein does not have anything more to say about the subject. Is he ignorant of the claims being uncovered by contemporary German researchers? Or does the omission of mention stem from some other motivation?

In any case, the tenor and mood of the scientists quickly changes when they learn of the atom bomb dropped on Hiroshima. The first reactions, recorded by the British microphones, occurs between Hahn and Wirtz:

HAHN: They can only have done that if they have uranium isotope separation.

WIRTZ: They have it too.<sup>14</sup>

A discussion quickly ensues between all the German scientists, and again it is **Diebner** who makes a short statement pregnant with significance: "We always thought we would need two years for one bomb."<sup>15</sup> Moreover, Bernstein at this point betrays a hesitation and uncertainty unusual in his otherwise straightforward commentaries and annotations whose aim is clearly to maintain the Allied Legend:

"I am not sure whom Diebner includes in his 'we' here or on what his estimate is based. But his use of the word 'bomb' is unchallenged by the others."<sup>16</sup>

14 Bernstein, *op. cit.*, p. 115, **emphasis added**.

15 *Ibid.*, p. 117.

16 *Ibid.*, p. 118.

Who indeed were the people that Diebner referred to when he said "we"? Bernstein appears not to know, but given that Diebner has earlier referred to his supply of radium "in the Harz", we may rationally speculate that Diebner was referring obliquely, and no doubt intentionally so, to his colleagues in the SS run program.

Then follows a short, but astonishing, exchange between Hahn, Weizsacker, Harteck, Wirtz, and Diebner:

HAHN: I think it's absolutely impossible to produce one ton of uranium 235 by separating isotopes. <sup>17</sup>

WEIZSACKER: What do you do with these centrifuges?

HARTECK: You can never get pure "235" with the centrifuge. But I don't believe that it can be done with the centrifuge.

WIRTZ: No certainly not.

HAHN: Yes, but they could do it with mass spectrographs. Ewald has some patent.<sup>18</sup>

DIEBNER: There is also a photochemical process. <sup>19</sup>

17 This comment, in the light of what has already been learned about the size of the German enrichment program, can mean only one of two things: (1) Hahn is deliberately lying here, to deflect his on possible involvement in the program; or (2) he is telling the truth, and knows nothing about it. Of the two, the latter is the much more likely.

18 Again, Hahn has pointed the way clearly to Baron Manfred Von Ardenne's cyclotron modifications. Thus, the German scientists knew how to do it, and as is therefore extremely likely, the SS also knew which was the best method. Hence, the extraordinary power consumption at Auschwitz points, as does the most efficient method itself, to Von Ardenne's method as the method most likely used there and elsewhere to separate isotope.

19 Bernstein, *op. cit.*, p. 118.

Now let us put all this in context, for this little exchange is an indication that a possible "farce" is being played out at Farm Hall, not only by the interred German scientists, but also possibly by the declassification of the transcripts themselves.

What do I mean by this? Note that the transcripts are declassified by the British after the German reunification in 1989, an oblique admission, perhaps, that there was no more purpose in maintaining whatever secrets they still held, since there would now be other sources available to tell the story that had been long suppressed: that the Nazis had been either perilously close to, or had actually acquired the atom bomb before the Allies.

First, note in the above exchange that **Otto Hahn**, whose remarks began this chapter, has now changed his mind. His earlier remarks mention isotope separation as the means to a bomb. Now, he has reversed himself, and all on the same day. But then comes Weizsacker's remark: What else would one use centrifuges for?<sup>20</sup>

This is countered by remarks from the inventor himself, **Paul Harteck**, who maintained one cannot obtain "pure 235" via that process. Wirtz then chimes in with agreement, and then Hahn, ever the radio-chemist, reverses himself again, within a matter of minutes, by coming to the obvious conclusion from a scientific and engineering standpoint: the best way to obtain "pure" U<sup>235</sup> was via mass spectrography.

But then comes the bombshell. Diebner, who clearly has some connection to Kammler's SS "think tank" special projects empire in the Harz mountains, alludes to an unknown "photochemical" process for isotope separation and enrichment. Even Bernstein admits that whatever Diebner meant by this remark is "unclear"<sup>21</sup> In all likelihood, it is unclear, because it remains classified, somewhere, by someone. And that should give us pause, for it means that the Kammlerstab may have found a method of isotope separation and enrichment that remains otherwise unknown to this day!

Shortly after this revealing little exchange, Wirtz then offers another solution: "I would bet," he says, "that it is separation by diffusion with recycling."<sup>22</sup>

<sup>20</sup> As we shall discover, there may well have been another use to which this, or a modified, technology had been put by the SS.

<sup>21</sup> Bernstein, op. cit., p. 117, n. 24.

<sup>22</sup> Ibid., p. 118.

Wirtz is clearly proposing that separation was a multi-staged process, with the result of one pass through the separation process then being used as feedstock for another pass for enrichment to greater purity, and the process being repeated until the desired grade of purity - weapons grade - was obtained. The diffusion process mentioned in this context is vague, for there were at least two methods known to the Germans, the Allies, and the Japanese under the name of "diffusion".

One method, cited by Bernstein as the explanation of Wirtz's remarks, is the manufacture of uranium gas, and forcing it under pressure through sinterized metal. Sinterization simply means that a metal contains billions of micro-pores or holes of specific and tiny size, through which the atoms of different isotopes diffuse at slightly different rates of speed.

"The original estimate was that 5,000 of these barriers would be needed for nearly complete separation, as opposed to 22,000 centrifuges."<sup>23</sup>

The other process was thermal diffusion that was already examined more closely in [chapter 7](#).

The thermal diffusion method is mentioned briefly in the published Farm Hall transcripts during the conversations of the German scientists on the day of the Hiroshima bombing by Weizsacker.<sup>24</sup> Bernstein notes of this method that it was being tried by Korsching, and that it consisted of a "glass tube and heating coil to separate isotopes. It never worked well for uranium."<sup>25</sup> But what Bernstein has described is the original Clusius-Dickel tube for thermal diffusion, a process that was not efficient, as Bernstein correctly indicates. However, a different method of Clusius tubes was described by Wilcox in reference to the Japanese program:

What the Nishina group finally did settle on was a process called thermal diffusion. This had been one of the first isotope separation processes devised. But until it was perfected by two German scientists, Klaus Clusius and Gerhard Dickel, in 1938, it had not been practical. Stated simply, thermal diffusion relied on the fact that light gas moves toward heat. Clusius and Dickel constructed a simple device consisting chiefly of two metal tubes placed one inside the other. The inner tube was heated; the outer tube was cooled.

When the apparatus was turned on, the lighter U-235 moved to the heat wall; the U-238, to the cold wall. Convex currents created by this movement sent the U-235 upward; the U-238 downward. The result was something like a heated house in winter; hot air rising, cold air staying at the bottom. At a certain point the U-235 at the top could be collected, and new gas pumped in. It was a simple and rapid way to get relatively large concentrations of U-235.<sup>26</sup>

<sup>23</sup> Bernstein, op. cit., p. 119, n. 28.

<sup>24</sup> Ibid., p. 199.

25 Ibid., p. 83, n. 27.

26 Robert K. Wilcox, *Japan's Secret War*, p. 95, emphasis added.

And with repeated passes through a series of such vessels, purity would be increased. In any case, there is some discrepancy in the method as described by **Bernstein**, and that by **Wilcox**. Perhaps the latter described a modification made to the original method, with extremes of heat and cold being applied.

Harteck, Wirtz, and Heisenberg then continue the subject to isotope separation and enrichment a little further on:

HARTECK: They have managed it with mass spectrographs on a large scale or else they have been successful with a photochemical process.

WIRTZ: Well I would say photochemistry or diffusion, ordinary diffusion. They irradiate it with a particular wavelength (all talking together).

At this juncture, Bernstein again observes that "it is not clear" what this photochemical process is.<sup>27</sup> In any case, whatever the process was, Wirtz's mention of it and of irradiation with a particular "wavelength" appears to have provoked a burst of conversation from the other scientists. Were they intentionally trying to drown him out and mask his statements so as not to be recorded? We will never know. But in any case, the conversation continues:

HARTECK: Or using mass spectrographs in enormous quantities. It is perhaps possible for a mass spectrograph to make 1 milligram in one day - say of "235." They could make quite a cheap mass spectrograph, which, in very large quantities, might cost a hundred dollars. You could do it with 100,000 mass spectrographs.

Again, Bernstein's comment is suggestive: "This is essentially what the Allies did."<sup>28</sup>

27 Bernstein, *op. cit.*, p. 120, n. 37.

28 Ibid., p. 120, n. 38.

But it is also, as we have seen, very probably what the Germans did at the "Buna plant" at Auschwitz and later, in the large underground factories run by Kammler's SS Sonderkommando. The Farm Hall scientists, as to be expected, seemed totally oblivious to this program, but have worked out the basic facts for themselves.

HEISENBERG: Yes, of course, if you do it like that, and they seem to have worked on that scale, 180,000 people were working on it.

HARTECK: Which is 100 times more than we had.<sup>29</sup>

It may have been 100 times more than **Harteck** or any of the high profile scientists interred at Farm Hall had at their disposal, but it was certainly not a number beyond the SS, with its hundreds of thousands of concentration camp slave laborers. Hahn later reinforces the pathetic plight of the "Heisenberg group" by adding "Of course, we were unable to work on that scale."<sup>30</sup> Such facts and methods would doubtless have been known to the Kammlerstab, and doubtless he would have pursued them with his customary "focus."

Harteck then corroborated this view in a statement regarding the Clusius process, and his numbers reveal the dangerous potential for isotope separation and enrichment that lay within Nazi Germany's capabilities if worked on a similarly large scale as the Manhattan Project:

If it is a fact that an explosive can be produced either by means of the mass spectrograph - we would never have done it as we could never have employed 56,000 workmen. For instance, when we considered the Clusius-Linde business combined with our exchange cycle we would have needed to employ 50 workmen continuously in order to produce two tons a year. If we wanted to make ten tons we would have had to employ 250 men. We couldn't do that.<sup>31</sup>

29 Ibid., p. 120

30 Ibid., p. 121.

31 Ibid.

For Harteck and the other Farm Hall scientists, the problem was not means or methods, it was simply a labor shortage, a shortage the SS was not experiencing. Later, Harteck is even more specific:

Considering the figures involved I think it must have been mass spectrographs. If they had had some other good method they wouldn't have needed to spend so much. One wouldn't have needed so many men.

**Korsching** responds, and a small debate ensues, in which a sensitive topic is barely touched upon by **Harteck**, and Bernstein's editorial comment becomes either an exercise in ignorance, or deliberate omission:

KORSCHING: It was never done with spectrographs.

HEISENBERG: I must say I think your theory is right and that is spectrographs.

WIRTZ: I am prepared to bet that it isn't.

HEISENBERG: What would one want 60,000 men for?

KORSCHING: You try and vaporize one ton of uranium.

HARTECK: You only need ten men for that. I was amazed at what saw at I.G. <sup>32</sup>

<sup>32</sup> Bernstein, *op. cit.*, p. 122, *emphasis added*.

Bernstein's only comment here is to note the obvious, that "I.G." means "**I.G. Farben**," nothing else is said. Either Bernstein is unaware of the Farben "Buna plant" and its mysterious properties of consuming more electricity than Berlin and producing no Buna, or he has intentionally omitted any further clarification of Harteck's remark. The Allied Legend, in so far as Bernstein is concerned, is intact.

For his part however, Harteck is either clearly implying that he saw some large scale effort underway by I.G. Farben, employed tens of thousands of workers, or his remarks might also be construed to indicate that the Germans had discovered a method to make the process less labor intensive. In any case, I know of no other Farben facility in Germany at the time that was known to be working on enrichment.

The only facility with the requisite "enrichment facility" signature is the one at Auschwitz, and this means that Harteck may have seen not only a project as large as that at Oak Ridge, Tennessee, but one that was either more efficient - as we know Von Ardenne's mass spectrographs to be - than its American counterpart, as well as one less reliant on skilled labor, for the labor at Auschwitz, was "inexhaustible", and unfortunately, suspendable.

In any case, if all this is so, then it is a strong indicator that Harteck's and possibly some or all of the other interred scientists' remarks in the Farm Hall transcripts are careful stage-acting, a script that reveals just enough engineering savvy to indicate that the scientists knew at least the broad outlines of how an atom bomb could be achieved without a nuclear reactor (or "uranium engine" as they called it), and yet interlarded with just enough ignorance on specifics to indicate either that they were not involved at the highest levels, or that they were deliberately dissembling.

In Harteck's case, at least, we must opt for deliberate dissembling to a certain degree, for what he saw - if he was not completely involved with it - was a vast enrichment program proceeding on the emaciated backs of concentration camp laborers.

As if this were not enough, **Weizsacker** later corroborates the broad outlines of the top secret SS program we have outlined previously:

WEIZSACKER: If you had wanted to make a bomb we would probably have concentrated more of the separation of isotopes and less on heavy water.... If we had started this business soon enough we could have got somewhere. If they were able to complete it in the summer of 1945, we might have had the luck to complete it in the winter 1944-45. <sup>33</sup>

<sup>33</sup> Bernstein, *op. cit.*, p. 123.

Note that he not only corroborates the broad time frame we have already found for the alleged German atom bomb test at Rugen, but more importantly, his statement comes after Harteck's clear allusion to the existence of just such a program in Nazi Germany.

A little later, the British military intelligence summary of the conversation that ensues interjects the following cryptic summary of comments made by **Walter Gerlach**, without any further commentary:

"Gerlach goes on to explain that the Nazi party seemed to think that they were working on a bomb and relates how the Party people in Munich were going round from house to house on the 27th or 28th of April last telling everyone that the atomic bomb would be used the following day."<sup>34</sup>

Bernstein's editorial note reflects his confusion, and confirms that he is in all likelihood not familiar with the allegations of the tests at Rugen and Ohrdruf: "It is not clear who has supposed to be using this weapon and against whom."<sup>35</sup>

In any case, so far from contradicting the possibility of a secret enrichment and bomb program, however, in the main the Farm Hall scientists seem to corroborate it.

Finally, Harteck again must have stunned his British captors with a remark made near the end of the transcript for August 6, 1945:

HARTECK: The multiplication factor with "235" is 2.8, and when one collides with the other how long is the path until it happens? 4 centimeters, Rx is the radius. Then you have to multiply that by the mean free path and divide it by the square root of the multiplication factor. That should be 3.2. Rx is about 14 centimeters, the weight is 200 kilograms; then it explodes.<sup>36</sup>

Even Bernstein cannot ignore this, and his comment indicates there is a "possible something" lurking behind Harteck's figures:

This apparently off-hand calculation of the critical mass by Harteck which does lead to a sensible answer, unlike Heisenberg's shows some evidence that he had done this problem before. It is difficult to believe that he would have known, for example, that the critical radius involved the inverse square root of the multiplication factor if he had not thought about it. How Harteck got the number 2.8 for the multiplication factor is unclear.

During the war the Los Alamos people, who certainly knew a lot more than he did, used 2.2. Only after the war was the number increased to 2.52 as the measurements became better. Perhaps it was Harteck who supplied the German Army Ordnance report of January 1942 with its numbers in the scientists' attempts to interest the Army in continuing support of bomb research.<sup>37</sup>

<sup>34</sup> Ibid., p. 126.

<sup>35</sup> Ibid., n. 85.

<sup>36</sup> Ibid., p. 133.

<sup>37</sup> Ibid., n. 121.

Perhaps Harteck had "run the numbers" before. But there is another possibility.

Perhaps, on his visit to "I.G." that he alluded to earlier, someone had shown Harteck the numbers. In this regard it is perhaps significant that of all the Farm Hall scientists, his comments most consistently point to the acknowledgment of a feasible method that, with large enough scale, could lead to sufficient quantities of fissile weapons grade uranium. And it is significant too that the transcripts reveal a variety of methods known and available to the Germans that, used in sufficient numbers and with a sufficient labor pool, could have done exactly that.

Harteck's comments point in the consistent and general direction of **Manfred Von Ardenne**, **Fritz Houtermans**, and the rubberless "Buna facility" of I.G. Farben at Auschwitz. Like the Farben directors themselves in the dock at Nuremberg, Harteck is perhaps, in his own subtle way, trying to set the record straight. These facts and associated speculations also perhaps explain why, after so many years, the Farm Hall transcripts were finally declassified, for they do not, in the final analysis, serve the Allied Legend well.

[Back to Contents](#)

## Chapter 10: GATEWAY TO THE BLACK SUN: CONCLUSIONS TO PART ONE

"So it is that proof of an arrangement between Martin Bormann and the United States, if there was one, does not appear to exist. What is apparent, however, is that the United States went to some trouble to ensure that such evident of a relationship does not exist!"

**Carter Hydrick**  
Critical Mass<sup>1</sup>

<sup>1</sup> Carter Hydrick, Critical Mass, internet publisher manuscript ([www.3dshort.com/nazibomb2/CRITICALMASS.txt](http://www.3dshort.com/nazibomb2/CRITICALMASS.txt)), p. 133.

I believe a strong prima facie case has been outlined that Nazi Germany developed and successfully tested, and perhaps used, an uranium atom bomb before the end of World War Two, and possibly that it had made significant strides toward the acquisition if not outright testing, of a boosted fission plutonium bomb of small critical mass and high yield.

This thesis, radical as it is, does seem to resolve at a stroke discrepancies and anomalies - some seemingly trifling and others much more blatant - about the political and operational history of the war. The idea of an actual German atom bomb and project, and not the small, miserably failed, laboratory effort proffered by the Allied Legend, seems to provide suitable explanations for a host of things that have long puzzled analysts and commentators.

For example, what of Hitler's declaration of war against the United States in December of 1941, after the Japanese attack on Pearl Harbor? Analysts have puzzled over this decision and his possible motivations in doing so for decades, and a variety of unsatisfactory explanations have been advanced, from his bourgeois sense of "duty" to his Japanese ally, to the secret naval war fought "off the books" for months between the Third Reich and the United States and the need to make it "official", to Hitler's impatience, delusions, and/or insanity, to the realization by the Nazi leadership that Roosevelt meant to enter the European war one way or another no later than 1943.

But regardless of what Hitler's motivations or thought processes may have been, from the standpoint of conventional military analysis, the German declaration of war on America was sheer suicide, as her overwhelming production capacity and oceanic insulation virtually assured her of initial supremacy over the Nazi war-making juggernaut. Hitler's decision, as German armies were stalled and freezing to death at the gates of Moscow in 1941, seems more than suicidal. Hitler was shown for what he was: a madman. But from the perspective of the evidence presented here, that was not the real military picture in December 1941 at all, not was it in the secret counsels that the German dictator kept in his mind.

His scientists, after all, had discovered nuclear fission, and his scientists had proposed a method of obtaining an atom bomb via large quantities of isotope separation and enrichment machines and huge concentrations of labor. His scientists would, in a month or so, assure him, via the *Heereswaffenamt memorandum*, that the amount of material needed for a bomb was not tons, but kilograms. And his favorite atomic scientist, **Manfred Von Ardenne**, and his associate Dr. **Fritz Houtermans**, had already published a manuscript on how it could all be done. And he knew, too, that Germany had the needed material - uranium - in an abundance that the United States could only scarcely imagine.

In retrospect, then, the secrecy surrounding the German project seems all too clear, for the best source of cheap labor lay in the death camps, camps that Hitler desired to keep secret from the German people, for obvious reasons. By early 1941 [Farben](#) had already begun construction of its "Buna plant" at Auschwitz. And there was more probably lurking in Hitler's twisted mind: before the war, some scientists in the Reich had spelled out the basic idea behind a weapon even more powerful than the atom bomb, for which the latter was but a fuse. Hitler, on this view, ever the gambler, too the risk, confident of being in the possession of a fearful arsenal within a short span of two to three years, and declared war on the United States.

So too the military deployments and operations of the European war's end that made little sense before now begin to take on an operational logic that is almost irresistible. The madcap, and some would say, militarily and politically indefensible, Allied dash away from Berlin and to south central Germany and Prague are consistent with American knowledge, at some very high level, of Kammler's SS Sonderkommando black projects and secret weapons empire. Hitler's own obsession with the defense of Breslau in lower Silesia and of Prague itself, an obsession that made no sense to his generals, make military sense only in the context of an atom bomb and intercontinental rocket project that was successful in the attainment of the first and perilously close to the attainment of the second.

Similarly, Reichsfuhrer SS Heinrich Himmler's offer of a surrender to the Western Allies has usually been dismissed as the frantic attempts of a desperate mass murderer to avoid his inevitable fate, and nothing more. But [Himmler](#), like [Hitler](#), and possibly only [Martin Bormann](#), was one of the "inmost circle" who knew the full extent of Kammler's empire and its actual activities Himmler may have therefore used this knowledge as a possible bargaining chip. His offer was rejected, not so much because it was not genuine (from Himmler's point of view), but because he had long lost genuine control of it. The

deal had already probably been cut between **Kammler's** representatives and OSS station chief in Zurich, **Allen Dulles**, or via General Patton himself. Bormann, too as we have seen, was implicated in this plot, and, as we shall see in subsequent chapters, is directly linked to Kammler.

The thesis of an actual German atom bomb also explains the odd little events that began to surface in scattered Allied press reports toward and immediately after the end of the European War long-range heavy lift round trip "proof of concept" flights from Europe to within sight of New York City, Luftwaffe maps of Manhattan with blast damage estimates for an atom bomb of the same approximate yield as Hiroshima, a Norwegian airfield filled with over forty long range bombers capable of making the flight, "Buna plants" that incomprehensibly use more electricity than Berlin and paradoxically produce no rubber during the entire course of the war, U-boats loaded with infrared fuses - a device whose technical complexity betokens an immediate nuclear application -and enriched uranium powder ready for metallization.

Likewise, this thesis provides a more plausible explanation, for those inclined to think it suspicious, for the mysterious death of America's most celebrated and famous, and for the equally impossible "triple death" of Germany's most sinister, generals. Patton, as was seen, was the commander of the very America army entrusted with seizing the mother-load of secret weapons research treasures in Thuringia and at Pilsen in Czechoslovakia. He, at the top of the Third Army's command structure, would have been privy to all the first intelligence reports of his units entering those areas, and would easily have been the first man outside Kammler himself to see enough of the pieces to put together a reasonable picture of the whole. If indeed Patton was deliberately silenced, and I am by no means convinced that he was, then surely this is the most plausible motivation for the deed.

And finally, as was seen, a successful German atom bomb project might very well me the inner moral logic at work in the German Resistance's bomb plot against Adolf Hitler in July of 1944. Similarly, the thesis puts on a firmer foundation another set of "oddities," such as the ludicrous notion that the Allied engineers were so confident that their design for the Little Boy uranium bomb dropped on Hiroshima was so good it did not need to be tested, or (in another explanation), that there was not enough weapons grade uranium to build two such bombs to test one before dropping the other.

That the US military would have dropped an untested super-weapon on an enemy city, an enemy known to be working on acquiring the very same weapon, is simply ridiculous in the extreme. The Allied Legend is made even more ridiculous when one considers the fact that the plutonium bomb had been successfully tested, and that a plutonium bomb was already ready for deployment against the Japanese. Why then was the "untested" Little Boy dropped first, instead of the plutonium "Fat Man"? A rational explanation is afforded by the thesis of this part of the book: Little Boy was not tested by the Americans because, as Oppenheimer hinted, the bomb was "of German provenance." The Americans did not need to test it, because its German designers already had.

Moreover the infusion of German bomb technology into not only the American, but the Japanese effort, explains Japan's rather slow response to Allied demands for unconditional surrender after Hiroshima and Nagasaki, for only a day after Nagasaki, the Japanese too, for a brief moment, joined the nuclear club. And five years later, **MacArthur** presided over one of America's worst military debacles at the Chosin reservoir in the midst of the largest industrial complex in Asia, built by Japanese industrialist **Jui Noguchi**, and nerve center of the Japanese atom bomb program Were the operational risks MacArthur took to secure and hold Chosin due in part to a hidden intelligence agenda, to secure more information about an enemy only recently defeated, and to deny the technology to potential enemies such as Red China?

And last, but surely not least, there is simply too much enriched uranium, and too many bombs, around by the end of World War Two, to have come entirely from the Manhattan Project. Marshal **Rodion Malinovsky's** translator told of a "dud" dropped on August 8 on Nagasaki and surrendered by the Japanese to the Russians - a Japanese bomb, two separate German tests, a bomb sunk on board the USS Indianapolis en route to Japan - and all these bombs from a Manhattan Project critically short of weapons grade uranium as late as December 1944, and only projected to achieve half the necessary critical mass by May of 1945? Where did all this extra uranium come from, not to mention the "extra bombs"? I have argued that most likely all of it came from Nazi Germany, courtesy of Nazi Party Reichsleiter Martin Bormann, and SS Obergruppenfuhrer Hans Kammler.

But these conclusions leave several problems to be resolved, and in their resolution, a further glimpse into Kammler's dark empire of secret weapons, think tanks, underground factories and slave labor is afforded.

How did the Russians know to request this bomb? Surely the United States would not have told them. The only other plausible explanation is that the Russians knew where the bomb was ultimately from, and had done the mathematics.

[Back to Contents](#)



## Chapter 11

### THE BLACK ORDER: THE OCCULT INFLUENCE ON NAZI SECRET WEAPONS

"There was, via the Kammler trail, a mounting body of evidence that the Nazis, in their desperation to win the war, had been experimenting with a form of science the rest of the world had never remotely considered.

And that somewhere in this cauldron of ideas, a new technology had been born; one that was so far ahead of its time it had been suppressed for more than half a century."

Nick Cook

[The Hunt for Zero Point](#)

As was seen, the Nazis very possibly may well have succeeded in developing and testing atom bombs prior to the end of World War Two, and may even have used them or some other weapon of mass destruction on the Eastern Front.

But in the argument of the previous chapters, indications of something even more sinister cast a pall over the developing argument. For example, in Professor **Lahner's** allegation, the Nazis were interested in the atom bomb as mere fuses for the far more destructive hydrogen bomb.

Beyond even the hydrogen bomb, there were hints and outlines of something shadowy, vague, and of monstrous destructive power.

British agents surface to tell of a "fourth" team developing and working in an area of physics that seemed almost magical; a scientist at Farm Hall mentions in passing the construction of artificial rubies; newspaper clippings report Allied officers coming forward in the immediate aftermath of the war to make it clear that it was won - not as an inevitability against a collapsing Reich - but just in the nick of time, a viewpoint quickly swept away in the triumphalism of the emerging Allied Legend and standard histories of the war.

A vast isotope enrichment program conducted by the SS in conjunction with the death camps casts a shadow on the ground, in spite of the best efforts of the postwar Allied Legend to touch up the photograph and render the object casting the shadow invisible, the ultimate in stealth technology.

The question is, why?

- Why cover up a successful German atom bomb well into the late twentieth and early twenty-first centuries?
- Why indeed, unless that program leads to something else something whose possession would give extraordinary technology and military power to the nation that successfully continued its development?
- Why indeed, unless that program leads to a wholly different scientific paradigm, developed in secret and off the pages of the textbooks of mainstream "science" proffered for public consumption?

Much of the answer to these questions lies in occulted aspects of the Nazi Reich's ideology, and in the structures of power and bureaucracy it put into place to pursue that ideology.

Much of the answer to these questions lies in the connection of Kammler's Sonderkommando to its parent organization, the SS itself. The nature of that organization, at its very heart, at the uppermost pinnacle of its power structure, was in every sense of the word occult.

There are two facts that directly connect Kammler's black, underground, and very secret weapons and death camps empire, to this *occult aspect* of the Third Reich and its SS "**Black Order**." These two odd connections require in turn an investigation - cursory though it will have to be - of the occult doctrines themselves in order that we may clearly discern the outlines of their influence on the more sensational German weapons research of the war. In connection with Kammler's empire and its postwar continuation, it is best to understand that this science is an "occulted science."

#### A. Some Necessary Definitions

For our purposes, this "occulted science" is to be understood as contained in various artifacts: ancient mysteries, various esoteric or other "occult traditions" per se, and actual physical structures or other types of physical artifacts. This broad definition requires farther "unpacking" in order for its full-scope to be adequately comprehended:

Occulted Science: The "science" component of this term focuses specifically on three general areas: physics, chemistry, and biology.

Our primary focus in the subsequent parts of this work will be on physics, with forays into the other two areas as needed. Thus, our thesis and method is that there is an "occulted physics" hidden - sometimes deliberately - within various mythological and ancient texts, including texts of the esoteric or occult traditions both of the Orient and of the Occident.

This belief was one of the cornerstones of the Nazi secret weapons research, and it produced some astounding failures, as well as grist for the mill of its less well known, but equally astounding successes. This thesis has formed a major component in my two previous works,<sup>2</sup> and was a major component in the ideological belief structure of the upper echelons of the SS and its more important and secretive departments, including the Ahnenerbe. There is every indication that it also formed a major paradigm for the upper echelons of Kammler's secret weapons "think tank" and was possibly even its very *raison d'etre*.

The occulted aspect of the term "occulted science" therefore takes on an extension of meaning beyond what one normally comes to associate with the term "occult". For our purposes, this "occulted science" is occulted in the sense of:

- (1) "hidden" or "dark" and therefore hidden in the sense of black and covert secret classified projects;
- (2) "deliberately encoded science" found in texts or artifacts that are, as the deliberate products of such encoding, subject to the full range of standard typological and analogical interpretive methods conventionally employed to understand such texts, but in this case, they are not understood on a metaphysical basis but rather in a "proto-scientific" sense, a "proto-physics" sense;
- (3) "non-deliberate corrupt transmission" of that science and its textual and/or physical artifacts by groups or communities not fully cognizant of the extent of the science actually encoded in them;
- (4) "esoteric or occult traditions and secret societies" in the conventional sense;
  - (a) By "esoteric or occult traditions" is meant not only standard occult texts and traditions and the various secret societies associated with them, but also traditions or legends that are not generally considered to be esoteric or occult in the stand sense; they remain esoteric or occult only because they are not well-known by the general public;
- (5) "buried or partially buried" in the mists of pre-history and the mythologies, legends, talismans and physical monuments typically associated with them.
  - (a) By "ancient mythologies or legends" is meant as legends, texts, scriptures (whether considered to be canonical or apocryphal by any given community), of various cultures. The cultures chiefly in view are the classical Sumerian, Egyptian, Hindu, Maya, Olmec, Scandinavian-Teutonic, Chinese, and of course the later standard Graeco-Roman European culture.

<sup>2</sup> Q.v. The Giza Death Star and The Giza Death Star Deployed, both published by Adventures Unlimited Press.

It will be evident from careful consideration of this outline, that the peculiar blend of logic, reason, and science with the metaphysical and speculative component is a paradigm that is readily adaptable to the peculiarly German turn of mind as it developed from the opening of the nineteenth century to the fall of the final bomb before the capitulation in 1945.

In my opinion, it is this type of thought that is the Allied Legend's real goal to conceal, for more than anything else Kammler's black SS Sonderkommando secret weapons, death camps, "think tank" empire was the first deliberately and consciously organized and orchestrated attempt by a modern nation state to commit massive financial, labor, technological, and most importantly, intellectual capital to an off-the-books black projects recovery and development of lost and exotic technology, by the application of the most *avante garde* conceptions of the then contemporary science.

Against this broad conceptual framework, we may now view two significant facts that place his think tank very clearly within the orbit of "occulted science" in many of the above senses.

## B. Into the Labyrinth of the Beast

In part one, evidence of a possible German atom bomb test at or the island of Rugen in the Baltic Sea was presented.

This evidence stemmed primarily from the recently declassified affidavit of **Hans Zinsser** who saw and described the explosion and resulting mushroom cloud, and the testimony of Italian officer **Luigi Romersa**, who was there apparently as an observer for Mussolini's Italian Fascist government.

Corroborating evidence of secret wartime British atom bomb alerts and German telephone outages in Berlin - events concurrent with the time frame of the test - were presented.

- But what of Rugen itself?
- Why test a weapon on a sparsely populated island that is so close to the population center of Kiel and its heavily trafficked sea lanes and canal?
- What is it about Riigen that is so significant that the SS would test an atom bomb there?

The answer may come from its possible connection to the SS's special "occult research" department, the Ahnenerbedienst, the society personally established by Reichsfuhrer SS **Heinrich Himmler** to investigate all manner of occult and esoteric doctrines for its possible scientific value and weaponization. Among the strange and irrational doctrines entertained by Himmler and others at the pinnacle of the SS was a peculiar twist to the "Hollow Earth" theory.

In its even more irrational Himmler variation, this theory held that the earth was hollow, and that its surface - the surface that the fanatical SS leadership actually lived on - was the inside of that "hollow earth".

And thus According to an article in *Popular Astronomy* in June 1946, entitled "German Astronomy During the War":

"They considered it helpful to locate the British fleet, because the curvature of the earth would not obstruct observation. Visual rays were not suitable because of refraction; but infrared rays had less refraction.

Accordingly a party of about ten men under the scientific leadership of Dr. Heinz Fischer, an infrared expert, was sent out from Berlin to the isle of Rugen to photograph the British fleet with infrared equipment at an upward angle of some forty-five degrees."

The experiment did not work.<sup>3</sup>

<sup>3</sup> Dusty Sklar, *The Nazis and the Occult*, p. 79.

One is left with the impression that this "experiment" with irrationality was but another manifestation of the scientific quackery that was the Third Reich, and rightly so. But significantly, once again, this rather *avante garde* experiment, no matter how irrational, took place on Riigen. Apparently, the island was home to a number of advanced projects.

One should also note carefully the hidden technological implication of the experiment, notwithstanding the insane use to which it was put: the Nazis possessed the means of detection of infrared reflections from great distances though atmospheric refraction, the same technology as was developed for use in heat-seeking anti-aircraft missiles and subsequently used with dramatic destructive effectiveness in America's plutonium bomb.

And this afford a clue into the real nature of Kammler's "think tank": technology appears to have been developed that could be adapted to a variety of uses in the various highly classified weapons developments black projects, as well as used in experimentation and testing of the more bizarre aspects of Nazi and occult beliefs.

But again, why Rugen?

The answer lies in the "esoteric history" of the island prior to the war, and indeed, prior to World War One! When the Second World War ended, Hitler's private library was discovered in a mine near his idyllic mountain aerie of

Berchtesgaden. Several tomes and volumes of occult literature were contained in it, including a "collection of (Lanz) Von Liebenfels' racist-occult magazine *Ostara*," published in Vienna before the First World War.<sup>4</sup>

While Hitler's own membership in any occult lodge has not been conclusively demonstrated, it is very probable that the young dictator-to-be actually visited Von Liebenfels while both were in Vienna before World War One.<sup>5</sup>

It is **Von Liebenfels** and his *Order of the New Templars* that forms the connection between the SS, irrational "Hollow Earth" experiments, and the far more successful atom bomb test at Rügen, with the assistance of wealthy patrons who soon flocked to his secret society - a society dedicated to the "purification" of the German race from its corrupting influences (Jews, Slavs, "Mongoloids" and basically anyone not "Germanic" or "Aryan") - Von Liebenfels was able to purchase and renovate several old castles throughout Austria and Germany and to transform them into centers for his Order. The Order, in addition to its racist ideology, also dabbled in "astrology, the Cabala, phrenology, homeopathy, and nutrition."<sup>6</sup>

In any case, Von Liebenfels, in the best traditions and tactics of classical "Christian Gnosticism," and with the aid of his monastic training as a Cistercian monk,

"composed his own voluminous variations of liturgical texts: a two volume New Templars' Breviary, The Psalms in German, and a 'secret Bible for the initiated' which ran to ten volumes, as well as prayer books and the like."<sup>7</sup>

With money pouring into his order from its wealthy "initiates", one of the castles he bought and restored as a center for esoteric research and "New Templar" activism was on the island of Rügen.<sup>8</sup>

4. Peter Levenda, *Unholy Alliance: A History of Nazi Involvement with the Occult*, p. 56.

5. Levenda, *op. cit.*, p. 56.

6. Sklar, *op. cit.*, p. 20.

7. *Ibid.*

8. *Ibid.*

Hitler was, according to Von Liebenfels in a letter to one of his *New Templars*,

"one of our pupils. You will one day experience that he, and through him we, will one day be victorious and develop a movement that makes the world tremble."<sup>9</sup>

When Hitler annexed Austria, Von Liebenfels was forbidden to publish. Indeed, the Nazis severely regulated - almost to the point of squeezing it into complete non-existence - any public display of "occultism" or "secret society" activity.

Hence, Himmler's motivations for creating the SS Ahnenerbe within the bureaucracy of the SS becomes clearer, for the regime was in part fearful of its own connection to the highest level to such societies and activities.

By placing such activities under SS jurisdiction, they could be monitored, studied, funded, organized, and exploited in complete secrecy.

What was the **Ahnenerbe**?

In many respects it was the most secret of all the SS' myriad secret departments.

Imagine that the evening adult education program of the *New School of Social Research* had suddenly become an independent government agency with a budget as big as the Defense Department, with Lyndon Larouche as president and, perhaps, Elizabeth Clark Prophet as the physics chairperson.

Or maybe the summer session at the University of California Berkeley, had become militarized and all the students had immunity from prosecution for any crime they had committed, or would ever commit, and could conduct any form of independent study they liked as long as they wore their black uniforms with the silver death's head insignia at all times and swore an oath of personal loyalty to the dean.

The one might have some idea of what the Ahnenerbe was, and of the type of people it first attracted to its ranks. It was a humanities program. With guns.<sup>10</sup>

<sup>9</sup> *Ibid.*, p. 21.

<sup>10</sup> Levenda, *op. cit.*, pp. 151-152.

This bizarre and irrational element of the occult at the very heart of *Himmler's Black Order of the SS* is one of the hidden entities, for example, coordinating and conducting the gruesome "medical experiments" on concentration camp victims, and even on ordinary Germans, during the war.

During the height of the war, the insanity gripping the Ahnenerbe and its macabre and bizarre experiments became almost surreal.

The bureau devoted so much manpower and money to,

"esoteric research projects that it began to seem as if (Himmler) hoped to turn the tide in Germany's favor by fathoming the secrets of Rosicrucianism and Freemasonry, the occult meaning of Gothic spheres the top hats worn by the boys at Eton, and the symbolism involved in the suppression of the Ulster harp."<sup>11</sup>

Among its most ambitious projects, enormous amounts of money were spent

For a flight to Tibet to look for traces of a pure Germanic race which might have been able to keep intact the ancient Nordic mysteries. The Ahnenerbe also had archeologists digging up all of Europe for remains of Germanic culture. More than fifty departments in this branch succeeded in spending over a million marks (\$400,000) on such "vital" matters.

But the most incredible research of all was set up in 1939 in Merlin.

An astrologer, Wilhelm Wulff, who was made prisoner of the SS and coerced into working for it, described the Berlin Institute's scientific research center as being used,

"to harness, not only natural, but also supernatural, forces. All intellectual, natural, and supernatural sources of power - from modern technology to mediaeval black magic, and from the teachings of Pythagoras to the Faustian pentagram incantation - were to be exploited in the interests of final victory."<sup>12</sup>

<sup>11</sup> Sklar, *op. cit.*, p. 101

<sup>12</sup> Sklar, *op. cit.*, p. 102

One such experiment resembles nothing else so much as an early experiment in "remote viewing", and included a man who was an alleged "adept," who held out pendulums over pictures of U-boats, and then held it over maps of the ocean in attempts to detect it.

If all this seems insane and fruitless dabbling, consider that the modern phenomenon of "remote viewing" is a highly developed enterprise - undertaken initially in secret by the CIA<sup>13</sup> - and employed at one time none other than renowned theoretical physicist Dr. Hal Puthoff in the elaboration of strictly controlled scientific protocols for its testing.<sup>14</sup>

<sup>13</sup> A fact that in itself should give one pause, especially in view of the subsequent importation of many of these Nazi "esoteric scientists" into the USA under the aegis of Operation Paperclip.

<sup>14</sup> Q.v. Joseph McMoneagle, *Remote Viewing Secrets*, pp. xv, 46-47. The research was conducted by SRI International, an organization that I have

Moreover, note what is actually being asserted: the Ahnenerbe's portfolio was to investigate any potential source of power for weaponization. And notably, all normal constraints or orthodox conceptual or moral paradigm were laid aside. In that context, there were bound to be more failures than successes. But equally, in that context, in that bureaucratic culture, the

freedom to "brainstorm", to generate and then to pursue the unorthodox novel idea, would have been given more or less free rein. Indeed, it would have been expected.

Consequently, the Ahnenerbe's failures, or its barbarous cruelty, are often paraded as evidence of a pervasive breakdown not only of traditional morality, but of the scientific establishment and method in Nazi Germany. But what are overlooked are the indications of its possible - and groundbreaking - successes, for in the milieu of free experimentation without constraints (moral or otherwise), dramatic failure was to be expected.

But the potential for dramatic success was equally as great.

"There was, via the Kammler trail," notes *Jane's Defence Weekly* reporter and researcher **Nick Cook**, not without a tinge of anxiety, "a mounting body of evidence that the Nazis, in their desperation to win the war, had been experimenting with a form of science the rest of the world had never even remotely considered.

And that somewhere in this cauldron of ideas, a new technology had been born; one that was so far ahead of its time it had been suppressed for more than half a century."<sup>15</sup>

Was Kammler's secret weapons *Sonderhommendo* think tank connected to the *Ahnenerbe*?

<sup>15</sup> Nick Cook, [The Hunt for Zero Point](#), p. 209.

Covered in my previous book *The Giza Death Star Deployed* (pp. 73075, 92) in connection with its other "occulted science" research concerning the Great Pyramid and the Second Pyramid at Giza.

[McMoneagle](#) cites one of the original theoretical papers concerning remote viewing, co-authored by Dr. [Puthoff](#) and [Russell Targ](#), entitled *A Perceptual Channel for Information Transfer over Kilometer Distances: Historical perspectives and Recent Research*.

It is important to mention that most of Dr. Puthoff's theoretical physics research concerns quantum mechanics and the Zero Point Energy, or vacuum quantum flux potential.

Puthoff has noted the connection between quantum mechanics and the consciousness of intelligent observers. More recently the connection between intelligent life and physics at the topological level has been a major focus of papers by Ukrainian theoretical physicist Dr. **Volodymyr Krasnoholovets**, and French topologist **Michel Bounias**.

While no direct evidence has been forthcoming to date, there is a factor - beyond his involvement with the death camps - that does connect Kammler with the Ahnenerbe, and this brings us to that "second odd fact", a detail that seems to indicate that there was indeed a connection between the Ahnenerbe's occult interests and Kammler's black secret weapons projects "think tank."

This is the fact that at its very pinnacle, the SS was deliberately conceived and organized by [Heinrich Himmler](#) to be an occult "order," a black and twisted version of King Arthur's Knights of the Holy Grail and Round Table.

One observes here, once again, the connection to the ideal the Templars and Von Liebenfels' "New Templars," for whom the "holy Grail", or sang real, was the "royal bloodline" itself and its "container" or "chalice", the Germanic Aryan race.

As a result of this view, the Ahnenerbe's "medical experiments" were done not only to advance German medicine in areas of treatment of extreme conditions - high pressure, low pressure, and so on - that were encountered in extreme climates or, eventually, outer space, but a considerable portion was devoted to finding the basis of genetic and ethnic "purity" of the Germanic race itself.

The SS was therefore the vanguard, the prophetic forebear, of the new religion and new age and new man it hoped to usher in:

The headquarters for this cult was situated at the medieval castle of Wewelsburg, near the towns of Paderborn and Detmold in the German province of Westphalia, close by the site in the Teutoburg Forest where Arminius made his stand with its famous, Stonehenge-like monument known as Externsteine....

Secrecy was the key element in the SS and most especially at Wewelsburg.<sup>16</sup>

There Himmler had constructed a central chamber with a large table designed to seat twelve men specially selected from the senior *Gruppenfuhrers* (generals) of the SS.<sup>17</sup> A 12,000 volume library of the occult was available in the castle.

<sup>16</sup> Levenda, op. cit, pp. 155-156.

<sup>17</sup> Ibid., citing Padfield, *Himmler: Reichsfuhrer-SS* (New York: Henry Holt & Co., 1990), p. 248.

### C. The Black Sun, the Celestial Swastika, and Other SS Connections

Central to the secret initiation that these senior SS generals received was the real significance of the anagram "SS" itself.

For the "rank and file elite" of the SS, the initials stood for the German word *Schutzstaffel*, a term meaning loosely a *special staff* or *military unit*. But to the initiates, there was another meaning of "SS" altogether, a meaning with roots deep in the occult and in ancient Sumerian, Babylonian, and to a certain extent, Egyptian belief. For these initiates, the letters "SS" referred to *die Schwatze Sonne*, the Black Sun.

The *doctrine of the Black Sun*, reaching back to ancient Sumer and Akkadia, is that there are two suns, the "white" sun, the sun that we see at the center of our physical solar system, and the "black" sun, a "hidden" sun of (spiritual) illumination. In some versions of the myth, it is thought to reside at the center of our galaxy.

Other embellishments place it as one of the causes of the immortality and reincarnation of the soul.

In Babylonian mythology it was also associated with the coming of the "King of kings" and the establishment of a New Babylon. And finally, in some variations, not only is it associated with the center of the galaxy, but also with the uttermost "Hyperborea" and "Thule", the legendary stellar home and celestial origin of the Aryan race. The doctrine received further modification in ancient Egypt.

The connection between the SS and Egypt is further evidenced by the case of one of the most famous esotericists of all: **R.A. Schwaller de Lubicz**. Well known to contemporary students of "alternative" or "revisionist" Egyptology, de Lubicz' claim to fame was his life-long undertaking to reinterpret the monuments, and more importantly, the writings of ancient Egypt, particularly its hieroglyphic system of writing.

While many contemporary researchers denigrate de Lubicz's work as being either faulty or slipshod, and while others denigrate his scholarship simply for his open support of the Nazi regime, it is not so easy to dismiss him as all that.

For one thing, it was de Lubicz who first noticed the weathering on the Sphinx was inconsistent with a Fourth Dynasty origin for the monument, and that it pointed to a much older and far more *ancient pedigree*.<sup>18</sup> It is *the Lubicz's method*, however, that would have been quite at home within the Ahnenerbe and more importantly, within Kammler's black projects think tank. Briefly put, de Lubicz viewed Egyptian hieroglyphics and culture as the visible signs of a highly developed culture of *analogical*, rather than *analytical*, thought, science, and practice.<sup>19</sup>

For him, analogical thought was synonymous with "action at a distance,"<sup>20</sup> and his thought here is quite in line with what was beginning to be bandied about in quantum mechanics, and has become a provable reality in our day, with the phenomenon of *photon entanglement*. This phenomenon, briefly put, is as follows. Imagine two photons have been simultaneously emitted from a particular atom, but traveling in different directions.

Thus, both photons carry the harmonic systems signature, the information, of the original atom and the circumstances of their emission.

Then, imagine changing the informational signature of one of the two photons. Because the other photon is an exact analog of the first photon, it will simultaneously introduce the change into the field of its own information, instantaneously, regardless of distance.<sup>21</sup>

But it is important to note that for de Lubicz, this *analogical action* at a distance or sympathetic magic was expressed within the context of a broadly dualistic world view in which there were two sciences, one of *genesis or creation*, and one of *destruction*.<sup>22</sup>

18 De Lubicz's observation, in fact, inspired John Anthony West and Robert Shock's investigations which have re-dated the Sphinx to approximately 8,000 B.C. based on geological evidence, a conclusion that sent shock waves -no pun intended - through the Egyptology community and continues to spark vigorous debate in academic circles.

19 Q.v. R.A. Schwaller de Lubicz, *Symbol and the Symbolic*, (New York: Inner Traditions International, 1978), pp. 7, 20.

20 Ibid., p. 46.

21 That this was a major blow to relativity goes without saying. Photon quantum entanglement, as the phenomenon is called, is one of the newest and most exciting areas of contemporary physics experimentation and research.

22 De Lubicz, op. cit, p. 25.

In this context, any given hieroglyphic symbol became a synthesis of polarities of particular oppositions of forces, held in balance by the glyph - the information - itself.

Without a doubt, this broadly Hegelian view brought de Lubicz to the attention of the Nazis, and vice versa. But more importantly, it was de Lubicz's knowledge of Egyptian "science-religion" that may lurk in the background of the statements of the Japanese attaché to Stockholm's curious statements about Sirius in his secret cable to Tokyo regarding the German atom bomb program that we examined in part one, for **de Lubicz** would have been in a position to point out *the significance of Sirius to the Egyptians*.

For then, it "played the role of a central sun to our entire solar system" and suggested to de Lubicz,

"the existence of a cosmic system of atomic structure whose nucleus is this 'Great Provider,' the Sothis... of the ancients."<sup>23</sup>

*De Lubicz* would have known as well the ancient symbolism and association with the three colors of the German national flag - black, red, and white - with [ancient Egypt](#) and [Atlantis](#),<sup>24</sup> a symbolism of which the Nazis themselves were likely aware.

Thus in its Egyptian variation, the "Black Sun" myth is bound up with the star system of [Sirius](#), and with all the associations with *death resurrection*, and the "life force" that this entailed within Pharaonic religion.

For the SS Ahnenerbe, all this was a potent mix when one recalls that Himmler's stated purpose for it, revealed in a letter he wrote to an Ahnenerbe scientist, was not only to study ancient religion, science, and the occult, but also that its principal establishment was as "an institute for military scientific research."<sup>25</sup>

Consequently, the Ahnenerbe scientists working on its various secret projects had an ideological basis for the more mundane scientific view that the "**Black Sun**" was but the extremely strong gravitational force exhibited by the large mass rotating around the galactic center.

23 De Lubicz, *Sacred Science: The King of Pharaonic Theocracy* (Rochester, Vermont: Inner Traditions International, 1981), p. 28.

24 Ibid., pp. 202-205.

25 Nuremberg Military Tribunal, Volume II, p. 189.



Ancient texts might be able to afford a key to the recovery of a lost science, a science very different from the ideologically condemned "Jewish physics" of relativity, but quite in line with the "Aryan" physics of vorticular spin polarization, quantum mechanics, and its mathematical prediction of a vacuum energy flux, or "[zero point energy](#)."

It goes without saying that the Black Sun symbolism formed a central doctrine to the pre-Nazi secret society, [the Thule Society](#). The symbol of the *Black Sun* was also adopted as an emblem for *Von Liebenfels' New Templars*.

[The swastika](#) itself, in this context, becomes not only a well-known symbol from ancient esoteric traditions, but also a talisman of ceremonial magic on a celestial scale, deliberately chosen to mirror the apparent rotation of a well-known constellation around the north pole of the earth's axis of rotation.

This whole concentration on quantum mechanics, black suns, action at a distance, and celestial rotation gave a strong ideological influence to Kammler's SS think tank, for as will be seen, *vorticular and non-linear physics* apparently became two of its primary theoretical and experimental focuses.



*The Symbol of the Black Sun Adopted by the Thule Society,  
Contemporary German Federal Law Forbids it to be Displayed*

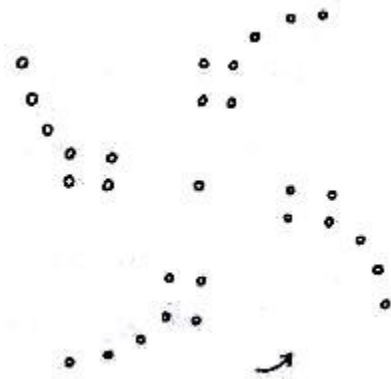

**The "Celestial Swastika": The Rotation of Ursa Minor, or the Little Dipper, around the Pole Star ca. 4000 BC**

Consider what all this means.

By war's end and his control of all secret weapons projects in Nazi Germany, **Hans Kammler** had attained the rank of SS Obergruppenfuhrer, the equivalent rank of a four star general, and only one rank below that of Himmler himself.

Given this high rank, it is thus not only possible but very probably that Kammler was one of the chosen "Knights" of Himmler's "round table", and thus it is probable that by the war's end Kammler had a deeply connected relationship to *the Ahnenerbe* and its occult activities. It may be in part for this reason that his dossier in the US government's archives remains classified to this day.

In any case, there is yet another odd fact, one that again potentially connects [Kammler](#) with the [Ahnenerbe](#). Heinrich Himmler, who viewed himself as having some sort of "psychic connection" with the famous mediaeval *German Holy Roman Emperor Heinrich the Fowler*, had the Emperor's remains dug up and reentered in the cathedral of the little town of Quedlinburg.

Quedlinburg is in the Harz Mountains, in the heart of the region that was the center of Kammler's empire of underground secret weapons plants and laboratories.

In any case, the Ahnenerbe in general and Himmler's Gruppenfuhrer initiates in particular did more than dabble in the patently absurd projects mentioned previously. It also mounted secret armed expeditions to South America to recover the well-known crystal skulls to investigate their optical properties. It ransacked ancient texts and the works of Sanskrit and other classical scholars for clues to "Vedic mathematics."

The SS inducted the *Muslim Grand Mufti of Jerusalem* into its ranks with the honorary rank of major, an act with its own dark, and contemporary, significance.<sup>26</sup>

The Ahnenerbe would mount an expedition to Tibet, and return with the only complete copy of the multi-volumed Buddhist Kang Shur to reach the West, a collection reputedly containing much lost information from the pre-classical, ancient "atlantean" world.

26 Sebottendorff, for example, one of the occult figures lurking in the background of the secret societies that had connections with the early Nazi movement, praised Islam's "vitality" and congruence with Nazi ideology.

## D. The Will to Power as the Paradigm of "Occulted Science" and Nazi Secret Weapons Programs

The quest of the SS to investigate the scientific basis of occult notions, no matter how bizarre or flawed those notions were, is thus itself an integral component of Nazi ideology and is philosophical background in German romanticism and orientalism.

It is Adolf Hitler's personal "will to power that betrays the interest of a potential occultist" so much so that this factor - so prevalent within the occult itself - "has never been given its proper due"<sup>27</sup> especially in connection to secret weapons research and the Kammler Group's "think tank."

Hitler himself described this ideological locomotive in no uncertain terms:

"A new age of Magic interpretation of the world is coming, of interpretation in ten of the Will and not the Intelligence."<sup>28</sup>

27 Sklar, *op. cit.*, p. 49.

28 *Ibid.*, p. 57.

In this, he may be seen as reaching back to the lingering effects within German culture of the philosophy of Arthur Schopenhauer's *The World as Will and Representation*.

The title speaks for itself. It is significant that the mastermind behind Nazi geopolitics and himself a convinced occultist, General **Karl Haushofer**, was an avid scholar of Schopenhauer.

It is this connection to *Will*, rather than to *intelligence*, that points the way to the connection to physics in general, and to quantum mechanics in particular, for it is in this seemingly upside down world, where the inverted order of cause and effect seems totally at variance with common sense, that the will itself plays a key role. And it was Heisenberg himself who of course formulated one of the most basic precepts of quantum mechanics that, looked at in this way, is but a precept or doctrine of sovereign will: the Uncertainty Principle.

Briefly put, this scientific law states that on the scale of the very small sub-atomic particles that form the subject of its investigation it is impossible to determine at one and the same time the position of an electron and its velocity. If a

measurement is taken of one property, the other will fade from view. It is this aspect that spelled the death knell for classical Newtonian mechanics, for it resulted in a physics that relied primarily on probability functions as a determinant of the reality in view.

"The reality in view," there's the point of contention, for this meant that even the probability functions we were ourselves predetermined by the attribute the experimenter decided to concentrate upon.

To that significant extent, the scientist himself predetermined the results of the experiment a priori, in an act of "sovereign will." In short, on the level of the very small, the scientist could, so to speak, "predetermine reality" simply by the way an experiment was configured. If one pressed this doctrine to one of its logical implications, then this meant that at a very fundamental level, physical reality and consciousness - Schopenhauer's "Will" - were intimately related.

One had only to study "paranormal" phenomena "scientifically" to grasp hitherto unknown "laws" of this physics. At the level of the very small, gravity, quantum mechanics and consciousness would have appeared to these physicists -free of the theoretical constraints of relativity - to pursue what must have been apparent to them: the profound link between the geometry of the fabric of space, the physics of the very small, rotation, and gravity, and perhaps of consciousness itself.

Thus by dint of its own cultural tillage, German philosophical romanticism, *Orientalophilia*, and physics had, by the time of the Third Reich, but to await the arrival of someone willing to fund and organize the pursuit of the new paradigm.

Hitler was its prophet, its "theorist"; Himmler was its "facilitator" the *Dark Eminence* who moved the pieces into position; and Kammler was its engineer, the *Black Magus* who coordinated it all on a day to day basis, and who built the "monuments", machines, and weapons for *the New Atlantis*.

Are these elements combined and contrived by war's end to give the Nazi war machine the prototypes and futuristic blueprints of weaponry far excelling even the hydrogen bomb for the destructive power and/or technological sophistication.

[Back to Contents](#)

[Back to Brotherhoods-Secret Societies](#)

## Chapter 12

### THE ALCHEMY OF ATLANTIS:

#### AN INVENTORY OF NAZI SECRET WEAPONS AND THEIR HISTORICAL PROBLEMATIC

"In 1939, with Professor Herbert Wagner of the Henschel aircraft company as a consultant, Fernseh undertook to develop a television installation that would enable pilots to control both planing bombs and rocket bombs after they were launched."

**Renato Vesco and David Hatcher Childress**

Man-Made UFOs <sup>1</sup>

<sup>1</sup> Renato Vesco and David Hatcher Childress, *Man-Made UFOs 1944 1994: 50 Years of Suppression*, p. 147.

There have been a host of books about Nazi secret weapons, detailing what is an incredible inventory of prototypical and futuristic weapons, from heat-seeking, wire-guided, radio guided, and even television-guided missiles, to tanks so gigantic that they are little more than impractical mobile pillboxes, to claims of the genuinely fantastic: flying discoid aircraft, or flying saucers, to fuel-air bombs, "death rays", particle beams, electromagnetic pulse weapons, "wind" cannon, and so on.

And beyond these, there were even more incredible long-range paper studies of nuclear powered aircraft and "space shuttles", gigantic solar mirrors in orbit to turn enemy cities and regions to toast, and a host of other paper projects almost too incredible to imagine. Usually dismissed derisively, these claims persisted in the literature, long after Adolf Hitler himself personally mentioned them, in what is usually seen as the demented ravings of a known *madman*:

We have invisible aircraft, submarines, colossal tanks and cannon, unbelievably powerful rockets, and a bomb with a working that will astonish the whole world. The enemy knows this, and besieges and attempts to destroy us. But we will

answer this destruction with a storm and that without unleashing a bacteriological war, for which we are also prepared.... All my words are the purest truth. That you will see!<sup>2</sup>

Hitler's alleged claims here could easily be dismissed, as well as those of the postwar neo-Nazi sympathizers who first broke the story of [Nazi flying saucers](#), as the farthest thing from "the purest truth." Dealing with a known sociopath and genocidal maniac such as Hitler and his followers, it became easy to dismiss such claims especially when there was no corroborating evidence forthcoming. Then [Renato Vesco's Intercept UFO](#) was published in the 1960 later republished, and then later republished again with additional material by [David Hatcher Childress](#) under the title *Man Made UFOs 1944-1994: Fifty Years of Suppression*.

**Vesco**, who unlike the neo-Nazi sympathizers who emerged after the war to first tell the story in the West German press provided a host of specifics, such as the names, types of weapons and laboratories and companies conducting the research on these advanced technologies. But again, as **Nick Cook** was to discover, the trail seemed to lead back to the same few sources, and it became a story impossible to corroborate.<sup>3</sup>

Vesco had mentioned the *British Intelligence Objectives Sub-Committee (BIOS)* reports as substantiation for his claims, but those were, at that time, mostly inaccessible, and in addition, "researchers had been through all the available... BIOS files with a fine-tooth comb and had found nothing..."<sup>4</sup>

2. Mayer and Mehner, *Das Geheimnis*, p. 97, the quotation was overheard by Italian officer Luigi Romersa, q.v. chapter 5, p. 97 of this book.

3. Nick Cook, *The Hunt for Zero Point*, p. 53.

4. *Ibid.*, p. 57.

Vesco couched his account of alleged Nazi "Fireballs" (the so-called *Foo Fighters* seen at the end of the war), within a tapestry of references to these other advanced missile projects undertaken by the Third Reich. But as researcher **Kevin McClure** put the case, Vesco's "technical" descriptions of the alleged Nazi devices behind the *Foo Fighters* sightings were based on "pseudo-technical descriptions" that originated "absolutely and only with Vesco."<sup>5</sup> Add to this Vesco's claims for "fuel-air bombs" and the story - Vesco's detailed references to scientists, companies and laboratories notwithstanding - became all too easy to dismiss once again.

But then came the German reunification and the resulting declassification of documents by the American, British, and German governments. The truth is not merely incredible, but staggering, and it poses host of historical problematics, as we shall see.

## A. The Missiles

A *Combined Intelligence Objectives Sub-Committee (CIOS)* report, number XXXII-125, running to more than one hundred and fifty pages, details not only "an experimental model of an additional thrust unit which was to be fastened to either the A4(V-2) or the A-9 to give an additional range,"<sup>6</sup> but also various "America Raket" projects for a guided missile with a range of 3,500 miles.<sup>7</sup>

These latter rockets, the report notes, with less than complete reassurance, "probably never progressed beyond the drawing board stage."<sup>8</sup> But additionally, there was a *V-3 weapon*, "a larger version of the V1 with an incendiary warhead instead of the (high explosive) normally used. Very little information is available concerning V3 control systems."<sup>9</sup> What, indeed, was this "incendiary warhead"? A thermite bomb? A fuel-air bomb? An actual atom bomb? The report is unclear.

5. Kevin McClure, *The Nazi UFO Mythos, Core 2: "Renato Vesco, Feuerball and Kugelblitz*, p. 5, internet published book, [www.magonia.demon.co.uk/abwatch/naziufo/naziufo3.html](http://www.magonia.demon.co.uk/abwatch/naziufo/naziufo3.html).

6. "German Guided Missile Research, Combined Intelligence Objectives Sub-Committee, G-2 Division, SHAEF (Rear), APO 413, XXXII-125, p. 5.

7. *Ibid.*, p. 6.

8. *Ibid.*

9. *Ibid.*, p. 7

As if this were not enough, a lengthy section of the report concerns a whole range of guided missiles being developed under the direction of Dr. Wagner for the Henschel firm. These included the HS-293-B, a rocket power glider with a wire guidance system,<sup>10</sup> the HS-294-A rocket powered glider "with torpedo" that included a "special device for blowing off fuselage rear section and wings as soon as body touches water surface, fuselage front section then cruising as torpedo under water," a small quantity of which were built for experimentation between 1941 and 1943!<sup>11</sup>

A lengthy section of the report, from page 139 to almost the end of the report, concerned the development of miniaturized television camera guidance systems for various missiles, including the well-known anti-aircraft rocket, the "WasserfaU" (Waterfall),<sup>12</sup> Many of these tests failed, but by the war's end, a successful test of the television-guided "Tonne" missile was conducted by German scientists for the Allies in Berlin, with the target being a photograph of a little girl's face. The test was successful, much to the impressed, and doubtless shocked, Allied observers.<sup>13</sup>

To this astounding inventory, one may add radio-controlled surface to air missiles - one of which sank the Italian battleship Roma on its way to surrender to the Allies - infrared heat seeking air-to-air and surface to air missiles, wire guided missiles and torpedoes, biological and chemical warheads for the V-1 and V-2, and possible fuel-air and atomic warheads as well.<sup>14</sup> In addition, the Heinkel and Messerschmitt companies were undertaking modifications of their He-177 and Me 264 heavy bombers to carry atom bombs. Where were these modifications being made?

In Prague.<sup>15</sup>

10.Ibid., p. 8.

11.Ibid., p. 9.

12.Ibid., pp. 139-150.

13.William Uricchio, "Envisioning the Audience: Perceptions of Early German Television's Audiences, 1935-1944, p. 1., <http://www.let.uu.nl/~william.uricchio/personal/SWEDEN1.html>.

14 .Q.v. Friedrich Georg, Hitlers Siegeswaffen, Band 1, pp. 128-143

15. Ibid.

## B. Prototypical Stealth (Radar Absorbent) Materials

But Hitler's boast overheard by **Luigi Romersa** included more than just a prototypes for the "smart" weapons that would become such staples of the American military for decades to come. It also included a claim to possess invisible aircraft and submarines. Surely this, at least, was fantasy? Not so. There exists a British Intelligence Objectives Sub-Committee (BIOS) report entitled "Production and Further Investigation of Wesch Anti-Radar Material, CIOS Black List Item 1 RADAR, BIOS Target No. 1/549," whose significance is rather obvious from its title.

The objective of this team was to acquire some 500 feet of this material for secret testing by the British Admiralty.<sup>16</sup> The report details the production of various RAM materials (*Radar Absorbent Material*) by the Germans,<sup>17</sup> via techniques that involved shredding and heating rubber, and combining zinc oxide, finely ground iron powder (the powder was ground into micro-spheres), which was all then pressed into sheets, and then transferred to press moulds, trimmed and heated under small pressure. This material was actually used on the hulls of some late Type XXI U-Boats, as well as on U-boat schnorkel devices, to scatter Allied radar to return distorted or indeed, no radar signals.<sup>18</sup>

16. "Production and farther Investigation of Wesch Anti-Radar Material," British Intelligence Objectives Sub-Committee 1/549, Report 132, p. 4.

17.Ibid., pp. 5-6.

18. Ibid., pp. 5-7.



German Schnorkel Coated with Early "Stealth" Material

Yet another type of *RAM technology* was being studied by the Germans for its effects on electromagnetic wave propagation. As this is an important point that we will return to later, the report on this material is cited in full here:

Zeulenroda:

The following are the only war research activities engaged in: Measurements were made on materials for absorbing electromagnetic radiation. One of these materials consisted of spiral steel shavings imbedded in paraffin, which was named *EISENSPANE*. Another material tested was manufactured by I.G. Farben and was called *MOLTOPREN*. No papers were available on this work but the results were given from memory as shown in appendix B. The purpose of this work was for the concealment of submarines.<sup>19</sup>

I.G. Farben, and missing papers, once again. And submarine stealth was not the only thing the Nazis were after:

A large price was offered by the German Government for the development of "Schwarzflugzeug" /Black airplane/, a non-reflecting material for use on aircraft.<sup>20</sup>

As we shall see, this research may have paid unexpected dividends to the German secret weapons research project. In any case, the existence of actual "protostealth" schnorkel devices on late war German U-boats attests to the success of some of these experiments.

This report also corroborates yet another allegation, often derisively dismissed by mainstream researchers, that in May of 1945, a small flotilla of the new Type XXI U-boats, with their revolutionary hydrogen peroxide underwater "turbine" propulsion allowing extraordinary undersea cruising speeds, met, and annihilated, a flotilla of British destroyers.<sup>21</sup>

19. *Ibid.*, p. 57.

20. *Ibid.*, p. 63.

21. Q.v. Henry Stevens, *The Last Battalion (German Research Project)*.

The allegations included the German use of new types of wire-guided, and magnetic proximity torpedoes.<sup>22</sup> At least one corroboration of this strange encounter occurs in the BIOS report:

Vierling has heard of electrical homing devices for torpedoes and their firing by a proximity effect. Torpedoes used magnetic fields varying at about 500 cycles per sec. Torpedoes were built by AEG in Berlin. Some work was done also at Gdynia. These torpedoes were reported to have sunk 12 Destroyers in one engagement in Arctic waters.<sup>23</sup>

22. Q.v. Henry Stevens, *The Last Battalion (German Research Project)*.

23. "Production and further Investigation of Wesch Anti-Radar Material," *British Intelligence Objectives Sub-Committee 1/549, Report 132*, p. 63, emphasis added.

## C. Computers

The Allies, as is known, perfected early digital computing machines during the war, which machines were instrumental in breaking the "unbreakable" German *Enigma machine's ciphers*, but also of incalculable value in assisting the Manhattan Project engineers with difficult calculations needed for the atom bomb. In some rarely encountered but sophisticated versions of the Allied Legend, this constitutes another reason for the German failure to develop truly long range rockets and, of course, the atom bomb. But here too, the declassified reality is quite at odds with the postwar spin.

A computing machine was used at Gottingen for researches in airplane stability and ballistics. Machine could solve equations mentioned in two or three minutes with errors less than 3%. Only one such machine has been made. It uses ordinary vacuum tubes, a multiplying principle and two cathode ray tubes, one of which has a spiral scan. One tube draws the curve which is the solution and the other indicates the complex roots of the solution.<sup>24</sup>

24. *Ibid.*

The Gottingen computer, however, appears not to have been the only computer designed and built in the Third Reich. Indeed, since the reunification, reports and actual photographs have surfaced of an enormous, "Eniac" sized computer built by none other than the Deutsche Reichspost.<sup>25</sup> The question is, why would the postal service need such an enormous, and expensive, computer? One reason has already been encountered in part one: such a computer would have been invaluable to the research that Baron **Manfred von Ardenne** and Dr. **Fritz Houtermans** were conducting for the Reichspost on the atom bomb, and for running the difficult calculations of neutron free path and cross sections that required.

25. Edgar Mayer and Thomas Mehner, p. 188

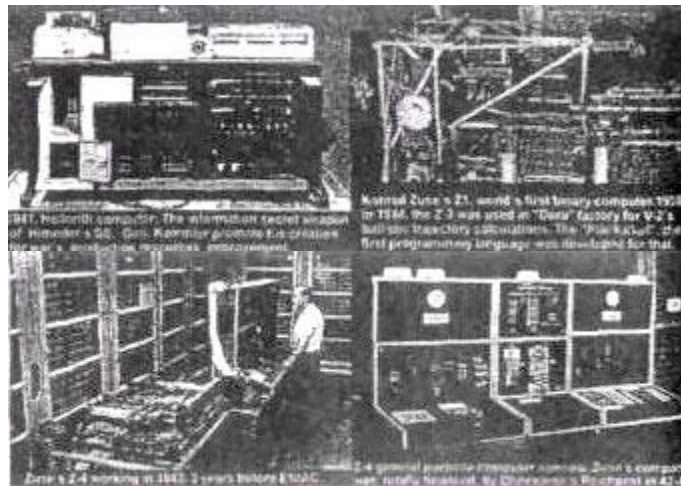

**The Reichspost's Computer**

## D. The "Superbombs"

As we have seen, before the curtain of silence and spin came down after the war, a number of small articles appeared in the Allied press about the actual state of German atom bomb research. One of these was an article that appeared in the *Evening Standard* on August 7, 1945, one day after the Little Boy atom bomb was dropped on Hiroshima.

It is worth citing this article in full:

## GERMANS TIMED ATOM BOMB FOR OCTOBER

The Germans had an atom bomb which would have been ready by October.

A colossal blast effect was claimed for the German bomb. It was said it would wipe out everything inside a radius of six miles, said B.U.P. to-day.

The German atomic plans were uncovered four months ago, when an Allied search party walked into a small silk factory at Celle, north of Hanover.

A laboratory of two rooms was buried away in the heart of the factory. A famous research scientist was still at work. He was flown to Britain the same day.

This man, with others, had been working on the atom bomb for months. The Nazi Government poured out money on it. Apparently they did not expect immediate results.<sup>26</sup>

There are a number of disquieting things about this article. First, one gains the impression from the report that the "laboratory" was not even known to the Allies until the factory was occupied. Second, there is already evidence of a "spin" in the report, as the German program is understood to have been underway for only a few "months." But the final and most unusual thing is that its blast effects, some 6 miles radius, or 12 miles in diameter, is far beyond the blast damage radius of even a large atom bomb, much less a fuel air bomb. The only known weapon with this extraordinarily sized blast radius is a *fully-fledged hydrogen bomb*.

<sup>26</sup> Mayer and Mehner, *Hitler und die „Bombe“*, p. 51, emphasis added.

We have seen in part one that Professor **Lachner** of Vienna maintained that the German atom bombs were deliberately intended by the Nazis to be used as the detonators for hydrogen bombs. But was there sufficient basic theory for the Germans to have thought of the hydrogen bomb at that early stage?<sup>27</sup>

<sup>27</sup> It should be recalled that Dr. Edward Teller actually first thought of, and proposed to the Allies, the hydrogen bomb in 1944.

### 1. The "Molecular" Bomb: The Hydrogen Bomb?

The idea of a "Superbomb" was first patented prior to World War Two in Austria, and a modification of the idea was patented in Germany in 1943.<sup>28</sup> Its inventor, Dr. Karl Nowak, explained the reason for his invention as being to create a superbomb without the radioactive fallout effects that were evident from atomic and thermonuclear explosions!<sup>29</sup>

In other words, the Nazis were already looking past the thermonuclear age toward the creation of second and third generation weapons systems that would give the same offensive and strategic "punch" but without the side effects! In theory, the bomb is workable, but was way beyond the technological capabilities of Germany, or any other power, in that time period. Basically, the idea was to create a state of matter in which, through ultra-low temperatures approaching absolute zero, matter would be super-compressed.

The idea was then to detonate this material, subjecting it to sudden stress and heat, to create a sudden and massive expansion and explosion, and therewith, an enormous, H-bomb sized blast.<sup>30</sup> Thus, there may have been a basis in actual German secret research for the incredible claim of the Japanese military attaché in Stockholm's 1943 report to Tokyo that the Germans were investigating the properties of super-dense matter for weaponization.

<sup>28</sup> German patent 905.847, March 16, 1943, cited in Mayer and Mehner, *Hitler und die „Bombe“*, p. 159.

<sup>29</sup> Ibid., p. 159.

<sup>30</sup> Ibid., p. 158.

### 2. The Fuel-Air Bomb

At the "small end" of the "bombs of mass destruction scale," however, there are equally baffling, and problematical, assertions regarding Nazi research into the fuel-air bomb, the only known conventional explosive device with enough



power to produce the blast and heat effects of a small "tactical" nuclear weapon. It goes without saying that today's "tactical nuke" would have been World War Two's strategic weapon.

Once again, the first allegations of this type of bomb did not come with Gulf War One in the early 1990s, but with Renato Vesco. And his claims there, as elsewhere, were quietly ignored. But once again, declassification has verified his assertions, and to an extraordinary degree:

### **(g) Liquid Air bomb**

As the research on the atomic bomb under Graf von Ardenne and others was not proceeding as rapidly as had been hoped in 1944, it was decided to proceed with the development of a liquid air bomb. Experiments using ordinary powdered coal were not at all successful, but extremely good results were obtained from a mixture consisting of 60% finely powdered dry brown coal and 40% liquid air. The technical man responsible for this work was Dr. Zippelmeier.

The first trial was made on the Doberitz grounds near Berlin using a charge of about 8 kg of powder in a thin tin plate container. The liquid air was poured on to the powder, and the two were mixed together with a long wooden stirrer. Kreutzfeld did this himself, and was present at the ensuing test. In an area of radius 500 to 600 meters trees, etc. were all completely destroyed. Thereafter the explosion started to rise and only the tops of the trees were affected, although the intensive explosion covered an area 2 km. in radius.

Zippelmeier then had the idea that a better effect might be obtained if the powder was spread out in the form of a cloud before the explosion. Trials were made with a paper container impregnated with some waxy substance. A metal cylinder was attached to the lower end of this container and hit the ground first, dispersing the powder. After a short time interval of the order of 1/4 second a small charge in the metal cylinder exploded and ignited the dark funnel shaped dust - liquid air cloud. The bombs had to be filled immediately prior to the departure of the aircraft.

Bombs with charges of 25 and 50 kg. of powder were dropped on the Starbergersee, and photographs of the explosion were taken. Standartenfuhrer Klumm kept a photograph of the result and showed it to Brandt (Himmler's personal adviser(sic)). The intensive explosion covered an area 4 to 4.5 km radius, and the explosion was still felt on a radius 12.5 km. When the bomb was dropped on an airfield, much destruction was caused 12 km away, and all the trees on a hillside 5 to 6 km away were flat. On a radius of 12.5 km. only the tops of the trees were destroyed.<sup>31</sup>

Several important considerations are worth mentioning here. First, note the truly massive size and area of devastation caused by the relatively small fuel-air bomb, for the area covered by the second test is commensurate with the blast from a large atom bomb: 6 kilometers' radius. Second, note that Zippelmeier has had a similar insight to Dr. Nowak's "molecular bomb": compression of material and then rapid dispersion over an area prior to detonation.

This is only one step short of a modern fuel air bomb with its chain molecules and electrical, instantaneous, rather than slower chemical, detonation. So in other words, regardless of whether or not the Nazis actually detonated atom bombs during World War Two, they did have a *weapon of mass destruction* as powerful as an atom bomb, and one that did not have radioactive side effects. Moreover, the weight of this bomb, while large, was within the capabilities of existing German bombers to carry. Finally, it is to be noted that this test took place under the direct auspices of the SS, Himmler's representative himself being present for it. And that would place the weapon firmly within the orbit of Kammler's "think tank." But possession of a fuel-air bomb by Nazi Germany now raises some important historical problematics.

<sup>31</sup> British Intelligence Objectives Sub-Committee, "Information Obtained from Targets of Opportunity in the Sonthofen Area," BIOS Target numbers C 28/8.211, C 25/549, C 6/137, C 30/ 338, C 4/268, C 22/2182, C 21/601., pp., 4

## **E. The Historical Problematic:**

German possession of even a prototype fuel-air bomb during World War Two causes a number of historical problems, and it is worth considering them and their implications.

### **1. The Cold War**

First, the test of such a device during the war would give lie to the contemporary "public" history of the fuel-air bomb, since they are only supposed to be the offshoot of American thermonuclear research and dating from the early 1980s.

Doubtless, the modern fuel-air bomb is nothing like the early German prototype, with its chain molecules and simultaneous electrical detonation, it is a lighter, and much more powerful device.

Second, if the technology existed for such enormous conventional bombs capable of reaching strategic large scale destruction on the order of small atom bombs, why were untold billions spent on much more expensive atomic and thermonuclear bombs, whose side-effects included deadly radioactivity, and why was the charade continued for so long? The existence of such weapons indicates that at some very profound, and little appreciated, level, the Cold War was a partial sham.

Third, the basic idea for such a weapon had, in fact, been explored by Austria (prior to its annexation by Germany), and then subsequently both by Italy and Germany in the years immediately prior to the war. The idea is simple, and the effects obvious. So why did it take this long to obtain the weapon? Or is there a history that has not yet come to light? Given what we have already encountered in part one regarding allegations of the German use of some weapon of extraordinary strategic explosive power on the Eastern Front, it seems likely that some similar type of weapon was already in use. The Zippelmeier test may thus only have been a test, not of the concept itself, but of how large of a weapon could actually be made. The results, as have been seen, were probably beyond even the Nazis' wildest destructive dreams.

## 2. The Alchemy of Atlantis: the "Mission Brief" of the Kammler stab

But what do all these fantastic projects indicate about the nature of German secret weapons research? We may draw a number of conclusions from the evidence presented thus far, and in so doing, speculatively reconstruct the "mission briefing" of the secret weapons think tank being run by Kammler's SS Sonderkommando:

- (1) Overlapping technologies were to be developed that could be employed in across a wide variety of various weapons systems (Stealth and RAM technology, etc);
- (2) Every available method for the creation of prototypical "smart weapons" was to be pursued (wire, radio, and television-guidance systems), i.e., German technological and engineering competence were to be exploited to the maximum;
- (3) This technological competence was to be pursued in (then) unconventional ways and combinations to create not only new weapons, but a new doctrine of warfare;
- (4) The first generation of these weapons were then to be extrapolated upon, and second and third generation technology trees and long range goals mapped out;
- (5) The ultimate quest was for the attainment of weapons of mass destruction beyond the acquisition of atomic and thermonuclear weapons;
- (6) Post-nuclear systems were then to be developed ideally, and initial research on those systems undertaken; and finally, as we shall see,
- (7) Every known theoretical principle of physics was to be pondered and extrapolations for weaponization theorized, and, to the extent possible, experimented upon and utilized.

In other words, the Kammlerstab's mission brief was to think "outside the box" entirely, even if that meant outside the box of Nazi party ideology, or, when it suited it, inside it. The basis was the will to power, by whatever means possible.

## 3. Whose Military-Industrial Complex?

All these considerations raise a final problematic, and one so obvious that I hesitate mentioning it, since others have before, only to be dismissed or not taken seriously. President **Eisenhower**, as he was leaving office, gave his celebrated warning to the American people about the spiritual and cultural dangers of "the military industrial complex." With the influx of Nazi "*Paperclip*" scientists, many if not most of whom - including Dornberger, Oberth, and Von Braun - were members of Kammler's "think tank", this warning by someone in the know must surely be interpreted differently than current standard explanations.

Having fought the world's first "military-industrial complex" and doubtless seen at least some of its extraordinary inventory of weapons and theoretical papers, President Eisenhower is surely raising another ominous, though overlooked, specter: *Just whose military-industrial complex is he really warning about?*

What possible spiritual and cultural dangers were there to the American people from good old American companies like Boeing, DuPont, Lockheed, Hughes, and so on, unless, in importing ex-Nazi scientists and their unusual methods and insights and experimental results (often achieved at the cost of enormous human suffering), we inadvertently imported an underlying ideology at variance with traditional morality.

[Back to Contents](#)

## Chapter 13

### QUANTUM NUMEROLOGY AND VORTICULAR PHYSICS, NAZI STYLE

"And look what happened next. No sooner had people started showing an interest in Schauberger again than a man with clear ties to the US intelligence community turns up on his doorstep, tempts him over to the United States and shuts his operation down - permanently."

#### Nick Cook

[The Hunt for Zero Point](#) <sup>1</sup>

The bewilderment of Reichminister of Armaments **Albert Speer** when confronted by prosecutor Jackson's allegations of a German chemical weapons test of extraordinary power near Auschwitz is not an isolated instance.<sup>2</sup> Bewilderment seems to be the normal state of mind when confronted by the even more sensational allegations that have percolated through the press and UFOlogy journals since the war's end of Nazi development of prototype "flying saucers." How could anything so outlandish be true, much less be publicly reported?

<sup>1</sup> Nick Cook, *The Hunt for Zero Point*, p. 227.

<sup>2</sup> In the light of the previous chapter's information, another plausible explanation of Speer's ignorance of the weapon, as well as an explanation of what the weapon might have been, now present themselves, for a fuel-air bomb would fall well within the parameters of the test described by Jackson, and since, once again, the test occurred under SS auspices, it is not surprising that Speer did not know of it.

A starting point for entry into this much-maligned aspect of UFOlogy is what German physics actually was doing prior to and during the War under the Nazis. Much has been written of the deleterious effects of Nazi ideology on banning "Jewish physics," i.e., relativity, from German science, so this will not be covered again here.

This left quantum mechanics as the only genuine physics that could equally be claimed to be "Aryan" and pursued by Nazi physicists with a vengeance.

**Quantum mechanics**, in the state in which it then existed, could be summarized as having the following emphases and implications for the German scientists involved:

(1) The rejection of relativity meant to a certain extent that the pre-relativistic idea of an *aether lumeniferous* regained some currency, via its quantum mechanics version of zero point energy or vacuum flux. German scientists were therefore not free to pursue relativistic science, but were free to investigate the enigmatic properties of this new "quantum aether." Indeed, with various esoteric and occult doctrines percolating in the background, such as the notion of "vril" energy, and Reichenbach's early and well-known experiments in the 18th century on "life force" energy, the Germans would have been positively encouraged by the underlying ideology to undertake experimental examination of its properties as far as existing technology would allow;

(2) Reichenbach's experiments, plus the implications of *Heisenberg's Uncertainty Principle*, may have influenced German scientists to posit a connection between consciousness, quantum physics, and this underlying "quantum aether". The strange Ahnenerbe experiments mentioned earlier would seem to indicate that some such experiments in consciousness were being undertaken;

(3) Pre-war standard physics papers by **Gerlach** had indicated connections between spin and resonance effects;

(4) The *paradoxes of quantum mechanics* had also become known, leading Einstein, Podolsky, and Rosen to posit "quantum loopholes" in relativity's own "velocity of light speed limit" for faster-than-light transference of information;

(5) One German physicist of some repute, O.C. Hilgenberg, a student of gravitation expert Walter Gerlach, had taken Gerlach's work one step further, as we shall see;

(6) German physicists thus had strong internal impetus as well as external ideological pressures to investigate the properties of rotating media and fields, especially since the results of Georges Sagnac's rotational version of the *Michelson-Morley experiment* were known to them;

(7) The Germans knew of Tesla's extraordinary claims for beaming electric power, as well as of his high voltage direct current impulse experiments which revealed superluminal electro-acoustic longitudinal wave forms;

(8) The Germans would likely have known of *E.T. Whittaker's pre-relativistic papers*, which were a mathematical study of such wave forms.

Given this series of known physical papers and experiments, and given the Kammlerstab's "alchemy" of combining technologies and concepts to seek underlying unifying principles and methods, might they have put all these together to come up with the beginning theoretical outlines of a physics completely different than the public consumption physics proffered since the end of the war, up to, and including the *26 dimensional monster* called "String theory"? If so, are there any indications that they did so, or were beginning to? While the indications in terms of actual papers are slight, those indications, coupled with the revelations that have come from Germany since its reunification, suggest that the answer to both questions is "yes."

## A. Gravity, Vortices, and Quantum Numerology

Dr. Ing. Ott **Christoph Hilgenberg** was a student of the renowned Nobel laureate **Walter Gerlach**, whose work in magnetic spin polarization in 1921 had earned him the Nobel Prize. Hilgenberg, however, while within the "mainstream" of physics, was not one to allow his mind to be constrained by conventional concepts, as any glance at his two little known, but quite unconventional and thought-provoking papers will attest.

In 1931 Hilgenberg published what may best be called an arcane paper entitled "*Gravitation, Tromben, und Wellen in bewegten Medien*," or "*Gravitation, Beats, and Waves in Moving Media*." The title itself is quite suggestive, for it is the first indication that, even before the Nazis, and after relativity, at least one serious and respected German physicist is still thinking of the old idea of an aether, but thinking about it in a way quite different from the *static aether concepts of the 19th century* that led to the famous Michelson-Morley experiment, and Sagnac's rotational version of it.

For Hilgenberg is thinking of a **dynamic aether**, spurred in part no doubt by the implications of Sagnac's version of the famous experiment. Hilgenberg's paper was arcane and abstruse in the extreme, advocating the idea of gravitation as a vertical ether sink. Thus, as in relativity, gravity was the consequence of a complex geometry, only in Hilgenberg's case, this meant that "mass" was a geometric result manifest, for example, in a rotating body's interior. This led Hilgenberg to propose the very unconventional idea that the earth - or any other such rotating massive body - expanded and contracted, in a huge wave-like pattern over time.

In 1938 Hilgenberg followed this paper up with a mathematical and theoretical physics tour de force entitled "*Quantenzahlen, Wirbelring-Atommodelle und Heliumsecherring-Aufbauprinzip des Periodensystems der chemischen Elemente*," a mind-twister that is no less impressive in English: "*A Quantum Number, Vortex Atom Model and Hexagonal-ring Construction Principle of the Periodic System of the Chemical Elements*."

**Hilgenberg** had developed the mathematics for a system of modelling complete atoms according to vorticular rotational principles of the now long-discarded aether!

The combined effect of these two papers and their mathematical and theoretical development allowed Hilgenberg to predict a number of effects completely at variance with relativistic physics, and long before similar observations in the late 20th century began to signal significant problems with the relativistic-Big Bang cosmology, e.g., heterodyning effects on light coming from a body moving toward the observer, or, to put it simply, why red-shift effects sometimes accompany bodies moving toward an observer rather than away from one.

Under Hilgenberg's influence, **Carl Friedrich Krafft** took this "vorticular quantum mechanics" one step further, and posited atoms as essentially a geometric or topological construct of the aether that acted as "ether pumps", taking in or giving off energy based on the rotations of the various rings of dynamic aether around them. He developed this notion even further by positing various combinations of vorticular, rotating geometries as the basis for the then known sub-atomic particles. Krafft, whose views were totally eclipsed by war's end with the victory of the Allies - which likewise might be seen as a victory of relativity - was left to self-publish his works in this strange world of "non-linear physics", which were duly and promptly ignored by the more conventionally minded linear physics of relativity and its proponents.<sup>3</sup> But is there

any indication that all this theory about the vorticular and rotational aspect of a dynamic aether was ever pursued beyond the stage of theory?

**3 No amount of explaining, however, can seem to quell the anti-relativist side of things for the simple fact that in most respects the theory of General Relativity has enormous predictive power, and therefore, scientific value and credibility. It is only recently that some crucial observations have arisen to challenge its assumptions.**

Indeed there is, but it requires a detour by way of a bit of aerodynamics, courtesy of Renato Vesco once again.

## **B. Disks, Boundary Layer, And Turbines**

**Vesco** maintained an unusual approach throughout the various reprinting of his book, namely, that German experimentation with disk shaped aircraft actually began as an experiment to transform the entire lift surface into the intake vent for a jet turbine. That is to say, on his view, the earliest German "saucers" were nothing more than standard suction aircraft, though admittedly of very unusual design. These experimental aircraft were further the offshoots of German experiments to suction the boundary layer from the lift surfaces of aircraft.

The "boundary layer" is that small layer - only a few molecules of air thick - of air that "sticks" to a lift surface, such as a wing, and, as an aircraft moves faster, this layer increases the drag on the lift surface, and therefore weakens its efficiency and requires more energy to move the craft. As speed increases and depending on the configuration of the wing itself, great turbulence can build up behind the wing as the result of the thickening of the boundary layer, increasing the aerodynamic resistance. "It seems clear, therefore, even to a layman in aeronautics that the objective should be to move the point of transition as far to the rear of the moving body as possible in order to minimize the expenditure of motive energy required to propel the body through the air. This is especially true in high speed flight, since the power required increases at about the cube of the speed."<sup>4</sup>

Thus, prior to the war British, American, and particularly German researchers concentrated their efforts to develop various methods to deal with this problem.

Various methods were tried and pursued during the war, including the use of micro-porous sensitized metal called "*Luftschwamm*" (literally, "air sponge") as both a lift surface and an intake vent for a jet turbine. The goal was simply to suction the boundary layer itself from the lift surface, thereby dramatically decreasing drag, and increasing efficiency and performance at high speed.

According to Vesco, the Germans gradually reached some intriguing conclusions in these experiments:

The first was that it was not advantageous to transform ordinary aircraft into planes with a controlled boundary layer because the suction principle was deprived of its best attributes and the difficulties of construction did not compensate for the limited advantages....

In addition, it was demonstrated that inasmuch as they were planning a special turbine-powered project, it would have been advantageous to combine the two mechanisms into a single whole by feeding the turbine with air taken from the wing orifices instead of by the means of the usual forward-ram air intakes.

....It seems, in fact, that by reworking the old experiments on "potential frictionless current," the German technical experts may in the final days have succeeded experimentally in reducing aerodynamic friction on appropriately shaped bodies to very low values.<sup>5</sup>

<sup>4</sup> Vesco and Childress, *Man-Made UFOs: 50 Years of Suppression*, pp. 188-189.

<sup>5</sup> *Ibid.*, p. 193, emphasis in the original.

This idea had also occurred to the British as well, but apparently the Germans had had no little success in combining micro-porous "sinterized" air permeable lift surfaces and turbine intakes, for a British postwar report,

"A.R.C. No. 9672: Notes on German Theoretical Work on Porous Suction - all the notes taken from the examination of German researches on porous materials (for which a special team of investigators had been formed)," were compared with similar British work done during the war.

The report, as Vesco notes, "still bears the label 'top secret.'"<sup>6</sup>

What the Germans were apparently trying to do was simply build a disk-shaped aircraft, the entire surface of which was both the turbine intake, as well as the lift surface. This was, so to speak, the "Mark I" flying saucer: a standard suction aircraft, albeit, with a very unconventional lift surface, which was one and the same as its fuselage and air intake.

However, Vesco maintained more in his book, namely, that the "Foo Fighters" - the strange balls of light that Allied and German pilots began to see accompanying their formations near the end of the war - were in fact an even more revolutionary radio-controlled anti-aircraft weapon, used to jam Allied radars via very small, ceramic-cased miniaturized klystron tubes, or to actually down Allied planes by firing ionized gases to short out, or even explode, an aircraft's ignitions or engines. In this respect, Vesco's assertions became more detailed, and simultaneously, more fanciful and easily dismissed. For one thing, Vesco claimed that these were secret German anti-aircraft weapons, a claim that seemed to fly in the face of absurdity, since the official history of their sighting never associated the loss of any Allied aircraft with them. In fact, they appeared quite harmless according to all standard versions of the history of their appearance.

Once again, only recently has the German perspective on "Foo Fighters" been verified by a February 1945 report called "*An Evaluation of German Capabilities in 1945*." This report, among other things, lists a German "phoo bomb" as well as atom bombs. Miniaturized klystron tubes, as well as German advances in silicon and germanium crystals, two elements essential in the making of semiconductors which in turn are the basis of the transistor, were actually under development as well.<sup>7</sup> Most of this research was burned by the Germans in the face of the Allied advance into the Reich, and the rest fell into American hands.

<sup>6</sup> Vesco and Childress, *op. cit.*, pp. 212-213.

<sup>7</sup> Henry Stevens, *Hitler's Flying Saucers: A Guide to German Flying Disks of the Second World War*, p. 75.

And this raises a significant problem, for the miniaturization of the klystron tube to a scale in some cases only a tenth as large as similar tubes in the Allied inventory, raises the specter of how far the Germans actually progressed in their *semiconductor research*. In any case, as researcher **Henry Stevens** notes, this bit of information provides the "missing provenance" to the origins of the transistor, and "explodes an argument made by the late Col. **Philip J. Corso** that "transistors were, at least in part, based upon [alien technology](#)."<sup>8</sup>

This will not be the first time we encounter a potential "German problem," as opposed to an "E.T. problem," with respect to Roswell and other celebrated crash recovery accounts.

One of the unusual aspects of Vesco's claims, and again, one that brought him under a certain amount of criticism, was his claim that an Italian engineer and turbine specialist named "Bellonzo" had been involved in the Nazi saucer projects. As no *Bellonzo* could be found, this assertion was apparently a fabrication, until one Dr. **Giuseppi Belluzo**, indeed a specialist in steam turbines, showed up to corroborate the story. Why is this significant?

Because in 1980 the German magazine *Neue Presse* featured an article about the German fluidics engineer Heinrich Fleissner. Fleissner was an engineer, designer and advisor to what he calls a "Flugscheibe" project based at Peenemuende during the war. It is interesting to note that Fleissner's area of expertise, fluidics, is exactly the specialty involved in investigating problems with boundary layer flow. Fleissner reports that the saucer with which he was involved would have been capable of speeds up to 3,000 kilometers per hour within the earth's atmosphere and up to 10,000 kilometers per hour outside the earth's atmosphere.

He states that the brains of the developmental people were found in Peenemuende under the tightest secrecy. .... What is of most interest to us here are three facts. First, that Fleissner worked at Peenemuende on a flying saucer project. Second, that a hint of this design has survived to this day. Third, the surviving design can be linked to photographic evidence of German saucer, circa World War Two.<sup>9</sup>

<sup>8</sup> Stevens, *Hitler's Flying Saucers*, p. 75. Stevens of course is referring to Corso's well-known and controversial book, *The Day After Roswell*.

<sup>9</sup> *Ibid.*, p. 90.

Let us pause to note that according to Fleissner there was a saucer project at Peenemuende and that it apparently involved the "suctioned boundary layer" concept we have already discussed. As we shall see, there will be an odd, little noticed connection that might corroborate the existence of this program when we examine the Roswell crash in the next part of this book.

Stevens continues with his summary of Fleissner:

Almost ten years after the war, on March 28, 1955, **Heinrich Fleissner** filed a patent application with the United States Patent Office for a flying saucer ([Patent number 2,939,648](#))....

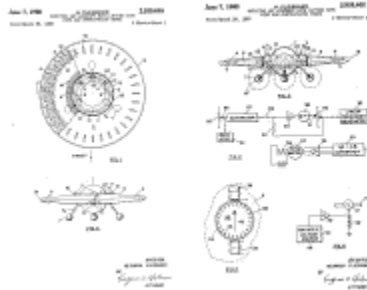

The engine employed by Fleissner rotated around the cabin on the outside of the saucer disk itself. It was set in motion by starter rockets... The difference is that this engine was really a form of ram-jet engine. It featured slots running around the periphery of the saucer into which air was scooped. The slots continued obliquely right through the saucer disk so that jet thrust was aimed slightly downward and backward from the direction of rotation.

Within the slots, fuel injectors and a timed ignition insured a proper power curve which was in accordance with the speed and direction of the saucer much like an automobile's fuel injection is timed to match the firing of the spark plugs. Steering was accomplished by directing the airflow using internal channels contained an rudder and flaps which ran alongside the central cabin. The cabin itself was held stationary or turned in the desired direction of flight using a system of electromagnets and servo-motors coupled with a gyroscope.<sup>10</sup>

But **Fleissner** was not awarded his patent until five years later! The question is, why the delay? One reason for the delay is that the joint Canadian-American suction-saucer project, *Project Silverbug*, was also under development at the same time. Fleissner's patent was incomparably superior. At about the same time as his patent was granted the Canadian-American project was canceled.<sup>11</sup>

10. Stevens, *Hitler's Flying Saucers*, p. 90.

11. *Ibid.*, p. 92.

But why was the Fleissner design superior? Perhaps because the patent detailed the way the earlier Peenemunde saucer was able to function both inside and outside the atmosphere. In short, the power plant for the unusual ram-jet was capable of utilizing both jet fuel for in-atmosphere flight, and once outside the atmosphere, the suction vents could be closed, and the fuel shifted to a mixture of liquid oxygen and hydrogen.

"Is this performance enough to impress the U.S. Air Force and civilian population of the late 1940s and early 1950s? The answer is clearly in the affirmative."<sup>12</sup>

But what has this to do with an Italian steam turbine expert? Very simply, because when the craft was in its,

"rocket mode, when the saucer is burning only liquid oxygen and liquid hydrogen, the products of this combustion are only heat and water. Another way to say heat and water is steam."<sup>13</sup>

And steam, of course, hisses, a sound sometimes associated with close observation of UFOs.

From this simple, though unconventional, configuration of known technologies, the Germans would have progressed by elementary science and engineering principles to the next, "Mark II," stage. How could such a craft's range be extended? The answer -one which likewise occurred to American physicist Thomas Townsend Brown - was that the jet turbine itself could be coupled with a large electrical generator to become a source of electrical power.

With sufficient super-cooling (remember Nowak's "molecular bomb"?) and sufficient electrical charge, even inert gases such as nitrogen, which forms the bulk of the earth's atmosphere, could be burned as fuel. Of course, while the theory is simple the engineering is monstrously difficult, but the advantages were plainly to be seen,

"A saucer which could gather its fuel along the way has one obvious advantage. It could stay aloft for days if not weeks."<sup>14</sup>

The next step, "Mark III," was imply to apply already existing German research in nuclear powered "conventional" craft to this unconventional airframe.<sup>15</sup> Was such a saucer ever actually built? An article by Jim Wilson in the November 2000 issue of Popular Mechanics discloses a project to design a chemical-nuclear powered saucer craft for long-duration orbital missions, a craft tipped with nuclear missiles and bombs.

12. Henry Stevens, *Hitler's Flying Saucers*, pp. 92, 95.

13. *Ibid.*, p. 97.

14. *Ibid.*, p. 99.

15. *Ibid.*, p. 101.

The project was allegedly based on wartime German designs, and its development was assisted by captured German personnel.<sup>16</sup>

16 Stevens, *Hitler's Flying Saucers*, p. 106.

All this, extraordinary as it sounds, is however nothing more than the unconventional blending of very conventional technology and ideas, a methodology we have encountered before in the German secret weapons black projects. What happens therefore, when these conventional technologies are not only combined in unconventional ways, but with the very unconventional physics that the Germans may have been developing? With this question, we are at the entrance into the "Mark IV" saucer prototypes, saucers based on combinations of turbines, vorticular physics, and field propulsion. With it, we are similarly at the very deepest secret levels of Kammler's "think tank."

## C. Viktor Schauberger: Rotational Physics and Extreme Temperature Gradients

The story of **Viktor Schauberger** (image right), an Austrian forester and naturalist, is well-known to any who have investigated claims of Nazi development of flying saucers. Yet, there are aspects of this story that have escaped even [Nick Cook](#) or meticulous researchers such as [Henry Stevens](#).



These aspects concern three key areas:

(1) His concern with "implosion", extremes of temperature gradients, and vorticular motion were coupled with his detailed study of ancient mathematical doctrines and "occulted physics" within ancient doctrines and philosophical texts. In short, [Schauberger](#) was the ideal candidate, from the SS's point of view, to lead a project involved with areas of physics and esoteric systems that were central to the SS ideology;

(2) His project was directly connected to the SS and, much to Schauberger's own moral disgust and distaste, was forced to use slave labor from concentration camps. Thus, what many have missed, is that this fact places Schauberger's saucer project firmly within the orbit of the Kammlerstab;

(3) Schauberger realized the implications for his "[implosion physics](#)" were such that a "super-super bomb" of unbelievable power could be constructed. This means, in effect, that quirky though some of Schauberger's terminology and ideas might seem from a conventional physics standpoint - he was, after all, a "naturalist" and self-taught physicist and inventor - his ideas were well within the framework being developed in quantum mechanics and the unusual "aether vortex" theories of physicists and engineers like Hilgenberg, Krafft, or even the great Gerlach himself.

In a nutshell, Schauberger's theories bring us to the very edge of what appear to be a wartime effort - a well funded, and deeply black effort - on the part of the SS to understand the relationship of the zero point energy, rotating fields, and gravity.

### 1. His Basic Conceptions

[Schauberger](#) began his little known and quite unconventional career as an "unorthodox physicist" as a forester for the Austrian government. One observation -a breathtakingly simple one -launched him on his career. One day **Schauberger** observed a trout in a clear, fast moving stream. The trout was stationary in the swift current, using a minimum of effort to remain in place: a flick of a fin here, a small movement of the tail there.



As he pondered this well-known, but little understood fact, he came to the realization that the trout was using far less energy to remain motionless than conventional physics would allow. After all, the fish should have been swimming like crazy just to stand still. But that was not all. Schauberger then wondered how the trout, again with so little apparent effort and expenditure of work, could suddenly leap from the water several feet, and land upstream against the current. Schauberger decided to study the phenomenon.

What he found was the fish seemed somehow to employ extremes of temperature to achieve their stationary place, or, conversely, to leap suddenly from the water against a swift current.

As molecules "condensed", they cooled, and gave off energy in the form of heat. But Schauberger added one factor that brought him into the realm of the unconventional vorticular physics that Hilgenberg, Gerlach, Krafft, and others in Germany were developing: whenever such "condensing" took place naturally in nature, it was accomplished by a spiraling motion toward the center of a vortex, a form of motion he called "implosion."

Schauberger speculated that, by deliberately forcing matter into such a motion, by deliberately compressing it via a spiral vorticular motion, matter might reach such a state that particles in atoms becomes "unglued" and transform into a new form of energy. In short, what Schauberger was proposing was a form of cool plasma, brought about by vorticular motion.<sup>17</sup> Schauberger supplemented this idea with all manner of study of natural examples of these types of spirals, well known to mathematicians to incorporate the Golden Section, and the Fibonacci sequence. In his own quirky way and terminology, Schauberger was talking about "cold plasmas" and cold fusion, concepts well in advance of any physics of his day, conventional or otherwise.

<sup>17</sup> Stevens, *Hitler's Flying Saucers*, p. 121; Callum Coats, *Living Energies: Viktor Schauberger's Brilliant Work with Natural Energy Explained*, pp. 30-66.

These ideas led **Schauberger** - like his more orthodox *quantum mechanics* contemporaries - to the conclusion that energy was relatively free and limitless if one only knew how to tap into it. And with extreme temperature gradients, rotating media and compression of matter to an intense plasma state - Schauberger thought he knew how. These ideas quickly brought him to the attention of a fellow Austrian who was interested in energy independence for his own reasons: Adolf Hitler.

In what surely must be one of the most surreal meetings ever held between an "orthodox mainstream physicist", a political leader, and an "alternative science" proponent, Schauberger was invited - summoned would be a more appropriate word - to Berlin for a private audience with Reichskanzler Hitler. A measure of the importance that Hitler attached to this meeting may be gleaned from the fact that once Schauberger had accepted Hitler's invitation, his diplomatic papers were expedited in one day.<sup>18</sup>

Callum Coats then describes the surreal meeting:

Hitler.... greeted him warmly as a fellow countryman, telling him that he had studied all the reports about Viktor's work thoroughly and was very impressed with what he had learned.

Thirty minutes had been allocated for the discussions, which Prof. Max Planck had been requested to attend as scientific adviser shortly before he was rudely deposed from his position as Privy Councilor. This exchange of views eventually lasted 1 1/2 hours, during which **Schauberger** explained the destructive action of contemporary technology and its inevitable consequences. He contrasted this with all the processes of natural motion and temperature, of the vital relation between trees, water and soil productivity, indeed all the things he considered had to be thoroughly understood and practiced in order to create a sustainable and viable society.

When Viktor had finished his explanations, Max Planck, who had remained silent, was asked his opinion about Viktor's natural theories. His response was the remarkable and revealing statement that 'Science has nothing to do with Nature.'<sup>19</sup>

<sup>18</sup> Callum Coats, *Living Energies*, p. 8.

<sup>19</sup> *Ibid.*, pp. 8-9.

Nothing further came of the meeting, but the lecture had undoubtedly made an impression on Hitler, if not on Max Planck. It was in 1943 that Schauberger's formal contact and work on a saucer project for the SS began.

(Schauberger) was declared fit for active duty and was inducted into the Waffen-SS, very much under duress. He came under the control of Heinrich Himmler, who forced him into research to develop a new secret weapon. Provided with

suitable accommodation at Schloss Schonbrunn, the nearby Mauthausen Concentration Camp to supply the workforce of prisoner engineers, Viktor was threatened with his life if he did not comply with orders and carry out this research.

In spite of these threats, however, Viktor put his foot down and demanded from the SS Command the absolute right to select the various engineers he needed. He further demanded that any technicians he chose were to be removed entirely from the camp, fed properly, dressed in normal civilian clothes and billeted in civilian accommodation, otherwise they would be unproductive. As he explained, people who live in fear of their lives and under great emotional stress could work neither consistently nor creatively. Surprisingly the SS agreed and so Viktor selected somewhere between twenty and thirty engineers, craftsmen and tradesmen from Mauthausen, to be accommodated in various houses near the plant.<sup>20</sup>

20 Coats, Living Energies, p. 11.

It is to be noted that the induction of **Schauberger** into the SS, the use of concentration camp labor, and the SS's behavior in allowing Schauburger fall latitude to pursue his project in the manner he wished, even as regards the housing of the concentration camp workers, are all classic signatures of *Kammler's "think tank" group*. In short, this is very strong evidence that Schauburger's team was one component of the Kammlerstab.

Few of the scientists and engineers Schauburger collected for his project understood what he was trying to construct. And it is difficult to get a measure of just exactly what Schauburger did accomplish, since all of his wartime German patents have simply disappeared, no one knows where.

## 2. His Disks and Turbines

It seems certain, however, that Schauburger's disks approached the boundary between the German "suction" saucers and field propulsion craft proper, as a glance at Schauburger's own postwar reconstructions of what these craft looked like will demonstrate. A postwar design exists for a home electricity generator based upon a simple, though quite unusual, jet turbine.

This "Tornado Generator" employed a turbine that in turn was made up, not of blades, but of hollow, antelope-horn-like spiraling tubes. Once air was forced into this turbine and its tubes, it was then compressed, via the spiraling motion of the air through the horns, until it escaped, expanded, and pushed the whole tube-turbine assembly along. This expanding air was then recirculated to the turbine, where it was again compressed, and so on.

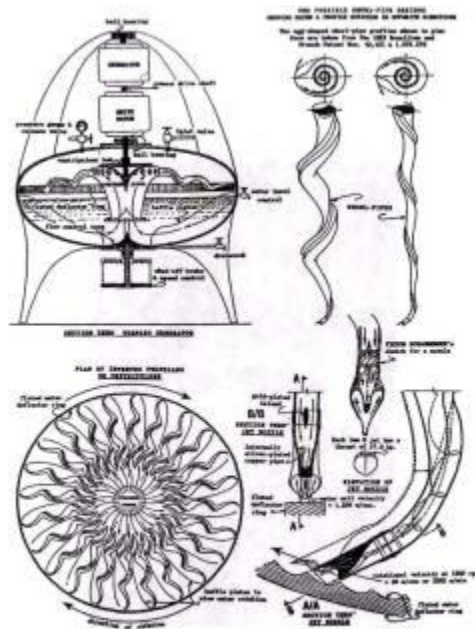

Schauberger's Postwar "Tornado" Generator

Needless to say, the construction of such a complicated turbine would have required the most exacting machining and engineering skills. There is every indication that a similar device or turbine became the basis of Schauburger's wartime research.

**Coats** reproduced the following series of photographs and schematics of Schauberger's wartime "Repulsine" saucer in his book *Living Energies*:

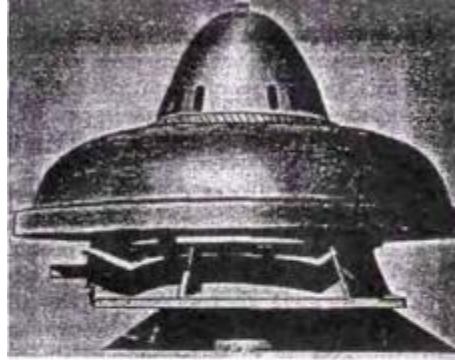

Photos of the "Repulsine"



Fig. 21.10



The "Compression" Turbine of the Repulsine 213

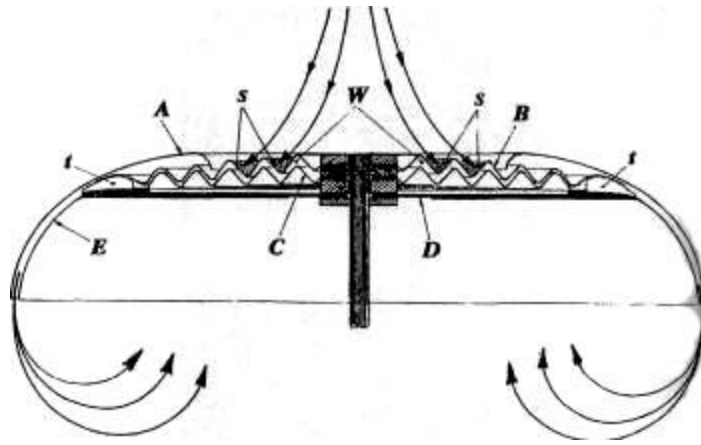

German Schematic of the "Repulsine" 214

**Nick Cook**, who followed the Schauberger trail via [Coats](#) and his research on the Austrian naturalist's strange ideas back to Germany, commented at length in his book as follows:

Something about this whole strand of development had conspired to make it the most classified form of technology in existence. Even more so than the bomb.

Unlike the bomb, however, this was a secret that had held for more than 50 years.

Days after the end of the war, US intelligence agents found [Schauberger](#) in Leonstein and apprehended him. Exactly as the (Nazi UFO) Legend had it, the agents, who were almost certainly Counter- intelligence Corps -the same outfit that had detained and interrogated Skoda's director Wilhelm Voss - were remarkably well informed about his entire operation. It was as if, **Schauberger** noted later, someone had guided them directly to him.<sup>21</sup>

<sup>21</sup> Nick Cook, *The Hunt for Zero Point*, p. 220.

Very few people would have been in position to familiarize US intelligence with the parameters of Schauberger's research or its exact location, but one of them would most certainly have been SS ( )gruppenfuhrer Hans Kammler.

**Cook** continues:

That night, back at my hotel, I applied myself to a study of the Schauberger effect that had been written up by a researcher called [Callum Coats](#). I had picked up a copy of one of his books at the Schauberger institute. In it, there was a description of what happened when a Repulsine was rotated at 20,000 rpm. The high rotation speeds appeared to cause the air molecules passing through the turbine to pace so tightly together that their molecular and nuclear binding energies were affected in a way that triggered the anti-gravity effect.

'A point is reached where a large number of electrons and protons with opposite charges and directions of spin are forced into collision and annihilate with one another,' Coats wrote. 'As lower rather than higher forms of energy and the basic building blocks of atoms, they are upwardly extruded as it were out of the physical and into virtual states.'

Virtual states? What the hell did that mean?

....'I stand face to face with the apparent "void", the compression of dematerialization that we are wont to call a "vacuum", ' Schauberger had written in his diary on 14 August 1936. 'I can now see that we are able to create anything we wish for ourselves out of this "nothing".'<sup>22</sup>

That is, the vacuum for Schauberger and his rotational, vorticular concepts, was but another "supercompressed" and "supercooled" state of matter.

In any case, one test of such a **Schauberger** saucer allegedly took place in Prague in 1945, breaking loose from its test anchor, it quickly flew upward hitting the roof of the building. Given the extraordinary latitude accorded to Schauberger by his SS controllers - doubtless up to and including **Kammler** himself - it is evident that "the German scientific leadership

was interested in implosion and in what Schauberger had to teach them but they did not necessarily want to be limited by the use of air to achieve these results. Instead, they may have wanted to use Schauberger ideas but actuating these principles with electronic components."<sup>23</sup>

22. Nick Cook, *The Hunt for Zero Point*, p. 221.

23. Stevens, *Hitler's Flying Saucers*, p. 128, emphasis added.

This will lead, as we shall shortly see, to the most fantastic projects of all in the Kammler Group's esoteric think tank. Whatever can be said, Schauberger's unorthodox approach to jet turbine design certainly, and by all accounts, was wildly successful, so much so that he became the object of a curious attempt by some Americans to develop the idea.

### 3. Implosion and the USA

As was seen, **Viktor Schauberger** and his unorthodox ideas came to the attention of US intelligence at the end of the war. And thus was launched the strangest episode in Schauberger's already strange career, the "American Episode".<sup>24</sup>

24. The best and most complete history of this episode is in Callum Coats' *Living Energies*, pp. 15- 28. My treatment of it here relies upon Coats, with the exception of my interpretation of its significance. Coats himself notes that the data for this period is precariously slim: "Before embarking on this last and lamentable chapter in Viktor Schauberger's life, I would like to state at the outset that significant and verifiable detail about it is extremely difficult to ascertain, mainly because all those involved, with the exception of Karl Gerchsheimer with whom I spent two days, have passed away in the interim. In whatever information is available concerning this tragedy, there is a profusion of conflicting statements, interpretations and timetables which, 37 years after the event, makes the unraveling of what precisely took place in this, for all concerned, abortive endeavour rather problematic." (p. 15)

The difficulties Schauberger experienced during his stay in America were similar to those he encountered first in Austria, and then later during his famous visit with Hitler and Planck.

First, being self-taught, he did not possess the physicist's technical language with which to express his ideas. Thus, he invented his own technical language, and often the translation between the two was difficult.

Second, Schauberger having already witnessed the theft and disappearance of his patents by the Nazis, was understandably reluctant to be completely forthcoming to his American "friends." Finally, Schauberger no longer had working prototypes of any of the devices he had built.<sup>25</sup>

Schauberger was first brought to the attention of a group of private American "investors" by one Karl Gerchsheimer, who emigrated from Germany in 1922, eventually settling in Texas and marrying an American wife in 1937. According to Coats, it appears that Gerchsheimer became involved with the US military during World War Two in its Counter-intelligence Corps, eventually becoming the man in charge of all transport, logistics, and accommodation for the American army of occupation in Germany after the war. He returned to the USA in 1950 and established a metal fabrication company, manufacturing a number of items for NASA under contract.<sup>26</sup>

25 Ibid., p. 15.

26. Ibid., p. 16.

In this capacity Gerchsheimer befriended wealthy American Philadelphia steel magnate **Robert Donner**. Gerchsheimer's familiarity with Schauberger's work, doubtless acquired during his Counter-intelligence years in Germany, and his disenchantment with Dr. **Von Braun's** rocket program, led him to propose to Donner that they visit Schauberger in Germany personally, to offer him the opportunity of private development of his "implosion" ideas. Gerchsheimer sold the project to Donner - an intense patriot - by maintaining it would ensure American technological dominance for decades to come.

A meeting in Bavaria was finally arranged between Gerchsheimer, Walter Schauberger (Viktor's son), and Viktor. Eventually squeezing out the European competition for his ideas with promises of large funding, Gerchsheimer was able to persuade Viktor to come to America. As part of the contract, negotiated for an American stay of three months, it was agreed that "Walter Schauberger, a physicist and mathematician, was to accompany his father and would be expected to stay for a year in order to assist in the scientific interpretation of Viktor's ideas for which there was often no recognized scientific terminology."<sup>27</sup>

Schauberger also stipulated that his trusted machinist, **Alois Renner**, who had collaborated with him in the construction of several of his devices, be brought to the USA as well. Gerchsheimer was of the opinion, however, that Walter Schauberger "neither knew nor understood much about his father's theories."<sup>28</sup> Eventually, the two Schaubergers flew to

Dallas, and then were driven to Sherman, Texas, where they were virtually interred as the "house guests" of Donner associate Harald W. Totten on his ranch.

Gerchsheimer quickly became disenchanted with Schauberger's ideas, which appeared to him to be increasingly so much gobbledygook. Having communicated these concerns to **Robert Donner**, who became concerned for the success of his project, Donner flew to Brookhaven's National atomic Research laboratories to seek expert scientific opinion. He secured the services of a technician who also spoke German, Eric A. Boerner, who was sufficiently familiar with the terminology of nuclear physics "to be able to translate and transmit any information to the scientific evaluators that the Schaubergers might provide."<sup>29</sup>

27. Coats, *Living Energies*, p. 18.

28. *Ibid.*, p. 19.

29. *Ibid.*, p. 22.

**Viktor Schauberger** spent about 10 days from August 20th to August 31st writing reports to Boerner. He had been instructed to write them in his own words, without regard to attempt to use "proper" scientific terminology. Because of the actual physical distance between the Schaubergers and Eric Boerner, and the intermediatorship of Gerchsheimer, the Schaubergers gained the impression that it was Boerner himself who headed an important particle accelerator project then underway at Brookhaven. And this in turn magnified their fears about the possible motivations behind the sudden American interest in their "implosion" concepts.

Walter Schauberger admitted that in the process of producing their reports, it dawned on them that a bomb could possibly be produced through implosion that was magnitudes more powerful than the hydrogen bomb. Assuming Boerner to be more influential than he was, Viktor and Walter became convinced that all the information they were supplying to him was being passed directly to the U.S. government and the military.<sup>30</sup>

While **Coats** himself downplays this potentiality, it is worth recalling that a similar "compression-decompression" principle lay behind the "molecular" bomb of Dr. **Nowak**, and hence, their concerns may have come less from a misunderstanding of Boerner's role, and more from an acquaintance with the work being done by the SS in Nazi Germany. In any case, I do not believe it is entirely fair to the Schaubergers to discount the possibility that the whole "private funding" venture via Robert Donner and Karl Gerchsheimer was not an operation designed to place into the hands of the US military and its research facilities the fundamental outlines of Schauberger's concepts.

In any case, a meeting was held on the Totten Ranch in early September 1958. Present were the two Schaubergers, Robert Donner, Boerner, and possibly Viktor Schauberger's machinist, Alois Renner. Based principally on the reports he had received, Boerner reported to the group that Project implosion was "a viable proposition." Boerner believed that "the solution of the problem of energy lay in the proper interpretation of Max Planck's equation  $E=h\nu$ , formulated in 1900, and the Friedrich Hasenohrl-Albert Einstein equation  $E=Mc^2$ ."<sup>31</sup>

30. Coats, *Living Energies*, p. 23.

31. *Ibid.*, p. 23. Coats rightly notes that it was first Hasenohrl who had postulated the equation in 1903 in the form of  $m=E/c^2$  (p. 29, n. 27). Hasenohrl's equation is slightly different than Einstein's which is properly  $E=Mc^2$ , where the capital M stands for a mass difference between two observed masses, rather than simply a lower case "m", which stands simply for mass. The point is picky, but important, as the mass difference as Einstein formulated it is crucial to the point he is developing in *Special Relativity*

Doubtless Boerner had in mind a rather remarkable paper that Walter had included in his reports, a paper that related these two fundamental equations, plus Kepler's Third Law of Planetary Motion.<sup>32</sup> In any case, with Viktor's health failing and his insistence to be returned to his beloved Austria as quickly as possible, the situation quickly deteriorated between the Schaubergers and Donner. Donner essentially held the two Austrians hostage until Viktor signed a contract handing over all of his ideas, inventions, and conceptions to the Donner-Gerchsheimer consortium. Only with considerable pressure was Donner even persuaded to provide Viktor with a German translation! Coats himself states:

I have studied this document myself and it does state in quite unequivocal terms that not only were all Viktor's models, sketches, prototypes, reports and other data to become the sole property of the Donner-Gerchsheimer consortium, but that Viktor was to commit himself to total silence on anything connected with implosion thereafter.... The deplorable upshot of all this, however, is that all Viktor's models, prototypes, drawings, detailed data, including Professor Popel's original report implying what might be termed "negative Friction" was an actuality, have remained the possession of the Donner-Gerchsheimer consortium. That this report was actually part and parcel of this project is confirmed by Viktor's reference to it in one of his reports to Boerner dated 23/24 August 1958.<sup>33</sup>

32 Coats, *Living Energies*, pp. 24-25 contains a synopsis of this rather remarkable idea. Needless to say, the paper is not the twenty-six dimensional monster of modern string theory.

33 *Ibid.*, p. 27.

What does all this mean? For one thing, it means that during the precise period that Nick Cook notes that all references to anti-gravity research began to disappear in the British and American Press, an American industrialist, with obvious ties to the defense and nuclear research agencies of the USA, had successfully obtained all of the papers of one of Nazi Germany's most deeply classified research projects scientists. For another, it seems to indicate that there may have been more to the science Schauberger had propounded than orthodox mainstream science will admit to, or that the contemporary military will allow to be discussed.

In any case, it is clear that Schauberger's ideas fit in quite well with the vorticular and dynamic aether ideas of the vacuum energy flux potential, or [Zero Point Energy](#), apparently under theoretical development in Nazi Germany both by "orthodox" and by less mainstream scientists. As we shall see, there is every indication that these ideas themselves were put to the test.

Before we turn to that however, it is necessary to examine yet another fantastic aspect of Nazi Science: the "Death Ray."

## D. "Death Rays ": An Unusual Installation at the University of Heidelberg

During World War One, as is well known, [Nicola Tesla](#) approached first the US, and then European military establishments with the idea for a "death ray", a high energy beam capable of melting "airplane motors" at some distance. Between the *World Wars*, in almost every western country, science fiction movies played on the concept, with one very popular movie with Boris Karloff, ever the quintessential "mad scientist", playing a crazed inventor tinkering with death rays and world domination. Similar "Buck Rogers" type gadgetry delighted movie goers in Britain, Germany, France, and Italy before the Second World War.

Then, as the *Nazi UFO Mythos* emerged, astonishing and specific claims began to be advanced, again by the same circle of a few disenchanting postwar Nazi sympathizers, of astounding beam weapons, of Motorstopmittel (Means to Stop Motors), a device that resembles modern [electromagnetic pulse weapons](#) designed to knock out electronic circuitry, of electromagnetic rail guns, and of a mysterious weapon the Germans were working on called a *Kraftstrahlkanone*, a "Strong Ray Canon". The device was first reported by [Henry Stevens](#).<sup>34</sup>

34 Henry Stevens, *German Research Project, The German Death Rays*.

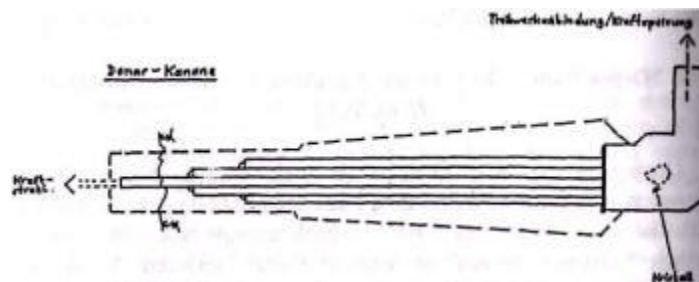

The *Kraftstrahlkanone* Schematic Reproduced by Henry Stevens

This odd looking L-shaped weapon comprised *some sort of crystal*, then a series of hollow tubes, each focusing whatever beam was generated to a narrower and narrower point, until it emerged from a small hole, with allegedly deadly effectiveness, though limited range. What the crystal was, we do not know. What sort of beam was generated, we do not know, though the hollow tubes in declining ratios would seem to indicate that it was some sort of acoustic wave, though why a crystal would have been used is unclear. For these reasons, the weapon was usually dismissed as a flight of fancy, and Stevens critiqued for reproducing it.

However, with very recall experiments and advances in physics, we are in a position to conjecture what the weapon may have been, and what principle the Germans may have discovered - decades early, to be sure - that may have been behind its operation. An experimental, and highly theoretical and mathematical paper entitled "[On the Existence of](#)

[Undistorted Progressive Waves \(UPWs\) of Arbitrary Speeds  \$0 < v < \infty\$  in Nature](#)," by **Waldyr A Rodrigues Jr.** and **Jian-Yu Lu** was published in October of 1997.

Investigating a class of *Undistorted Waves*, i.e., a class of wave forms that do not diminish in form or force over distance, they show that various solutions for these waves can be found within the standard equations for such waves.<sup>35</sup> If this paper were merely another mathematical swipe at relativity - demonstrating solutions to certain equations that the "relativity police" would issue a speeding ticket for - then it would be easily dismissible.

Unfortunately, the authors' main points are not the abstruse mathematical demonstrations and proofs, but rather, a method for generating such waves. First noticing that solutions for Maxwell's equations in a waveguide had both subluminal and superluminal solutions,<sup>36</sup> they went on to propose a simple method for generating and for measuring the velocities of such wave structures.

The method was called "Finite Aperture Approximation," basically, a method of squeezing acoustic or longitudinal waves through a very small hole, and observing the waveform interference pattern that emerged on the other side, and calculating the velocity, not of the wave, but of the interference pattern itself. If one knows the radius of the aperture and the strength and frequency of the pulse being squeezed through it, one knows the approximate depth of the Finite Aperture Approximation's resulting wave interference pattern.<sup>37</sup>

<sup>36</sup> Ibid., p. 4.

<sup>37</sup> Ibid., pp. 4-6, particularly Eq. 2.7 on p. 6. i.e., the scalar homogeneous wave equation, the Klein-Gordon equation, the Maxwell equations, and the Dirac and Weyl equations have such solutions, even in the vacuum. (Rodriguez and Jian-yu, "[On the Existence of Undistorted Progressive Waves \(UPWs\) of Arbitrary Speeds  \$0 < v < \infty\$  in Nature](#)," p. 1.

The results of experiments with at acoustic longitudinal pulses led the authors to conclude,

"these results... give us confidence that electromagnetic subluminal and superluminal waves may be physically launched with appropriate devices."<sup>38</sup>

Additionally, the authors of this unusual paper are "quite sure" that such a wave interference pattern "can be launched over a large distance."<sup>39</sup> Then come the bombshells:

If we take into account this feet together with the results of the acoustic experiments described in section 2, we arrive at tin- conclusion that subluminal electromagnetic pulses... and also superluminal X-waves can be launched with appropriate antennas using present technology ... Nevertheless, the electromagnetic X-wave that is an interference pattern is such that its peak travels with speed  $c/\cos(\theta) > 1$ .the question arises: Is the existence of superluminal electromagnetic waves in conflict with Einstein's Special Relativity?<sup>40</sup>

While this is not the place to summarize their lengthy mathematical critique of Special Relativity, based on their experiments, it is worth noting that the existence of this little known and recently discovered class of waves, or more specifically, wave-interference systems, "implies a breakdown of the Principle of relativity in both its active...and passive...versions."<sup>41</sup>

<sup>38</sup> Ibid., p. 7.

<sup>39</sup> Ibid., p. 18.

<sup>40</sup> Ibid., p. 21.

<sup>41</sup> Ibid., p. 36. The authors' critique of these two versions of Relativity and their dominance in theoretical and experimental physics is highly mathematical and, in a word, thought-provoking.

What emerges from a comparison of this paper and the alleged *Kraftstrahlkanone* is that apparently the Germans may have discovered and been conducting research into a similar, if not identical, phenomenon, a phenomenon that others would call a crucial component of **scalar physics**: electromagnetic wave-interference to produce a wave-system of superluminal and deadly force. They were, it seems, experimenting with some weaponized form of a Finite Aperture Approximation device. But why a crystal?

In part, perhaps, because as is well known, crystals under stress, and acoustic bombardment would be one form of stress, give off minute packets of electrical energy via the piezo-electric effect. But they also give off minute packets of sound, or "phonons", as well. But beyond this allegation, is there any other indication that the Germans were after exotic "post-nuclear" generation weaponry? There is indeed some indication that the Germans were involved with extensive research into "Tesla" technology and weaponry and other exotic particle beam technology at the University of Heidelberg.



As [Mayer](#) and [Mehner](#) report, there is in available documentation that some type of atomic research was being conducted at Ludwigshafen by none other than [I.G. Farben](#). But this research "had in reality more to do with the development of the so-called 'death rays'."<sup>42</sup> In a file dated December 1, 1944 on this research, it was noted that the work force was moved from Ludwigshafen to Heidelberg in July of 1943.<sup>43</sup>

This facility in Heidelberg was completely underground, being some 50 meters long and 25 meters wide, with a roof from 8 to 10 meters high, of .75 and 1 meter thickness. The entire bunker complex, as detailed in the diagram on the next page, consisted of a large parabolic reflector made of quartz, a "polytron," a power circuit running the circumference of the bunker, a storage area for various electrical equipment behind the quartz reflector, a generator and a transformer, a "stand" on which various targets for disintegration were placed, and a control-observation booth to the side of the stand. The quartz parabolic reflector was approximately one centimeter thick.<sup>44</sup>

42. Mayer and Mehner, *Die Atombombe und das Dritte Reich*, p. 73, my translation.

43 Ibid.

44 Ibid., p. 75.

An American intelligence report declassified only in 1998 described the experiments conducted with this and similar apparatus as follows:

Experiments: The experiments involved a large, elaborate atom-smashing apparatus, the main features of which were four "Spruehpole" (positive) and one "Fangpol" (negative), each about 6 m high. Liberated protons were conveyed through a quartz tube to the Spruehpole, from which they were "fired" at an object placed on a quartz plate up to 800 m distant. This resulted... in the complete disintegration of the object.

The first two experiments of this kind ... took place in Dec 43 and Jan 44. In one a 10 cm cube of steel (grade ST0012) was disintegrated within four-tenths of a second, The object in the second experiment was water, contained in a large quartz tube, tiled so that the "rays" would strike the largest possible surface. The water disappeared in two tenths of a second.

The most spectacular experiment was conducted early April 1944, when some 75 rats were made to disappear in the same way. The experiment was photographed from the quartz-enclosed observation tower, and PW claims there was no trace of smoke or flame, nor did any ashes remain on the iron plate. His explanation of this apparent violation of the laws of physics is that the rats were somehow reduced to a gas, which was absorbed by the iron plate.

PW's Evaluation: PW doubts that the principle involved in the experiments described above could be adapted to military use in less than two years. The apparatus is extremely complicated and far too large to be moved readily.<sup>45</sup>

This experimentation sounds like a much more sophisticated high voltage direct current form of Tesla's direct current impulse experiments, as well as of the unusual accidental disappearances of tools and equipment in a US Navy arc-welding facility that prompted an investigation led by none other than **T. Townsend Brown** during World War Two.<sup>46</sup>

45 Harald FStH, *Geheime Kommandosache- S III Jonastal und die Siegeswaffenproduktion: Weitere Spurensuche nach Thuringens Manhattan Project*, p. 107.

46 q.v. my *Giza Death Star Deployed*, pp. 212-214.

## E. Indications of Zero Point Energy and Scalar Physics Experimentation

There are a number of strong indications that the Germans were also experimenting with a variety of "Tesla" like devices that could, conceivably, also be called *Zero Point Energy* devices. In 1978, the British government finally declassified a British Intelligence Objectives Sub-Committee (BIOS) report on two curious circuits devised by German naval engineer and inventor, **Hans Coler** (or Kohler).

Entitled *The Invention of Hans Coler, Relating to an Alleged New Source of Power*," B.I.O.S. Final Report no 1043, Item No. 31, Summer 1946, this report consisted of tests and findings on two strange circuits conducted at the University of Berlin between the World Wars under the auspices of none other than Dr. **Schumann**, discoverer of [the Schumann resonance of the earth](#).<sup>47</sup>

47 The report is reprinted by the Integrity research Institute, 1422 K Street NW, Suite 204, Washington, D.C. 20005.

A mere glance will explain why the device attracted the immediate attention of the German Navy, which classified it as a possible source of quiet and limitless energy for submarine propulsion.

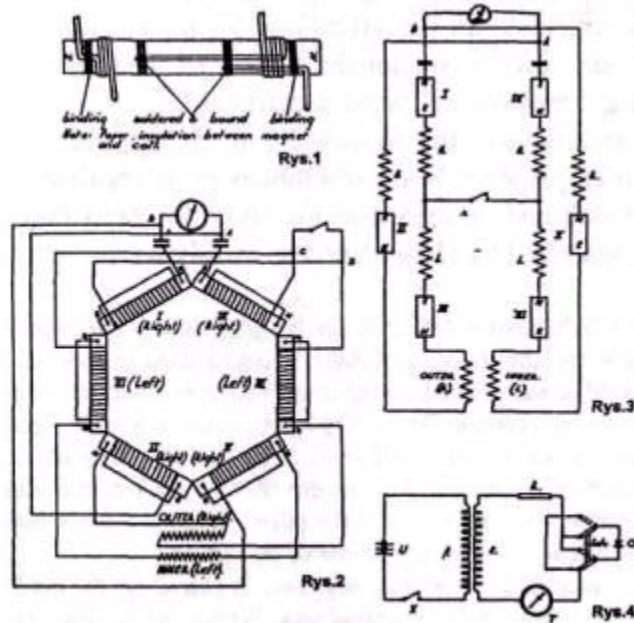

*The Coler Coil*

It will be noted that this hexagonal construction of coils and magnets and two "rotating" sub-circuits has absolutely no source of power. Yet, to the mystified Coler and Dr. Schumann, it nevertheless managed to produce, or better, transduce, power seemingly from nowhere.

Little is known how much farther the Germans took this device, or for that matter, how far the British took it for the two decades and a half after the war that they had to work on it until its declassification. What is unusual is that Dr. **Schumann** was involved with secret German research on "batteries" as late as 1943, and was subsequently brought to the United State as part of [Operation Paperclip](#). It was this same Dr. Schumann who had noted in 1926 that Hans Coler's device exhibited "no fault, hoax, or fraud on the part of its inventor."<sup>48</sup>

Such "free energy" devices seemed to have come very early to the attention of the leadership of the Third Reich - witness the meeting between Hitler, Planck, and Schauburger - and more especially to the attentions of the SS. Devices involving pulsed Tesla coils, suspiciously similar to Tesla's own "Impulse Magnifying Transformer" were constructed.<sup>49</sup>

<sup>48</sup> Henry Stevens, *Hitler's Flying Saucers*, pp. 168-169.

<sup>49</sup> *Ibid.*, p. 168.

One such device, the so-called *Karl Schappeller Device*, bears close scrutiny, since it bears resemblances to another device found by [Nick Cook](#) and described in his *Hunt for Zero Point*. This odd device is described by **Henry Stevens** as follows:

The *Schappeller device* is really composed of two separate units, the rotor and the stator. The stator is constructed as follows: its surface is round or ball-shaped, being composed of two half-shells of steel. These half-shells contain the internal structure and are air tight. Attached at each "pole" of each half-shell is an iron bar magnet, most of whose structure is internal. This means that the bulk of the magnet is inside the steel ball, one opposite the other. There is a space between the two bar magnets at the very center of the sphere.

Insulation, a ceramic material, is placed on the inside of the steel ball leaving a hollow central area. Within this hollow area and around the space between the magnets are wound two internal coils. These originate at the bar magnet poles and each terminate at the center of the sphere with a connection leading out of the sphere to the rotor. These coils are composed of a hollow copper tube filled with a special and secret substance called the "electret". Upon leaving the sphere the *electret* filled copper tubes are replaced by conventional copper wire.

An electrical connection is made from the outside surface of one pole to one pole of a special type of battery which is grounded at the other pole... This *electret* is a permanent magnet within the sphere... The actual composition of Schappeller's *electret* remains a secret but another *electret* has been made by Professor Mototaro Eguchi. It consists of carnauba wax and resin, perhaps also containing some beeswax. It was kept in a strong electrical field while baking slowly until it solidified.<sup>50</sup>

50 Stevens, *Hitler's Flying Saucers*, p. 177. 229

Before proceeding to how this device allegedly operated, it is important to note that this device bears strong resemblance in some respects to a device called "the Bell" uncovered by Nick Cook and his researches, covered below. Moreover, we shall see how the sum total of all these strange coils, spheres, and Bells will sound only familiar with devices alleged in two famous UFO crashes after the war.

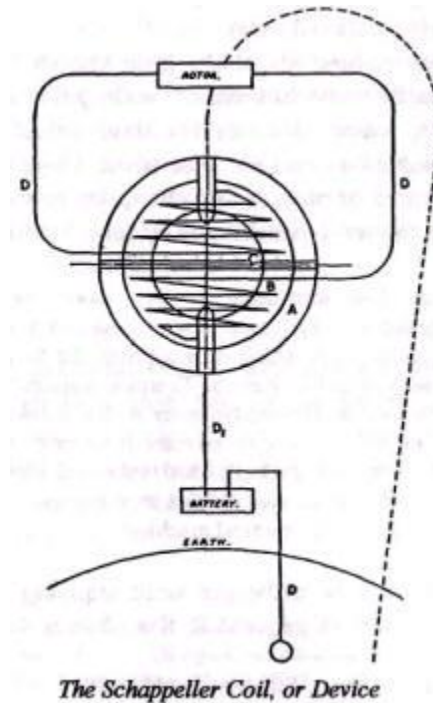

Returning now to the *Schappeller device* and its operation, for **Schappeller** the "neutral area", called the Bloch wall in a bar magnet, where the polarity is neither "north" nor "south", was of great interest and significance to Schappeller. In the Schappeller device it is noted that the empty area between the two magnets corresponds with this Bloch wall of neutrality.<sup>51</sup> It is this "neutral area" that is the area electrically charged by grounding when the device is put into operation. The result is a "new kind" of magnetism, a glowing magnetism in which, according to Schappeller's interpreters, electricity is stationary and magnetism is radiated.<sup>52</sup>

At the Bloch Wall, "the point of zero magnetism, no spin and magnetic reversal, is the point, so Schappeller theorized, energy enters and is radiated, in the form of gravity. Thus, according to one interpreter, gravity is a quadropole (four poles, rather than two poles), 360 degree radiated push."<sup>53</sup>

But most astonishing about the little known Schappeller were his extraordinarily revolutionary, and prescient, views on thermodynamics, views that, in his day, would have had him roundly dismissed as a crackpot, but some 35 years later, became an exciting new area of physics and chemistry research. That area is non-equilibrium thermodynamics and systems kinetics.

**Schappeller** had something to say about the Second Law of Thermodynamics. He said there was another and unknown thermodynamic cycle which runs opposite the Second Law. To name this idea we will call it "Reverse Thermodynamics". It is the reverse of the Second Law of Thermodynamics in that it leads to an increase in entropy. Not only is there an increase in order by there is an increase in cold! Schappeller... built his spherical device primarily to demonstrate the principles behind this Reverse thermodynamics. It was not designed as a practical machine.<sup>54</sup>

51 Stevens, *Hitler's Flying Saucers*, pp. 178-179.

52 *Ibid.*, p. 179.

53 *Ibid.*, p. 181.

Both Schappeller and Schauberger were implying a physics based, not on inanimate lifeless processes, the physics we have come to know, but on animate, creative processes but Schappeller's views on hydrodynamics were truly revolutionary, and some decades ahead of their time, until **Ilya Prigogine** won the Nobel prize in chemistry precisely for his pioneering work on self-organizing principles evident in systems driven to a high state of non-equilibrium in 1977.<sup>55</sup> The new paradigm, a breathtakingly simple, and yet far-reaching one, was simply that equilibrium had been replaced with non-equilibrium in physics, especially for systems analysis.<sup>56</sup>

55 q.v. Ilya Prigogine, and G. Nicolis, *Self-Organization in Non-Equilibrium Systems: From Dissipative Structures to Order Through Fluctuations*, (J. Wiley & Sons, New York) 1977.

56 I shall explore the significance of this paradigm in my next work on the Great Pyramid and the recent topological papers by Krasnoholovets and Bounias.

## 1. RAM Four-Wave Mixing

The German experiments with prototype Radar Absorbent Materials (RAM) was mentioned previously. In these experiments, according to Lt. Col. Tom Bearden (USAF, Ret.), that the Germans in late 1945 discovered that radar waves on such non-linear material resulted in the phenomenon of a superluminal, longitudinal "pressure" wave. In doing so, the Germans had brought the paradigms of physics far beyond the conventions of the "linear" physics that was being perfected in Allied laboratories, largely under the aegis of the Manhattan Project.

Consider the information that has been assembled thus far:

- (1) They did not reject a concept of **aether**, but rather, replaced the static nineteenth century idea with a dynamic aether;
- (2) This aether then gave rise to the forces and particles of conventional physics via various morphological combinations of vorticular, rotating structures, thus, its principle manner of thinking was non-linear and, in a word, purely topological;
- (3) These views were simultaneously allied both with occult doctrines of "primal matter" or life force or "Vril" or whatever one wishes to call it on the one hand, and with the construct called the Zero Point Energy that resulted from the equations of quantum mechanics, a very "German", "Aryan" science;
- (4) They were pursuing exotic ideas and technologies in unconventional combinations, the most salient features of which can be summarized as a concentration on:
  - (a) Pulsed high voltage and "focusing" effects;
  - (b) High rpm turbines and other such rotating devices;
  - (c) Non-equilibrium;
  - (d) Finite Aperture apparatus;
  - (e) Radioactivity and nuclear particle research;
  - (f) The effects of extremes of temperature on the density state of matter as a means of generating enormous explosive destructive power; and finally,
  - (g) The use of quartz and other crystals in generating some of these effects.<sup>57</sup>

57 Korsching's odd comment about artificial rubies at Farm Hall should be recalled in this regard.

With these thoughts in mind, we now approach what may be the most sensational experiment the Germans undertook during the War. The device was called simply, "The Bell", and its shocked and dumbfounded discoverer was Nick Cook.

## 2. The Brotherhood of the "Bell"

In the 1960s, a movie with Glenn Ford and a young Dabney Coleman, playing a small part as a government agent, was made. The movie was about a secret society allegedly at work behind the scenes in American society and politics, to manipulate research grants and control the direction of society. In the movie, Ford plays a member of this society who is served his "due bill" for all the favors the society has granted him, and forced to betray a Hungarian friend in order to deny that friend a crucial academic post and grant. His friend is named *Dr. Hlavaty*.

I have always thought that perhaps the movie's Dr. Hlavaty was not so fictional, being perhaps based on the brilliant Hungarian physicist, **Vaclav Hlavaty**, who attempted a six-dimensional solution to the Unified Field Theory that had

eluded Dr. Einstein. Whatever the truth of that hypothesis, it is perhaps interesting to note that the "[Brotherhood of the Bell](#)" seemed to exist for no other purpose than to suppress certain types of research, or at least, to keep it out of the public eye.

It should come as no surprise, then, that there was a "brotherhood of the Bell" during World War Two, for one of the most strange objects the Germans were experimenting on was a device that was known simply as "The Bell." So sensitive and secret was this device, that when it was evacuated from its underground secret laboratory in Lower Silesia prior to the Russian occupation of the area, the SS shot the approximately 60 scientists - doubtless on Kammler's orders - that were involved with this *strange object*.<sup>58</sup>

The Bell consisted apparently of two counter-rotating cylinders, and resembled a Bell in its general shape. It stood approximately 12 to 15 feet high, and was approximately 9 to 12 feet in diameter.<sup>59</sup>

58 Nick Cook, *The Hunt for Zero Point*, p. 187 For a fuller discussion of the Bell and its mysterious properties, consult my *Giza Death Star Deployed*, pp. 121-128.

59 Cook, *op. cit.*, pp. 191-193

Into this device, an unknown purplish metallic-liquid looking substance known only as "Xerum 525" or "Serum 525" was poured, apparently to be mechanically rotated at high speed, and possibly electrically rotated as well, by the device. The result was that organic objects placed within the field of the Bell swiftly decayed without putrefaction, decomposing into a *black goo*, and then finally, into dust, within a matter of hours, and not several weeks. So strong was the field that resulted from the Bell, that on its first test the technicians and scientists involved were all killed.

Subsequently, the Bell was operated only for one or two minutes at a time, and housing below ground in a room bricked and tiled with ceramic tiles, which were then covered in thick rubber mats. After each test, the mats were burned, and the room washed down by concentration camp inmates with brine.<sup>60</sup> When **Cook** was shown the installation in which the Bell was housed, he was also informed of its high electrical consumption.<sup>61</sup>

What was the mysterious "Xerum 525?" When I first read of this substance which had to be stored in lead lined cylinders, I first thought it sounded like a radioactive isotope of mercury, or perhaps some other radioactive material suspended in solution of some sort. More recently, allegations have surfaced concerning the neutron emitting properties of so-called "red mercury" or *mercury antimonate oxide*, supposedly a source for detonating thermonuclear warheads without the necessity for detonating an atom bomb, and a powerful conventional explosive in its own right.

Whatever the mysterious substance was, it seems clear that it was highly radioactive, and that the Germans were subjecting it to extremely high mechanical and electrical rotations to study the resulting field effects, effects that Cook's advisors could only qualify as "torsion" fields.<sup>62</sup>

These fields are thought by some contemporary physicists to have direct relevance to the study of gravity, and of time.<sup>63</sup> Close to the Bell's underground testing bunker the Germans had built a large concrete henge-like structure, in the pillars of which were high grade steel hooks, an obvious testing frame for what must have been an extremely powerful propulsion device.

What happened to the Bell? No one knows. Like **Kammler**, it goes completely missing at the end of the war, and its scientists, as already stated, were murdered to a man by the SS to keep whatever precious secrets it, and they, had uncovered.

60 Cook, *op. cit.*, p. 192

61 *Ibid.*, p.p. 182-183, 197.

62 *Ibid.*, p.p. 192, 194

63 In this regard it is perhaps interesting to note that, years prior to the publication of Nick Cook's book, well-known science-fiction-horror-thriller author (whose genre and style is so compellingly unique), Dean Koontz, published a novel called *Lightning*, the theme of which was a wartime German experiment with a time machine that, coincidentally (?) consisted of rotating cylinders!

But as we shall discover in the next and final part of this book, the Bell may have surfaced again under very public, if not bizarre, circumstances.

[Back to Contents](#)

## Chapter 14:

## THE ANTARCTIC SHANGRI-LA

"The Hitlers sat together on a couch in their suite....  
At about 3:30 P.M. Hitler picked up his 7.65 caliber Walther pistol...  
On a console was a picture of his mother as a young woman.  
He put this pistol barrel to his right temple and pulled the trigger."

### John Toland

Adolf Hitler.<sup>1</sup>

<sup>1</sup> John Toland, *Adolf Hitler*, Volume II, p. 1002.

Adolf Hitler was as mythical in death as he was brutal and large in life. Because of the curious circumstances of his suicide, and the inability of the wartime Allied powers to cooperate on an extensive and through proof that he did die, a whole mythos of his survival grew up after the war, and continued for some many years afterward.

Betrayed even by Himmler himself, who had secretly begun peace negotiations with the western Allies through the Swedish government, and with one time designated "Deputy Fuhrer" and former party chief Rudolf Hess in a British prison cell, and his designated replacement Reichsmarschall Goring claiming leadership in the chaos of the collapsing Reich to the quick denunciation by Hitler for treason, the Fuhrer relinquished power before his suicide to an unlikely candidate, Grand Admiral **Karl Donitz**, who for a brief period of little more than a week, was Nazi Germany's second dictator before he ordered its armed forces to surrender. The selection of Donitz by Hitler is, for our purposes here, significant, for Donitz was in an usual position to coordinate the escape of fleeing Nazis to South America and other places via the new type XXI U-boats just entering service.

But before proceeding to that story, it is worth looking at the Hitler and various other Nazi survival myths in a broad overview, in order to have a basis on which to distinguish possible fact from deliberate myth and misinformation. For these various Nazi survival myths and legends, Hitler's survival is not so much a fact, as a grotesque parody of an icon, a disturbing possibility that hovers over every version. For example, the standard view of Hitler committing suicide on April 10, 1945, is itself not without its own occult significance, for this is the date of the eve of a "witches' sabbath," the Walpurgisnacht.

Moreover, in [mediaeval Cathar doctrine](#) - a doctrine well-studied by the SS *Ahnenerbe* - suicide (the *endura*) was a permissible act, if done in concert with another, with a soul mate. Hitler and his newly married mistress of many years, Eva (Braun) Hitler, both committed suicide together.

These non-standard Hitler and Nazi survival myths run the whole spectrum, from fanciful and implausible stories of underground bases in the Canadian Arctic, or on Antarctica itself armed with some of the exotic weaponry described in the previous chapter, to more "mundane" and plausible stories of Nazi colonies in South America or secret weather stations and commando teams operating in Greenland during the war, to the well-known and best documented case, that of [Operation Paperclip](#), America's wholesale importation of Nazi scientists and doctors after World War Two to assist the United States in continued covert development and research on a whole host of black projects. In one rather interesting version of the Hitler survival myth, he and other Nazi bigwigs underwent plastic surgery before the end of the war, and were spirited off to Antarctica or South America.

One version of this myth even has an elderly Hitler ministering to the poor as a Catholic priest! is the thesis of the next two chapters that there is some truth to some of these Nazi survival myths, excluding the Hitler survival myth, and that all need to be viewed against the backdrop of the Nazis' own plans for postwar survival and continuance under a variety of fronts, organizations, or in concert with new "host" governments such as the United States or the various governments of Latin America, Africa, and the Middle East.

In this and the succeeding chapter, we will proceed by examining the more audacious survival myths, through some accounts of South American colonies, to *Paperclip*, and finally, to Bormann's top secret plan for postwar survival and economic resurgence. What will emerge from this examination is a disturbing picture that suggests deliberate Nazi misinformation in the immediate postwar period, and a deliberate attempt to disguise ongoing projects inside the black projects of the new "host" governments and corporations. A slight, though discernible connection emerges that substantiates the thesis of part one of this book, namely, that the secret weapons think tank, the Kammlerstab, survived the war more or less intact, and continued its work in a variety of host countries, most particularly in the United Kingdom and even more so in the United States, either in concert with them, and sometimes independently of them.

Then in the remaining chapters of this book, we shall examine two well-known UFO "crash and recovery" cases for the indications that they may have been the recoveries of something truly extraordinary, but not extra-terrestrial. In this examination, it is crucial to bear in mind all the information of the preceding part of this book, for they have all led up to it.

## A. The Antarctic Survival Myth

Of all the high-ranking German military leaders, Grand Admiral **Karl Donitz** is the most often overlooked, and yet he may have been the most crucial for the story of Nazi survival and continued secret weapons research. After all, the secret preparations and voyage of the U-234 to Japan, with its precious cargo of enriched uranium and infrared fuses, could not likely have taken place without his express knowledge, participation, and authorization. Thus, outside Kammler's "think tank", he was perhaps the one military leader of a conventional service arm to know the full extent of Nazi Germany's actual advances in atom bomb and other nuclear research.

Best known for his orchestration of the Nazi U-boat campaign against British, Canadian, and American shipping, his alleged role in the various survival myths is little known outside a small circle of UFOlogy and World War Two researchers. And of all the Nazi military leaders, his selection by Adolf Hitler as the second Fuhrer of the Third Reich is, at best, problematical, unless viewed in the light of these late war technology transfers and escaping Nazis. Why would Hitler have chosen Donitz, a World War One veteran of the *High Seas Fleet* of Kaiser Wilhelm, with the Kriegsmarine's well-known imperialist culture and leanings that he represented, to be his successor?

A conventional answer is afforded by the circumstances outlined above: betrayed on all sides - by Himmler and Goring themselves - a desperate Hitler reached out to what he thought was the most loyal conventional military service arm of the Wehrmacht, the Navy. But the survival mythos contributes a very different perspective from which to view Hitler's possible motivations.

Donitz himself does nothing to allay those suspicions, either during or immediately after the war. According to **Henry Stevens**, who has almost single-handedly investigated every lead - no matter how implausible the detail - of the Nazi UFO and survival legends, Donitz on more than one occasion alluded to the Navy's role in exotic secret weapons research and in the construction of very secret bases far from the Reich homeland. In 1943, the Grand Admiral is reported to have stated that,

"the German submarine fleet is proud of having built for the Fuhrer, in another part of the world, a Shangri-La on land, an impregnable fortress."<sup>2</sup>

Strange language for an admiral well-known for cold calculation in military strategy and tactics, and not well-known to be inclined to mystical statements. Then again, in 1944, the Grand Admiral doled out a little more information:

"The German Navy will have to accomplish a great task in the future. The German Navy knows all hiding places in the oceans and therefore it will be very easy to bring the Fuhrer to a safe place should the necessity arise and in which he will have the opportunity to work out his final plans."<sup>3</sup>

But it was Donitz's almost insane remarks at Nuremberg that seemed to point clearly to one of the two polar regions as the "site" for these "plans". At Nuremberg he boasted of "an invulnerable fortress, a paradise-like oasis in the middle of eternal ice."<sup>4</sup>

<sup>2</sup> Henry Stevens, *The Last Battalion and German Arctic, Antarctic, and Andean Bases* (Gorman, California: The German Research Project, 1997), p. 2, citing Col. Howard A. Buechner and Capt. Wilhelm Bernhardt, *Hitler's Ashes* (Metairie, Louisiana: Thunderbird Press Inc.), p. 1.

<sup>3</sup> *Ibid.*, p. 2, citing Buechner and Bernhardt, pp. 2-3.

<sup>4</sup> *Ibid.*, citing Willibald Mattern, *UFOs Unbekannte Flugobjekt? Letzte Geheimwaffe des Dritten Reiches?* (Toronto: Samisdat Publisher, No date), p. 38.

Whatever the trustworthiness of Steven's sources, these statements, plus the unusual behavior of some U-boats at the end of the war, and the Germans' well-publicized pre-war Antarctic scientific expedition, certainly seemed to spur the United States into a sudden and intense postwar military interest in Antarctica. Again, since the basic facts are well-known to but a small circle of World War Two and UFOlogy researchers, it is worth recalling them in some detail.

- U-530 surrendered at Mar del Plata, Argentina, on July 10, 1945
- U-977 surrendered at Mar del Plata, Argentina, on August 17, 1945
- U-465 was scuttled off the coast of Patagonia in August 1945

- Another U-boat of unknown number surrendered to the Argentine Navy on June 10, 1945 <sup>5</sup>

<sup>5</sup> Ibid., p. 48, citing Buechner, pp. 175-176.

When the U-530 and U-977 surrendered so late after the European War's end, Allied intelligence was more than a little concerned, and dispatched agents to interrogate the German officers. They certainly did not believe that the German captains had taken their ships on a South Atlantic excursion of three to four months just to surrender to the Argentines, as Captain **Schaeffer** of the U-977 and Captain **Wermoutt** of the U-530 actually, and apparently in all seriousness, stated.

Stevens summarizes the Allies' real concern - Nazi survival in no uncertain terms:

The Allies first believed that these U-Boats had taken persons of special importance, perhaps even Adolf Hitler, from Germany to South America. In light of this possibility both captains were held for questioning. Captain Schaeffer, who surrendered last, was taken to America for a month or so then to England for another period of questioning. Both captains maintained that there had been no persons of political importance deposited in South America. Eventually the captains were released although Schaeffer found living in Occupied Germany intolerable and relocated to South America. Captain Schaeffer even went on to write a book explaining his voyage and actions.

Unfortunately, nobody really believed Schaeffer. Bernhardt, who himself was aboard U-530, claims that American and British Intelligence had learned that U-530 and U-977 did visit Antarctica before landing in South America but the exact nature of their mission eluded them. <sup>6</sup>

<sup>6</sup> Ibid., p. 51, citing Buechner, p. 232.

A glimpse into this extraordinary mission and the high importance afforded by the German Navy High Command (the Oberkommando der Kriegsmarine or OKM) to it can perhaps be afforded by a glance of the alleged performance characteristics of the U-530.

In the spring of 1945, an old fashioned type U-boat with the number 530 was dry-docked after being damaged by a freighter which had rammed it. As was typical for the Kriegsmarine, a new submarine, probably a type XXI or further development of it, was launched at approximately the same time, and was given the same service number, an obvious ploy to confuse Allied military intelligence. But why was the U-boat that actually sailed to the South Atlantic and that later surrendered to Argentina probably a type XXI or some derivative?

Because Captain **Wilhelm Bernhardt**, a pen name of an actual crew member of Captain Wermoutt's U-530, let out a significant piece of information; he stated that her submerged speed was approximately 30 knots, an unheard of speed for a submerged submarine in that day. The only submarines in service in any navy in the world capable of that performance at that time were the German type XXI U-boats.

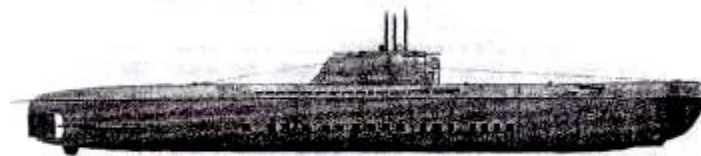

*The Type XXI U-Boat; Note the Clean Lines*

The type XXI U-boat, like most U-boats in the German Navy by that time, was fitted with the special snorkel device that allowed its main diesel engines to operate while submerged underwater. It is quite possible that these newer Type XXI U-boats also had the newer Schnorkels fitted with the special anti-radar coatings examined in the previous part of this book. But the Type XXI was also outfitted with the special "Walther" turbine, an underwater "jet" device that utilized hydrogen peroxide that allowed great underwater cruising speeds. In effect, these turbines were "silent" engines allowing great underwater speeds for limited durations of time. Thus, the Type XXI had brought submarine technology and warfare to a new and sophisticated level by the war's end. But would even the Type XXI have been able to brave the North and then South Atlantic Oceans, by that point in the war all but Allied lakes?

There is some indication that not only were they successful in doing so, but wildly so.



In the previous part of this book mention was made of special new guidance systems the Germans had adapted to missiles, and torpedoes. These systems included wire-guidance, as well as magnetic proximity fuses. Stevens reports that on May 2, 1945, a flotilla of U-boats, many of them Type XXIs, carefully husbanded by Donitz at Kristiansand fjord in Norway, departed in a wolf pack for Iceland, making the traditional run through the straits between Iceland and Greenland.

What happened next has been deleted from what passes as history, at least in the countries of the former Allied Powers. What happened was the last great sea battle of the Atlantic. The German U-boat convoy ran straight into an Allied naval battle formation.<sup>7</sup> The result was stunning. Using the new torpedoes... the Allied ships were totally annihilated. Apparently the Allies never quite realized what they had run into. Our only third-party report of the event was an article in a South American newspaper which learned of the event. A quote from the only survivor of the attack is often quoted by the underground German writers although this writer has not seen a copy of the newspaper:

"May God help me, may I never again encounter such a force" - British destroyer captain.

The British consistently maintained a flotilla of destroyers, accompanied occasionally by heavier units of light and heavy cruisers, on station in these straits throughout the war.

This was reportedly carried in "El Mercurio", Santiago, Chile, and "Der Weg" a paper published by exiled Germans living in Buenos Aires, Argentina.<sup>8</sup>

The use of new torpedoes -whether wire-guided, acoustic-seeking, or magnetic proximity-fused<sup>9</sup> - leads once again back to Karnnler's "think tank" secret weapons empire. These torpedoes, plus the high-submersible speeds and "proto-stealth" capabilities of the Type XXI U-boats would have been more than a match for the British destroyers on station between Iceland and Greenland.

But as we have previously noted, the Coler coil came to the quick attention of the Kriegsmarine in the early days of the Third Reich, which immediately classified it at the highest level, and funded further research.

It is not hard to understand the Kriegsmarine's interest in the Coler device. It is the perfect generator for submarine use. It produces no exhaust and burns no fuel. It could be linked directly to existing electric-drive vessels and run under water indefinitely. Did the Germans actually accomplish this? The underground German writers say that this indeed happened. This theme runs throughout the writing of Bergmann whose specialty is the link between German submarines and German flying saucers.<sup>10</sup>

This is an incredible, if not outlandish, claim. Yet it is worth pondering for a moment. The *Coler devices*, developed in 1933,<sup>11</sup> and their unusual ability to transduce electrical power out of something were known to the Germans fully six years before the war had even started, and were developed in secret for twelve years after that (and then presumably by the British for another twenty three years after that!). We do not know, of course, nor is the British Government saying (if indeed it knows), to what state the Germans brought this device, but whatever the state, they had fully twelve years in which to do it.

<sup>8</sup> Stevens, *op. cit.*, p. 28, citing Mattern, p. 82.

<sup>9</sup> *Ibid.*

<sup>10</sup> *Ibid.*, p. 27.

<sup>11</sup> British Intelligence Objectives Sub-Committee, 1946: *The Invention of Hans Coler Relating to an Alleged New Source of Power*, p. 2.

But whether perfected or not, notice what else is being implied by the assertion that it was brought to some state of practical use on submarines: the Germans were deliberately after a method of submarine propulsion that would have allowed indefinite submerged cruising, much as a modern nuclear submarine, but by a device much simpler in design and construction, and presumably, much less risky in operation. Whether or not the Germans were able to bring it to a state of practical use is thus, in one sense, immaterial, since the classification of the device alone indicates the nature of their interest.

In any case, the odd circumstances of the late-surrendering U-boats, not to mention the alleged naval debacle suffered by the British so late in the war when everything seemed - from a naval and military standpoint - so secure and safe, focused Allied and particularly American eyes quite quickly and forcefully on **Antarctica**.<sup>12</sup>

Whatever the Allies learned, there was a sudden, intense interest in Antarctica. This interest was so strong that in 1946, as Allied troops were returning home from the War and all thoughts were turned to peacetime pursuits, the United States Government, under President Harry Truman, found it absolutely imperative that a full military expedition be mounted against Antarctica. This campaign was called [Operation Highjump](#).<sup>13</sup>

12 It goes without saying that the high priority that the British Intelligence Objectives Sub-Committee placed on recovering a Coler device and its inventor after the war tends to corroborate the notion that the British had learned the hard way that it had been brought to some state of practical use for submarine propulsion.

13 Stevens, op. cit., p. 51.

While the operation was billed in American newspapers, magazines and even the occasional newsreel as a mapping expedition, its actual military character is easily seen from a glance at its composition. Commanded by America's premier polar explorer, [Admiral Byrd](#), the flotilla included an aircraft escort carrier (the Philippines Sea), two seaplane carriers (the Pine Island and Curritich), two destroyers (the Brownsen and Henderson), two escort ships (Yankee and Merrick), two fueling ships (Canister and Capacan), and a submarine (the Sennet). Additionally, four thousand troops equipped with helicopters, reliable fixed wing DC- 3s, and a specially designed armored tracked vehicle were also at the Admiral's command.<sup>14</sup>

Outfitted for a stay of eight months, the expedition encircled the German claimed territory of [Neuschwabenland](#) (New Schwabialand), Admiral Byrd stationing the naval vessels off the coast, and then advanced the ground troops and aerial reconnaissance from the pole toward the German territory. Allegedly the German "base" was quickly found, overflown, and either an American flag, or a bomb, depending on the version of the story, was dropped on the position. In any case, the four escort craft accompanying the scout aircraft were lost without a trace.

This single event" throws the whole *Highjump exercise* into a curious light, for,

"it somehow changed the whole character of the Byrd expedition. Within 48 hours Admiral Byrd had given orders which canceled the expedition and made preparations to leave Antarctica. The mission had lasted closer to eight weeks than to eight months. No official reason was given for the sudden withdrawal."<sup>15</sup>

**Byrd** was returned to Washington DC, debriefed, and his personal and operational logs from the mission were seized and remain classified to this day, fueling an endless stream of rumors and conspiracy theories.

But the expedition, in keeping with its cover as a mapping expedition perhaps, was composed also of small contingents of news media and reporters from other countries, one of which was Chile. A reporter working for the Chilean *El Mercurio* in Santiago, one [Lee van Atta](#), accompanied [Admiral Byrd](#), who "made some astounding statements, all dutifully recorded" and reported by van Atta, and dutifully ignored in the American press.<sup>16</sup>

In its March 5, 1947 edition, **Byrd** announced to me today that it is necessary for the United States to put into effect defensive measures against enemy airmen which come from the polar regions. The Admiral further explained that he did not have the intention to scare anyone but the hiter reality is that in case of a new war the United States would be in a position to be attacked by flyers which could fly with fantastic speed from one pole to the other.<sup>17</sup>

14 Ibid., p. 52.

15 Ibid.

16 Ibid., p. 53.

17 Ibid.



the region with little spikes to embed them in the ice, and claimed it for Germany, renaming the region **Neuschwabenland**. But they did more than just fly and drop flags.

The German pilots extensively photographed the region, and reported mountain ranges in excess of 12,000 feet altitude, rocky crags projecting above the fields of ice. But most amazingly, they allegedly found ice-free ponds, heated geothermally, in which grew various unknown species of algae. They also discovered the southern tip of the fault line that runs from New Zealand, through Neuschwabenland, and up the Atlantic Ocean, the famous Atlantic "trench". The Germans concluded that such features might indicate the presence of rocky caverns on the continent, heated geothermally, the perfect place for a hidden base in the world's most isolated, desolate, and inaccessible wilderness.<sup>22</sup>

Most intriguingly, the scientists aboard the Schwabenland were not idle in analyzing the potential foodstuffs of the continent:

Emperor penguins were captured for return to Germany for study. Walruses were shot and their bodies dissected. Their bodies were tested for fat, protein, vitamin and other nutrient content. The biological findings made during this expedition would occupy German university scientists for months to come but the aim of this focus was secret. It is known that German dieticians were commissioned to prepare tasty and nutritious meals using only what was available in Antarctica.<sup>23</sup>

Clearly, if these allegations are true, then the Germans were preparing for a relatively large and permanent presence on there continent.

<sup>22</sup> Stevens, op. cit., p. 4.

<sup>23</sup> Ibid., citing Friedrich, p. 87.

Then, via an unusual zigzagging route between Africa and South America - itself one of the intriguing mysteries of the expedition - the Schwabenland returned to Germany, reaching port on April 10, 1939.<sup>24</sup> Goering presented the expedition members with written medals and commemorations. Then, all further mention of the expedition in the German - or any other press - ceased.

<sup>24</sup> Stevens, op. cit., p. 4.

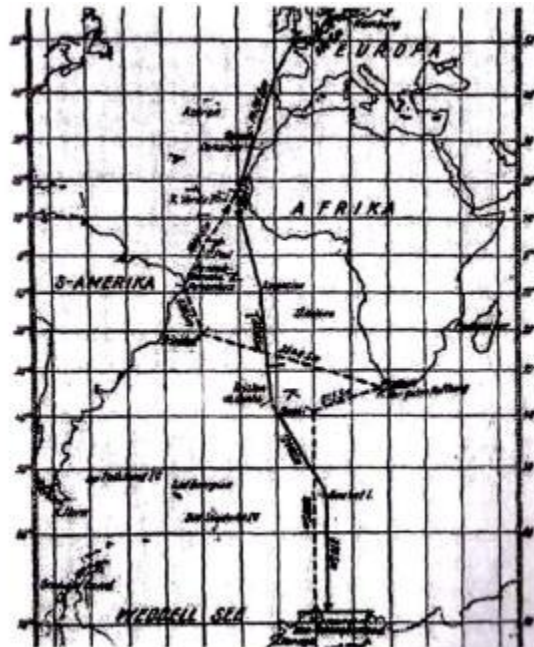

*The Outward Bound and Return Routes of the Neuschwabenland Expedition to Antarctica*



Goring's Commemorative Medal for the Antarctic Expedition

So what do we have at this juncture?

- Allegations from German writers of known or suspected Nazi sympathies of a continued German presence on the Antarctic continent during and after the war;
- Actual suspicious U-boat activity in the South Atlantic at the end of the war;
- Allegations of German research that could have been for no other purpose than establishment of a permanent German presence on the continent;
- Allegations of discoveries of small thermally heated ponds with unknown types of algae on the continent's interior;
- Allegations of Grand Admiral Donitz that the U-boat fleet was involved in the construction of a secret base or bases far from the Reich, one base of which was surrounded by "eternal ice";
- Allegations of a last sea battle in the Atlantic prior to the German surrender, with things going surprisingly disastrously for the Allies;
- An actual large postwar American military adventure to the continent within two years of the end of the war, with small accompanying international press contingents, an expedition outfitted for eight months that stayed only eight weeks; and finally,
- An actual newspaper report of Admiral Byrd trying to warn America of a military threat from "enemy aircraft" flying from pole to pole at tremendous speed.

All of this would seem to imply at a minimum that something was going on in Antarctica, and that someone in the United States Federal government was quite worried about it.

Indeed, when the United States returned to Antarctica some twelve years later, it did so once again with force, this time, nuclear force, and once again, under the cover of an "international cooperative effort," the International Geophysical Year of 1957- 1958. This means that if there were indeed Germans on a secret base somewhere on that frozen continent, they had some twelve years to do whatever they were doing. In terms of the Nazi legend, supposedly they were busily perfecting their strange wartime research.

In any case, as **Henry Stevens** points out, this period, from 1947 to 1957-58, is in fact the "golden age" of the flying saucer, encompassing the Kenneth Arnold sightings, the alleged *Roswell UFO crash* and recovery, to the famous "buzzing" of the Capital and White House by UFOs that supposedly made even the unflappable Harry Truman anxious. The famous 1952 Washington DC sightings prompted a nervous and unconvincing Pentagon press conference - the only one ever given by a general officer from the Pentagon - on the subject of **UFOs**.<sup>25</sup>

<sup>25</sup> Ibid., p. 53. Stevens further speculates on the possible motivation for the UFO overflights of sensitive areas of Washington DC: "Was this overflight in retaliation for the Byrd overflight of the German base in Antarctica and designed to show the Americans they had no control over their own airspace?" (p. 55) Stevens offers no evidence for this speculation. I will offer my own speculations concerning a similar scenario in connection with my examination of the Majic-12 documents and the Roswell incident in chapter 16. But supposing Stevens is correct for the sake of argument, then suffice it to say that overflights of the American capital by Nazi flying saucers so long after the war's end would certainly have shaken the national security

apparatus of the United States much more than overflights by apparently benign extraterrestrial ones, and the response would have been to clamp the lid down on government research of the phenomenon, exactly as happened, since the supposedly defeated enemy was not, if this is true, really defeated after all.

Under the cover of the geophysical year, the United States again sent a naval task force to the Antarctic. The use of military force -including atomic weapons! -was "covered" by the ridiculous story that the USA and USSR, in a rare moment of nuclear cooperation during the height of the Cold War, were interested in seeing how much of the continent could be "recovered" for use by warming it with nuclear explosions!

Accordingly, it would be necessary to explode a few small nuclear "devices" for above the continent to warm and melt the ice as a proof of concept!<sup>26</sup> A **Stevens** aptly quips,

"You already know exactly where in Antarctica they planned to explode these atomic bombs."<sup>27</sup>

Three bombs were thus detonated at an altitude of approximately 300 miles above the target, one on August 27, 1958, one on August 30, 1958, and a third on September 6, 1958.<sup>28</sup> If these bursts were indeed intended secretly against an actual target, then why so high? Stevens hypothesizes that they were to knock out any German equipment in the region by the strong electromagnetic pulse that results from a nuclear detonation.

While this is a plausible explanation if the intention were to occupy the alleged base via a ground assault or assaults within the time frame of the bursts, no such contingent is known to have accompanied the small armada of two destroyers, two destroyer escorts, and a small aircraft carrier.

<sup>26</sup> Ibid., p. 55.

<sup>27</sup> Ibid., p. 57.

<sup>28</sup> Ibid. Stevens also notes that these bursts may have something to do with the "ozone hole" over the South Pole and the US government's reluctance to discuss the idea or the events that may have caused it. Additionally, perhaps it is possible that one atom bomb from each of the world's then nuclear powers, the US, the USSR, and the UK, were used.

However, as we shall see in a moment, this explanation does bear some weight in connection with the allegations of the capabilities of German bases at the other pole. With the Geophysical Year expedition of 1958's atomic detonations, the alleged German base on the Antarctic continent fades, the Germans themselves supposedly gradually evacuating it during the interim period from Byrd's expedition to the final coup de grace for more favorable climes in South America.<sup>29</sup> There the case for Nazi survival and continued research becomes much stronger. But before we can turn to that, we must investigate the alleged German goings on at the other pole.

<sup>29</sup> Ibid., p. 58.

### **C. Spitzbergen, Greenland, and Arctic Canada: The Other German Polar Survival Myth**

The Western Allies, the Russians, and the Germans all relied heavily on weather reports to plan and execute their campaigns, and for this purpose, accurate up-to-the-minute reporting on Arctic conditions was crucial. To this end it is not surprising to find the Germans in particular outfitting special commando units - usually Waffen SS - to operate independently in Spitzbergen Island north of Norway, in Greenland, and in Arctic Canada.

Such teams were delivered to their operational areas via U-boat. Spitzbergen in particular seemed to trade hands between the British and the Germans, as each side mounted commando operations to destroy the other's weather stations and listening posts. On one such occasion, the most famous perhaps, the German battleship Tirpitz, sister ship to the Bismarck, sailed to the island where one such British station was operating, leveled her 15 inch heavy guns at it, and promptly dispatched it, no doubt to the complete shock and surprise of the British manning it. Other allegations have a secret German weather base and listening post operating in Franz Josef Land, the islands to the north of Finland and the Soviet Union.<sup>30</sup>

<sup>30</sup> Ibid, p. 5.

However, with the allegations of German bases in Greenland, one again enters the realm of the surreal. These bases were allegedly comparatively large, as were the contingents of Germans operating them. While they were supposedly known by the Greenlanders and occupying American forces, most efforts to find them ended in failure.<sup>31</sup> One postwar German source places as many as three independent SS battle groups (Kampfgruppen) operating in Greenland, under the

code name of *Thulekampfguppen* (Thule battle groups). The connection to the occult interests of the Third Reich are once again in evidence.

Predictably, these "Thule battle groups" become the subject of another series of survival legends, as former SS officers supposedly reported seeing U-boats loaded with rates designated "Thule 1 K" and so on departing Germany in the final days of the war.<sup>32</sup> Sworn to secrecy by the SS, the "clear implication is that the 'Thule 1 K' is the Thule Kampfgruppe 1 and that it had "no intentions of surrender; and that there was still a mission to accomplish."<sup>33</sup> The Americans, so the story goes, were unsuccessful in locating them bases for two reasons: the area was too large, and the bases were "like the German fortifications built in Neuschwabenland... tunneled deep underneath the glaciers of ice (into presumably solid rock) and that they were bored to a length of 2000 meters."<sup>34</sup>

This allegation is surely implausible, since the transport of sophisticated mining and boring equipment, let alone enough explosive, for such a task by U-boat would have been an enormous undertaking, one quite beyond the labor capabilities of small SS battle groups.<sup>35</sup>

31 Ibid., p. 6.

32 Ibid., p. 8.

33 Ibid.

34 Ibid., citing O. Bergmann, *Deutsche Flugscheiben und U-Boote Überwachen die Weltmeere*, Hugin Gesellschaft für politisch-philosophische Studien (Horstl, Germany: 1989), pp. 134, 137.

35 Consider the fact that the huge underground factories in Germany were built over several months by thousands of slave laborers working around the clock with the best available existing mining and tunneling technology.

But this is not the end of the surreal aspects of the story. Should the bases have been detected, they were supposedly defended with exotic electromagnetic weapons, one of which had a short range, but that could cause the ignition of aircraft engines to fail completely.

After the war, the Vienna *Wiener Montag* reported in its December 29, 1947 edition that Eskimos reported to American authorities that an SS battle group of fully 150 men had been encountered.<sup>36</sup> Besides these allegations of large bases and battle groups and exotic weaponry, there is a similar account circulated by the distinctly pro-Nazi novelist Wilhelm Landig in his 1971 novel *Gotzen gegen Thule*, a novel he billed as "full of realities" (voller Wirklichkeiten), of a large German base in the Canadian Arctic, near the magnetic North pole.

This base, he alleges, was serviced by the German military using special long-range aircraft and, of course, flying saucers! As if that were not enough, **Landig** maintains that these aircraft were not equipped with normal machine guns or cannon for their defensive weaponry, but utilized a Metallstrahl, essentially an electromagnetic "rail gun" used to propel tiny pellets with extreme velocity, a kind of hyper-velocity shotgun that would more than rip apart any Allied aircraft, and do so at great distances.<sup>37</sup>

All of these allegations would remain merely fanciful if it were not for the discovery by American UFOlogist **William Lyne** - himself definitely outside the "mainstream" of the UFOlogy community - of a piece of German equipment that, quite literally, he bought at a second-hand store in White Sands, New Mexico!<sup>38</sup> The unusual thing about this piece of equipment was not only its circular central swastika - a clear reference to the occult *Thulegesellschaft* since that version of the swastika appeared on its emblem - but also its designation as a *Peiltochterkompass*, a "daughter compass."

36 Ibid. Again, the number 150 is realistic for a battle group, but quite below the labor requirements for the construction of such large bases.

37 Ibid., pp. 11-12.

38 Lyne is the author of a rather extraordinary book of UFOlogy - a field in which the extraordinary seems to be the norm - called *Space Aliens from the Pentagon*, the main theme of which is his adamant insistence that UFOs are entirely terrestrial and man-made, and being used to advance a fictitious "alien agenda" and psychological operations campaign. Lyne, notwithstanding the more often than not unbelievable aspects of his book, was, in addition to Stevens, one of the few UFOlogists to take the Nazi origins myth of UFOs seriously prior to the publication of Nick Cook's *The Hunt for Zero Point*.

Investigating this strange piece of equipment further, Lyne concluded that it was no ordinary compass, since it appeared not to operate by any magnetic means, which might explain how it ended up in White Sands, New Mexico! Lyne and his mysterious compass even became the subject of an article in a local American newspaper.

Why is Lyne's find so important to the allegations of Nazi bases in the Canadian Arctic that were being supplied by long range aircraft?

Very simple.

If there were ever any truth to the allegations of German bases in these heavily forested regions, then normal magnetic compasses would be of virtually no use for navigation purposes in the region, since standard compasses are notoriously inaccurate at the polar regions with solar energy cascading down and causing local disruptions of the magnetic field. Some other method, therefore, had to be found to orient aircraft for safe navigation. **Landig** alleges that this was done by means of a compass that oriented itself to the sun by reading polarized light, rather than magnetic field lines.<sup>39</sup> **Lyne** therefore seems to have found some version of this compass in an area of America known for its secret research laboratories some twenty years or so after Landig's surreal allegations first appeared!

But according to Landig there is even more to consider, for according to him the German base in the Canadian Arctic was actively researching and developing so-called "free energy" devices, devices that would tap the so-called "zero point energy" of quantum mechanics. In this connection, the research was allegedly carried out under the auspices of the SS Entwicklungstelle IV, or SS "Developmental Installation IV," an entity, if it existed at all, that would have fallen under the mission brief and jurisdiction of Kammler's SS Sonderkommando, for it was responsible for "research into making Germany independent of foreign energy sources."<sup>40</sup>

39 Stevens, op. cit., p. 12.

40 Ibid., p. 19.

## There are no UFOs, just U.S. secrets

Las Vegas resident says stories about "space aliens" are propaganda to cover up a giant government conspiracy.

BY TOM BRADSHAW  
COLUMNIAL STAFF WRITER

Bill Lyne says stories about space aliens and UFOs are part of an elaborate government conspiracy to keep secret the existence of man-made electrical flying machines.

"I can't tell them in the city during any night, usually after sunset. I've seen them here in Nevada."

Lyne said many people mistake these machines for stars, but that he has learned how to distinguish between the two.

Lyne's flying machines "blink and vibrate like stars," he said. "Sometimes they blink with regularity, so much that they give you a headache."

Now they have entered Lyne's neighborhood in some local stores.

"Secret aliens from the 'Nazis' with Lyne's hand-painted signs which appear as brilliant silver stars in a bright blue magnetic energy vortex and continue, it is said to spin.

The 200-page book aims to set the record straight, at least from Lyne's point of view, about how "Nazis" are "the Jews of New Mexico," who the northern part of the state has become a "base of the primary distribution and distribution points for 'Man-made' oceanic traffic" and how the government often were "secret headquarters" for spies.

Lyne's most compelling theory is that the Nazis had been discovered by a man-informant campaign to have UFOs, and the machines and other odd occurrences are extraterrestrial.

The real story, he says, goes back to a Nazi scientist named (Heinrich) Heise who discovered the missing magnetic



Bill Lyne (center) what he says is a part from the guidance system for a German World War II "flying saucer."

See "Nazi" on PAGE 3

### January 6, 1994 Albuquerque Journal North Article Featuring William Lyne and His Mysterious Nazi Compass

So with Landig's fantastic allegations, we come full circle back to the exotic energy sources, the technologies, the occult, and the SS research being conducted by Nazi Germany. Therefore, before proceeding to examine more seriously substantiated instances of Nazi survival in the next chapter, it would be worthwhile to summarize the accumulated allegations and evidences of this and previous chapters:

- (1) Fact: The Germans undertook an expedition to Antarctica whose hidden purpose was clearly military in nature, since one cannot imagine the likes of Reichsmarschall Goring sponsoring an expedition for any other purpose;
- (2) Fact: The United States on two separate occasions over the wide time-frame of eleven to twelve years undertook two large military expeditions to that continent, both under appropriate cover stories for mapping (the 1947 Byrd expedition, Operation Highjump), and for the 1957-58 Geophysical Years (to study the effects of atomic blasts on Antarctic weather!);
- (3) Fact: Admiral Byrd, the leader of the first American expedition, was recorded in a South American newspaper as warning of "enemy" aircraft capable of violating American airspace with ease, and of flying from pole to pole with tremendous speed;



(4) Fact: The German Navy showed great interest in the "free-energy" ideas and coils of Hans Coler, for the ostensible purpose of creating a means of submarine propulsion that would allow German U-boats to stay submerged more or less indefinitely;

(5) Fact: Admiral Byrd's diaries and logs from his expedition are still classified;

(6) Fact: Coler's inventions were highly classified by the German Navy, and later by the British, who only declassified them over thirty years after the war's end;

(7) Fact: The Germans had also apparently contrived a sophisticated compass for possible use in polar regions by aircraft, and possibly by other less conventional aircraft;

( 8 ) Fact: the alleged time span of the German Antarctic base's survival is coincident with "golden age" of the UFO, from the Arnold sightings, the Roswell crash, up to and beyond the great 1950s Washington DC UFO flap;

(9) Fact: SS General Dr. Ing. Hans Kammler had assumed total control of all the Third Reich's secret weapons research by the end of the war, a position which would have made him privy to the German Navy's research;

(10) Fact: It is evident from the movements of General Patton's divisions in the closing days of the European war that Kammler's SS secret weapons empire was the deliberate, and principal, target of these military operations;

(11) Allegation: Grand Admiral Donitz on more than one occasion alluded to the role of the German U-boat fleet in the construction of secret bases in polar regions;

(12) Allegation: These bases were staffed by SS troops, and presumably technicians conducting ongoing secret research into "zero point energy" or "free energy";

(13) Allegation: Said research fell under an SS entity called S- IV, recalling Kammler's S-III mentioned briefly in part one;

(14) Allegation: These bases were said to be defended by exotic types of weaponry, including electromagnetic "rail guns" to devices that could interfere with and halt standard electrical engine ignitions systems;

(15) Allegation (from part one): There were secret SS teams working on "areas of physics" even more exotic than atomic and thermonuclear energy;

(16) Allegation: There is a connection to Nazi occult interests in the polar regions via the myth of "Thule", the pre-war occult Thule Society (Thulegesellschaft);

(17) Fact: The highest levels of the SS were initiates into Himmler's occult inner circle at Wewelsburg, making it likely that Kammler himself was such an initiate;

(18) Fact: The 1944 German atom bomb test at Rugen island took place at a location with its own occult pedigree and significance for the pre-war Germanic, and very occult, Order of the New Templars.

What emerges from this list is disturbing indeed. Clearly, a prima facie case can be made that the Nazi leadership had invested significant resources in the investigation of any and all avenues to power, occult and otherwise, and to new sources of energy. And equally clearly, the Nazi leadership was willing to think "outside the box" and to go to any lengths - often quite literally - to research those matters. What also emerges from this list is a preoccupation with areas of physics, and areas of the globe, almost completely neglected - at least publicly - by the wartime Allies.

Moreover, what also emerges is a disturbing sense, that maybe, just maybe, there was something to the survival myths after all, for one thing seems clear from the pattern of events after the war, particularly in respect to Antarctica: such myths were inevitably connected to the exotic research pursuits the Germans were conducting, and such myths seem clearly to have been the hidden motivation for American counter-strikes.

[Back to Contents](#)

## Chapter 15: THE PHOENIX RISES: THE BORMANN PLAN

"The documents I had before me... contained firsthand evidence that the Reichsleiter had survived the war and succeeded in escaping to Argentina. It was attested by the Argentine authorities themselves, in highly classified intelligence reports and positions papers drawn up for their own secret and official use."

### Ladislav Farago

Aftermath <sup>1</sup>

<sup>1</sup> Ladislav Farago, *Aftermath; Martin Bormann and the Fourth Reich* (New York: Simon and Schuster, 1974), p. 60.

As the war turned irrevocably against the Third Reich, top Nazi leaders began to plan for the future, among them the Nazi Party's Reichsleiter Martin Bormann, Adolf Hitler's secretary and virtual shadow, and financial administrator of the Party's, as well as of Hitler's own personal and considerable, fortune. While much of this story is known to the general public in broad outline, few appreciate the degree of organization, planning, and success it had, and, unfortunately, may be continuing to have.

Even fewer appreciate its significance, for what began in the secret societies of post-World War One Germany as the most explosive political movement in modern history would end by once again going underground, and operating behind a variety of false fronts that included corporations, black projects, secret societies, and criminal and paramilitary syndicates. It would thus exercise a considerable, though hidden, moral and cultural influence on the world that emerged after World War Two.

With the failure of the final large German offensive in Soviet Russia at Kursk in 1943, the Nazi leadership had but two courses of action:

(1) continue the war and hope for the realization of their secret weapons projects in time to provide a military resuscitation, or

(2) begin the process of moving capital, technology, and personnel to ensure the survival of the Party by other means. The Nazi leadership chose both courses of action.

At first the movement of resources abroad - monetary, technological, and human - proceeded haphazardly. Money and loot from a plundered Europe made its way into secret Swiss bank accounts, or in the case of hard assets - precious minerals, bullion, art, diamonds and other gemstones and so on - made its way overland through France into "neutral" but decidedly pro-Axis Nationalist Spain.

But it soon became apparent that haphazard efforts would not ensure the survival of the Party, nor the furtherance of its ideals, nor the spread of its power in the postwar world, nor the continuance of its research projects, which would have to be continued if it ever hoped to regain power and influence. Organization and long-range planning in depth and breadth had to occur if Nazism were to survive covertly. To this end, Reichsleiter **Martin Bormann** orchestrated a top secret meeting on August 10, 1944, at the Hotel Rotes Haus in Strassburg, in occupied France.

Representatives of all the major German industrial and armaments firms were present, including the huge firms of Krupp, Thyssen, and of course, I.G. Farben. Also present were **Bormann** himself, **Hjalmar Schacht**, president of the Reichsbank, and his son-in-law, the famous SS commando, Colonel **Otto Skorzeny**, leader of the daring air mission to rescue Benito Mussolini in 1943.

At this meeting,

"provisions were made not only to move great sums of money outside Germany but also to camouflage foreign assets on paper for the resurrection of a financial-industrial empire, of sorts, once the Reich collapsed. This empire was to be controlled by the SS."<sup>2</sup>

<sup>2</sup> Henry Stevens, *The Last Battalion and German Arctic, Antarctic, and Andean Bases*, p. 58.

As a result of this plan, the well-known SS-run ratlines were formed to assist fleeing SS and other Nazis, to provide for their financial security, relocation, and false identities. The most famous of these was of course the ODESSA group, or the *Organization Der Ehemahlige SS Angehörige*, or "*Organization of Former SS Members*." Another famous organization was "*Die Spinne*" or The Spider. In any case, under the Riechleiter's powerful protection, the SS, in concert with the Kriegsmarine, began to smuggle enormous quantities of gold, precious gems, art and both genuine and counterfeit cash out of Germany. To a lesser extent, machine tools, steel, technicians and other personnel began to be quietly siphoned off Germany industry and smuggled out of Europe.<sup>3</sup>

The financial treasure trove was then laundered by the SS via a variety of methods, for example, through Evita Peron's Swiss bank accounts, through dummy corporations, through the South American drug trade, and so on.<sup>4</sup> During this immediate postwar period, most of this fortune was controlled by Otto Skorzeny.

The German industrialists who had been set up abroad with SS money dating back to the deal at the Rotes Haus in Strassbourg in 1944 were asked by Skorzeny to pay back their loans. Both Thyssen and Krupp did so, as presumably did others. To give the reader an idea of the sums collected by Skorzeny, Eva Peron alone had an estimated \$800 million dollars in bank deposits, in 1945, and 4,600 carats of diamonds and other precious stones, 90 kilograms of platinum and 2,500 kilograms of gold.<sup>5</sup>

With these *monies*, the SS purchased huge tracts of land in South America and elsewhere, and large corporations were established in which "research which (sic) had begun in Germany could be carried through."<sup>6</sup> These "secure areas" or Sperrgebiete often saw the establishment of whole towns, airfields, highways and all the amenities of civilized German life.<sup>7</sup>

Local security was, of course, provided by the SS or "contract labor" from the host country. The most famous of these colonies, perhaps, is the *Colonia Dignidad* in Chile, a "colony" notorious for the disappearances of the too-inquisitive reporter, and implicated in the US overthrow of the Chilean Marxist government of Salvador Allende in the early 1970s and the training of Chilean dictator Pinochet's DINA "interrogators."<sup>8</sup>

<sup>3</sup> Stevens, *op. cit.*, p. 59.

<sup>4</sup> *Ibid.*, p. 62.

<sup>5</sup> *Ibid.*

<sup>6</sup> *Ibid.*, p. 63.

<sup>7</sup> *Ibid.*, pp. 63-64.

<sup>8</sup> Q.v. Peter Levenda, *Unholy Alliance: A History of Nazi Involvement with the Occult* (New York: Avon Books, 1995), pp. 300-301, 343-356.

And of course, these secure areas in the Andes and other remote South American locations are also reputed to be the sites of secret Nazi laboratories continuing the research on "flying saucers" and other wartime Nazi black projects.<sup>9</sup>

<sup>9</sup> Stevens, *The Last Battalion*, p. 64.

Whatever one may think of the truthfulness of the last allegation, it is true - and generally well known - that such colonies of Nazis did and still do exist in South America, with connections to the South American underworld and governments that one can only imagine. But there is good reason not to dismiss even the "continued research" allegation too quickly, for it conforms to a well-known pattern of secret post-war West German corporate and military research on the continent on the other side of the Atlantic Ocean, Africa.

In the final months of his administration, President Jimmy Carter accused South Africa's apartheid government of having tested an atom bomb in the Indian Ocean. German and American newspaper reporters quickly uncovered - in spite of Praetoria's denials - a tapestry of corporations and dummy corporations that clearly led back to West Germany's Bundeswehr, and to a multitude of personnel and military officers with ties to the Third Reich. The goal was clear: The Federal Republic was supplying massive technological assistance to South Africa (and to Israel as it turned out) in the areas of uranium enrichment and plutonium transmutation via centrifuges and other processes, in return for which uranium-rich South Africa bartered the raw atomic fuel itself.

Germany could thus fulfill its postwar treaty obligations by not developing or deploying atomic, biological, or chemical weapons on German soil, while at the same time using South Africa to construct and test a bomb of essentially German design. If this sounds familiar, it is, for after World War One, Germany side-stepped the Versailles treaty - which forbade the Germans possession of tanks, aircraft, and heavy artillery beyond a certain caliber - by concluding a secret protocol in the Rapallo treaty with the other pariah of the day, the Soviet Union.

Thus, as early as 1922, German officers were training in tank warfare in the Soviet Union with their Russian counterparts, among them the future Colonel-General **Guderian** who would lead the Second Panzer Army during *Operation Barbarossa* to the very gates of Moscow.<sup>10</sup> In yet another important study challenging the standard assumptions of the origin and transmission vector of the human AIDS virus and the history of the discovery of HIV, Dr. **Leonard G. Horowitz** makes a solid case for its genesis within secret American biological warfare research at Fort Detrick, Maryland.

But there is more to Horowitz's investigations than this, for there is a German connection lurking deep in the background, and once again, it goes back to Bormann and presages the 1944 Rotes Haus meeting in Strasbourg:

In the Spring of 1944, Merck and Company, Inc. received a large cash infusion from Martin Bormann.... This at the time Merck's president, George W. Merck, was advising President Roosevelt, and initiating strategies, as America's biological weapons industry director. According to CBS News correspondent Paul Manning, the lion's share of the Nazi gold went to 750 corporations, largely including Merck, to secure a virtual monopoly over the world's chemical and pharmaceutical industries. This was done not only for Germany's economic recovery, but to assure the rise of "The Fourth Reich."

**Merck**, then, along with Rockefeller partner I.G. Farben, received huge sums of money from the Nazi war chest to actualize Hitler's proclaimed 'vision of a thousand-year Third Reich (and) world empire. This was outlined with clarity in a document called 'Neuordnung,' or 'New Order,' that was accompanied by a letter of transmittal to the (Bormann led) Ministry of Economics.

'Bury your treasure,' Hitler advised Bormann, 'for you will need it to begin a Fourth Reich.'<sup>11</sup>

<sup>10</sup> The often overlooked story of the West German bomb and its very secret development was covered in the New York Times book by Zdenek Cervenka and Barbara Rogers, *The Nuclear Axis: the Secret Collaboration Between West Germany and South Africa*, (New York Times, 1978), ISBN 0-8129-0760-4

<sup>11</sup> Leonard Horowitz, D.M.D., M.A., M.P.H., *Emerging Viruses: AIDS and Ebola: Nature, Accident, or Intentional?* (Sandpoint, Idaho: tetrahedron, Inc., 1999), p. 335.

**Bormann** apparently ignored his Fuhrer, and in a momentary burst of *Christianity*, heeded *Christ* by not burying his treasure, but investing and increasing it.

In any case, as late as 1988, as the Soviet Union was nearing its collapse, Russian premier Mikhail Gorbachev appeared to be trying to point a finger of blame for the AIDS epidemic in Africa in Germany's direction. Via Russian diplomatic channels and contacts in the former Belgian Congo, now Zaire, the Russian government had learned of a Zairean physician who had formerly worked for the West German OTRAG corporation, or *Orbital Transport and Missiles, AG*. This doctor's OTRAG laboratory had been tasked with isolating viruses from the African green monkey that were capable of such rapid reproduction that it could destabilize the human immune system. The laboratory's assignment was to develop a mutant strain "that would be a human killer," since the green monkey variety was harmless to humans.<sup>12</sup>

But it is really the OTRAG establishment in Zaire that is itself of the greatest interest, for it fits the pattern of postwar SS relationships with South American governments and false front corporations. OTRAG was granted a lease by the Mobutu government to 29,000 square miles of Zaire, a lease that gave OTRAG "complete sovereignty and control over the area."<sup>13</sup> What was the purpose of this land? Ostensibly, it was to develop and test there cheap satellite launch capability for private industry, an application with obvious military overtones.<sup>14</sup>

In other words, what one has with the OTRAG-Zaire enclave is something like an Area 51, but owned by a private corporation. The enclave is nothing less than a testing facility for missiles and laboratories for biological, and presumably other types of weapons development. According to the German Information Service of South Africa, OTRAG executives included former Nazis, some from the wartime V2 rocket project.<sup>15</sup>

<sup>12</sup> Horowitz, *Emerging Viruses*, p. 364.

<sup>13</sup> *Ibid.*, p. 365.

<sup>14</sup> *Ibid.*, pp. 365-366.

<sup>15</sup> *Ibid.*, p. 366.

This in itself should give one pause, for it indicates that German rocket research was continued, not just by former Nazis working for **Von Braun's NASA** in the USA, or building massive boosters for **Korolev** in the Soviet Union, but also for West Germany itself! Moreover, OTRAG's shares were subsidized by the West German government, Chancellor Helmut Schmidt's denials notwithstanding.<sup>16</sup>

Finally, in what is a clear indication that **OTRAG's** purpose and goals were not simply to contrive cheap satellite launch capability, Penthouse magazine ran an expose of the German company, disclosing its ties to the Dornier and Messerschmitt-Belkow-Blohm aerospace and armaments firms which were quietly developing and testing German cruise missiles on OTRAG's Zaire range, with the aid of cruise missile technology provided to them by the American Boeing Corporation.<sup>17</sup> Dornier and Messerschmitt were, of course, clearly tied to the Third Reich's war machine and had deep ties to its black projects.

16 Ibid.

17 Ibid, p. 367.

## A. Bormann 's Special Evacuation Command and the Link to the Kammlerstab

In part one we noted that **Carter Hydrick** theorized that it was none other than Martin Bormann who arranged the surrender of the U-234 and its precious cargo of enriched uranium, infrared proximity fuses, heavy water, and possibly even atom bomb designs or an actual functioning atom bomb to the United States.<sup>18</sup> Recent research by **Nick Cook** would tend to corroborate Bormann's role in, and therefore probable accurate knowledge of, the full scope and extent of Kammler's secret black projects empire.

18 It should be noted that Hydrick does not maintain that the Nazis were successful in building and successfully testing an atom bomb during the war, much less of trying to transport blueprints or a functioning model to the Japanese in the U-234. I maintain this possibility on the basis of the research presented in part one, and on the corroborative evidence presented by Robert Wilcox in his *Japan's Secret War*, that the Japanese successfully tested a bomb shortly after the bombing of Nagasaki. An infusion of actual bomb designs to the Japanese by the Germans late in the war might account for their relatively quick ability to develop and test a weapon under such difficult circumstances as the Japanese economy and military were in at the end of the war. However, it should also be noted that the Japanese had independently designed their own workable bomb along similar lines as existing German designs, as well as along the lines employed in the Little Boy Hiroshima bomb.

Bormann's position as controller of Nazi Party finances as well as of Hitler 's estate would have given him control over yet another source of funding for these projects, a source completely independent of the state.

It is in this total context both of Carter Hydride's meticulous research, as well as of Bormann's own Rotes Haus plan for Nazi survival, that we may place Bormann's 1945 establishment of a special SS evacuation Kommando, an act that placed jurisdiction over the Ju 290 four engine and Ju 390 six engine heavy-lift ultra long range air transport of Luftwaffe Kampfgeschwader 200 under the direct control of none other than SS General **Hans Kammler**.

The intention is clear: as much of the actual research files and equipment of the Kammlerstab as could be evacuated from Germany for destinations unknown was to be handled by Kammler personally. This special evacuation command held these aircraft in readiness near Lower Silesia in late 1945. By this point, Kammler's power, backed by the Reichsleiter himself, was so great that he could refuse a request by Reichsfuhrer SS Himmler for the use of one of these aircraft.<sup>19</sup>

Kammler, "with such aircraft at his disposal" would have been able to fly a large cargo of "documents, personnel and technology pretty much anywhere" that he wanted to. "Spain, South America - Argentina even -would have represented no problem to such a long-range platform."<sup>20</sup> Cook himself quips, "What was the point of chasing Kammler, if he'd already shipped everything out?"<sup>21</sup>

19 Nick Cook, *the Hunt for Zero Point*, pp. 186-187, 199.

20 Ibid., p. 199.

21 Ibid.

This revelation, coming late in the story of research into Nazi secret weapons and the Nazi UFO legend, gives a clear indication that more than just money, bullion, gems, art treasures or personnel were involved in Bormann's survival plan. Clearly, Bormann meant to preserve and continue the research already under way in the Reich by transplanting the technology and continuing its development elsewhere, either under independent Nazi control - as the various "survival" myths maintain - or under the nominal control of a host government, or via some combination of both modalities.

If **Carter Hydrick** is correct that it was Bormann's intention to surrender the bulk of this technology to the United States - and I believe he is - then this puts Himmler's last ditch and clumsy efforts to negotiate a separate peace with the Western Allies via Sweden into a new light. As has already been suggested in this work, Himmler was perhaps offering them the vast cache of secrets he thought he controlled through Kammler's "think tank."

And, as has been seen, it is very possible that the American intelligence community already knew of this treasure trove via their SS contacts through Allen Dulles and SS General Wolff, and had made "other arrangements" that included neither Himmler nor the British. Thus, by the time of Kammler's refusal to his SS boss to allow him the use of a Ju 290 or Ju 390, effective control and disposition of the SS black projects had slipped from Himmler's hands and into Bormann's. Himmler could neither surrender nor even barter for his life, because he had nothing left with which to bargain. Kammler, and Bormann, however, had a great deal to offer the Americans in exchange for their lives.

## B. Paperclip, Compartmentalization, and Capitalization

According to **Nick Cook**, [Operation Paperclip](#), the covert project to bring former Nazi scientists and engineers to the United States to work on America's own aerospace and military black projects after the war, was the primary beneficiary of the Kammlerstab's think tank secrets, blueprints, and patents.

"The state within a state had been transported four thousand miles to the west and somehow, I just knew, Kammler had come with it. The intuitive feeling I'd experienced in all these years in obscure corners of the US aerospace and defence industry had suddenly acquired a face."<sup>22</sup>

<sup>22</sup> Nick Cook, *The Hunt for Zero Point*, p. 252.

But an important question remains to be answered here. Could these Nazis have continued their lines of research quasi-independently, even while ostensibly working for the US military? Could they have again reconstituted themselves as a similar "state within a state," a black projects coordination office within the structures otherwise nominally under the control, of the American government and military?

Clearly, it would be difficult, especially if there were no means of independent financing of these projects, altogether apart from the US government's own "black budget." But we have already seen that a crucial component of Bormann's postwar survival and resuscitation plan was capitalization. Three conduits in particular were often utilized by O.D.E.S.S.A and other postwar Nazi secret organizations:

(1) drugs and thereby organized crime,

(2) the Church, i.e., various "ministries" within Protestantism and diverse religious orders and congregations within the Roman Catholic Church, and

(3) false corporate fronts and dummy corporations, holding companies, and banking institutions.

The United State, particularly in the last few decades, seems to have been a fertile ground for all three types of activity, at least in general terms.

As for maintaining the secrecy of such an independent and "occulted" entity, this is a solved problem, for the Manhattan Project was just such an entity, with only a very few at the highest echelons of its myriad compartmentalized "need-to-know" departments possessing the whole picture. In the postwar atmosphere, particularly with the Cold War ensuing, it may actually have been quite easy to accomplish. With US government defense contracts and black projects run increasingly on a cost-plus basis, all expenses for such research was funded, with an addition margin tacked on for corporate profit. This, added to the other genuinely off-the-books funding that Bormann and the SS envisioned, would have supplied twin sources of funding of almost limitless wealth.

But the most important consideration with respect to this question is the fact that the very classification and compartmentalization of black projects would itself operate as a favorable environment to run an "unofficial" black project within an "official" one. With projects split over several locations, its needed technologies farmed out to various companies, various departments of government, and coordinated from some secret center, it would seem a relatively easy, rather than difficult, thing to do.

The Nazi Party had been constituted, from its early secret society beginnings, and up until the very day of the German capitulation, as a state within a state. Within that structure, Himmler had constituted the SS as a state within the state within the state. And within that **Kammler** had assembled and coordinated a vast machinery of horror and weapons

research that lived, parasitically, on the body of its host, the SS and the Party, themselves murderous parasites living off the misery of Germany and Europe.

Kammner had done it once, and may very well have done it again, "with a little help from his friends." As was mentioned previously, perhaps President **Dwight Eisenhower**, when he warned of the morally and spiritually corrupting dangers of the military-industrial complex, had in mind a phenomenon that was not so much home-grown, as much as one that had been transplanted.

[Back to Contents](#)

## Chapter 16 ROSWELL

### THE "E.T. MYTH" VS. THE "NAZI LEGEND": AN EXAMINATION OF SOME MJ-12 DOCUMENTS

"Worse, the fact that this craft and other flying saucers had been surveilling our defensive installations and even seemed to to evidence a technology we'd seen evidenced by the Nazis caused the military to assume these flying saucers had hostile intentions and might have even interfered in human events during the war."

"At the very least, Twining had suggested, the crescent-shaped craft looked so uncomfortably like the German Horten wings our flyers had seen at the end of the war that he had to suspect the Germans had bumped into something we didn't know about. And his conversations with Wernher von Braun and Willy Ley at Alamogordo in the days after the crash confirmed this. They didn't want to be thought of as verruckt but intimated that there was a deeper story about what the Germans had engineered. "

**Col. Philip J. Corso**, (Ret.),  
[The Day After Roswell](#) <sup>1</sup>

<sup>1</sup> Col. Philip J. Corso, (Ret.) with William J. Birnes, [The Day After Roswell](#) (New York: Pocket Books, 1997), pp. 4, 73.

### A. Introductory Remarks

In these final chapters I propose to offer a different interpretation of two famous UFO "crash and recovery" cases than is the standard in the UFOlogy community, as a speculative corroboration of the thesis that somewhere, someone was continuing the line of very secret black projects the Nazis had initiated. The two famous cases are the 1947 Roswell crash, and the 1965 Kecksburg, Pennsylvania crash. These speculative reinterpretations of these two events are impelled, in part, by the momentum of the evidence thus far presented, and in part by the two remarkable statements made by Colonel in his well-known book, [The Day After Roswell](#).

Indeed, these statements of **Corso**, coming as they do in a book whose main thesis is the seeding of recovered "alien" (i.e., extraterrestrial, and not "foreign") technology into American industry, are for that very reason all the more remarkable, and they seem to invite such a reinterpretation. But what exactly is the ET myth of the UFO? To examine it, one must place it within the multitude of hypotheses that attempt to explain the genuine UFO phenomenon:

- (1) The phenomenon represents a spiritual deception by demons of the human race;
- (2) The phenomenon represents a life form from higher dimensions, or perhaps a life form composed directly of electromagnetic energy or even plasmas;<sup>2</sup>
- (3) The phenomenon represents intelligently controlled real physical spacecraft from other planets, usually with the tacit understanding that these are the craft from planets of other solar systems, and that the craft have thus traveled a minimum of four light years to visit earth, since the closest neighboring star is four light years away;
- (4) The phenomenon is terrestrial and human in origin (usually with the added condition that they are government black projects back-engineered from captured or crashed extraterrestrial craft, and sometimes in conjunction with the hypothesis that the "visitors" are humans from our own future).

It is a generally established fact that the bulk of UFO sightings that are considered genuine are usually interpreted in UFOlogy by the fourth hypothesis, with numbers two and three following not far behind. This is particularly the case with the Roswell and Kecksburg crashes.

The well-known quantum and plasma physicist **David Bohm**, for example, came to the conclusion that some of the plasmas with which he experimented in his early career exhibited the sort of self-organizing properties that one normally ascribes to life. Bohm ended his plasma experiments at that point.

It is consequently fair to say that an "ET Myth" or perhaps better, an "ET paradigm" has grown around the phenomenon to such an extent that any serious study or contemplation of the possibility of a terrestrial human origin and explanation for these events is seldom considered seriously. And the US Air Force's own ridiculous explanations of Roswell - from weather balloons, crashed Japanese bamboo balloon-bombs, and *Project Mogul* balloons designed to monitor Soviet nuclear tests (which in any case were not to begin until two years later) - have only added fuel to the ET Myth as the regnant paradigm by which to interpret these two signal events.

By designating this interpretative framework by the term "ET Myth" I do not, however, wish to imply that there is no basis in solid research or rational conjecture for it. I use the term "myth" here not in the contemporary sense of implying something "unreal" but in its classic sense as an all-encompassing paradigm by which an unusual phenomenon, in this case flying saucers, tends to be interpreted even by the best, most objective, and scrupulous researchers.<sup>3</sup>

**3** I would certainly include UFOlogists such as Don Berliner, Stanton Friedman, Timothy Good, and Nick Pope in this category.

Yet there is another "myth" of the flying saucer phenomenon, the one that we have been examining in the past few chapters of this book. And once one admits into the discussion a possible terrestrial origin and explanation for the phenomenon, one will inevitably have to deal with this other myth and its historical origins in World War Two.

## B. The Similarity of Evidence for Roswell and the "Nazi Legend"

As noted at various points throughout this book, the "Legend" of a Nazi origin of many wartime and postwar UFO reports received a big "credibility boost" when a researcher and reporter for the prestigious *Jane's Defense Weekly*, British reporter **Nick Cook**, wrote a book on anti-gravity and quantum zero point energy research called *The Hunt for Zero Point*. The "credibility boost" that Cook's book gave to this Nazi Legend might even be seen as analogous to the "credibility boost" that Colonel Corso's book gave to the Roswell crash and the ET interpretation of it.

Cook's book, like Corso's in some respects, is a personal chronicle, summarizing in anecdotal fashion his own personal research into American anti-gravity projects - a "hunt" as he calls it-that quickly led him to a very unsuspected source: Nazi Germany. Recounting how many of the best reports of "foo fighters" or UFOs during the war were submitted by the 415th Night Fighter Squadron, and occurred in a triangle over southern Germany from Frankfurt-am-Main, Metz, and Strasbourg in the year 1944.

Cook then recounts his discovery of the book that gave birth to *the Legend*, German Major **Rudolf Lusar's** *German Secret Weapons* of World War Two:

Seeking clues to the foo-fighter mystery, I discovered a copy in the reading room of the Imperial War Museum. In it, Lusar described in meticulous detail, in language that often made the depths of his bitterness clear, the technical achievements of 'a small, industrious and honest nation which lost the war.'

Secret Weapons made somber reading. Although German technical achievements were visible in developments such as the V-1 flying bomb, a direct forerunner of the modern-day cruise missile, and the V-2 ballistic missile, it was the vast extent of Germany's underpinning technology base, as revealed by Lusar, which showed just how far ahead of the Allies the Nazis had been in certain key areas.

Jet engines, rocket engines, infrared and thermal-imaging systems, proximity fuses, missiles guidance seekers.... technologies that are integral to most modern aircraft and airborne weapon systems were all listed and described. In the late 1950s, when Lusar's book first appeared, these technologies were still in their infancy in Britain and America.

Yet the Germans had been working on them a decade and a half earlier.



But there was another side to the book, one which was so sensational that immediately on its appearance it had set alarm bells ringing in Washington.

This side of the book related to so-called German 'wonder- weapons' beyond the V-1 and V-2.... Other esoteric developments detailed by **Lusar** showed that the Germans had been working on bringing down Allied aircraft with sound waves, air vortices, intensely focused beams of light and jets of compressed air.

In 1958, the US Air Force commissioned a 'special studies group' within Air Force Intelligence headed by an Austrian-born technical consultant called Dr **Stefan Possony** to carry out a detailed appraisal of Lusar's book. The research effort was branded 'secret' and has only recently come to light....

A section in Lusar's book was devoted to 'flying saucers' which he asserted, in no uncertain terms, were the product of German wartime inventors. 'Experts and collaborators in this work confirm that the first projects, called "flying disks", were undertaken in 1941,' Lusar wrote. He even went on to name the key individuals involved. These were 'the German experts Schriever, Habermohl, and Miethe, and the Italian Bellonzo.'<sup>4</sup>

Cook's thesis is one that will guide our examination of some of the Majic-12 or [Majestic-12 documents](#) in this chapter, with a view to explicating a possible underlying "German" connection to the Roswell crash and cover-up:

Make the link between Germany and the flying saucer and here was an opportunity to solve not only the anti-gravity propulsion riddle, but, in the process, perhaps, one of the most baffling mysteries of the 20th century: the origins of the UFO.... The flying disc must have exhibited performance so in advance of its time that it had been super-classified, then hidden in plain sight - behind the UFO myth - for the best part of 60 years.<sup>5</sup>

However, as **Cook** quickly discovered, the Nazi Legend has a significant problem: **Lusar** mentioned four names, but other than these four names, the testimony for the Legend, until very recently, was based almost completely on hearsay.<sup>6</sup> There were no declassified documents in the 1950s and 1960s to back up Lusar's incredible story. Indeed, it was only with German reunification and the subsequent "declassification spree" that it prompted that corroborating documentation finally became available, and in sufficient quantity and quality to constitute a solid prima facie case.

<sup>4</sup> Nick cook, op. cit., p.

<sup>5</sup> Ibid., pp. 46-47, emphasis added.

<sup>6</sup> Ibid., p. 47.

It is this fact, that the trail into the Legend seems to lead nowhere and yet everywhere at one and the same time, that is the main reason it is so seldom pursued by serious UFO researchers, most of whom simply laugh it off when confronted with it, especially in the North American UFOlogy community.

But the problem with the *Nazi Legend* is really not with its early uncorroborated hearsay testimony, nor even with its then quite unsubstantiated claims in the postwar West German media.<sup>7</sup> The problem was not really with the second-hand or hearsay testimony of a few dead men and a few odd documents claiming a secret provenance deep within the black projects of the Waffen SS.

The problem is that the same basic type of evidence exists for the Roswell incident of the alleged crash of a flying saucer. Beyond the fact that there were a few primary source witnesses - Mac Brazzel, Jesse Marcel, Walter Haut and so on - that researchers such as **William Moore**, **Charles Berlitz** and **Stanton Friedman** were able to interview personally, there are a whole host of secondary testimonies to the event that have surfaced since then. In this very general respect, the dynamics of the Roswell ET Myth and the Nazi UFO Legend are remarkably similar.

And like the Nazi Legend, classified documents showed up to corroborate the story, only this time, the documents were not declassified, but rather, apparently leaked to the UFOlogy community. These are, of course, the now famous (or depending on one's lights, infamous) *MJ-12*, or *Majestic-12*, or *Majic-12 documents*, the primary focus of this chapter.

In the pro-UFO community, much fanfare has been made over the years about the "dozens" or even "hundreds" of eyewitnesses to the alleged UFO crash near Roswell....

In the pro-UFO book *The Truth About the UFO Crash at Roswell*, **Kevin Randle** and **Donald Schmitt** note the fact that **Bill Moore**<sup>8</sup> interviewed "more than seventy witnesses who had some knowledge of the (Roswell UFO crash) event." Indeed, both Friedman and Moore, around the time of the initial publication of the Roswell Incident in 1980, boasted that they had interviewed more than "ninety witnesses."

7 Ibid., p. 47. Rudolf Schriever was the first to recount for the West German media, in the 1950s, the work he had done for the Heinkel company in 1940-1941 on flying disk aerodynes.

8 Co-author, with Charles Berlitz, of the first thorough account of the Roswell crash, *The Roswell Incident*.

While these double digit figures are certainly accurate, the presentation of such a seemingly impressive number of witnesses by themselves, without qualifications, is misleading. The relevant issue is not how many witnesses were interviewed, but rather what type of witnesses (i.e., firsthand, secondhand, etc.) these people are and how truthful and accurate their statements are.

Unfortunately, a careful reading of *Moore and Berlitz's Roswell Incident* reveals that despite the impressive claim of having "interviewed more than seventy witnesses," the testimonies of just twenty-five people are presented. Out of these twenty-five, only seven of them are firsthand sources who claim to have seen the alleged saucer debris, and one of these accounts is suspect. Of these seven people, however, only five of them claim to have actually handled the material personally, and one of them is adamant that it was not from an extraterrestrial spacecraft.<sup>9</sup>

9 Kal K. Korff, *The Roswell UFO Crash*, pp. 28-29. 280

Researcher interviews of a few primary source "eyewitnesses": this much the *Roswell ET Myth* and the *Nazi UFO Legend* have in common. The problem thus posed by the mere existence of the Nazi Legend in this context is therefore very significant: Why does one event form such a stable and consistent foundation in the historiography of the ET-UFO Mythos, and why is the other hypothesis so consistently avoided by the same community, when in general, both the ET explanation of the Roswell incident, and the Nazi UFO Legend are based upon not only the same types of evidence, but initially, the same approximate quantity of evidence? Put differently, why is the ET Myth so predominant in all "unofficial" explanations of the Roswell crash, and the hypothesis of a terrestrially-originated though exotic technology as an explanation consistently avoided?

The answer I believe, lies in some peculiarities of [the Majic-12 documents](#) themselves.

## C. The Majic-12 Documents: The ET Myth vs the Nazi Legend

The *Majic-12 documents* are well-known in UFOlogy circles, and a controversy has ensued over their genuineness and authenticity, or lack thereof. The documents themselves purport to be highly classified top secret memoranda, studies, and so on, concerning the Roswell crash and its aftermath: the establishment of a deep cover, highly classified UFO retrieval, back-engineering, and study group composed of top civilian and military leaders with a large black projects budget. The documents, complete with many blacked out areas - represented by strings of question marks "?????" in the quotations which follow - were leaked to the public in two different sets.

As well known and respected UFOlogist [Stanton Friedman](#) put it, the first set of documents arrived in December of 1984, quite literally "on Jaimie Shandera's doorstep."<sup>10</sup> [Shandera](#), a film director, had contacted Friedman about the possibility of doing a fictional movie concerning UFOs, wanting Friedman to be a consultant for the movie.

10 Stanton Friedman, *Top Secret/Majic* (New York: Marlowe and Company, 1996), p. 20.

Then, in December 1984, the Majestic-12 documents showed up on [Jaimie Shandera's](#) doorstep.

To be more exact, a roll of undeveloped black-and-white 35mm film came in the mail to Shandera's home in Burbank in a double- wrapped plain brown envelope with no return address and an Albuquerque, New Mexico postmark. Why was it sent to Jaimie? One possibility is that it was well-known that Shandera had been working closely with Bill Moore and myself on the Roswell crash story, and that together with Bill, had had many contacts with insiders, some of whom were connected with OSI in Albuquerque.

Bill and Jaime's meetings with Agent [Doty](#) and others had left them with the impression that these insiders were interested in having the facts about flying saucers released to the public, in a manner that would protect their identity and their status. But we may never know.

After Bill and Jaime developed the film, they called me. What they found on the film were duplicate sets of eight pages of documents that were classified *TOP SECRET/MAJIC*, with a title page declaring " [Briefing Document: Operation Majestic](#)

[12 prepared for President Elect Dwight D. Eisenhower: \(Eyes Only\) 18 November, 1952.](#)" The second page listed the members of the Majestic-12 group, all of whom were dead....

Incredible as it sounded, the documents on this film dealt with the New Mexico crashes as well as with the government's efforts to keep them secret. According to the briefing, the wreckage of a crashed saucer was recovered by the U.S. government 75 miles northwest of Roswell in early July 1947. Four small alien bodies, apparently ejected from the vehicle, were found two miles east of the main wreckage site. The government took into its possession the wreckage and the bodies for careful study and evaluation, and in September 1947, officially established [Operation Majestic-12](#) as a "top secret Research and Development/Intelligence operation responsible directly and only to the President of the United States."<sup>11</sup>

Friedman, as any serious investigator would, approached the question of the authenticity of the document cautiously.

There were, as he saw it, three possible explanations of the document, if indeed it was legitimate, and if indeed it was genuinely leaked. The documents could be:

(1) legitimate in the sense of genuinely originating from the military-intelligence community, but they could have been composed or intended to be disinformation or a hoax in some elaborate psychological warfare operation;<sup>12</sup>

(2) legitimate in the sense that they might "contain some truth mixed with some phony material;"<sup>13</sup>

(3) could be "Plain straight legitimate."<sup>14</sup>

<sup>11</sup> Friedman, *op. cit.*, pp. 20-21.

<sup>12</sup>*Ibid.*, p. 22. Friedman actually states it differently: "First, the entire roll of film could be disinformation or a hoax."

<sup>13</sup>*Ibid.*, p. 23.

<sup>14</sup>*Ibid.*

Most of the controversy within the UFOlogical community has centered on options (1) and (3), between those who maintain that they are a simple hoax or part of some disinformation operation, and those who believe that they are 'plain straight legitimate.'<sup>15</sup> Friedman's own case for the authenticity of the "Eisenhower Briefing Document" is thorough and persuasive.

Then, as Friedman, Moore, and Shandera were investigating the *Eisenhower Briefing Document*, a second set of purported Majic-12 top secret documents were leaked, this time to UFOlogist **Don Berliner**, and a mystified man in California named **Timothy Cooper**. In March of 1994, Don Berliner, like Jaime Shandera ten years earlier, received a roll of undeveloped Tri-X film in his mail box. The film contained what was allegedly the actual operations manual for UFO recovery teams called the "[Special Operations Manual](#)."

But the most sensational Majic-12 documents are doubtless those leaked to **Timothy Cooper**, the so-called "[Cooper-Cantwheel Majic-12](#)" documents. Cooper, who had grown up near the White Sands Missile range, had become interested in the subject of UFOs and secret missile research as a youth when someone shared information about UFOs with him. His curiosity piqued, he began research on the top secret facility by filing FOIA requests, assembling a large and thorough collection of government documents. Then in 1992, Cooper began receiving photocopied Majic-12 documents in his mail box from a man calling himself "*Thomas Cantwheel*."<sup>16</sup>

<sup>16</sup> Dr. Robert M. and Ryan S. Wood, *The Secret: Evidence that We Are Not Alone* (DVD disk, 1988); Dr. Robert M. and Ryan S. Wood: *The Majestic Documents* (Redwood City, California: Wood and Wood Enterprises, 1998), p.1. The latter book is simply a reproduction of the document copies received by Cooper, along with a parallel typescript text of the documents for ease of reading, since in many cases the quality of the copies is degraded, making reading of the original document difficult.

Friedman falls into the group arguing for option three:

"Based on my detailed study and investigation of the overall UFO phenomenon beginning in 1958, I am equally certain that,

(1) some UFOs are intelligently controlled extraterrestrial spacecraft;

(2) the subject of flying saucers represents a kind of cosmic Watergate, wherein a relatively small group of people in government have known about the visitors for many years;

(3) none of the anti-UFO arguments made by a small but vocal group of debunkers stand up under scrutiny; and

(4) visits by extraterrestrial space vehicles and the successful 50- year coverup of the best evidence (alien bodies and wreckage) is the biggest story of the millennium."

Cooper contacted Friedman, who was not only well-known in UFOlogy, but by that time well established as an expert on the authenticity issues of the first Majic-12 document, the so-called "Eisenhower Briefing" document. Friedman, living now in Nova Scotia, put Cooper in contact with Robert and Ryan Wood, two associates with some expertise in document authentication. Again Wood and Wood argued quite persuasively for the authenticity of the documents, but again, following option (3), they argued that the documents are "plain straight legitimate."

Two of the Cantwheel Majic-12 documents have become focal points of UFOlogy interest, and for good reason: The "White Hot Intelligence Estimate" of Air Force General Nathan Twining, and the "Majestic Twelve Project First Annual Report." These are the documents that contain actual technical descriptions of the alleged crashed alien craft recovered at Roswell, along with recommendations on what to do about it.

Accordingly, we shall accept the arguments of Robert and Ryan Wood and their exhaustive process of document authentication, and assume that the documents are legitimate, and using internal indications and inconsistencies, we shall argue that these two documents are best interpreted as containing part truth, and part deliberate deception, and that both of these elements point possibly, though nowhere near conclusively, to a terrestrial, and German, origin for the exotic craft that crashed in New Mexico in 1947, and that this is the element that is the ultimate objective of the cover-up, as alluded to by Colonel Corso's statements that form the epigrams to this chapter.

The methodology will be that already hinted at by Corso's statements, and more completely outlined by **Nick Cook**:

Make the link between Germany and the flying saucer and here was an opportunity to solve not only the anti-gravity propulsion riddle, but, in the process, perhaps, one of the most baffling mysteries of the 20th century: the origins of the UFO.... The flying disc must have exhibited performance so in advance of its time that it had been super-classified, then hidden in plain sight -behind the UFO myth -for the best part of 60 years.<sup>17</sup>

<sup>17</sup> Cook, op. cit., pp. 46-47.

In brief, I shall argue that there are two levels at work in the Majic-12, "White Hot Intelligence Estimate" and the "First Annual Report" documents:

(1) A genuine level, in which the technical aspects of the recovered technology are summarized. As will be indicated, there are glaring discrepancies between these descriptions, and a presumption of an extraterrestrial origin, for the recovered technology. Conversely, as will be shown, there are detailed parallels between the descriptions of the recovered technology of the Roswell crash, and the already examined secret weapons black projects of Nazi Germany covered in the previous part of this book;

(2) A level of disinformation, where the emerging "ET explanation" forms a final deep cover layer of disinformation behind the public explanations of crashed weather or Project Mogul balloons.

The resulting clash of these two emphases constitutes one basis for those who would wish to challenge the authenticity of the documents, which they most certainly are.

## 1. The "White Hot Intelligence Estimate " of General Nathan Twining

The "[White Hot Intelligence Estimate](#)" is actually the first part of a Majic-12 document called "*Mission Assessment of Recovered Lenticular Aerodyne Objects and Implications in ??????AR??*".<sup>18</sup> This document is the second examination of the crashed vehicles - note the plural - describing some aspects of the technology retrieved and analyzed by the military after the Roswell incident.

<sup>18</sup> Wood and Wood, *The Majestic Documents*, p. 63. The strings of question marks correspond to the blacked-out areas of the original photocopies.

Besides the standard authenticating features thoroughly investigated by Wood and Wood - typeface comparisons, document style manual and orthography and so on - all of which is strongly in favor of authenticity, there are a number of internal descriptions that do not make sense if the recovered object were of extraterrestrial origin and interplanetary travel capability. That is, the best explanation of this particular document seems to lie not with Friedman's options (1) or (3), but with option (2), that they contain some truth mixed with phony or deliberately distorted material.

As will be seen as we proceed, a disturbing hypothetical scenario begins to emerge if one examines this document not from the interpretive paradigm of the ET Myth (option (3)), but from the perspective of the Nazi Legend (and option (2)). In arguing for this latter interpretation of the document, we shall focus on three key areas:

- (a) Odd language of a general nature describing the UFO phenomenon and areas and types of activity as they were then known;
- (b) incongruous technical language that describes something simultaneously both very advanced, and yet very commonplace;
- (c) ambiguous language reflecting perhaps an amount of indecision or hesitation concerning the nature of what was recovered, and what to do about it.

With these thoughts in mind, we begin by noting the first and most obvious point: both the Roswell crash and [Admiral Byrd's Operation Highjump](#), with the admiral's astounding statement in the South American Chilean El Mercurio, occur in the same year, within a few months of each other.

### **(a) Odd Language of a General Nature Describing the UFO Phenomenon and Its Area and Types of Activity**

After a brief history of the postwar UFO phenomenon, beginning with Kenneth Arnold's June 1947 sighting, the document then points out the apparent interest of "ET" in our military installations:

"Numerous sightings over military installations in the state of New Mexico were investigated by Army and Navy intelligence officers."<sup>19</sup>

The report also mentions sightings in "Sweden and Germany, Holland, Paraguay, Scandinavia, Greece, by ships at sea."<sup>20</sup>

<sup>19</sup> Ibid., p. 65, par. 5.

<sup>20</sup> Ibid., p. 65, par. 6.

A typical explanation from the ET paradigm is that UFOs began to exhibit an interest in our military installations and increased their monitoring activities of the human race after it had mastered nuclear energy and weaponized it in the atom bomb, possibly fearing that we might venture into outer space and bringing our warlike habits and weapons of mass destruction with us. As an explanation of "their" then evident "observe but do not contact" behavior, this is plausible. We were being surveilled, if not reconnoitered. But such behavior in itself means nothing, for such patterns could equally describe monitoring and surveilling operations of wholly terrestrial but unknown origins.

Note also the curious wording of paragraph 6: "Sweden and Germany....Scandinavia." Why the redundancy? A possible explanation, though one not indicated by the document itself, is that two different types of phenomena might be being referred to. However, "Sweden and Germany, Holland, Paraguay, Scandinavia, Greece" and "ships at sea" would not seem to be of the same interest to "ET" if the purpose of the monitoring activity was, as some like Friedman have suggested, to measure human progress in atomic energy applications and weapons. This vague inconsistency then becomes more acute once attention is focused on the technical descriptions of the document.

### **(b) Technical Language that Describes Something Simultaneously both Very Advanced, yet Very Commonplace**

Perhaps the best evidence that the document should be interpreted as being both genuine and yet containing "phony" or "faked" elements concerns the technical descriptions and references. For example, immediately after the odd reference to sightings in Sweden and Germany and then "Scandinavia", the document then goes on to record the "extraordinary capabilities" of the recovered craft:

Of the 1,200 sighting reports collect (sic) since 1942 approximately 200 incidents have proven to be unknown craft operation (sic) at speeds in excess of 1200 MPH and at times attaining altitudes up to ?? miles or more above the earth. A comparison was made with Swedish Defense officials of the reported operating ?????? a sec? intelligence liaison official????? Continuing views of restricted air space over sensitive Swedish military base has not indicated any direct ???????????? tangible evidence thus far that would suggest ?????? are the ??????????.<sup>21</sup>

<sup>21</sup> Ibid., pp. 65-66, par. 7, emphasis added.

While speeds of 1,200 MPH were indeed extraordinary for any aircraft of the day (and even today), and hence noteworthy enough to be noted in the document, and while performance characteristics that enabled these craft to achieve altitudes of some unknown number of miles above the earth were likewise equally if not more extraordinary, the important point to notice is that such speeds are certainly not the extreme characteristics that one would expect of a product of an advanced "ET" civilization with interstellar, or even interplanetary capability limited to our own solar system.

To put it succinctly, the performance characteristics described are not advanced enough to be extraterrestrial in origin.

Note that if the craft's speed were in the area of a mere 1,200 MPH, as this portion of the document states, then the use of such a craft for interplanetary exploration would seem to be absurd in the extreme, particularly if it is maintained that these craft originated from outside our solar system, which is the presumption implicit with every "ET" interpretation of the Roswell event. If one conceded top speeds of even ten thousand miles per hour for the craft, then a trip to Mars, our closest planetary neighbor at approximately 36,000,000 miles from the earth, would take 150 days.

At a mere 1,200 miles per hour, however, a journey to Mars would take about 1250 days, or almost three and a half years, and neither of these figures is even factoring in the positions of the planets at any given moment of their orbital periods around the sun nor the curved trajectory such craft would have to follow between the two planets! As will be obvious, however, such performance characteristics are within the performance capabilities suggested by the advanced German aircraft technologies being developed by Kammler's "think tank."

When one thus turns to the actual first part of the document after this historical overview, the technological ambiguity is only increased, rather than assuaged. The first part of this detailed technical assessment is called "Project White Hot Intelligence Estimate (Preliminary)."

Here it is necessary to cite the document at length:

#### **PART I** **LANDING ZONE NO. 1**

Socorro, New Mexico -The unidentified lenticular-shaped aerodyne which has been designated ULAT-1, has been evaluated as a non-air breathing aircraft of unknown origin. Totally lacking conventional wing, fuselage, nacelle, control, and fuel systems strongly indicates it is not Russian. Consultation with Paperclip specialists concur. Aerodynamic features exhibited in ULAT-1 represent a very high degree of engineering and sophistication not seen in this country. Dimensional homogeneity study cannot explain how this craft sustains load and lift factors necessary for flight.

The power plant does not resemble any conventional type now in use. Lacking any discernible intake or exhaust features, it is the opinion of AMC and ONR that this craft was designed to operate outside of the earth's atmosphere. The unconventional conclusions reached by members of this fact-finding mission remain tentative at this time. Some members expressed the view that ULAT-1 may be the product of an advanced culture from another planet that is much older than ours and has utilized the science and intellect for interplanetary space travel.

It is not precisely known if the occupants purposely had the objective of exploration out of curiosity or with the intent of surveying for other reasons. So far, no hostile intent has been observed since they made their presence known. Given the fact that our atomic bomb tests, atmospheric exploration with rockets, and ????????ed in New Mexico, could have precipitated the events that led to the incident and subsequent actions taken by the military.

Operating under the assumption that the fallen object was a long- range Russian reconnaissance platform collecting aerial photographic intelligence data, military intelligence personnel were instructed to secure the craft, debris and the occupants as rapidly as possible. Concerns over possible exposure to civilians of known biological and chemical agents dictated the quarantine measures taken. Radiation hazards were assumed and appropriate protective measure were taken as well.

In the interest of National Security priorities it was necessary to detain civilian witnesses for interrogation to satisfy intelligence requirements, and quash rumors that could alert potential espionage agents known to be in the vicinity.

Several bodies were discovered. Because on-site medical personnel were unsure of the physiological and biological make-up of the occupants, special preparations and preservation methods were employed Autopsy information obtained so far suggests that the occupants mimic the features associated with Orientals. Outwardly they appear human-like with but one exception: autopsy notes mention a rarely observed ??????s present which supports the premise that these beings originate from another planet.<sup>22</sup>

22 Ibid., pp. 67-68, emphasis added.

There are two sets of factors in this quotation that, taken separately, seem to argue persuasively that one is dealing with an extremely advanced but nonetheless very terrestrial phenomenon, or that, conversely, argue persuasively that one is dealing with a very advanced extraterrestrial phenomenon, but that taken together present an ambiguous and puzzling picture. It is their occurrence in the same context, without apparent analysis or attempt to resolve the ambiguity, that requires interpretation and explanation.

Note first of all that, at this stage of the "preliminary investigation" the origins of the craft remain, in its own word, "unknown." But a little later on the document indicates that there was apparently some internal dissent in the preliminary study group: "Some members expressed the view that ULAT-1 may be the product of an advanced culture from another planet..." In other words, there appears to have been genuine indecision and hesitancy on where to attribute the origin of the craft.

This tends to be an internal corroboration and consistency with what we have already observed above regarding the recovered technology and the craft's performance characteristics, for apparently the recovered technology, considered as a factor in and of itself, is not sufficiently advanced enough to argue on its own basis for an extraterrestrial origin. What does argue for the extraterrestrial nature is not the recovered technology, but the recovered biology. It is the clash of these two sets of facts, then, that appears to be behind the hinted-at internal dissent in the study group when it came to the question of origins of the recovered vehicle.

There is another technological bombshell that deserves to be weighed carefully in the light of what has already been stated regarding the Nazi UFO Legend and Kammler's think tank:

"Totally lacking conventional wing, fuselage, nacelle, control and fuel systems strongly indicates it is not Russian. Consultation with Paperclip specialists concur."

The question that now inevitably arises is this: Would the US military have been likely to consult the nearby former Nazi rocket scientists in its employment if it even remotely suspected that what had fallen into its hands was something extraterrestrial, and thereby, technologically extremely advanced and sophisticated? I think it is possible, but very unlikely.

The more likely explanation was hinted at by Colonel **Corso** himself in the epigrams that began this chapter: the German Paperclip scientists were shown the recovered vehicle, which on Corso's own admission looked like one of the Horten brothers' flying wings, because the craft itself and its performance characteristics were highly suggestive of similar high performance and unconventional aerodynes under development by Nazi Germany.

In this context, the very next statement is perhaps very telling and suggestive, for the language is very careful and deliberate:

"Aerodynamic features exhibited in ULAT-1 represent a very high degree of engineering and sophistication not seen in this country."<sup>23</sup>

23 Ibid., p. 67, emphasis added.

If an "ET" origin were suspected, and that explanation already agreed upon, then the sentence would have read "Aerodynamic features exhibited in ULAT-1 represent a very high degree of engineering and sophistication not seen on this planet." So what country is meant here, and in this context? Only three countries are immediately represented in the previous discussion. Was it Russia? Germany? or the United States? Once again, the language retreats into ambiguity, though the clearest explanation is that the country referred to is the United States, otherwise, why bring in the German Paperclip scientists to render their opinion?

At this juncture an odd transition occurs, for in the segue to the discussion of the recovered bodies, the "ET" myth begins to surface in this context as a plausible explanation for explaining the UFOs' military-style surveilling activities, activities begun, so the document surmises, in response to humanity's detonation of atom bombs during the war and after. This explanation, in fact, was arrived at years later, and quite independently, by astute UFOlogists such as Friedman.

With the mention of recovered bodies the segue is complete, and one is now confronted by a set of data and descriptions totally at variance with the technical data and the data-set favoring terrestrial origins hypothesis:

"Several bodies were discovered....Outwardly, they appear human-like with but one exceptions.... a rarely observed....," and then follows a blacked out area.

A rarely observed what? Presumably a rarely observed physiological feature in humans, but evidently recurring in all of the recovered bodies. Was it a rare blood type or blood disease? Webbed toes and digits? Extra or missing fingers? We do not know.

But having blacked out this all-important and conclusive feature, the document then concludes that this "rarely observed something" supports "the premise that these beings originate from another planet." Note then that, as far as the document itself is concerned, it is not the recovered technology but the recovered biology that argues the most persuasively for the ET origins of the craft. But this conclusion, as it stands, is for us, if not for the writer and compiler of the report itself, an argument from silence. The ET explanation is therefore the weaker of the two explanations internal to the document as they have been publicly redacted and received.

The second part of the document is entitled "Technical Evaluation (Preliminary)." Here it will be necessary to cite this part of the document in full, including once again the blacked out portions, in order to exhibit the full extent of the contradictory nature of these two very different data-sets.

## **PART II**

### **TECHNICAL EVALUATION (PRELIMINARY) ULAT-1**

1. Upon close examination of the exterior surfaces of the craft's fuselage, metallurgists found the skin to be of a ferrous metal white in color. The metal exhibits all the characteristics of high-grade steel. It was determined that the steel was cold-formed and heat-treated. Tensile strength was estimated in excess of 150,000 pounds per square inch. Shear tests give the metal a durability rating about 175,000 pounds per square inch, making the fuselage extremely strong and heat resistant.
2. Static and pressure flow simulations were impressive. The low profile ratio of 6-to-1 gives the aerodyne a great advantage in overcoming the restrictions of the boundary layer effect in high performance operations.
3. Spar flanges are constructed in unusual kinematics design which is believe (sic) to allow strain relief at supersonic speeds. There were no visible signs of plate-stiffeners. There were no fasteners, weld (sic), rivets, or fitting holding the fuselage together.
4. Lack of wings, flaps, stabilizers, and surface control features suggests that the craft is a lifting body.
5. There are no air intakes or exhaust.
6. There are no cables.
7. There are no identifiable electronics (wiring, ignition, lights, instrument, compartment, engine, motors, vacuum tubes, solenoids, generators, heaters, etc.)
8. The power plant (severely damaged) ?????????? neutronic engine. ?????????? Detected. Heavy water and deuterium (light hydrogen) elements appear to be the primary igniter. A series of coils and heavy magnets connected to the neutronic engine via an oddly arranged group of electrodes (metal not yet identified) appears to be the motive force. One small motor was examined. It is encased in a pure aluminum capsule directly underneath the main engine compartment. There is a small exhaust aperture that has what can by (sic) only described as an helicoids mechanism ?????????????????? the auxiliary motor may be articulated.
9. Navigation and engine controls may be activated by tactile manipulation. Viewing may have been achieved by some form of television imagery. Symbolic notation appears to be in the form for flight and control indicators. Flat panels of unknown metal has (sic) been suggested as a device associated with the operation of the aerodyne was discovered and analyzed. Its mode of operation and purpose is unknown.

The absence of provisions, berthing compartments and storage areas suggest the notion that this craft may be a short range reconnaissance platform. The only recognizable features examined were five hand ??????? with arm rests fashioned for vertical and horizontal flight. A leaf book of ?????...

And here, almost an entire page of the document is blacked out, i.e. approximately two double-spaced typewritten pages. The document then continues:

Mode of operation is believed to be instrumentation and suggests that the aerodyne from reconstruction of available wreckage t??????" bio-sensory and optical stimuli for these reasons:

- a. Absence of indicator lights;



- b. Absence of linear dials, or moving pointers;
- c. Absence of counters;
- d. Absence of scopes;
- e. No mechanical signal indicators.

1. There were no identifiable control types found among the assortment of artifacts that would indicate the operation of the propulsion unit was manually activated: no knobs, push-buttons, toggle switches, levels, balls, handwheels, handcranks, or foot-pedals were observed in interior space of the flight cabin.
2. The apparent lack of additional clothing and equipment reinforces the belief that the occupants were engaged in a purely exploratory flight.
3. It is not presently known if electromagnetic radiation effects from the power plant had contributed to pilot error or death before impact. If inadequate shielding was the primary cause of pilot error, ???????????s detected....
4. A very tentative working theory was expressed by the scientific members of the inspection team that pilot-aerodyne interaction may occur via electronic-non word symbols perceived through the tactile manipulation of the fingers, feeding impulses to the brain and vice versa. All of which may suggest a non-inert quality of the materials existent as being a product of artificial intelligence.
5. The following elements were analyzed and found to exist in the small neutronic power plant that was found inside ULAT-1:

- a. UF6 in metallic form;
- b. Hydrogen-fluoride gas;
- c. Water and uranium tetrafluoride;
- d. Powdered magnesium and potassium chlorate;
- e. Metal similar to lead with a chocolate brown color;
- f. U-235 in metallic form;
- g. Plastic like material similar to NE 102;
- h. Beryllium,
- i. Pure aluminum;
- h. Thorium isotope material;
- j. plutonium powder.<sup>24</sup>

- i. Scientists from Los Alamos and Sandia Base were alarmed that the power plant could possibly function as a bomb if the elements described above were processed in similar fashion as was done for the lens and shotgun detonators.<sup>25</sup>
- ii. The only evidence of circuitry found on the motor was thin plastic-like sheets fashioned like platters embossed on the exterior of the spherically-shaped casing coated by a thin film of pure silver. Under high power magnification it was observed a series (sic) of fine grid-like lines intersecting groups of dots arranged in circular patterns.

**24 Note that the ordering here is that of the original document. As the Drs. Wood suggest, this flaw argues strongly for the document's authenticity. I concur.**

**25 The lens detonator refers to the implosion device used in plutonium based atom bombs to compress the critical mass. The device was described in part one. The shotgun detonator refers to the critical mass assembly mechanism in uranium-235 based atom bombs.**

### **PART III**

#### **SCIENTIFIC PROBABILITIES**

1. Based on all available evidence collected from recovered exhibits currently under study by AMC, AFSWP, NEPA, AEC, ONR, NACA, JRDB, RAND, USAAF, SAG, and MIT, are deemed extraterrestrial in nature. This conclusion was reached as a result of comparisons of artifacts from the Missouri discovery in 1941. The technology is outside the scope of US science, even that of German rocket and aircraft development.
2. Interplanetary space travel is possible provided adequate funding, necessary resources are made available, and national interest is piqued.
3. Human origins may not be constrained to one planet. Our genus may be found among solar systems similar to our own.
4. The laws of physics and genetics may have a genesis in a higher, structured order that once (sic) previously thought.<sup>26</sup>

26 Wood and Wood, op. cit., pp. 69-75, emphasis added. All strike-through typeface are in the original.

We are now in a position to summarize once again the two data- sets - the ET data set and the terrestrial-origins data-set - and the internal contradictions these present in the document.

We begin with the conclusion the document reaches after the lengthy summary of the technical data:

"Based on all available evidence collected from recovered exhibits currently under study by AMC (etc.)...are deemed extraterrestrial in nature."<sup>27</sup>

Note then what has happened within the same document. What began as an open-ended discussion, with either the terrestrial or extraterrestrial explanations being left more or less an open question in Part I of the document, quickly becomes a definitive conclusion in favor of the ET hypothesis by Part III, after Part II mentioned that "rarely observed something" as being evidence for an ET origin of the recovered bodies. Thus, what is otherwise an extraordinary but nevertheless terrestrially explainable list of technical components in Part III becomes deftly reinterpreted within the ET paradigm that formed the transition from Part I to Part III.

It is to be admitted that some of the technical descriptions found in Part III would baffle most engineers of 2004, not to mention those of 1947:

"there were no visible signs of plate-stiffeners. There were no fasteners, weld, rivets, or fittings holding the fuselage together."<sup>28</sup>

Another unusual technological feature that, in 1947 at least, would have argued strongly for an ET origin of the craft was the apparent biological-mechanical "interface" between pilot/crew and the craft that allowed immediate brain-craft control interaction, and which would have accounted for the apparent lack of normal control surfaces that was noted in he report:

"symbolic notation appears to be the form for flight and control indicators. Flat panels of unknown metal has (sic) been suggested," and so on.<sup>29</sup>

27 Ibid., p. 75., PT III, par. 1.

28 Ibid., p. 69, f 3.

29 Ibid.

While this type of biometric technology is now known - and employed - by today's western military forces, it was only a science fiction dream in 1947. This fact led Colonel **Corso**, for example, to reveal that such technology was gradually "seeded" into American industry once its principles of operation were known. Finally, the most exact description of an advanced technology in apparent advance of 1947 American capabilities is found at the very end of Part II, with its description of thin plastic sheets coating by a film of silver on which was inscribed a fine grid like pattern of lines, circles and intersecting patterns. What is described here sounds very much like a 1947 description of an integrated circuit.

But what is remarkable is the conclusion drawn from all this technical detail: "Interplanetary space travel is possible..."<sup>30</sup> This is the conclusion reached by analysis of all the preceding extensive technological summary. Yet, the document's own stated "observed characteristic" - speeds of a mere 1,200 MPH - do not support this conclusion at all, as was previously noted. One is in the presence, in other words, of two very different data-sets, even where the technology is concerned.

However, it is equally crucial to observe that all other technological data points can be explained by reference to specific achievements of the Nazi secret weapons research. We will now consider these in detail. The metal of the craft, we are initially told, is some white-colored iron-based metal having the characteristics of high grade steel that was "cold-formed and heat treated."<sup>31</sup> The process of forming and molding high tensile steel was in fact called "cold extrusion" and it was a technology that the Germans had perfected during the war. Moreover, the document also notes that the "lack of wings, flaps, stabilizers, and surface control features suggests that the craft is a lifting body,"<sup>32</sup> a design principle well in keeping with the most advanced German wartime research into discoid aerodynes.

A further connection to known Nazi research interests is found in paragraph two: "The low profile ratio of 6-to-1 gives the aerodyne a great advantage in overcoming the restrictions of the boundary layer effect..."<sup>33</sup> layer, as we have already seen, formed an early focal point of secret German research undertaken even before the beginning of the World War.

30 Ibid., p. 75, par. 2.

31 Ibid., p. 69., par. 1.

32 Ibid., p. 69, par. 4.

33 Ibid., par. 2.

But now the internal contradictions in the document become stark and acute. For example, there is a curious juxtaposition and contradiction between paragraphs seven and eight. Paragraph seven states that "there are no identifiable electronics (wiring, ignition...etc),"<sup>34</sup> and yet, in the very next paragraph, we are informed that, in the arrangement of technologies in the "neutronic engine" there are "a series of coils and heavy magnets connected to the neutronic engine via an oddly arranged group of electrodes (metal not yet identified)."<sup>35</sup>

Coils and magnets certainly constitute "identifiable electronics," so what is apparently really in view is the "oddly arranged group of electrodes," suggesting that it is not the technology as such that is unusual, but its design and arrangement and combinations. And the description of this odd arrangement and spherical electronics sounds suspiciously like Hans Coler's "coils" and the *Shneppeller devices* previously examined. So here too, the document seems to point not so much to something extraterrestrial, but to something that, while exotic, was very terrestrial, and uniquely German. It is perhaps even significant that the document mentions a design feature we encountered in the turbines and rotational devices of **Viktor Schauburger**: a "helicoid mechanism."<sup>36</sup>

One would expect from such advanced "extraterrestrial" technology such as this at least some sort of solid state electronics and better speeds than a paltry 1,200 MPH and an engine constructed of coils and magnets "oddly arranged." Then there is, from the terrestrial origins point of view another giveaway: "The absence of provisions, berthing compartments and storage areas suggest that this craft may be a short range reconnaissance platform."<sup>37</sup> Certainly this statement could be made to fit with an "ET" explanation, but it is equally true that it is more appropriate to a terrestrial origins interpretation.

34 Ibid., p. 70, par. 7.

35 Ibid., par. 8.

36 Ibid.

37 Ibid., par. 9.

Finally, the oddest mention in the whole of the document's Part II: a "leaf book" whose contents are apparently so sensitive that no part of the presumed summary of its contents is leaked. The entire description is blacked out. This is extremely interesting, and another point of internal contradiction, for in the light of the description of integrated circuitry encountered above and any culture possessing it, digital data storage is possible. Surely an advanced extraterrestrial culture with interplanetary travel capability would have a more advanced technology for data storage than a book.

Yet there is no mention in the whole document of anything that resembles digital data storage systems. There are no cassette tapes, no compact disks, no nothing. This is not to say that ET would not have, nor read, books. After all, we possess both technologies, and continue to use both. But in any case, it cannot be denied: a book is a totally terrestrial, and well-known, and old technology.

Perhaps the most interesting technical descriptions, however, are to be found in those portions describing the "neutronic engine." Eleven components are described:

- (1) UF<sub>6</sub> (i.e., uranium hexafluoride) in metallic form
- (2) Hydrogen-fluoride gas
- (3) "water" and uranium tetrafluoride
- (4) powdered magnesium and potassium chlorate
- (5) a "metal similar to lead with a chocolate brown color"
- (6) U<sub>235</sub> in metallic form
- (7) a plastic like material similar to (DuPont's) NE 102
- (8) beryllium
- (9) pure aluminum
- (10) "thorium isotope material"
- (11) plutonium powder

There are a number of very odd features about this list.

First note that nine of the eleven components of the "neutronic engine" describe wholly terrestrial - though for 1947 - still very advanced technologies.

Second, note that the document states clearly that these elements "were analyzed and found to exist in the small neutronic power plant."<sup>38</sup> So the elements were subjected to chemical and presumably other types of analysis, such as

spectroscopy. One may even speculate where they were analyzed: close by in the Los Alamos laboratories, one of the few facilities in the country at that time, and certainly the only one in New Mexico, capable of handling and analyzing such exotic and radioactive material.

It is in this context that the third odd feature becomes evident, for the isotopic form of uranium - U235 - is clearly specified, suggesting that the necessary technique of analysis employed was precisely spectroscopy, since chemical analysis cannot separate isotopes of the same element. We may also assume that this analysis indicated a high degree of purity, since one of the concerns of the scientists involved was precisely that the uranium could be used for a bomb, which means that it was of weapons grade purity. And we may likewise safely assume that the plutonium present was Pu240 the stable plutonium isotope.<sup>39</sup>

**38 Ibid., p. 74, par. 18.**

**39 Another factor now should be noticed. The presence of these two elements without any mention of proper shielding indicates a serious technical flaw in the document, notwithstanding its external indicators of authenticity.**

With this in mind, a question immediately resents itself: Why is there an ambiguity when it comes to "thorium isotope material?" Was this because it was an unknown isotope? Unlikely, since precision is indicated in the case of the uranium, and implied in the case of the plutonium. Was it therefore not specified for some other reason? We will never know.

This leads to yet another oddity. There is a peculiar blend evident throughout this list of very precise, and very ambiguous, descriptions that, given the importance of the subject matter, should not be glossed over. It may be the case that there was not sufficient time to test and analyze everything precisely, but surely the presence of "thorium isotope material" merited further precision. In this respect, note once again that uranium tetrafluoride and uranium hexafluoride are both precisely indicated, but again, with an imprecision: what was the isotopic form?

This ambiguity is perhaps most evident in the mention of "water," for one is left to guess whether this is ordinary water, or heavily deuterized or tritiumized heavy water. This imprecision occurs in the same context where earlier precision is the order of the day, for in paragraph eight, "heavy water" and "deuterium" are mentioned as the "primary ignitor" of the neutronic engine.<sup>40</sup>

In any case, these nine out of the eleven components are all known terrestrial technology, and given what has been covered in this book previously, well within known German and American capabilities, and, for that time, only within German or American capabilities. In other words, if these are indicators pointing to a terrestrial origin for the craft, then the only other possible place it can point to besides the United States, is the Nazi secret weapons project and its possible postwar offshoots. This may be the reason why, then, when the two data-sets come into conflict at various points in the document, the ambiguity is obfuscated in favor of an extraterrestrial hypothesis of the craft's origin.

One final note before proceeding with the examination of other documents from the Cooper-Cantwheel Majic-12 series of paper; the mention of water and uranium tetrafluoride suggests the remote possibility that a highly radioactive solution was being employed, presumably to manipulate neutron emission in conjunction with the hydrodynamic properties of fluids. This manipulation of radioactivity, field effects, and hydrodynamic properties - exotic by even today's standards - was also, as was seen, one apparent principle behind the operation of Kammler's "Bell". Thus, even in its descriptions of the most arcane aspects of the craft, the indications point clearly to Germany.

While all these points constitute to my mind a very strong set of data points coupling the Roswell craft to the secret weapons research of Nazi Germany and therefore to a possible terrestrial origin of "ULAT-1", the document concludes with two very suggestive, and for that day, advanced and revolutionary concepts that favor the "ET" explanation. First, it states clearly that "Human origins may not be constrained to one planet. Our genus may be found among solar systems similar to our own."<sup>41</sup>

**40 Ibid., p. 70, par. 8.**

**41 Ibid., p. 75, par. 5.**

The only possible foundations for this astonishing conclusion would appear to be the autopsies purportedly done on the recovered bodies, but also perhaps based upon analysis of the contents of the "leaf book discovered in the craft. But then an even more extraordinary comment follows:

"The laws of physics and genetics may have a genesis in a higher structured order that once previously thought."<sup>42</sup>

**42 Ibid., p. 75, par. 6.**

In 1947 physics was well on the path toward the grand theoretical constructs of the 1960s, 70s, and 80s, having already seen the higher dimensional theories of Kaluza-Klein and other theories attempting such "higher structured orders." But genetics and biology in general had then no similarly grand and formally explicit conclusions beyond the theory of evolution, which was a long way from maintaining the grand physics-biology union in a higher structured order manifest in the statement.

Watson and Crick had yet to announce their discoveries, and Soviet physicists were still decades away from their astonishing work in the physics of living systems and consciousness. So apparently something in that "leaf book" convinced the study group, during the short period from the crash in July to September of 1947 when the report was actually completed, that there was a grander union of physics and biology than anyone could scarcely have imagined.

So what can be concluded from this one document? I think it is safe to say, that taken as a whole, with both data-sets viewed together, that it tends to favor neither the ET explanation nor the terrestrial origins explanation. However, when viewed separately, the biological information certainly tends to favor the ET origins hypothesis, and the technological information a terrestrial - and German - one. If one then places these two facts within the wider context of other events of 1947, and recalls also the fact that the German Paperclip scientists were brought in because what was recovered "looked all too familiar," then in that broad context the document seems to favor the terrestrial hypothesis. And as we have argued, that points clearly to America or Germany as the only two logical places such technology could have originated.

On this speculative reading of the document, it seems clear then that the apparent contradictions are either deliberately created, or at the minimum, obfuscated in favor of the ET explanation. The cover-up has already begun. Can this type of analysis be sustained on technological information contained in the other great summary of data, the "Air Accident Report" by General Nathan Twining? Indeed it can.

## 2. The 16 July 1947 Air Accident Report by General Nathan Twining to Headquarters:

This document constitutes the next focus of technological interest, for it is General Nathan Twining's report to the Air Material Command (AMC) at Wright Field in Dayton, Ohio. Officially titled "*Air Accident Report on 'Flying Disc' aircraft near the White Sands Proving Ground, New Mexico,*" this report is of singular importance, as it contains the first on-site technology descriptions and assessments. In other words, these descriptions occur before the preliminary review of this September report we have just finished examining.

Again, the main body of the report is cited almost in full:

1. As ordered by Presidential directive, dated 9 July 1947, a preliminary investigation of a recovered "Flying Disc" and remains of a possible second disc, was conducted by the senior staff of this command. The data furnished in this report was provided by the engineering staff personnel of T-2 and aircraft laboratory, Engineering Division T-3. Additional data was supplied by the scientific personnel of the Jet Propulsion Laboratory, CIT and the Army Air Forces Scientific Advisory Group, headed by Dr. **Theodore von Karman**. Further analysis was conducted by personnel from Research and Development.
2. It is the collective view of this investigative body, that the aircraft recovered by the Army and Air Force units near Victorio Peak and Socorro, New Mexico, are not of US manufacture for the following reasons:

a. The circular disc-shaped "plan-form" design does not resemble any design currently under development by this command nor of any Navy project.

b. The lack of any external propulsion system, power plant, intake, exhaust either for propeller or jet propulsion, warrants this view.

c. The inability of the German scientists from Fort Bliss and White Sands Proving Ground to make a positive identification of a secret German V weapon out of these discs. Though the possibility that the Russians have managed to develop such a craft, remains. The lack of any markings, ID numbers or instructions in Cyrillic, has placed serious doubt in the minds of many, that the objects recovered are not of Russian manufacture either.

d. Upon examination of the interior of the craft, a compartment exhibiting a possible atomic engine was discovered. At least this is the opinion of Dr. Oppenheimer and Dr. von Karman. A possibility exists that part of the craft itself comprises the propulsion system, thus allowing the reactor to function as a heat exchanger and permitting the storage of energy into a substance for later use. This may allow the converting of mass into energy, unlike the release of energy of our atomic bombs.

The description of the power room is as follows:

(1) A doughnut shaped tube approximately thirty-five feet in diameter, made of what appears to be a plastic material, surrounding a central core (see sketch in Tab 1) This tube was translucent, approximately one inch. The tube appeared to be filled with a large rod centered inside the tube, was wrapped in a coil of what appears to be copper material, ran through the circumference of the tube. This may be the reactor control mechanism or a storage battery. There were no moving parts discernable within the power room nor in MISSING LINE HERE.

(2) This activation of a electrical potential is believed to be the primary power to the reactor, though it is only a theory at present. Just how a heavy water reactor functions in this environment is unknown.

(3) Underneath the power plant, was discovered a ball- turret, approximately ten feet in diameter. This turret was encompassed by a series of gears that has a unusual ratio not known by any of our engineers. On the underside of the turret were four circular cavities, coated with some smooth material not identified. These cavities are symmetrical but seem to be movable. Just how is not known. The movement of the turret coincides with the dome-shaped copula compartment above the power room. It is believed that the main propulsion system is a Modeless turbine, similar to current development now underway at AMC and the Mogul Project. A possible theory was devised by Dr. August Steinhof,<sup>43</sup>

Dr. Wernher von Braun and Dr. Theodore von Karman as the craft moves through the air, it somehow draws the oxygen from the atmosphere and by an induction process, generates a atomic fusion reaction (see TAB 2). The air outside the craft would thus be ionized, thus propelling the craft forward. Coupled with the circular air foil for lift, the craft would presumably have an unlimited range and air speed This may account for the reported absence of any noise and the apparent blue flame often associated with rapid acceleration.

(4) On the Deck of the power room there are what resembles typewriter keys, possibly reactor/powerplant controls. There were no conventional electronics not wiring to be seen connecting these controls to the propulsion turret.

e. There is a flight deck located inside the copula section. It is round and domed at the top. The absence of canopy, observation windows/blisters, or any optical projection, lends support to the opinion that this craft is either guided by remote viewing or is remotely controlled.

- (1) A semi-circular photo-tube array (possibly television).
- (2) Crew compartments were hermetically sealed via a solidification process.
- (3) No weld marks, rivets or soldered joints.
- (4) Craft components appear to be molded and pressed into perfect fit.<sup>44</sup>

43 A Paperclip scientist.

44 Ibid., pp. 25-26, emphasis added.

There are a number of very similar, and strikingly dissimilar features between this earlier document and the later September "White Hot Intelligence Estimate."

First, it is to be noted that in this very first report there is no mention whatsoever of the extraterrestrial hypothesis as an explanation of the origin of the craft. Perhaps this is explained by the relatively brief time that had elapsed since the crash and the composition of the report, but it is unlikely for a very important reason. The report clearly states that the "German scientists from Fort Bliss and White Sands Proving Ground" were unable "to make a positive identification of a secret German V weapon" from the discs.<sup>45</sup>

This means that the question of origin was in view from the outset, and yet there is no mention of an extraterrestrial hypothesis. This reinforces our previous analysis of the "White Hot Intelligence Estimate", for if the craft was suspected of being extraterrestrial technology from the very beginning, brimming full of ultra-advanced ET technology, then it is very unlikely that the German rocket scientists would have been privy to the discovery at all, given the heavy American compartmentalization of secret research. In other words, to put the point once again, something about the craft immediately suggested a terrestrial and German provenance. By a similar line of reasoning, the German rocket scientists were not able to identify it as any German V-weapon. But this may be obfuscation of a sort, for as **Corso** has indicated, the Germans clearly told General Twining something that did not make it into either of his reports.

Second, unlike the later "[White Hot Intelligence Estimate](#)", the element of "*mystification*" on the part of the investigators is relatively lacking in this initial report. This may obviously be due to the fact that the craft has not yet been more fully analyzed. Yet, the report itself provides an amount of detail that belies this explanation, for it was apparently known in

sufficient detail for von Braun and von Karman - who were unable to identify the craft - to suggest a very radical form of propulsion via a charge differential, a fact that suggests that while they may not have been able to identify it, they at least may have had their strong suspicions.

Third, the strangely and almost single-mindedly "terrestrial" nature of the technology described should be clearly obvious: a simple plastic tube, approximately an inch in diameter, filled with a substance that is apparently water, in the center of which is a rod wrapped with a coil of "what appears to be... copper material."<sup>46</sup>

45 Ibid., p. 25.

46 Ibid.

47 Ibid., p. 26.

Moreover, apparently enough examination or analysis and speculation had been done for the investigators to conclude that the doughnut reactor was somehow a "heavy water" reactor,<sup>47</sup> and that the German scientists are already thinking in terms of a fusion rather than a fission reactor. This is perhaps significant, for the equipment described, in the context of fusion, suggests the same apparatus set up, in some respects, as the process later known as cold fusion.<sup>48</sup>

Fourth, it is to be noted that the craft is described in similar terms to those in the "White Hot Intelligence Estimate" in the fact that it has "no weld marks, rivets or soldered joints."<sup>49</sup>

But this similarity highlights the fifth point, and a significant new difficulty. In the previously examined "White Hot Intelligence Estimate," a certain emphasis was placed by that report on the apparent lack of conventional means of control: push-buttons, knobs, toggle switches, and so on. "Biosensory" control was posited, and these two facts supported an extraterrestrial explanation of the craft's origin. Moreover, the "White Hot Intelligence Estimate," it will be recalled, emphasized the absence of crew quarters, which it will be recalled, suggested a short range reconnaissance platform.

However, here in his very first report, Twining states that "crew compartments were hermetically sealed: and that the means of visual steering of the craft was (suggestively) by "remote viewing," followed immediately by mention of "a semi-circular photo-tube array (possibly television)."<sup>50</sup> Thus, either this very first report is describing a different craft than that described in the "White Hot Intelligence Estimate," or a very deliberate change has been made by the time of the latter's composition, which does not mention a "photo-tube array" at all, but stresses rather the complete lack of any such conventional technologies such as vacuum tubes.<sup>51</sup>

49 Ibid.

50 Ibid.

51 It should be noted, however, that the White Hot Intelligence Estimate stresses this lack in connection with the propulsion system, and not the control system, of the craft. It does mention television as a possibility for visual control and coordination of the craft, yet fails to mention the "photo-tube array" of the Air Accident Report.

That von Braun and von Karman are clearly thinking along cold fusion lines is evident from the fact that a mere plastic tube, much less the presumed heavy water within it, would have been blasted away in millionths of a second by the extreme heat present at the initiation of any hot fusion reaction.

And finally, the sixth point. In the "White Hot Intelligence Estimate," emphasis is placed on the lack of control features inside the craft. Yet, in the "Air Accident Report," a very conventional, very terrestrial set of "what resembles typewriter keys, possibly reactor/powerplant controls" were found.<sup>52</sup> These very terrestrial sounding "typewriter keys" are not the only piece of hardware that do not sound like ultra-advanced solid state ET technology, for perhaps the most perplexing aspect of the "Air Accident Report's" power plant description is the fact that the "ball-turret" component of the assembly was "encompassed by a series of gears that has an unusual ratio not known by any of our engineers."<sup>53</sup>

Gears!?!? Does this advanced ET heavy water doughnut cold fusion reactor with typewriter keys come with automatic, or just standard?

For the reader who has been paying attention, however, the description of the craft in the "Air Accident Report," as distinct from that in the "White Hot Intelligence Estimate," sounds very similar to descriptions of the various advanced technologies the Nazis were trying to perfect. And the clincher is the "bladeless turbine," that was apparently under development at the Air Materials Command and in the *Mogul Project*.<sup>54</sup> **Viktor Schauberger's** "*Repulsine*" saucer, developed for the Nazis, involved just such a bladeless turbine.

Taken on its own then, the "Air Accident Report" has little in it to suggest an extraterrestrial explanation, and a great deal in it that sounds all too uncomfortably like the secret research of the Kammlerstab. Notably, once again one senses that "conventional" though still highly advanced technologies were not the most unusual feature of the craft to catch the

investigators' attention. The unusual aspect that commanded it was rather their unusual and sophisticated combination: doughnut heavy water fusion reactors with gears and ball-turrets.

52 Ibid.

53 Ibid.

54 Ibid.

Taken together, these two documents begin to suggest that a "story" is beginning to take shape in the secret counsels of what will become the Majic-12 group.

First, the *German Paperclip scientists* were brought in, most likely because something about the craft - this very same feature of unusual combinations of technologies - suggested to the high American brass a very terrestrial, very German, origin. Second, while the technologies and their unusual combinations of them suggested by these two documents are not sufficiently advanced to argue persuasively for the ET explanation, they are sufficiently advanced enough to conclude that they constituted a significant national security threat and issue.

Somebody, somewhere, must have appeared to the high American brass-in-the-know, and we can only assume that General Twining was one such general officer, that someone somewhere was continuing, independently, the lines of research begun by the Kammlerstab. This required in turn a new intelligence and research-development agency with the highest security classification and direct responsibility to the President.

In short, there was an independently surviving Nazi research black project, and if the Roswell crashed vehicle(s) gave sufficient evidence of this fact, then the shock waves this must have sent through the corridors of power in the Pentagon must have been unimaginable. All the better then to cloak the sensational discovery in a multi-layered disinformation operation, to conceal it, as Nick Cook suggested, behind the ET Myth.

But there is another hypothesis that is also suggested by the "*White Hot Intelligence Estimate*", and that is that very possibly the truth was a combination of the two, that the first crash and recovery took place in Europe, and became the basis of a massive and very secret Nazi black projects effort to back engineer it. As we shall see at the end of this chapter, there is surprising confirmation of this idea from a little suspected source, a source often overlooked in histories of the Second World War and its rapid technological advancements. We will return to further development of this scenario in connection with the Nazi UFO Legend after we have examined the third document dealing with the technological aspects of the Roswell incident.

### **3. The Fall 1952 Majestic Twelve Project First Annual Report:**

This report should be viewed in conjunction with the two reports just examined, for it is the considered and calm review, now some five years from the event, of the highest levels of the agency established as a result of the Roswell Incident. As such, its descriptions of the recovered technology are of crucial significance, for by comparison one can ascertain the progress, or lack thereof, made in the intervening years in analyzing the recovered technologies. Moreover, one can analyze the progress, or lack thereof, of the ET interpretation first tentatively suggested in the "*White Hot Intelligence Estimate*."

At the outset, The "First Annual Report" clearly rules out a terrestrial explanation almost from the very beginning of the document: "All efforts have been made to identify the country or private concern (which) could have the technical and financial resources necessary to produce such a long-range flight. So far, no country on this earth has the means and the security of its resources to produce such."<sup>55</sup> The chronological progression of the ET hypothesis, from no mention in the "Air Accident Report," to an initially tentative and later stronger mention in the "White Hot Intelligence Estimate," has now ended with the ET hypothesis alone being the considered view of the group.

55 Ibid., p. 106.

The signal question to be addressed in the examination of this document is whether or not the evidence it cites sufficiently supports and compels to that conclusion. Or does it too fall into the pattern of internal conflicts of data-sets evidenced in the "*White Hot Intelligence Estimate*," presenting evidence that may have more terrestrial, and for that very reason, more sensational and extraordinary implications?



Preceding to the first piece of evidence advanced in favor of its chosen extraterrestrial explanation, the "First Annual Report" like the "White Hot Intelligence Estimate" before it clearly indicates that the recovered bodies are the strongest evidence in favor of that explanation:

"The occupants of these pan-form vehicles are, in most respects, human or human-like. Autopsies, so far indicate, that these being share the same biological needs as humans."<sup>56</sup>

It is to be noted that this is the first piece of evidence presented in the document, and thus to the MJ-12 group, it has already eclipsed in importance the significant technological recoveries.

But then in the very next section, two rather disturbing pieces of information are presented in very succinct fashion, without undo fanfare or preparation in the body of the document preceding them: "MAJESTIC SS&P," we are informed, "are currently focused on Psy-Op development for Cold War (counter-intelligence) activities."<sup>57</sup> Then in the very next sentence comes a stunning admission:

"Utilization of Paperclip specialists has yielded valuable results in new weapons research in areas of flight dynamics, biological and chemical agents, mind control, and intelligence gathering techniques."<sup>58</sup>

Ponder what has now been admitted: Majestic-12, allegedly established as a super-secret research, development, and intelligence agency, is already engaged - almost Ahnenerbe style - in psychological operations, employing Nazi scientists and "specialists" in new weapons development, including "mind control" and "intelligence gathering techniques."

- What has any of this to do with back-engineering alien flying saucers (whether terrestrial or extraterrestrial), unless a *psychological warfare operation* was considered to be essential for counter-intelligence purposes?
- Was the "ET" explanation being advanced as an integral component of that operation?

The beginning of this agenda was already beginning to make its presence felt as early as the "White Hot Intelligence Estimate," but there is not the slightest hint of it in the "Air Accident Report."<sup>59</sup>

<sup>56</sup> Ibid., p. 106.

<sup>57</sup> Ibid., p. 107.

<sup>58</sup> Ibid.

<sup>59</sup> And now another curious feature should be evident. The "Air Accident Report" nowhere mentions any recovered bodies, extraterrestrial or otherwise, certainly a curious omission if in fact there were such bodies present at one of the crash sites. Or was the problem simply that they were the wrong kind of bodies?

A lengthy section of the document then follows outlining in detail the various areas for long-range technological exploitation and development, ranging provocatively enough from "retro-viruses" and other biological warfare and pharmaceutical development, to miniaturization of "atomic bomb components" and "aircraft and missile design," to "new machining techniques... for high-temperature alloys and titanium" for "space exploration and hypersonic dynamics."<sup>60</sup>

Clearly by the time of this "First Annual Report" a great deal of research has already been done. But the resemblance with the broad mission brief and portfolio of Kammler's think tank is readily apparent, doubtless because of the presence of the Paperclip "specialists" within the organization, for in five short years, what began as a "modest" back-engineering and technology recovery black project has ballooned into a mega- bureaucracy coordinating almost all broad areas of American black projects secret weapons research.

Minus the death camps, of course, Majic-12 is almost the mirror image of the *Kammlerstab*. Is it the presence of Nazis, working in the deepest recesses of these black projects, that explains the US military's experimentation on Black American and other minority US citizens and soldiers, groups that such Nazis considered to be racially inferior? It is a profound moral question that cannot be pondered too long.

In any case, the document indicates that the propulsion technology of the craft is a major focus of effort:

The AEC and NEPA are currently conducting research for advanced technologies in atomic engines and radical propulsion studies. Systems studies at Los Alamos, N.M., Aak Ridge, Tenn., and at Langley, Va., are attempting to duplicate the water drive and plastic core elements found on the engine being kept at HAFB. Integration of hydrogen base fuels and electro-hydrodynamic technology, may open up for us development of super-aerodynes with mach 5 capabilities.<sup>61</sup>

60 Ibid., pp. 108-109.

61 Ibid., p. 110, f J.

The document then notes that the intention of the "visitors" does not appear to be conquest, since it would be easily within "their" capabilities if "they" chose to do so.<sup>62</sup>

Placing the whole project and its associated agencies at a level of classification higher than "that of the H-Bomb development,"<sup>63</sup> The "First Annual Report" then provides a rationale for its policy of strict denial of Roswell and similar types of events, predicting collapse of cultural confidence in familiar institutions such as science and religion.<sup>64</sup> So far, so good for the ET explanation.

62 Ibid., par. K.

63 Ibid., par. L.

64 Ibid., par. H.

But then at this juncture the technological "Annexes" are appended, the first of which, Annex A, contains information on the recovered craft and their occupants.

The Panel's review of the AEC and AFSWP investigation of Site L-1 and the Air Force Site L-2, has led the Panel to conclude that the objects under study, are the result of a high altitude ejection of a escape (sic) cylinder from a fatal mid-air collision of two unidentified circular platform aircraft of interplanetary nature.

Of particular interest to the Panel was site L-2, located at Lat 33-40-31, Long 106-28-29, as this site yielded the most material for analysis.

Site L-2 may be closely associated with Site L-1, and debris pattern suggests that the craft hit the ground at a sharp angle and continued to remain airborne until coming to rest at site L-2.

The craft found at Site L-2, is either the remains of a rocket-plane, or a powered glider. What remained of the power plant was examined and determined to be of a magnetic drive propulsion powered by a fusion reactor of sorts.

Lack of wiring, fuel systems, cables, motors, hydraulics, intakes, exhaust, and surface controls, strongly suggests that the craft was designed to travel outside of our atmosphere.

The second craft that impacted at Site L-3, provided very little evidence that it too was similar in design, as the impact was vertical in nature and at very high speed. It is believed that the debris discovered on 2 July 1947, by a local rancher was the result of a mid-air collision with an X-plane from HAFB; another unidentified object; or possibly collided with both. Radar film and tower logs do not explain the merging three radar targets prior to collision and subsequent crashes.

There were - five recovered bodies, two of which were found in a severely damaged escape cylinder, and the remaining three were found some distance away from the cylinder. All five appeared to have suffered from sudden decompression and heat suffocation (recovery and autopsies of the occupants are covered in detail in a separate study GRAY SUIT within Projects 612 and 621, ULATT EXPLOITATION-MAJESTIC SERIES 4, P. 40-102), as a result of damage sustained from unknown causes.

The Panel was concerned over the contamination of several SED personnel upon coming in contact with debris near the power plant. One technician was overcome and collapsed (sic) when he attempted the removal of a body. Another medical technician went into a coma four hours after placing a body in a rubber body-bag. All four were rushed to Los Alamos for observation. All four later died of seizures and profuse bleeding. All four were wearing protective suits when they came into contact with body fluids from the occupants.

Autopsies on the four dead SED technicians are not conclusive. It is believed that the four may have suffered from some form of toxin or a highly contagious disease. Tissue samples are currently being kept at Fort Detrick, Md.

The panel was also concerned with the detection of air-borne monitor flights over the Site L-2. Radiation readings indicate a high neutron count was recorded as the plane flew over the site. Neutron count dropped off as the plane flew a considerable distance from the site. A report has been filed with the USAIDS.

Detection of a high altitude explosion was recorded by a Project MOGUL constant level balloon on 4 July 1947. Radar from White Sands Proving Ground and HAFB also detected a surge.

Parachute recovery team from HAFB were dispatched to Site L-2. Upon arrival, the team, realizing the nature of the crash, radioed instructions and marked the crash site for the investigators that arrived later.

In the opinion of the senior AEC medical officer, current medical equipment and supplies are wholly inadequate in dealing with a large scale outbreak of alien virus.

Facilities at Los Alamos and Mayo clinics were considered as lacking in the current climate.

On 26 September 1947, the first meeting of the NSC-1 was held to discuss the New Mexico incidents and how to implement the policy established by MJ-12 SS&P.<sup>65</sup>

What emerges from this annex is actually very little new technical data, but the lingering sense of ambiguity that hovered over the "White Hot Intelligence Estimate" is resolved by the new information that there were two, possibly more, craft involved, one of which was a powered "glider".<sup>66</sup>

**65 Ibid., pp. 112-113, emphasis added.**

**66 It should be noted, however, that the clear implication of the language of the "Air Accident Report," and even more of the "White Hot Intelligence Estimate," is that there are more than one crash site, therefore strong suggesting more than one crashed vehicle.**

Note again that the strongest evidence presented for the extraterrestrial hypothesis in the document is the recovery of bodies and their apparently quite toxic effects on humans. This scenario is not far-fetched, for similar results attended the first contact between Europeans and American Indians, whose respective systems had built up different immunities.

Finally, note the strange transformation of Project MOGUL from a program apparently initially involving bladeless turbines, to a project involving the launching of constant altitude balloons to monitor Soviet nuclear tests!

So what can one make of all three documents together? As we have already observed, there is a curious progression, from the initial "Air Accident Report", in which an extraterrestrial explanation is not even mentioned, to the "White Hot Intelligence Estimate," in which both options are left open initially, but in which the ET hypothesis becomes the privileged model of interpretation, to the "First Annual Report", where only the ET hypothesis is seriously entertained.

This highlights a possible scenario of what happened.

Let us first consider what happened at the Roswell incident along the ET paradigm. This paradigm and interpretation have gained such status within the UFO community that, extraordinary as it is, it now seems almost commonplace. Unusual debris of some strange material is discovered by a local rancher in a field. Bodies are found and autopsied. They are small and human-like and cause the deaths of some of the medical personnel who first handled them.

A propulsion unit is found that is highly advanced. The story goes out on the newspaper wire: the army has recovered a crashed flying saucer, while at the same time General Twining is issuing his "Air Accident Report" in which no mention is made of the ET hypothesis at all. Witnesses are interviewed and the public reaches a conclusion: We have been visited by ET. And this is indeed a plausible scenario that fits some of the facts alleged in the reports on the incident.

But there are considerable technological problems with this interpretation. If the crashed vehicles were even suspected of being of ET origin, then why call in the German Paperclip scientists, and then keep them in the loop long after the ET hypothesis has become the official though top secret explanation? It is far more likely that they were consulted because some at a very high level in the US military had seen this technology before. In fact, if it was German saucer or some later development that crashed in New Mexico, if the "leaf book" mentioned by the "White Hot Intelligence Estimate" was "alien" in the sense of foreign but terrestrial, then the military's alarm becomes paradoxically more understandable.

In 1947 the war was already two years over. Yet, here was a crashed vehicle with all the signatures one came to recognize from Kammler's advanced research projects. Where did it come from? A cover-up on this view would have been as necessary, if not much more so, from the military's point of view as on the view that it was a crashed ET vehicle. In this event, the strangeness of the recovered technology would have suggested a plausible foundation for a deep layer of disinformation planted in the reports themselves, to be disseminated when weather balloons and monkey bodies were no longer capable of holding back the ET flood. There would have been no records of such an understanding,<sup>67</sup> it would have been arrived at in oral discussions, and "worked into" the otherwise reliable information contained in its classified reports.

67 In this respect, consider carefully the statements of Colonel Corso in the epigrams that began this chapter.

In this respect, it is perhaps significant that some contemporary observers of the American space program and its odd thirty-year long "holding pattern" and tapestry of inconsistencies, lies, and obfuscations have long suspected that there are indeed two space programs inside the US government, the "public NASA one, and a quasi-independent one based deep within covert and black projects.

In 1970, a curious document based upon the *Garrison Investigation's* voluminous files, called the "[Nomenclature of an Assassination Cabal](#)", otherwise known as *the Torbitt document*, was circulated, alleging a connection between this secret space program and the murder of President [John F. Kennedy](#). Radio talk show conspiracy theorist **Mae Brussel** concurred: the secret space program was being run inside and quasi-independently of the public [NASA program](#), and both were being coordinated by **Wernher von Braun**.

In this connection it is perhaps informative that the last document in the Cantwheel Majestic-12 documents is a Top Secret memo from November 12, 1963, - a scant ten days before the assassination - from President [Kennedy](#) to the Director of Counter Intelligence of the Central Intelligence Agency:

SUBJECT: Classification review of all UFO intelligence files affecting National Security. As I had discussed with you previously, I have initiated ????????? and have instructed **James Webb** to develop a program with the Soviet Union in joint space and lunar exploration. It would be very helpful if you would have the high threat cases reviewed with the purpose of identification of bona fide as opposed to classified CIA and USAF sources.

It is important that we make a clear distinction between the *knowns* and the *unknowns* in the event the Soviets try to mistake our extended cooperation as a cover for intelligence gathering of their defense and space programs. When this data has been sorted out, I would like you to arrange a program of data sharing with [NASA](#) where *Unknowns* are a factor. This will help NASA mission directors in their defensive responsibilities. I would like an interim report on the data review no later than February 1, 1964.

/s/ John F. Kennedy.<sup>68</sup>

68 *Ibid.*, p. 190.

A program of joint space and lunar exploration with the Soviet Union would clearly have placed Kennedy at cross-purposes with [Lyndon Johnson](#) and others who viewed the space program as the next great military development and arms race, control of which would assure earth dominance. Such a declassification review and potential release of data would also have brought Kennedy into sharp conflict and cross-purposes with the **Majic-12 Group** in general, and its Paperclip "specialists" in particular, who viewed space almost exclusively as a military venture.

## D. Russians, Terrorists, Asteroids and Aliens: The Rosin Affidavit

But perhaps the most chilling and corroborative bit of evidence of a secret space program and agenda was left by **Wernher von Braun** himself. [Dr. Carol Rosin](#), a close associate of the former Nazi cum-NASA director and the first woman corporate manager of *Fairchild Industries*, gave an affidavit to [Dr. Steven Greer's](#) "Disclosure Project" in the Spring of 2001.

[Rosin](#) recounts something that she alleges [von Braun](#) repeatedly told her:

What was most interesting to me was a repetitive sentence that he said to me over and over again during the approximately four years that I had the opportunity to work with him. He said the strategy that was being used to educate the public and decision makers was to use scare tactics.... That was how we identify an enemy.

The strategy that Werner von Braun taught me was that first the Russians are going to be considered the enemy....

Then terrorists would be identified, and that was soon to follow... Then we were going to identify third-world country "crazies". We now call them Nations of concern. But he said that would be the third enemy against whom we would build space-bead weapons.

The next enemy was asteroids. Now, at this point he kind of chuckled the first time he said it. Asteroids -against asteroids we are going to build space-based weapons.<sup>69</sup>

69 Implying, incidentally, an immense destructive power -a one-shot planet-busting capacity - for such weapons, for such power they would have to possess to be of any use against an asteroid large enough to destroy the earth, or large enough to threaten all life on it.

And the funniest one of all was what he called aliens, extraterrestrials. That would be the final scare. And over and over during the four years that I knew him and was giving speeches for him, he would bring up that last card. "And remember Carol, the last card is the alien card. We are going to have to build space-based weapons against aliens and all of it is a lie."<sup>70</sup>

70 Steven M, Greer, M.D., *Disclosure: Military and Government Witnesses reveal the Greatest Secrets in Modern History* (Crozer, Virginia: 2001), pp. 255-256.

## **Russians, Terrorists. Crazy Third World Dictators. Asteroids. Aliens.**

It is significant that President **George W. Bush**, shortly after his inauguration, made the Army's chief of space operations the Chairman of the Joint Chiefs of Staff, signaling the first time in history a military space commander has headed such a combined staff position. It is also significant too that almost immediately thereafter missile defense - *Ronald Reagan's old Strategic Defense Initiative* - once again became a high military and national security priority.

And it is perhaps the most significant of all that [the tragic events of September 11, 2001](#), marked the transition from *Russians* to *Terrorists*, as the official enemy of choice, and then, with the invasions of Afghanistan and Iraq, almost immediately to *Dictators of "Nations of Concern."*

## **E. An Unlikely Source: Benito Mussolini's Secret RS/33 UFO- Marconi Study Group: The Original Italian "MJ-12" Documents**

But how could Dr. **Wernher von Braun**, Paperclip rocket "specialist", speaking in the early 1970s, be so exactly prescient in his prediction of the exact sequence of "enemies"? One answer, that of [the "Torbutt" document](#), is of course that he himself was a senior "insider", privy to the plots and canards of the innermost conspiracies driving western politics and culture.

However, another source of material has emerged only recently that might afford a clue as to how long UFOs have been being secretly studied and attempts made to back engineer them for some time. In the year 2000, very secret papers from the archives of the Italian government were deliberately leaked to Italian UFOlogists. Unlike the **MJ-12** documents, however, these documents were not films, nor photocopies, but the actual handwritten notes and original files and telegrams, on original paper, with original ink. This allowed documents experts from the University of Bologna to do an exhaustive analysis of the paper and inks and style of writing of the telegrams. The conclusion? The documents were undoubtedly authentic.

The story they contained was nothing less than explosive, for they told how, in response to various UFO sightings in the north of Fascist Italy in 1933, and Italian Air Force scrambles to intercept the intruders, that Benito Mussolini had established the first state level black projects UFO study group, under the direction of the famous Italian physicist and inventor Marconi.

The group, like a much later American project, assembles reports, photographs, witness testimonies, and developed a classification system for various types of sightings. The group was classified at the highest level by Mussolini. When Fascist Italy and Nazi Germany concluded the Rome-Berlin Axis, Mussolini transferred, often literally shipping this treasure trove of information to Nazi Germany, where it most likely made its way eventually into the hands of the SS.

In any case, On February 23, 1941, as the war clouds between the Axis and the United States were growing darker, Mussolini made one of his characteristically blunt statements. He said,

"It's far more likely that the United States will be invaded by unknown but warlike inhabitants from the planet Mars, who will come down from the starry space on unimaginable flying fortresses, than from the soldiers of the Axis."

A strange statement indeed, even for a man who excelled in making unpredictable pronouncements.

What does all this suggest? First, that at the deepest level, a profoundly advanced terrestrial rather than extraterrestrial technology was behind at least some of the facts associated with Roswell. This technology and its use in unusual combinations points quite clearly to Germany. Second, it means that at a level still deep, but less so, there is an extraterrestrial aspect that may be part of a disinformation operation and deep-cover story, or that may have entered the picture nearly a decade and a half before Roswell.

In any case, in the light of the fact that as more and more documents are leaked, released, or declassified from the World War 2 era, perhaps the most significant lesson to be learned is that one should perhaps be more cautious in ascribing an "ET" origin to such events and sightings without first having considered the terrestrial alternatives, no matter how disquieting those alternatives maybe.



22 agosto XIV

Come Velletri,  
ho sempre pensato che questo era  
Velletri: anche che ho la Prefettura  
di Tarquinia che abbiamo, la suddivisione  
indagini, non c'è nulla di lì ma anche  
storia della nostra misfazione!! ---  
Fu avvertita nella mattina (o sera) della

una persona con 14 palloni che ho  
lun più volte di cui ho parlato  
che è stato veduto da altri gente.  
D'ora in poi, anche da quel Mares-  
melli che ha visto il oggetto che  
è arrivato a mano di Lione.  
Poi, da una persona a cui dopo di  
già ho una grande zona Mares-  
i visto con la gente ancora fa bene  
la) una volta di lungo fido molto  
due, grigio o antracite. Nel rapporto  
del oggetto / A è un oggetto



Probabilmente un proiettile di stoppione.  
Ma per altre ipotesi che non sono  
per un oggetto molto pesante e in  
già a grandi velocità. In un caso  
i miei: fu visto che per lungo  
ho parlato dei rapporti di

in rapporto con un altro oggetto e un  
proprietà. Ma come sono di lì  
altro volte e di lì di grande di  
ho ho detto che in un caso  
altro: è stato di grande effetto  
proprietà che sono nel caso.

Adesso



adossato alla n. 75.30 viale M.F.



oggetto simile a  
Turchese

1944 1944

Indirizzo di origine  
 TELEGRAMMA

UFFICIO TELEGRAFICO DI MILANO  
 TELEGRAMMA

Numero di arrivo di una tele-  
 grammata

15-5

17-5

19-5

21-5

23-5

25-5

27-5

29-5

31-5

1-6

3-6

5-6

7-6

9-6

11-6

13-6

15-6

17-6

19-6

21-6

23-6

25-6

27-6

29-6

31-6

1-7

3-7

5-7

7-7

9-7

11-7

13-7

15-7

17-7

19-7

21-7

23-7

25-7

27-7

29-7

31-7

1-8

3-8

5-8

7-8

9-8

11-8

13-8

15-8

17-8

19-8

21-8

23-8

25-8

27-8

29-8

31-8

1-9

3-9

5-9

7-9

9-9

11-9

13-9

15-9

17-9

19-9

21-9

23-9

25-9

27-9

29-9

31-9

1-10

3-10

5-10

7-10

9-10

11-10

13-10

15-10

17-10

19-10

21-10

23-10

25-10

27-10

29-10

31-10

1-11

3-11

5-11

7-11

9-11

11-11

13-11

15-11

17-11

19-11

21-11

23-11

25-11

27-11

29-11

31-11

1-12

3-12

5-12

7-12

9-12

11-12

13-12

15-12

17-12

19-12

21-12

23-12

25-12

27-12

29-12

31-12

1-13

3-13

5-13

7-13

9-13

11-13

13-13

15-13

17-13

19-13

21-13

23-13

25-13

27-13

29-13

31-13

1-14

3-14

5-14

7-14

9-14

11-14

13-14

15-14

17-14

19-14

21-14

23-14

25-14

27-14

29-14

31-14

1-15

3-15

5-15

7-15

9-15

11-15

13-15

15-15

17-15

19-15

21-15

23-15

25-15

27-15

29-15

31-15

1-16

3-16

5-16

7-16

9-16

11-16

13-16

15-16

17-16

19-16

21-16

23-16

25-16

27-16

29-16

31-16

1-17

3-17

5-17

7-17

9-17

11-17

13-17

15-17

17-17

19-17

21-17

23-17

25-17

27-17

29-17

31-17

1-18

3-18

5-18

7-18

9-18

11-18

13-18

15-18

17-18

19-18

21-18

23-18

25-18

27-18

29-18

31-18

1-19

3-19

5-19

7-19

9-19

11-19

13-19

15-19

17-19

19-19

21-19

23-19

25-19

27-19

29-19

31-19

1-20

3-20

5-20

7-20

9-20

11-20

13-20

15-20

17-20

19-20

21-20

23-20

25-20

27-20

29-20

31-20

1-21

3-21

5-21

7-21

9-21

11-21

13-21

15-21

17-21

19-21

21-21

23-21

25-21

27-21

29-21

31-21

1-22

3-22

5-22

7-22

9-22

11-22

13-22

15-22

17-22

19-22

21-22

23-22

25-22

27-22

29-22

31-22

1-23

3-23

5-23

7-23

9-23

11-23

13-23

15-23

17-23

19-23

21-23

23-23

25-23

27-23

29-23

31-23

1-24

3-24

5-24

7-24

9-24

11-24

13-24

15-24

17-24

19-24

21-24

23-24

25-24

27-24

29-24

31-24

1-25

3-25

5-25

7-25

9-25

11-25

13-25

15-25

17-25

19-25

21-25

23-25

25-25

27-25

29-25

31-25

1-26

3-26

5-26

7-26

9-26

11-26

13-26

15-26

17-26

19-26

21-26

23-26

25-26

27-26

29-26

31-26

1-27

3-27

5-27

7-27

9-27

11-27

13-27

15-27

17-27

19-27

21-27

23-27

25-27

27-27

29-27

31-27

1-28

3-28

5-28

7-28

9-28

11-28

13-28

15-28

17-28

19-28

21-28

23-28

25-28

27-28

29-28

31-28

1-29

3-29

5-29

7-29

9-29

11-29

13-29

15-29

17-29

19-29

21-29

23-29

25-29

27-29

29-29

31-29

1-30

3-30

5-30

7-30

9-30

11-30

13-30

15-30

17-30

19-30

21-30

23-30

25-30

27-30

29-30

31-30

1-31

3-31

5-31

7-31

9-31

11-31

13-31

15-31

17-31

19-31

21-31

23-31

25-31

27-31

29-31

31-31

1-32

3-32

5-32

7-32

9-32

11-32

13-32

15-32

17-32

19-32

21-32

23-32

25-32

27-32

29-32

31-32

1-33

3-33

5-33

7-33

9-33

11-33

13-33

15-33

17-33

19-33

21-33

23-33

25-33

27-33

29-33

31-33

1-34

3-34

5-34

7-34

9-34

11-34

13-34

15-34

17-34

19-34

21-34

23-34

25-34

27-34

29-34

31-34

1-35

3-35

5-35

7-35

9-35

11-35

13-35

15-35

17-35

19-35

21-35

23-35

25-35

27-35

29-35

31-35

1-36

3-36

5-36

7-36

9-36

11-36

13-36

15-36

17-36

19-36

21-36

23-36

25-36

27-36

29-36

31-36

1-37

3-37

5-37

7-37

9-37

11-37

13-37

15-37

17-37

19-37

21-37

23-37

25-37

27-37

29-37

31-37

1-38

3-38

5-38

7-38

9-38

11-38

13-38

15-38

17-38

19-38

21-38

23-38

25-38

27-38

29-38

31-38

1-39

3-39

5-39

7-39

9-39

11-39

13-39

15-39

17-39

19-39

21-39

23-39

25-39

27-39

29-39

31-39

1-40

3-40

5-40

7-40

9-40

11-40

13-40

15-40

17-40

19-40

21-40

23-40

25-40

27-40

29-40

31-40

1-41

3-41

5-41

7-41

9-41

11-41

13-41

15-41

17-41

19-41

21-41

23-41

25-41

27-41

29-41

31-41

1-42

3-42

5-42

7-42

9-42

11-42

13-42

15-42

17-42

19-42

21-42

23-42

25-42

27-42

29-42

31-42

1-43

3-43

5-43

7-43

9-43

11-43

13-43

15-43

17-43

19-43

21-43

23-43

25-43

27-43

29-43

31-43

1-44

3-44

5-44

7-44

9-44

11-44

13-44

15-44

17-44

19-44

21-44

23-44

25-44

27-44

29-44

31-44

1-45

3-45

5-45

7-45

9-45

11-45

13-45

15-45

17-45

19-45

21-45

23-45

25-45

27-45

29-45

31-45

1-46

3-46

5-46

7-46

9-46

11-46

13-46

15-46

17-46

19-46

21-46

23-46

25-46

27-46

29-46

31-46

1-47

3-47

5-47

7-47

9-47

11-47

13-47

15-47

17-47

19-47

21-47

23-47

25-47

27-47

29-47

31-47

1-48

3-48

5-48

7-48

9-48

11-48

13-48

15-48

17-48

19-48

21-48

23-48

25-48

27-48

29-48

31-48

1-49

3-49

5-49

7-49

9-49

11-49

13-49

15-49

17-49

19-49

21-49

23-49

25-49

27-49

29-49

31-49

1-50

3-50

5-50

7-50

9-50

11-50

13-50

15-50

17-50

19-50

21-50

23-50

25-50

27-50

29-50

31-50

1-51

3-51

5-51

7-51

9-51

11-51

13-51

15-51

17-51

19-51

21-51

23-51

25-51

27-51

29-51

31-51

1-52

3-52

5-52

7-52

9-52

11-52

13-52

15-52

17-52

19-52

21-52

23-52

25-52

27-52

29-52

31-52

1-53

3-53

5-53

7-53

9-53

11-53

13-53

15-53

17-53

19-53

21-53

23-53

25-53

27-53

29-53

31-53

1-54

3-54

5-54

7-54

9-54

11-54

13-54

15-54

17-54

19-54

21-54

23-54

25-54

27-54

29-54

31-54

1-55

3-55

5-55

7-55

9-55

11-55

13-55

15-55

17-55

19-55

21-55

23-55

25-55

27-55

29-55

31-55

1-56

3-56

5-56

7-56

9-56

11-56

13-56

15-56

17-56

19-56

21-56

23-56

25-56

27-56

29-56

31-56

1-57

3-57

5-57

7-57

9-57

11-57

13-57

15-57

17-57

19-57

21-57

23-57

25-57

27-57

29-57

31-57

1-58

3-58

5-58

7-58

9-58

11-58

13-58

15-58

17-58

19-58

21-58

23-58

25-58

27-58

29-58

31-58

1-59

3-59

5-59

7-59

9-59

11-59

13-59

15-59

17-59

19-59

21-59

23-59

25-59

27-59

29-59

31-59

1-60

3-60

5-60

7-60

9-60

11-60

13-60

15-60

17-60

19-60

21-60

23-60

25-60

27-60

29-60

31-60

1-61

3-61

5-61

7-61

9-61

11-61

13-61

15-61

17-61

19-61

21-61

23-61

25-61

27-61

29-61

31-61

1-62

3-62

5-62

7-62

9-62

11-62

13-62

15-62

17-62

19-62

21-62

23-62

25-62

27-62

29-62

31-62

1-63

3-63

5-63

7-63

9-63

11-63

13-63

15-63

17-63

19-63

21-63

23-63

25-63

27-63

29-63

31-63

1-64

3-64

5-64

7-64

9-64

11-64

13-64

15-64

17-64

19-64

21-64

23-64

25-64

27-64

29-64

31-64

1-65

3-65

5-65

7-65

9-65

11-65

13-65

15-65

17-65

19-65

21-65

23-65

25-65

27-65

29-65

31-65

1-66

3-66

5-66

7-66

9-66

11-66

13-66

15-66

17-66

19-66

21-66

23-66

25-66

27-66

29-66

31-66

1-67

3-67

5-67

7-67

9-67

11-67

13-67

15-67

17-67

19-67

21-67

23-67

25-67

27-67

29-67

31-67

1-68

3-68

5-68

7-68

9-68

11-68

13-68

15-68

17-68

19-68

21-68

23-68

25-68

27-68

29-68

31-68

1-69

3-69

5-69

7-69

9-69

11-69

13-69

15-69

17-69

19-69

21-69

23-69

25-69

27-69

29-69

31-69

1-70

3-70

5-70

7-70

9-70

11-70

13-70

15-70

17-70

19-70

21-70

23-70

25-70

27-70

29-70

31-70

1-71

3-71

5-71

7-71

9-71

11-71

13-71

15-71

17-71

19-71

21-71

23-71

25-71

27-71

29-71

31-71

1-72

3-72

5-72

7-72

9-72

11-72

13-72

15-72

17-72

19-72

21-72

23-72

25-72

27-72

29-72

31-72

1-73

3-73

5-73

7-73

9-73

11-73

13-73

15-73

17-73

19-73

21-73

23-73

25-73

27-73

29-73

31-73

1-74

3-74

5-74

7-74

9-74

11-74

13-74

15-74

17-74

19-74

21-74

23-74

25-74

27-74

29-74

31-74

1-75

3-75

5-75

7-75

9-75

11-75

13-75

15-75

17-75

19-75

21-75

23-75

25-75

27-75

29-75

31-75

1-76

3-76

5-76

7-76

9-76

11-76

13-76

15-76

17-76

19-76

21-76

23-76

25-76

27-76

29-76

31-76

1-77

3-77

5-77

7-77

9-77

11-77

13-77

15-77

17-77

19-77

21-77</

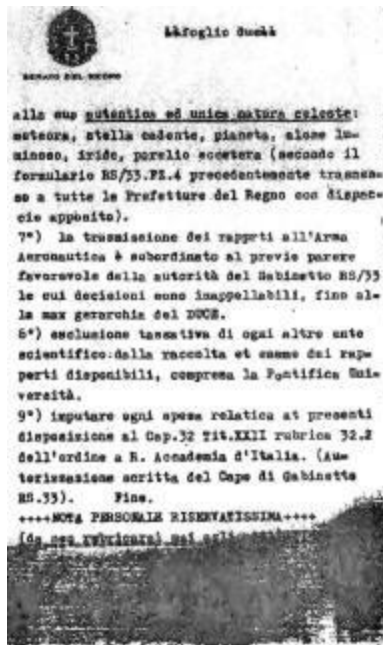

The Fascist Italian RS/33 Documents:  
Portions of a Memorandum

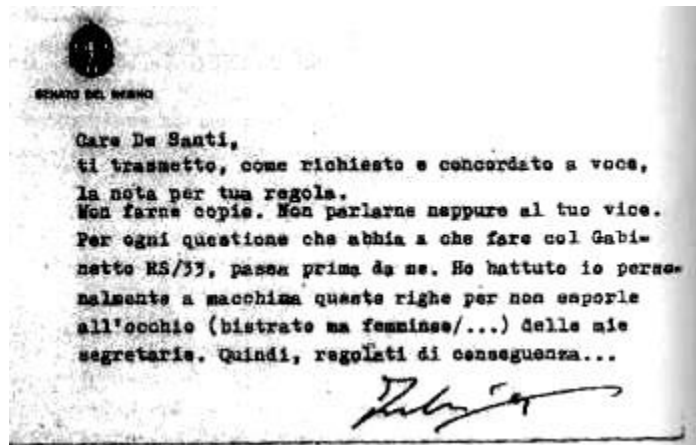
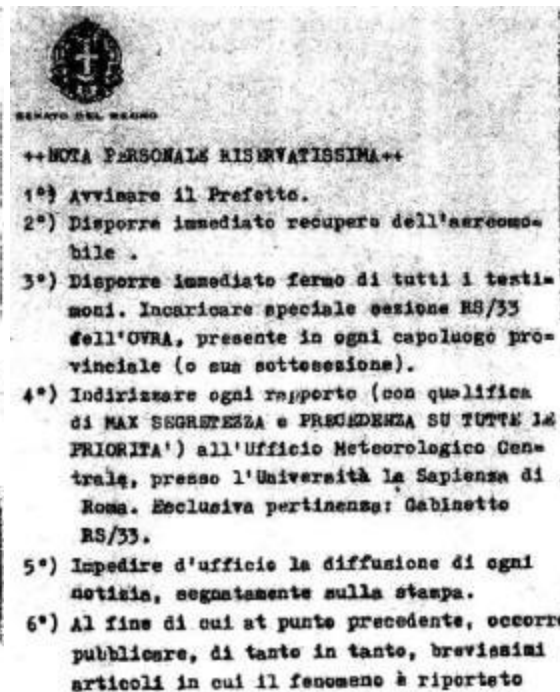

[Back to Contents](#)

[Back to The Saga of Flying Objects](#)

## Chapter 17: THE KECKSBURG ACORN RINGS THE BELL

"When you started on the path that you did, sooner or later the trail was going to lead you to Germany. "

**Nick Cook**

The Hunt for Zero Point <sup>1</sup>

"This is a story of how key Nazis.... anticipated military disaster and laid plans to transplant Nazism, intact but disguised, in havens in the West... "

**Mae Brussel**

Rebel Magazine <sup>2</sup>

<sup>1</sup> Nick Cook, The Hunt for Zero Point, p. 270.

<sup>2</sup> Cited in Jonathan Vankin, Conspiracies, Crimes, and Cover-ups, p. 104.

### A. The "Bell"



The most sensational piece of information on Nazi secret research to come out since the reunification of Germany - indeed, since the origins of the Nazi "UFO" Legend itself- is the story told by **Nick Cook** in his *Quest for Zero Point*, which appeared in the U.K. in 2001. The story is, additionally, the only real solid piece of corroboration of the Nazi UFO Legend to appear since the war, based, as it is, on a secret and recently declassified Polish war crimes trial affidavit of a former SS general.

"The Bell" (German: *die Glocke*) represented something at the very pinnacle of Kammler's grizzly and super-secret SS "wonderweapons" empire. Cook's book represents the only publicly accessible information on this bizarre object in the English language, the equally macabre experimentation that surrounded it, and the stringent security the SS held it under.

The following are the salient features of The Bell, according to **Cook**:

- (1) The Bell was reportedly a metallic object, approximately 9' in diameter and 12-15' tall;
- (2) It looked like a "Bell", hence its codename to the Germans, *die Glocke*;
- (3) It was comprised of two counter-rotating cylinders, rotating a purplish liquid-metallic looking substance code-named "Xerum 525" by the Germans, at high speeds;<sup>3</sup>
- (4) "Xerum 525" was apparently highly radioactive, being purple in color, and housed in cylinders with lead lining 3 cm thick;<sup>4</sup>
- (5) The Bell apparently required high amounts of electrical power in its operation;<sup>5</sup>
- (6) During use, it could only be run for approximately one to two minutes, as it apparently gave off strong radiation and/or other electromagnetic or unknown field effects;<sup>6</sup>
  - (a) Several scientist died on its first operation;<sup>7</sup>
  - (b) Subsequent tests included various plants and animals, all of which decomposed into a blackish goo and without normal putrefaction, within a matter of a few minutes or hours after exposure to its field effects when in operation;<sup>8</sup>
  - (c) Technicians near the Bell during these experiments reported metallic tastes in their mouths after being exposed to it;<sup>9</sup>
  - (d) The chamber in which the Bell was tested was lined with ceramic bricks and rubber mats, and had to have its rubber matting removed and burned after each test, and it was subsequently washed down with brine by inmates from nearby concentration camps;<sup>10</sup>
- (6) All the scientists and witnesses who saw or worked on the Bell were murdered by the SS as the war neared its end;<sup>11</sup>
- (7) The Hell was transplanted out of Silesia to a destination that has never been discovered. The Bell, along with General **Kammler** himself, simply disappear entirely from history, never to be seen again.
- (8) A strange "henge" like structure was constructed by the Germans out of reinforced concrete near the facility where the Bell was located and tested. This structure resembled a test rig for the possible test of extremely powerful propulsion devices.<sup>12</sup>

<sup>3</sup> Cook, *op. cit.*, p. 192.

<sup>4</sup> *Ibid.*

<sup>5</sup> *Ibid.*, pp. 182, 197

<sup>6</sup> *Ibid.*, pp. 192-193

<sup>7</sup> *Ibid.*, p. 193.

<sup>8</sup> *Ibid.*, p. 192.

<sup>9</sup> *Ibid.*, p. 193.

<sup>10</sup> *Ibid.*, p. 192.

<sup>11</sup> *Ibid.*, p. 184. It is due to the fact that the Bell's scientists were murdered that we know anything about it at all, for the chief executioner, SS General Sporrenburg, who was tasked by Kammler with the murders, gave the only known testimony and descriptions of the Bell in his affidavit to a post-war Polish war crimes trial, for which he was convicted and executed.

<sup>12</sup> Cook, *op. cit.*, pp. 197-198.

**Cook** also notes that, at the end of the war, **Kammler** had special jurisdiction over a secret "SS evacuation command" that had been personally established by Reichsleiter Martin Bormann in great secrecy. This command included jurisdiction over all of Nazi Germany's heavy-lift ultra-long range transport aircraft, including the Ju-290 and the six engine monster, the Ju-390, that we encountered in part one. These planes were based at the end of the war quite near the secret underground facility where the Bell was being tested.

Before proceeding, it would be useful to note a few things about this strange list of properties.

First, whatever the Bell was, Kammler's SS apparently thought its secrets were so valuable, that anyone connected with its construction and/or testing had to be executed at the end of the war to prevent these from being leaked, presumably to the Russians, since the Bell was located and tested in Silesia, in what would later become Poland and East Germany.

Second, we note again the use of concentration camp inmates to perform the dangerous, and one can only presume, eventually lethal, operation of cleaning the test chamber after each experimentation with the Bell. This fact places this mysterious object firmly within Kammler's SS secret weapons black projects empire. It is entirely possible that the Bell represented something so sophisticated in terms of its principles of operation, that the then existing technology could not offer a sufficient means of protection for the important personnel involved in the experiments. Hence, concentration camp inmates may have been used as fodder to enable the experiments to go forward. Any breakthroughs the Bell represented were thus accomplished by this means, at enormous human cost.

Finally, certain properties about the Bell should be noted, since they constitute unusual data points that will be examined in connection with the Kecksburg "UFO crash". These are:

- Heavy electrical power consumption
- Rotation of a radioactive liquid in two counter-rotating cylinders
- An unusual radioactive liquid metal of unknown composition
- Its location in a chamber lined with ceramic bricks and rubber mats

The rotation of the object, and presumably the radioactive liquid-metal called "Xerum 525", suggests that the Germans were investigating the inertial and vortex properties of radioactive material when subjected to high speed rotation, as well as the resulting field effects. It is likely that this rotation was caused by passing a current through the liquid - hence the high power consumption - but the possibility of mechanical rotation should not be ruled out in addition to this, as German progress in jet engine turbines and uranium centrifuges would have given them the experience to construct very high speed turbines for rotating such material for study.

In this sense, it is possible that the Bell was nothing more than two counter-rotating ultra-high speed turbines. That is to say, the Bell may have been an ultra high speed electro-mechanical turbine of some sort, an offshoot, perhaps, of German centrifuge technology development.

The housing of this device in an underground chamber lined with ceramic brick and rubber mats suggests that it gave off extremely strong electro-magnetic or electro-static field effects as well as high heat when in operation. The reporting of metallic tastes in the mouths of what few surviving personnel there are suggests this. The quick decay without apparent putrefaction of organic material within its field suggests effects that some would associate with scalar waves.

But what was the mysterious "Xerum 525"? When I first read of this strange material, I thought it might be some radioactive isotope of mercury, or possibly a more radioactive substance in chemical solution of some sort. It is perhaps worth noting that recently a strange substance known as "red mercury", or *mercury antimonate oxide*, has been alleged to have strong neutron emitting properties when subjected to sudden explosive stress, and is alleged to be a non-fissile method of triggering the enormous fusion reactions of hydrogen bombs, as well as being able, in its own right, of fission explosions in the small kiloton range. Perhaps the Nazis had stumbled onto a similar such substance during the war.

It was on the basis of certain features of the above lists of the Bell's properties that I hypothesized in my previous book, *The Giza Death Star Deployed*, that the object that crashed in the famous Kecksburg UFO crash retrieval case might have been the Bell itself. In that book, I did not explore that hypothesis, leaving it for "another book." Well, this is that "other book", and it is now necessary to examine the odd data points that seem to connect these two mysterious objects.

## **B. The UFO Crash and Retrieval at Kecksburg, Pennsylvania, December 1965**

Twenty years after Kammler's "Bell" went missing, a remarkably similar object reportedly crashed in Kecksburg, Pennsylvania, in a wooded area in the country. The story of the *Kecksburg incident* begins at approximately 4:45 PM, December 9, 1965. From northern Canada to western Pennsylvania, thousands of witnesses described "an orange fireball tearing across the evening sky towards the south east, followed by a trail of smoke."<sup>13</sup> Witnesses included pilots spread throughout Ontario, Michigan, and Ohio that were along the flight path of the object.

Once over Ohio, however, the object clearly demonstrated that it was not a typical meteor, nor a crash in the ordinary sense of "space debris," for according to witnesses, it stopped, stood still "for a few seconds" and then changed its course towards Pennsylvania.<sup>14</sup>

At this point, the Kecksburg saga begins in earnest, for at 4:47 PM, a Mrs. Jones called the local radio station WHJB in Greensburg and told reporter John Murphy that "a huge fireball has crashed in the woods about 1.5 miles from here."<sup>15</sup> Her children had been playing outside when they first saw it, describing it as a burning star. Mrs. Jones, visiting a neighbor at that time on then porch, saw blue smoke coming from the forest and a bright light hovering above the area.<sup>16</sup>

In the meantime, the reporter John Murphy had already driven to the site, finding already a beehive of activity there, with two police cruisers and a fire engine from the local volunteer fire-department parked at the wood's edge. After questioning Mrs. Jones and her children, the local fire marshal and one of the policemen walked into the forest, and reemerged sixteen minutes later. In response to reporter Murphy's questions, the fire marshal directed him to his lawyer!<sup>17</sup>

What followed over the next few hours was genuinely bizarre, as the US Army and Air Force, and apparently some NASA scientists and technicians,<sup>18</sup> literally moved in and placed the tiny village and its environs under virtual martial law:

Whatever it was that had crashed in the forest, the Army and Air Force marched up to deal with it. The military and state police cordoned off the forest area, stationed armed guards at all the roads and ways leading into the forest and transported a whole lot of equipment to the crash site. The Air Force took over the premises of the local voluntary fire station and set up a commando post there.

The firemen, now forbidden to enter the station, stood by watching while persons in military uniform brought in more equipment into the station, which included a huge radio transmitter. A little later, two large transport trucks, one of them bearing the insignia of the army, were seen driving into the forest. At about the same time, people living close to the nearby Latrobe Airfield saw a jet plane landing there, although the airfield itself had been closed to traffic for quite some time.<sup>19</sup>

14 Hesemann, *op. cit.*, p. 167.

15 *Ibid.*

16 *Ibid.*, p. 168.

17 *Ibid.*

18 Q.v. Stan Gordon, *Kecksburg: the Untold Story* (DVD video production. Gordon is considered the expert on the Kecksburg case, and the video consists of a series of recorded interviews with surviving witnesses to the event. According to Mrs. Lillian Hayes, wife of a local farmer, and her son both stated that their house was visited several times that night by military personnel, and she reports having overheard them discussing the fact that NASA was already on the scene.

19 Hesemann, *op. cit.*, p. 168.

Later, television, newspaper, and radio reporters arrived from Pittsburg, to be met with a wall of silence from the military.

But a police spokesman stated "there's an unidentified flying object in the woods." When the US Air Force's Project Blue book was contacted, Major Hector Quintanilla himself, then project head, informed the reporters that the Air Force's investigators were already at the site.<sup>20</sup>

If it were only for the official statements and peculiar "overreaction" of the military in such a quick response to the event, and in placing an entire town and considerable portion of its environs under virtual martial law and placing a secure perimeter around a Pennsylvania wood, little else would have been known of the Kecksburg crash. However, a local who had been listening to the radio, Bill Bulebush, made his way to the crash site, thinking to offer help to local authorities and the presumed crash victims. When he arrived, however, he saw "something that threw him for a loop":

A metallic bullet-shaped object was sticking in the ground at the end of a trench, which it had obviously formed while landing.

"It looked like a big burned orange. It sparkled and twinkled, was about 9 feet wide and 12 feet long. Somehow it gave me the creeps and I got away quickly."

And when he read the Air Force explanation in the papers the next day, he knew they were lying. What he had seen had certainly not been a meteorite!<sup>21</sup>

20 *Ibid.*, p. 169.

21 *Ibid.*, emphasis in the original.

Suffice it to say, it strains credibility to have so many witnesses attest that the military showed up, placed an area of U.S. territory under martial law, and called in NASA specialists, to recover a mere meteorite. The meteorite theory made no sense to local UFO researcher **Stan Gordon** either, since *UFOs* ordinarily traveled at speeds in excess of those calculated for the object, and meteorites do not stop, stand still, and then change course.

Nonetheless, there the matter would have rested, until **James Romansky** came forward as a witness 2 years later (1987). Romansky had been 19 years old at the time of the incident, and a member of the volunteer firefighting team that had arrived first and been instructed to comb the woods for the wreckage of a crashed airplane.<sup>22</sup>

Romansky gave a description of the object that was slightly different than Bulebush's in certain details:

It had the shape of an acorn, made of shining silvery metal which had a light touch of gold in it. Its bottom was surrounded by a kind of ring or, as Jim put it, a kind of metal bumper on which strange writing could be seen. Romansky described it later.

"They looked like Egyptian hieroglyphics, but without any animal signs. There were straight and broken lines, dots, squares and circles." ....

There was no glass, no propeller or jet nozzle, no burst tanks from which any fuel had leaked out, and not even the sign of a hatch or entrance.<sup>23</sup>

22 Hesemann, *op. cit.*, p. 169.

23 *Ibid.*, emphasis in the original.

After Romansky's story was aired on an episode of the television show "Unsolved Mysteries", other witnesses emerged with their own accounts of the incident, and substantially confirmed the account, adding new details of their own.

One of these details was that a late-night convoy of trucks, one including a large flatbed semi-trailer with an object covered in a tarpaulin. Some witnesses report that the tarpaulin was pulled tightly around the object, and its "acorn" shape could clearly be seen. The object was next seen by witnesses at its first apparent destination, Lockborne Air Force base in Columbus, Ohio, where military police units were ordered to surround a hangar and shoot anyone who attempted to enter that did not have a top secret clearance.<sup>24</sup>

It was next apparently seen by a witness, "Myron", who contacted Stan Gordon, and described a similar object. Hesemann's summary of Myron's story is worth citing in full, since it bears directly on my hypothesis:

(Myron) worked as a truck driver for a cement factory belonging to his family at Dayton, Ohio. Two days after the incident occurred at Kecksburg, his firm received a large order for specially glazed bricks from the Wright Patterson Air Field. A representative of the base had had a look at the bricks in stock at the factory and finally ordered 6,500 double-glazed processed bricks, which, he said, "were for building a double-walled shield around a recovered radioactive object." <sup>25</sup>

Myron later glanced inside the hangar to view what was inside.

The object was silhouetted by floodlights behind large silk -parachute-like screens. Myron described "the shadowy outlines of a large bell-shaped object....perhaps about 9 feet wide and 12 feet high. Through a small opening in the tent, Myron could see that it was metallic, like some kind of whitish bronze."<sup>26</sup>

24 *Ibid.*, pp. 169-170.

25 Hesemann, pp. 179-170, emphasis added.

26 *Ibid.*, p. 173.

## C. Analysis

There are a number of curious data points that would appear to connect Kammler's "Bell" with Kecksburg's "Acorn". Hesemann's book, from which the above accounts and quotations were cited, was published in 1998, before Nick Cook's *Hunt for Zero Point*, with its summarization of SS General Sporrenberg's descriptions of **the Bell** were first made known to

an English speaking audience. This means that *the Kecksburg witnesses* record something that sounds eerily like Kammler's Bell.

Consider the following list:

- (1) Both objects are described in very similar terms, as "acorn" or "bell" shaped; the Pennsylvania witnesses could just as easily be describing Kammler's Hell, and Sporrenberg similarly, could just as easily be describing the Kecksburg Acorn;
- (2) Both objects are described as having similar, if not identical, dimensions, being approximately 9 to 12 feet in diameter and 12 to 15 feet in height;
- (3) Both objects had to be housed in a chamber made of "glazed" or "ceramic" bricks, because,
- (4) Both objects apparently gave off strong radioactivity or other strong field effects.

In fact, it is on only one point that the two objects differ, if indeed they are two distinct objects, and that is the consistent testimony by witnesses who actually saw the Kecksburg "acorn" UFO, that some strange form of writing existed around the "bumper" of the object, resembling hieroglyphics to some, "but without the animal and people pictures," as James Romansky puts it, and resembling geometrical forms according to a few others. No similar statements exist for *Kammler's Bell*.

But even this may not necessarily be a sufficient reason to dismiss the possible connection. The kind of writing described may have been a form of runes, a form of writing in which the occult-oriented SS was also interested.<sup>27</sup> These types of symbols can sometimes resemble geometric objects that some witnesses associate with the writing on the Kecksburg UFO. It is much more difficult, however, to find a resemblance between them and "hieroglyphic" writing.

27 For SS rune research, see Dusty Sklar, *The Nazis and the Occult* (Dorset Press, 1989), pp. 25-26, 28.

With regard to point (3), another significant question occurs: why did the Air Force so quickly decide that ceramic, or glazed, brick, would be the best means of shielding the object? There are other more effective, though more costly means of shielding, and cost may have been a leading factor in selection of this method. But the suddenness with which the decision is taken to shield it at Wright Patterson Field with such bricks also suggests a knowledge of and familiarity with the object, and, possibly, of its history as a Nazi secret weapons project. In any case, the swiftness of the military's reaction to assemble a recovery team at Kecksburg also indicates that the object had been tracked by the military for sometime as it flew over Canada and the eastern US. It is as if the military had been expecting it.

And finally, there is yet another odd point that may connect the *Kecksburg Acorn* to the *Kammler Bell*. We have already seen that some "Nazi survival myths" have a secret German base close to the Arctic, operating at a remote location in Canada near Hudson Bay. While I discount the idea, it is perhaps worth noting that the trajectory of the Kecksburg Acorn as it tracked from Canada into the US to its final crash site in Pennsylvania, would, if extended north into Canada, place it along a line more or less where the "Arctic Nazi survival myth" places the alleged secret German base.



**The Trajectory of the Kecksburg UFO 341**

Near the end of his book, **Nick Cook**, recounts a meeting with a friend who had started him off on a quest that he knew would eventually lead Cook back to Nazi Germany.

"Markus" words are a chilling warning:

When the Americans tripped over this mutant strain of non-linear physics and took it back home with them, they were astute enough to realize that their homegrown scientific talent couldn't handle it. That it was beyond their cultural terms of reference. That's why they recruited so many Germans. The Nazis developed a unique approach to science and engineering quite separate from the rest of the world, because their ideology, unrestrained as it was, supported a wholly different way of doing things.... The trouble was, when the Americans took it all home with them they found out, too late, that it came infected with a virus. You take the science on, you take on aspects of the ideology, as well.<sup>28</sup>

28 Nick Cook, *op. cit.*, p. 270.

In any case, it seems that there are enough points of similarity between *Kammler's Bell* and the *Kecksburg Acorn* to at least raise a third alternative as an explanation for it, in addition to the two approaches previously taken, namely, that it was a crashed extra-terrestrial craft or probe of some sort, or a crashed Soviet Cosmos satellite. It may have been a Nazi secret weapons project, that inadvertently got away from its testers, was brought back under control, and deliberately crashed, only to be retrieved again.

The *Kecksburg incident* raises the horrifying possibility that SS Obergruppenfuhrer *Hans Kammler's Bell* and his SS secret weapons *Sonderkommando* survived the war intact, metastasizing throughout the very secretive, and labyrinthine compartmentalization of America's black projects world. This raises the specter that some of "our" black projects may not be ours at all, but someone else's. We are just footing the bill.



*A Sketch of the Crash at Kecksbug*

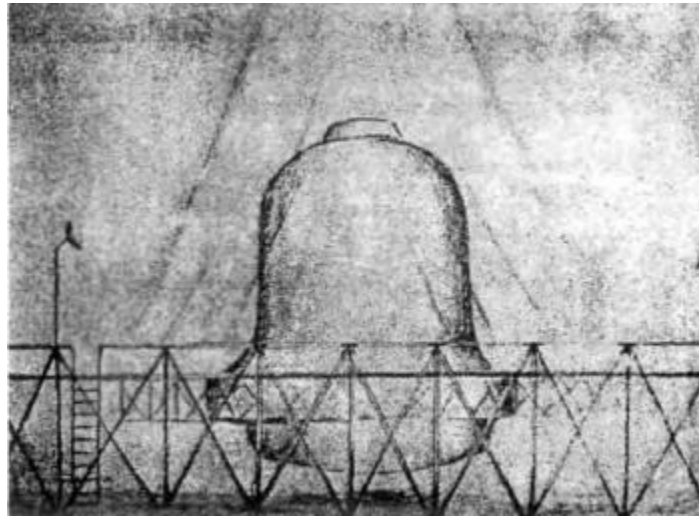

Myron's "Bell" at Wright Patterson Air Force Base

[Back to Contents](#)

## Chapter 18 FINAL THOUGHTS

"By involving the concentration camps, the SS had unwittingly set the seal on any serious postwar investigation of the science and technology it had pursued during the conflict."

"But then Kammler told Speer he was planning to contact the Americans and that in exchange for a guarantee of his freedom he would offer them every thing.... He informed Speer that he was assembling all the relevant experts in Upper Bavaria in order to hand them over to US forces. "

**Nick Cook**

The Hunt for Zero Point <sup>1</sup>

<sup>1</sup> Nick Cook, *The Hunt for Zero Point*, pp. 203, 165, respectively.

What emerges from all this? Three broad areas seem to be affected by the revelations and speculative possibilities outlined - and I stress, only outlined - in this book: physics, history, and politics/culture. Clearly there are sufficient, though admittedly scanty, technological references, reports, diagrams, and witness accounts, to reveal the fact that the Third

Reich had developed areas of physics and technology *scarcely imaginable, even today*. That the Germans were much farther along in atom bomb development seems clear, even if they did not successfully test a device, as I believe they actually did.

We know too certain broad outlines of that physics. It was based on a dynamic conception of the aether as a topological space, having most likely certain inertial properties of its own. It was likewise a dynamic aether, in which particle reactions appear to have been modeled as geometries and combinations of forms of rotation. It appears, above all, to have been a physics based on the pursuit of the will to power, and thus willing to entertain the most apparently unorthodox ideas - from the standpoint of today's "public consumption" physics - in that pursuit.

This disturbing potentiality raises a more problematical aspect of what has been outlined. Almost any way one views it, it seems clear that the end of the war and the strange deployments on the Allied and German side exhibit the characteristics of a race against time, the Nazis trying to prolong the war by every desperate means available, and the Allies, with almost equal desperation, trying to bring it to a close. It also seems clear that the Allies and particularly the Americans were racing very deliberately toward targets that their intelligence, at a very high level, was guiding them to.

Beyond that, the notion that the Germans successfully exploded even a large fuel air bomb - which they very evidently did - calls much into question, not only about the publicly stated origin and development of that particular piece of contemporary mass destruction hardware, but also calls into question the whole massive expenditure of billions if not trillions of dollars by both the Soviet Union and the United States on thermonuclear weapons. A fuel air bomb is much cheaper, causes a level of destruction on the order of at least small atom bombs, which are considered strategic weapons of mass destruction.

If the Nazis succeeded with this device, as they very much did, does this explain perhaps the strange accounts from the Eastern Front of some sort of weapon of mass destruction being used on the Russians? One that would drive them, in desperation, to pass on to Berlin via some neutral channel, to cease and desist or they would begin using poison gas? The development of *the fuel air bomb* in some early prototype by the Nazis explains too another mystery, for if they did successfully develop an atom bomb - then their reasons for not using it have already been given: they were being developed as detonators for something far more destructive.

In any case, the various revelations and speculations presented make one thing abundantly clear. Our history began to be massively re-written even before the end of the war, and has been manipulated to an extraordinary degree since then. Nowhere does this seem more in evidence than in the fact that there appears to have been a successful - albeit only prototypical - development by the Nazis of a very different type of physics, a physics that remains off the books.

This to me is the most disturbing aspect of all that my own, and other's, research has uncovered, for a "two track" science - one developed and controlled in secret by the few, and for their own aggrandizement and pursuit of power, and the other developed in public and maintained by the same oligarchy with their power to grant or refuse funding, and their power thereby to control journals and what types of research will be "tolerated" - is the utmost mockery of science. And when science is mocked, morality is mocked because truth is mocked, and this brings us to the third area, the most disturbing of all: politics/culture.

The *Will to Power* was what drove the Nazi Regime in any endeavor it undertook, whether the conventional military operations it conducted, to the death camps and genocide it was preparing for the world, to the occult and esoteric research of the Ahnenerbe and the Kammlerstab. That *Will to Power* seems evident in all aspects of the science implied by the things discussed in this book. And this compels a final observation.

Many people — and I would number myself among them - view the Zero Point Energy as our best long range hope to resolve some of the more pressing environmental and energy problems of our planet. It does hold almost limitless promise for a whole host of new technologies, and there is enough in the literature to convince me that various scientists and inventors - the ones not hobbled by academic tenure or the agendas of grant foundations and government - are on the verge of exciting discoveries.

But with that energy comes the potential for weaponization of a power and sophistication that we with our thermonuclear popguns can only imagine. With it comes a view of the universe subject to the *Will to Power*. A moral consequence, and commitment, is implied in such a physics. It would therefore seem to imply, inevitably, precisely a "two-tiered" science, one for the public, and one for the initiate, when he or she is spiritually able to handle the extraordinary power it makes available to them in non-destructive ways. There is a degree of evidence that this is, in fact, what happened in ancient times, and certainly it seems to have happened to the Kammlerstab's work after the war. Perhaps, at least initially, its contents were so sensational that, for moral reasons, it was decided to keep it under wraps.



But the *Will to Power* remains closeted within that science and the black projects it engendered and no doubt continues to engender.

The power to tinker with the topological properties of space, and the energy resulting from it, is an absolute one. And absolute power corrupts absolutely.

[Back to Contents](#)

## APPENDIX

### A SHORT NOTE ON THE KRAFTSTRAHLKANNONE

On pages 221-223 reference was made to the Kraftstrahlkannone and one possible explanation of its working., based solely on the schematic. Like so much of the "wonder weapons", however, its principles of operation can be interpreted along a variety of lines. However, a translation of the German accompanying this device yields another principle of operation:

The KSK armament... is based on the Noar procedure: Around a central axis lie eight weapon-tubes bound in two tiers. With the discharge, four energy beams leave the gun sheathing with a millisecond delay between the firing of the first four tubes and the second four tubes. At target, these two energy beams are united, the effect on which is greatly increased strength ....

The destructive effect on target is increased with increased tube length of the weapon because the beam weapon :

1. becomes stronger the longer the time in the barrel
2. through increased graduations inside the tube, the potency can be increased....<sup>1</sup>

<sup>1</sup> Henry Stevens, *Rumored German Wonder Weapons*, report Four: *The German Death Rays*, pp. 17, 19.

While the corroborative evidence for this weapon, if it ever existed, is scanty, the principle on which it is based - pulses leaving the weapon at different times but arriving on target at the same time - is exactly that of scalar weaponry, which creates from two or more such pulses an interference pattern on target, as detailed in a diagram by Lot. Col. (Ret) [Tom Bearden](#) (below).

It is to be noted that Bearden maintains thorough his numerous books that this basic principle of so-called [scalar weaponry](#) was first found by the Germans during the Second World War, and subsequently exploited and weaponized by the Soviet Union in the decades after the war. The weapon is alleged to have been employed on the German saucers.

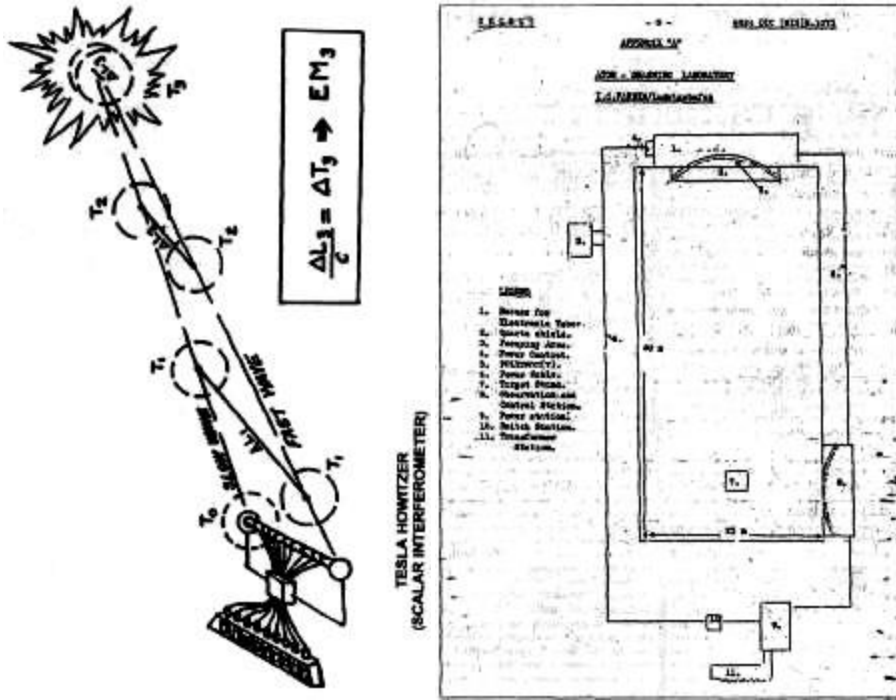

PW Intelligence Bulletin No 2/32 's  
 Sketch of the Ludwigshafen- Heidelberg Quartz Reflector High-Voltage Disintegration Ray Installation



New York Times June 29, 1945  
 Article About Nazi Orbital Solar Mirror Weapon



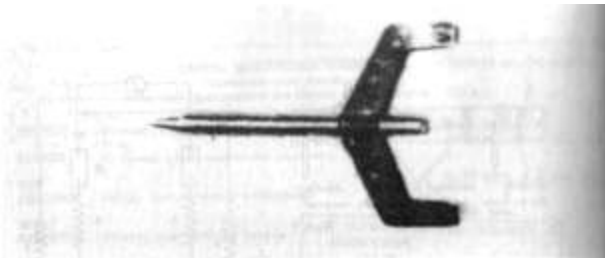

Above: Wave guide used in electromagnetic experiments at Peenemünde.



Above: A V-2 rocket launch at the moment of lift-off. (Left) Used as for a long period by the PrVA, Peenemünde.



Above: SS Gruppenführer Hans Kammler in 1944.



Above: Launching table for rocket engine as of 1944.

Left: Map of the town, Test Center at Peenemünde.

**Wörterbuch (Klassenarbeiten)**

Flugzeug-Gruppen, Bauart / Anzahl Versuchsflüge

HAUNEBU I (Verheerung I Bauart)	56	8-07
HAUNEBU II (Verheerung I Bauart)	108	8-07
HAUNEBU III (Verheerung I Bauart)	19	8-07
HAUNEBU IV (Verheerung I Bauart)	24	(Schubtrieb)

**Wörterbuch:**  
 Beschreibung der Versuchsflüge  
 und Ergebnisse - HAUNEBU I

HAUNEBU I

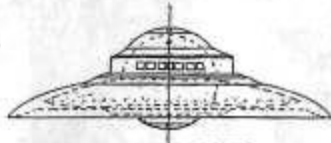

**Wörterbuch (Klassenarbeiten)**

HAUNEBU I, 1939  
 Beschreibung der Versuchsflüge  
 und Ergebnisse - HAUNEBU I

HAUNEBU I, 1939  
 Beschreibung der Versuchsflüge  
 und Ergebnisse - HAUNEBU I

HAUNEBU I, 1939  
 Beschreibung der Versuchsflüge  
 und Ergebnisse - HAUNEBU I

Alleged photocopy of SS plans for a Haunebu I being designed in 1939. From the German book *Die Dunkle Seite Des Mondes (The Dark Side of the Moon)* by Brad Harris (1996, Pandora Books, Germany).



Alleged photocopy of SS plans for a Haunebu II being designed in 1943. From the German book *Die Dunkle Seite Des Mondes (The Dark Side of the Moon)* by Brad Harris (1996, Pandora Books, Germany).

HAUNEBU II

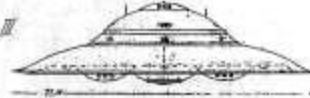

**Wörterbuch (Klassenarbeiten)**

HAUNEBU III, 1945  
 Beschreibung der Versuchsflüge  
 und Ergebnisse - HAUNEBU III

HAUNEBU III, 1945  
 Beschreibung der Versuchsflüge  
 und Ergebnisse - HAUNEBU III

HAUNEBU III, 1945  
 Beschreibung der Versuchsflüge  
 und Ergebnisse - HAUNEBU III

Alleged photocopy of SS plans for a Haunebu III being designed in 1945. From the German book *Die Dunkle Seite Des Mondes (The Dark Side of the Moon)* by Brad Harris (1996, Pandora Books, Germany).

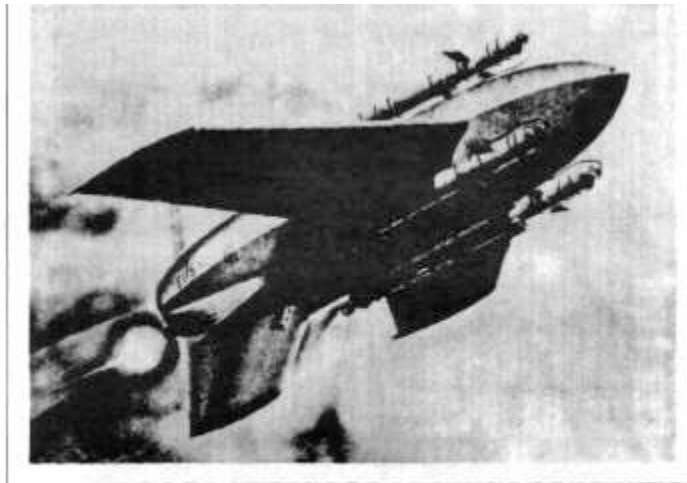

Enutan 4 in flight. This was an exceptionally powerful rocket intended to reach supersonic speed, a ceiling of 52,000 feet, and distant targets under radio control. It is but one of many missiles produced by the German secret weapons program (courtesy of "German Secret Weapons of World War II" by I.V. Hogg, 1970).

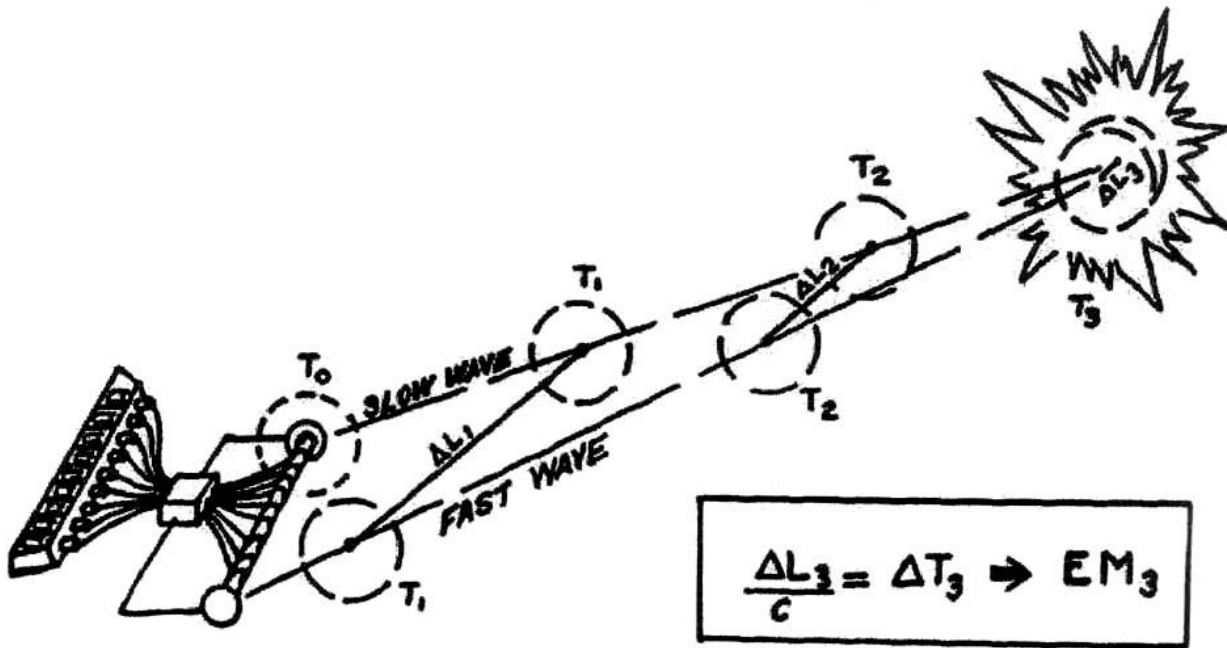

**TESLA HOWITZER  
(SCALAR INTERFEROMETER)**

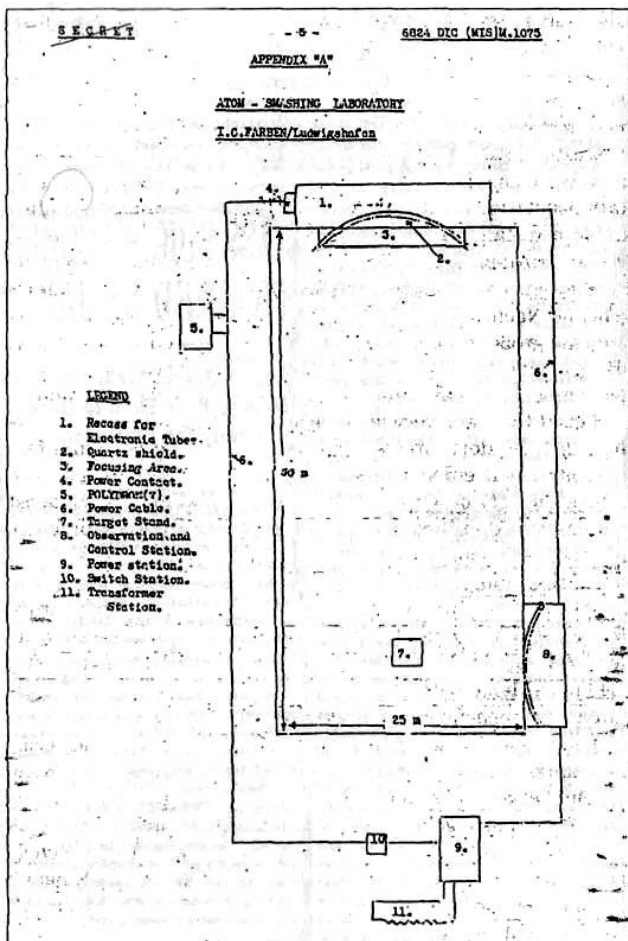

### Nazis' Scientists Planned Sun 'Gun' 5,100 Miles Up

THE NEW YORK TIMES, 29-6-45

By GLADWIN HILL (Page 4)

PARIS, June 28—German scientists, a high United States Army ordnance officer declared today, were soberly working on a project of contriving a platform 5,100 miles in the air from which, within a matter of fifty or 100 years, it was believed, it might be possible to harness the sun's rays to demolish nations at will and rule the world.

"Fantastic" is the only word that comes to mind for this project. Yet "fantastic," officers here avow on the basis of the caliber of the scientists involved and the cold, sound method of their work, is a classification into which the project definitely cannot be put.

"We were interested," ordnance officers said after exhaustive interrogation of the scientists, "with their practical engineering minds and their distaste for the fantastic." They had even figured the dimensions of a mirror that would be necessary up 5,100 miles to focus the sun's rays for the purpose — three kilometers (1.86 miles) square.

These are some of the scientists who devised so recently the inconceivable buzz-bombs and the V-2 rocket bombs. They are some of the scientists who, it was disclosed today, had virtually perfected, in addition to the previously revealed secret weapons, a method of launching V-2 rocket bombs from submarines 300 feet under water that might have blasted New York as London was blasted.

They are scientists who, on the basis of their amazing rocket work, take it for granted that transatlantic mail rockets are a development of only a few years hence and that forty-minute transatlantic passenger rockets are

Producing a tremendous volume of secret, suicide weapons and training a man to ride each device to his doom during the Pacific war's "inevitable" showdown on the Japanese home islands, the Tokyo radio reported today.

"Special attack" or suicide corps bases have been established throughout the islands, the report said, and the weapons are being manufactured on a scale that will almost equal "the total number of tanks and guns used in the European war."

Japan's "all-out" suicide plans were disclosed amid a flurry of special announcements by the Tokyo radio as the empire stripped down to the barest essentials of fighting existence and her leaders held a series of emergency conferences.

Discussing the mass production

**MASS SUICIDE CORPS  
TRAINED BY JAPAN**

**Most of Secret Weapons, With  
Man to Ride Each to Doom,  
Ready for 'Showdown'**

By The United Press.

WASHINGTON, June 28—Japan

Continued on Page 5, Column 2.

ITEM NO. 4  
FILE NO. XXXI-59

COPY No 23

0239331

*871.1202*  
*10*

**RESTRICTED**



**GESELLSCHAFT FUR  
GERATEBAU**

**FILE**  
INTELLIGENCE LIBRARY  
29 MAR 1946  
SCIENTIFIC BRANCH

MIS-23933

LIBRARY FILE COPY  
Must be Forwarded to  
the Intelligence Division  
within 72 Hours

*\*Mil - 1*  
*Route*  
*Sci*  
*Sub*

**RESTRICTED**

**COMBINED INTELLIGENCE OBJECTIVES  
SUB-COMMITTEE**

**RECORDED**  
343

1946 Restricted document from the OSS Intelligence Library on German experiments in electromagnetism.

CENTRAL INTELLIGENCE AGENCY  
INFORMATION FROM  
FOREIGN DOCUMENTS OR RADIO BROADCASTS

REPORT NO. OO-V-27452

CD NO. . . . .

COUNTRY Germany, USSR, French Equatorial Africa, Syria,  
Iran

DATE OF INFORMATION 1952 - 1

SUBJECT Military - Unconventional aircraft

HOW PUBLISHED Daily, thrice-weekly newspapers

DATE DIST. 18 Aug 1953

WHERE PUBLISHED Athens, Brazzaville, Tehran

DATE PUBLISHED 11 Mar - 20 May 1953

LANGUAGE Greek, French, Persian

CENTRAL INTELLIGENCE AGENCY	
CLASSIFICATION	3
Cancelled	
Classified by	
BY AUTHORITY	SUPPLEMENT TO
Name	REPORT NO.
Office	
Date	16 Mar 1955

THIS IS UNEVALUATED INFORMATION

SOURCE Newspapers as indicated.

ENGINEER CLAIMS "SAUCER" PLANS ARE IN SOVIET HANDS;  
SIGHTINGS IN AFRICA, IRAN, SYRIA

GERMAN ENGINEER STATES SOVIETS HAVE GERMAN FLYING SAUCER EXPERTS AND PLANS  
Athens, I Vrhdyri, 13 May 53

Vienna (Special Service) -- According to recent reports from Toronto, a number of Canadian Air Force engineers are engaged in the construction of a "flying saucer" to be used as a future weapon of war. The work of these engineers is being carried out in great secrecy at the A. B. Roe Company [transliteration from the Greek] factories.

"Flying saucers" have been known to be an actuality since the possibility of their construction was proven in plans drawn up by German engineers toward the end of World War II.

Georg Klein, a German engineer, stated recently that though many people believe the "flying saucers" to be a postwar development, they were actually in the planning stage in German aircraft factories as early as 1941.

Klein said that he was an engineer in the Ministry of Speer [probably refers to Albert Speer, who, in 1942, was Minister for Armament and Ammunition for the Third Reich] and was present in Prague on 14 February 1945, at the first experimental flight of a "flying saucer."

During the experiment, Klein reported, the "flying saucer" reached --  
alters within es and --

1952 CIA document mentioning German flying saucers and the Canadian AVRO saucer.



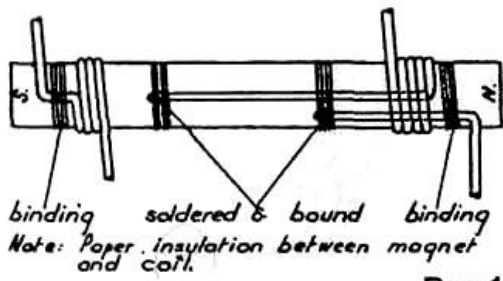

Rys.1

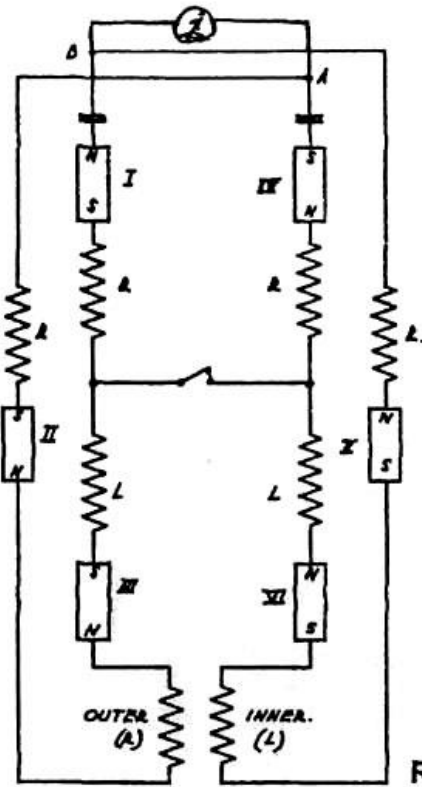

Rys.3

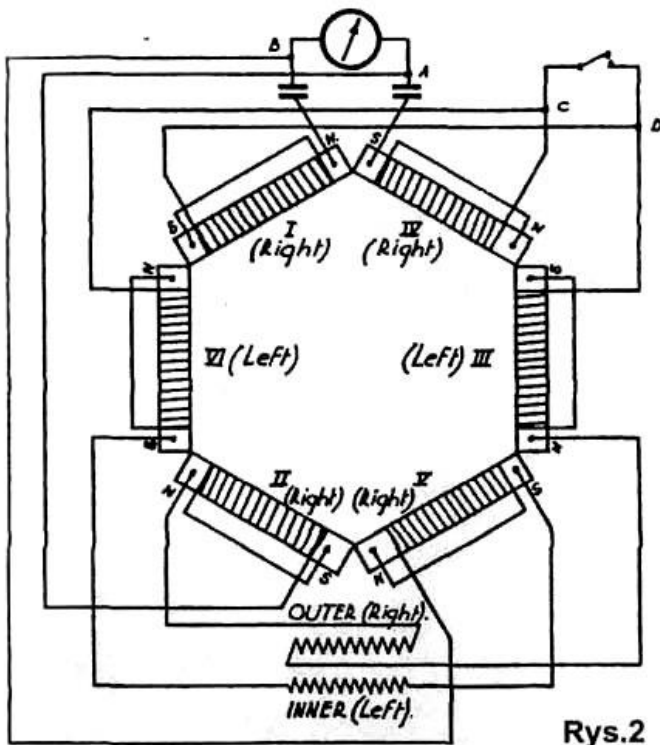

Rys.2

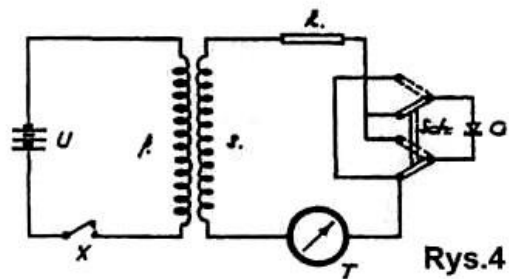

Rys.4

1933 schematics of the Coler Converter from a British Intelligence document.

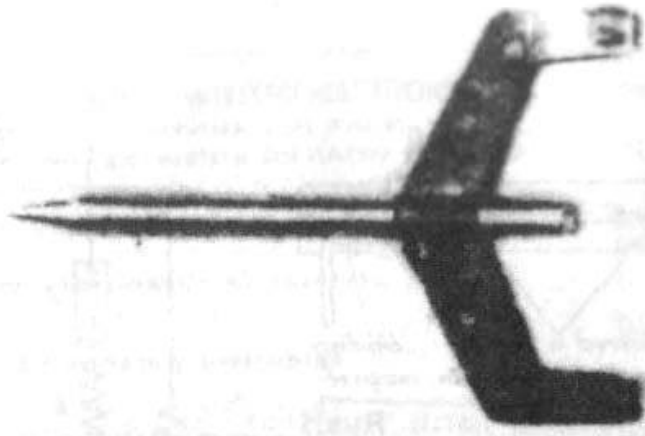

Above: Wave guide used in electromagnetic experiments at Peenemünde.



Above: SS Gruppenführer Hans Kammler in 1944.

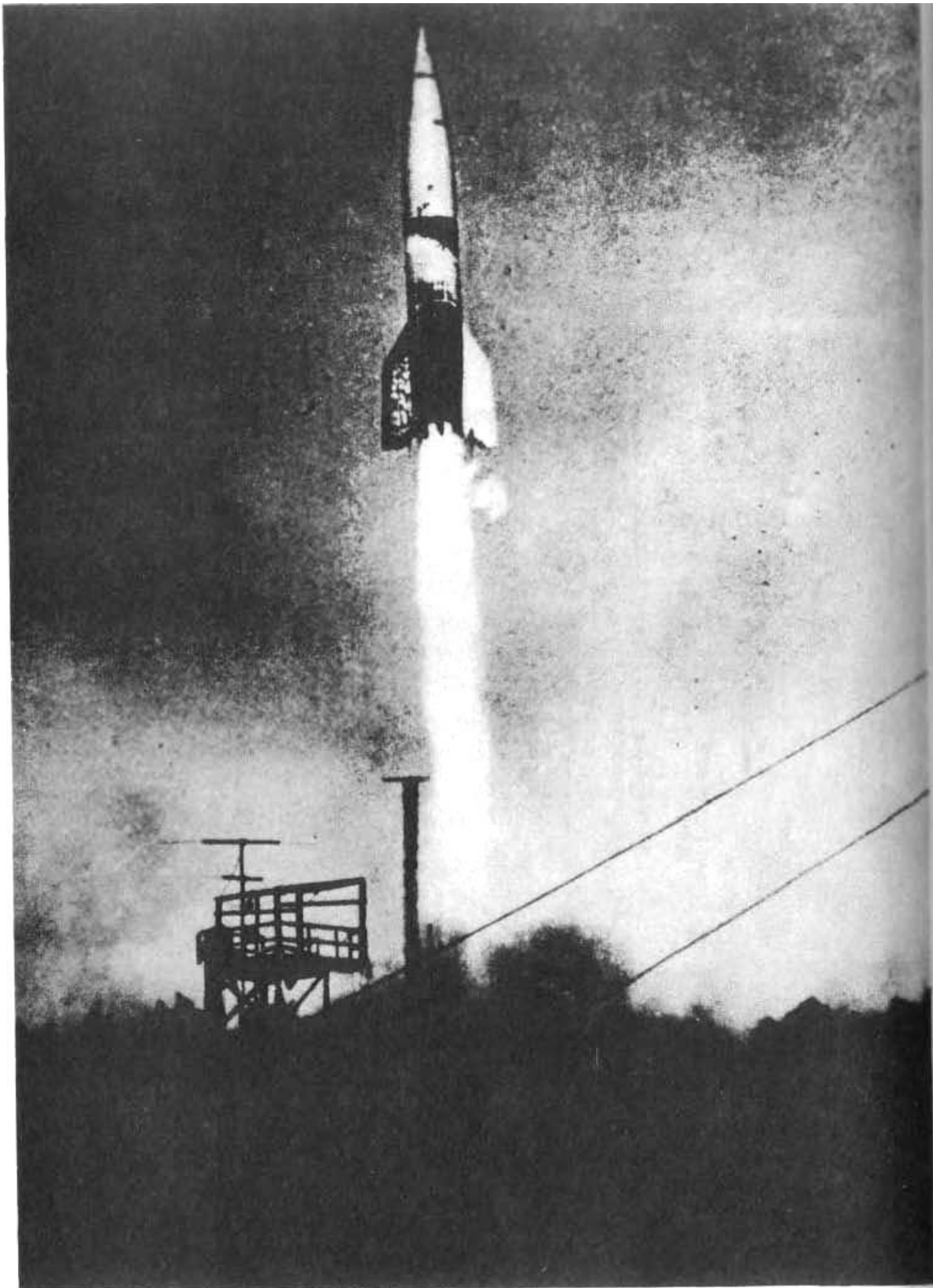

An A4 in a successful launch in the autumn of 1943 at Blizna, spied on for a long period by the Polish Resistance.

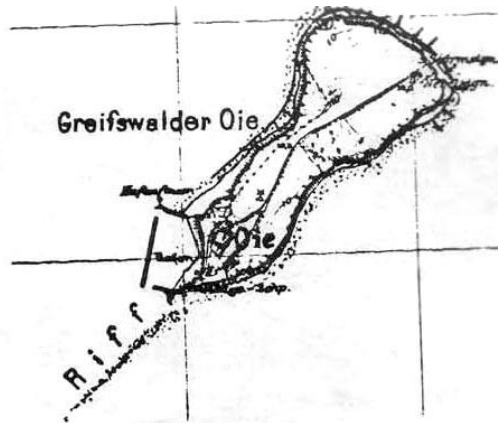
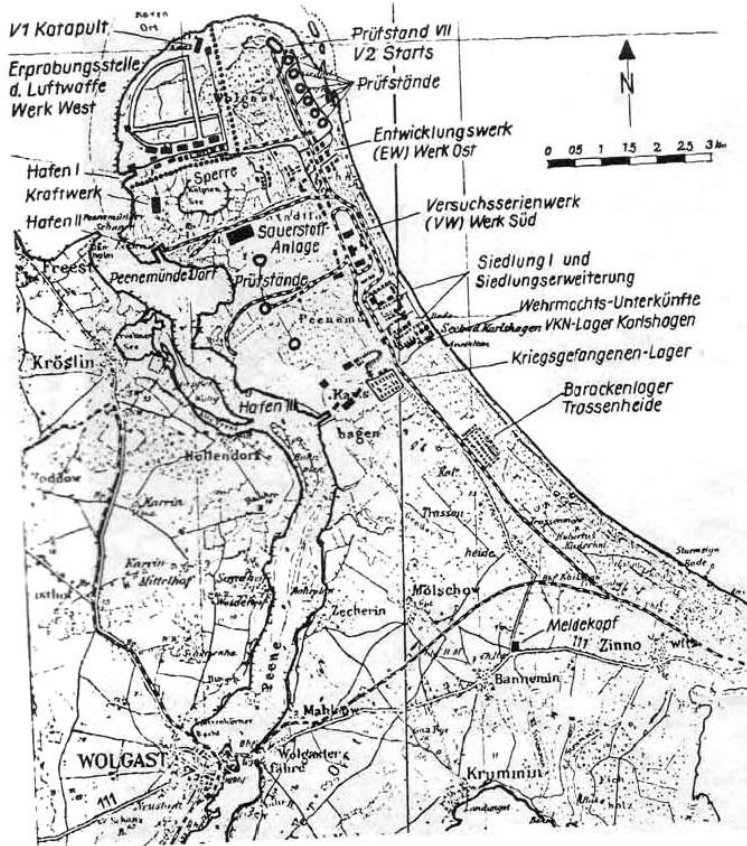

Above:  
Launching island for rocket testing as of 1937.

Left:  
Map of the Army Test Center at Peenemünde.

## Geheim Kommandoobjekt

Flugkreisel-Erprobung, Stand / Anzahl Erprobungsflüge:

HAUNEBU I (vorhanden 2 Stück)	52	E-IV
HAUNEBU II (vorhanden 7 Stück)	106	E-IV
HAUNEBU III (vorhanden 1 Stück)	19	E-IV
(VRIL I) (vorhanden 17 Stück)	84	(Schwamm)

Empfehlung:

Beschleunigen von Abschlussprüfung  
und Produktion „Haunebu II“  
+ „VRIL I“

HAUNEBU I

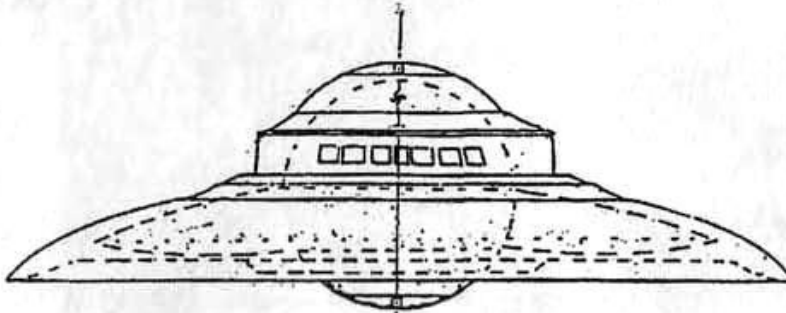

MITTELSCHWERER BEWAFFNETER FLUGKREISEL, TYPE „HAUNEBU I“

Durchmesser: 25 Meter  
Antrieb: Thule-Tachyonator 7b  
Steuerung: Meg-Feld-Impulsor 4  
Geschwindigkeit: 4800 Kilom.p.Std. (rechner. bis 17000)  
Reichweite in Flugzeit: 18 Stunden  
Bewaffnung: 2 x 8cm KSK in Drehtürmen und 4 x Mk 108, starr nach vorn  
Außenpanzerung: Doppel-Vietalen  
Besatzung: 8 Mann  
Weltallfähigkeit: 60 %  
Stillschwebefähigkeit: 8 Minuten  
Allgemeine Flugfähigkeit: Tag wie Nacht  
Grundsätzliche Einsatztauglichkeit: 60 %  
Frontverfügbarkeit: Nicht vor Jahresende 44

Bemerkung: Die SS-E-IV hält Konzentration auf bereits im Versuch stehende „Haunebu II“ für sinnvoller als an beiden Typen parallel weiterzuarbeiten. „Haunebu II“ verspricht entscheidende Verbesserungen in nahezu allen Punkten. Höhere Herstellungskosten scheinen gerechtfertigt - besonders mit Blick auf Führer-sonderbefehl, Flugkreisel betreffend.

Alleged photocopy of SS plans for a Haunebu I being designed in 1939. From the German book *Die Dunkle Seite Des Mondes (The Dark Side of the Moon)* by Brad Harris (1996, Pandora Books, Germany).

HAUNEBU II

7. November 1943  
SS-Entwicklungsstelle IV

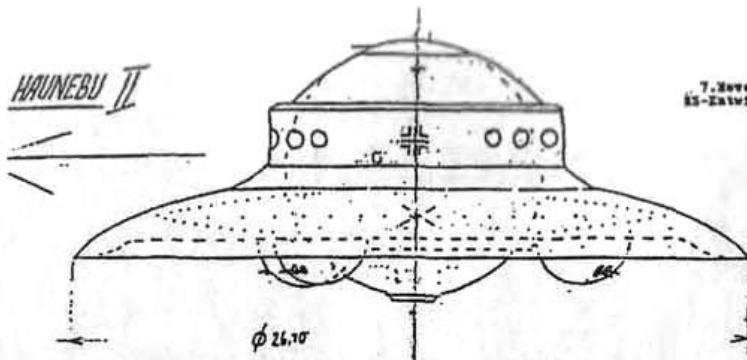

**MITTELSCHWERER BEWAFFNETER FLUGKREISSEL, TYPE „HAUNEBU II“**

Durchmesser: 26,7 Meter  
 Antrieb: „Thule“-Reaktor 7a (gepanzert;  $\phi$  77.-Scheibe: 23,1 Meter)  
 Steuerung: Mag-Feld-Impulsor 4a  
 Geschwindigkeit: 6000 Kilometer p. Stunde (rechnerisch bis ca. 21000 möglich)  
 Reichweite (in Flugdauer): ca. 55 Stunden  
 Bewaffnung: 6 x 8 cm KSK in drei Drehtürmen, unten, eine 11 cm KSK in einem Drehturm, oben  
 Außenpanzerung: Dreischicht-Vielstufen  
 Besatzung: 9 Mann (arg. Transportverm. bis zu 20 Mann)  
 Weiteffektivität: 100 %  
 Stillenwechselfähigkeit: 10 Minuten  
 Allgemeines Flugverhalten: Tag und Nacht, Wetterunabhängig  
 Grundstatistische Einsatztauglichkeit (XT): 85,5 %  
 Verflugbarkeit „Haunebu II“ (bei weiter gutem Erprobungsverlauf wie YT) ab Oktober.  
 Dazu Serienherstellung ab Jahreswende 1943/44, jedoch noch ohne verbesserte Kraftstrahl-  
 Kavon „Donar-Jet XIV“, deren Prototypen nicht vor Frühsommer 1944 abgeschlossen werden  
 kann.  
 Von Führer verlassene hundertschrittweise Einsatzreife rundum bis allerdings  
 nicht vor Ende nächsten Jahres erwartet werden. Erst ab etwa Serie 9.  
 Begerkung zuständige SS-Entwicklungsstelle IV: Die neue deutsche Technik und  
 damit vor allem Flugkreisel und KSK wird wegen der noch zeitraubenden Herstellungs-

Alleged photocopy of SS plans for a Haunebu II being designed in 1943. From the German book *Die Dunkle Seite Des Mondes (The Dark Side of the Moon)* by Brad Harris (1996, Pandora Books, Germany).

HAUNEBU III

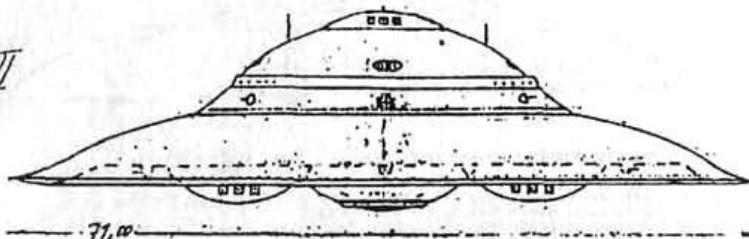

**SCHWERER BEWAFFNETER FLUGKREISSEL „HAUNEBU III“**

Durchmesser: 77 Meter  
 Antrieb: Thule-Reaktor 7a plus Schumann-Levitator (gepanzert)  
 Steuerung: Mag-Feld-Impulsor 4a  
 Geschwindigkeit: ca. 7000 Kilom. p. Stunde (rechnerisch bis zu 40000)  
 Reichweite (in Flugdauer): ca. 9 Wochen (bei 8-L-Flug 406 mehr)  
 Bewaffnung: 4 x 11cm KSK in Drehtürmen (3 unten, 1 oben), 10 x 8cm KSK  
 in Drehtürmen plus 6 x Nr 100, 8 x 1cm KSK für Gegenwehr  
 Außenpanzerung: Dreischicht-Vielstufen  
 Besatzung: 32 Mann (arg. Transportverm. max. 70 Personen)  
 Weiteffektivität: 100 %  
 Stillenwechselfähigkeit: 20 Minuten  
 Allgemeines Flugverhalten: Wetterunabhängig Tag und Nacht  
 Grundstatistische Einsatztauglichkeit: Etwa 1915.  
 Bemerkung: SS-E-IV hält den Hinweis für notwendig, daß in  
 „Haunebu III“ ein größeres Verh. deutscher Technik im ent-  
 stehen ist, wegen der allgemeinen Materiallage aber alle  
 Kräfte auf den schneller verfügbaren Haunebu II gesetzt  
 werden sollten.  
 Einleiten mit dem leichteren Flugkreisel „Vril“ der Schumann-  
 Gruppe könnte „Haunebu II“ die von Führer aufgestellten  
 Forderungen sicherlich erfüllen.

Alleged photocopy of SS plans for a Haunebu III being designed in 1945. From the German book *Die Dunkle Seite Des Mondes (The Dark Side of the Moon)* by Brad Harris (1996, Pandora Books, Germany).

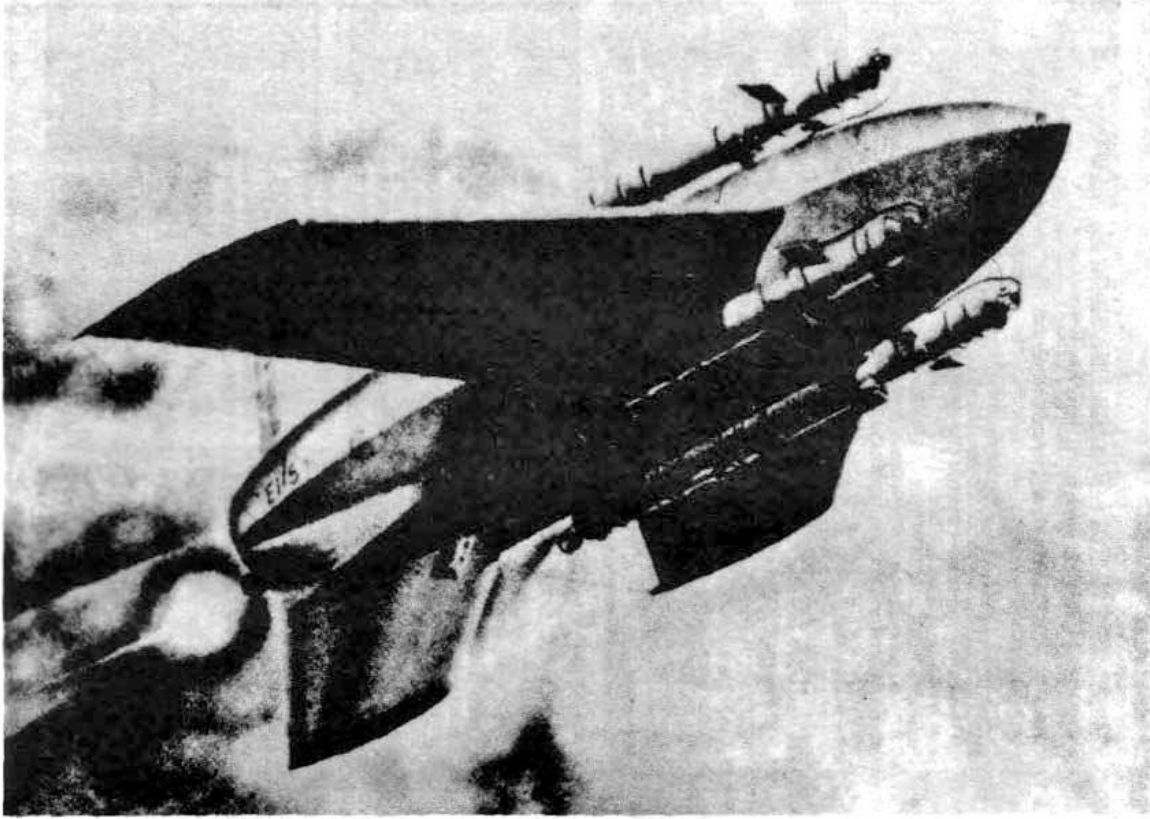

Enzian 4 in flight. This was an exceptionally powerful rocket intended to reach supersonic speed, a ceiling of 52,000 feet, and distant targets under radio control. It is but one of many missiles produced by the German secret weapons program (courtesy of "German Secret Weapons of World War II" by I.V. Hogg, 1970).

**Henry Stevens**  
**- Hitler's Flying Saucers -**  
**A Guide to German Flying Discs of the Second World War**  
by Henry Stevens

## TABLE OF CONTENTS

- [PREFACE](#)
- [CHAPTER ONE](#): THE SITUATION WITHIN NAZI GERMANY
- [CHAPTER TWO](#): RELIABLE SOURCES
- [CHAPTER THREE](#): AN OVERVIEW OF THE GERMAN CONVENTIONAL SAUCER PROJECTS
- [CHAPTER FOUR](#): THE GERMAN FIELD PROPULSION PROJECTS
- [CHAPTER FIVE](#): LORE AND LOOSE ENDS: A DISCUSSION OF GERMAN SAUCERS
- [CHAPTER SIX](#): "SONDERBUERO"
- [CHAPTER SEVEN](#): DISPOSITION OF GERMAN SAUCER TECHNOLOGY AFTER THE WAR
- [CHAPTER EIGHT](#): CONCLUDING THOUGHTS

MULTIMEDIA [Hitler's Flying Saucers](#)

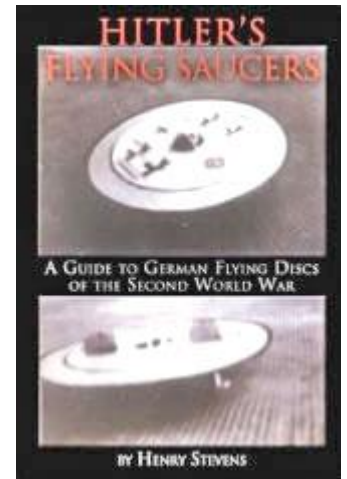

[Return to German Disc Aircrafts](#)  
[Return to Temas / Libros-Tratados](#)

## PREFACE

This book is a guide into the world of German flying discs. You may have picked up this guide because you are unfamiliar with the German production of flying saucers during World War Two. The basics of this production will be revealed to you in the following pages. An adventure awaits you.

On the other hand, you may be looking for nothing more than a rational explanation of the UFO phenomenon. The UFO phenomenon involves sightings of unidentified flying objects. This means that any unidentified flying object is a UFO, regardless of its alleged source. Because the object is unidentified, the object's source is also undetermined. Only a leap of faith can connect UFOs to an extraterrestrial course without first introducing proof. A radical hypothesis such as an extraterrestrial origin of UFOs requires overwhelming proof in order to be generally accepted. No such overwhelming extraterrestrial proof has ever been offered which has stood up to scrutiny. No crashed alien craft have ever been produced by anyone, inside or outside government. Likewise, no alien bodies have ever been found. No extraterrestrial culture, or alien technology has ever been uncovered by anyone. There is simply no actual evidence at all linking UFOs with an extraterrestrial source. Therefore, no such leap of faith should be made. We need to start all over again. All rational earthly explanations need to be exhausted before any extraterrestrial theories are even put forth.

Unfortunately, the simple truth is that, for the most part, UFO research has done a leap-frog to the extraterrestrial explanation without ever adequately exploring and exhausting a terrestrial origin. This statement is inclusive of everyone regardless of background or education. It applies to the charlatan UFO attention-getters as well as to former NASA scientists with Ph.D.s. This is the condition of our current state of affairs in the UFO world.

Let me expound on this. For over fifty years, the UFO research paradigm has been fundamentally wrong. A proper attempt to explain the UFO phenomenon would involve a gathering of the evidence and then explanation by proceeding from simple solutions involving known facts and conditions and totally exhausting theses possibilities before postulating explanations, conditions, or entities not represented by fact. Only after known facts fail us can we move on to postulate explanations beyond our realm of experience.



Even then, an idea which may fit the observed facts but which is not in evidence itself cannot be accepted as fact until it is tested. This is nothing new. This is simply the way logic and science test new explanations of reality. This method is the foundation of our modern western technological culture.

Unfortunately, research in the field of flying saucer phenomena has never been undertaken with this principle in mind. More and more frequently, UFOs are attributed to an extraterrestrial source by the media, or the "witnesses", as a sort of knee-jerk reaction. It seems if one sees something for which he has no prior reference, then it must be extraterrestrial as a matter of course. Over the years sightings have become "encounters," then "abductions." Such reports are increasing even as the use of regression hypnosis replaces the scientific method for finding the truth. The same individuals often have repeated "experiences" each of which becomes stranger than the last.

If no real research has ever been done on the UFO phenomena, then how has this extraterrestrial theory crept into popular culture? One simple answer is the media. The media loves extraterrestrials. Why? It is because the extraterrestrial hypothesis is marketable. It sells copy. Just look at the number of books, magazines, movies and television programs devoted to this explanation. Look at your check-out counter in the supermarket.

The government itself is another answer. The word "government" from here on will basically mean the government of the United States of America but will sometimes include other governments, as specified. The government has used "flying saucers" to cover its own testing of secret aircraft. It uses the UFO-extraterrestrial ploy superbly. When a UFO is seen by civilians, a controlled procedure is enacted. This procedure plants or encourages witnesses who expound an extraterrestrial origin in a given sighting. The government may even go so far as to fund television programming and magazines devoted to this explanation. After all, a huge part of the C.I.A.'s budget goes into such covert conditioning of the American people. However, Americans are not the first to be fooled, as we shall see.

In most cases, any extraterrestrial hypothesis is acceptable to government manipulators, especially if it is so ridiculous that the witnesses end up discrediting themselves. The government is so successful at this that the entire topic of UFOs has become somewhat of a joke. This is done deliberately. Thus, serious people with "something to lose" are afraid to stake their reputations on a public announcement of their UFO experience, no matter how real it

may have been. At this point the government has achieved its purpose which is to discredit and suppress all serious inquiry into the UFO question.

Supposedly, UFO research has been left to large, well-financed UFO "research organizations". The largest of these is MUFON (Mutual UFO Network). This organization "trains" people to report sightings, then collects the data and organizes it using some sort of multi-variant analysis into something meaningful. Over the years MUFON has had the opportunity to collect and "organize" thousands of sightings into something meaningful.

In reality, the information is organized into gibberish. After a body of knowledge has been studied and organized, usually, certain facts or at least generalizations can be gleaned from this kind of work. In its fifty years of existence can anyone name one new fundamental fact that MUFON has provided us? They have provided us with nothing. Someone once said that MUFON is really a black hole into which information is attracted and does not have the power to escape on its own. We will return to MUFON and explain this reasoning at a later point.

If we are to seek any real explanation of the UFO phenomenon, we must make a clean break with the past. We must go back to the basics of simplicity and logic. One basic question is this: could we humans be capable of making the unidentified flying machines which have been seen in abundance in the sky since the Second World War? Until we answer that question in the negative, there is no reason to postulate an alien origin for UFOs.

One purpose of this book is to give an individual new to this subject an overview into the study of German flying discs. Never fear, this is not a disjointed spook-hunt, chasing sightings and abductions. There are real facts in this field. There are real people with real names and histories and there are real saucer designs.

Another purpose is to give the reader references, upon which statements in this book are based. Given these references, the reader may then research the topics of particular interest in more detail.

The research methodology is straightforward. We will listen to what is claimed about German saucers by Germans of those times or from other individuals who are in a position to know something about this topic. We then attempt to verify it using an independent historical source. Corroboration from other independent sources, especially from witnesses, is also acceptable and important. Photographs are important but nowadays pictures can be manufactured on a computer. Well-documented pictures which

appeared before the modern computer age are perhaps best. Also, pictures accompanied with negatives may be considered better documents than those without negatives.

Government documents can be great sources of confirmation. Unfortunately, governments cannot be trusted and have historically attempted to manipulate UFO research. Therefore, these sources are best not used to formulate ideas but to confirm ideas first developed through independent sources.

Politically, time is on our side. Since the Berlin Wall fell, more and more German researchers are going public with their findings. There is more freedom to research this subject now than at any time in the past sixty years. As each piece fits into the puzzle, a consensus of public acceptance acknowledging the reality of German flying discs

grows. All we really have to do is find the pieces, confirm them and

keep putting them together. The truth will emerge by itself and in the end nobody, no special interest of any sort, will be able to deny this basic truth.

The writer of this book is not an authority to be believed upon face-value alone. New assertions made in this book about German saucers will be accompanied with documentation. Assertions made by others will be accompanied with their references. This book will briefly touch upon most of the facts, ideas, writers and researchers in this field. With the sources given, the reader will be able to confirm the veracity of the position put forth independently.

In an attempt to explain the field of German saucers to someone new to it some background is necessary. First, we will discuss the situation within wartime Germany. Then, there will follow a discussion concerning reliable sources in this field. An overview of German flying discs will follow. Finally, various trains of thought or schools or thought in this field will be presented in a discussion section along with some odds and ends which do not fit into any neat pattern. At that point, the post-war disposition of German saucer technology will be discussed before concluding with some thoughts on the topic.

[Click images to enlarge](#)



A meeting of Germany's early rocket pioneers, including Rudolph Nebel at left, Hermann Oberth, to the right of the rocket, Klaus Riedel, holding the small rocket, and behind him the dapper young Wernher von Braun.



After the rise of Hitler, von Braun found himself with a new circle of acquaintances, as well as a new research facility at Peenemunde.

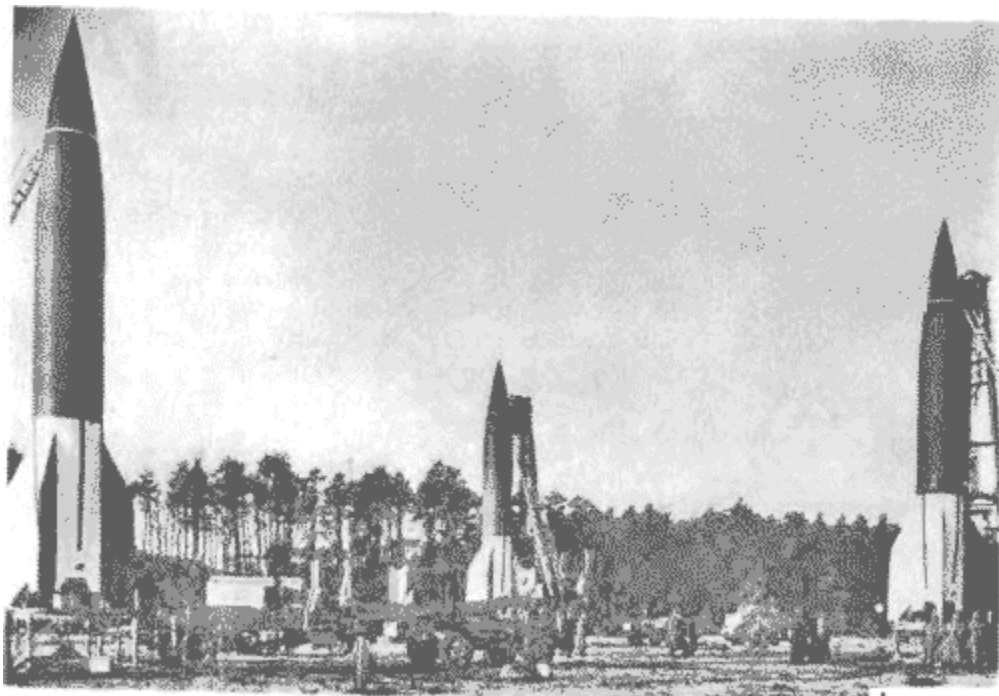

As the A-4 neared completion, the SS maneuvered to take control of the weapon from the German Army. Below, an obviously impressed Heinrich Himmler, standing next to Walter Dornberger, makes his first visit to Peenemiinde in April 1943. A vast factory complex called the Mittelwerk was constructed in the Harz Mountains to conceal and protect rocket production from Allied bombers. Below, a view of one of the underground galleries. Allied intelligence was able to identify the "ski sites" originally designed to launch the V-1. While Operation Crossbow unleashed thousands of bombers against the sites, the Germans meanwhile switched to more flexible, and inconspicuous, launch methods.

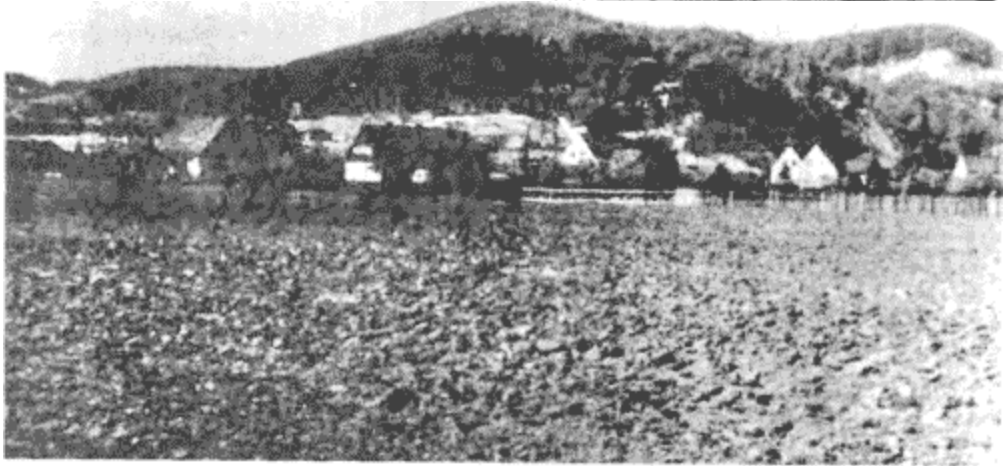

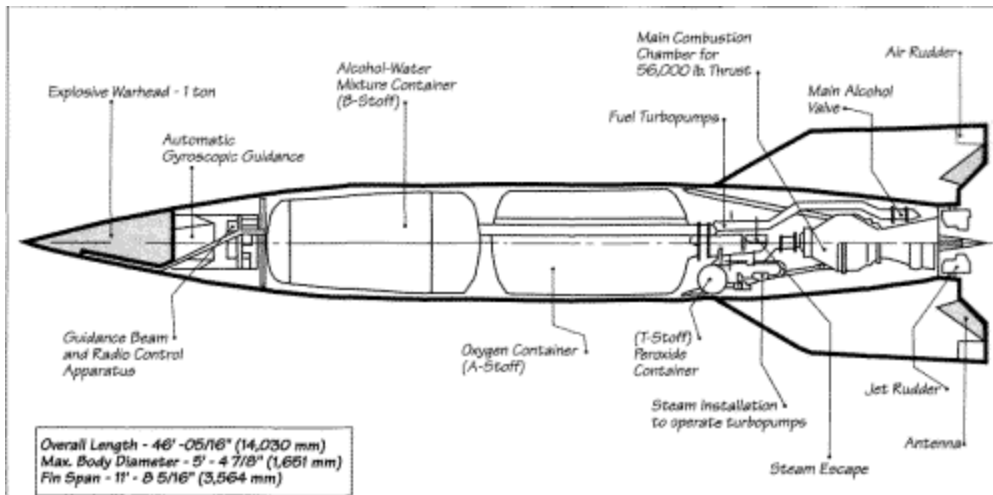

The gigantic V-2 storage bunker at Wizernes, France after absorbing 14 Allied air attacks. Today the bunker is a museum run by the French government called La Coupole. It contains originals of the V-1 and V-2 and also celebrates space travel. Carefully considered German camouflage schemes were designed to conceal the weapons among trees.



## [Index](#)

### CHAPTER ONE:

## THE SITUATION WITHIN NAZI GERMANY

Thanks to the American media and what passes for history, most Americans have no idea of wartime conditions within Germany. The topics most germane to this discussion are the means of wartime industrial production and transportation within Germany.

After the Battle of Britain, Germany's air domination over Europe began to decline, sliding down a slippery slope which ultimately resulted in one major reason for its defeat. German means of industrial, arms, and energy production became increasingly vulnerable to attack by Allied bombers. The munitions plants needed to produce the arms to maintain the war effort, such as tanks, airplanes and cannons were all targets of Allied air bombardment. Likewise, high priority targets included oil production and refining facilities which produced the fuel and lubricants needed to make the war effort possible.

One way Germany responded to air attacks was by moving munitions facilities and high-value industrial plants underground (1). Some of these facilities were vast, encompassing miles of underground tunnels. They housed both the industrial means of war production and the workers themselves. The facilities at Nordhausen in Thuringia are well known as the site of production for the V-1 and V-2, but there were others. The newly discovered underground complexes of the Jonas Valley south of Nordhausen in Thuringia constitute another vast complex (2)(3). This facility was to serve as a center of government and most probably a research center for advanced weaponry. This is also true for the many

underground complexes in what is now Poland. Notable among these is a facility called "Der Riese" (The Giant). Der Riese served as a uranium mine, uranium processing facility, and research and development facility for secret weapons (4). Underground facilities for weapons production were found throughout Germany, Austria, Czechoslovakia and Poland. Underground production facilities were also set up to refine synthetic petroleum products from coal and to generate electricity.

In addition to underground facilities, camouflage was used to hide numerous smaller facilities. These many camouflaged and underground plants formed a web of sub-assembly producers. Each sub-assembly facility sent their product to a larger or a more centrally located facility for further work. From there it might be transported again for final assembly. As an example, type XXI U-boats were modular, being produced in pipe-like sections throughout Germany. They were transported by rail to sites near the North Sea and only finally assembled at water's edge. Likewise, some types of aircraft were only finally assembled near the runway.

Further confusing Allied air intelligence, the plants were constantly moving. Eventually everything of value was to be moved underground, to bomb-proof shelters. Facilities were kept on the move until space was available for this underground re-location. These tactics worked for the Germans. There were simply too many moving targets for the Allies to completely stop German war production.

Of course the weak link in this scheme was transportation. The railroad system was the only practical and most energy efficient method of moving all these sub-assemblies. Trucking material was done but in a petroleum-starved Third Reich, it was not possible to sustain a truck-based transportation system necessary to meet all the requirements of wartime Germany. Recognizing this, the Allies bombed railroad centers using the heavy, four-engine B-17 bombers.

By mid-1943 the American P-51 Mustang was introduced into the field of play. This aircraft could be thought of as a Spitfire which could fly for eight hours. Its range allowed it to escort Allied bombers to their targets throughout the Reich. After escorting the bombers to their targets the P-51s were released to attack "targets of opportunity". A P-51 can fly close to the ground and attack individual trains, which they did. Perhaps you will recall the many wartime film clips showing these P-51s destroying German trains as they traveled. By mid-1944, it is a wonder that any trains within Germany could move at all. Some were forced to hide in mountain tunnels, as they did near the Jonas Valley, running at night or when there were no enemy aircraft reported.

As a result of these day and night air attacks, Germany found itself increasingly the victim of shortages of material and fuel, limiting its ability to make war.

Though Germany's air defense system was the best of any warring nation, it was clear that if Germany was to survive, improvement was imperative. Germany experimented with radically new types of air defense systems. Anti-aircraft rockets, guided both from the ground and by infra-red homing devices were invented. Vortex cannons, sun cannons, air-explosive turbulence bombs, rockets trailing long wire to ensnare enemy propellers, numerous electronic jamming devices, electronic devices designed to stop ignition-based engines, magnetically repulsed projectile sand long-range x-ray "death rays" were all under development as the conflict ended (5) (6). Among these exotic solutions were saucer-shaped interceptor aircraft.

The Germans already had jet and rocket interceptors as well as jet and rocket attack vehicles. German skies were full of these and other exotic aircraft so this new saucer shape was not considered as important then as we do today looking back upon it from a UFO perspective. To the German military and civilians alike these were just more new weapons.

The "Alpenfestung"

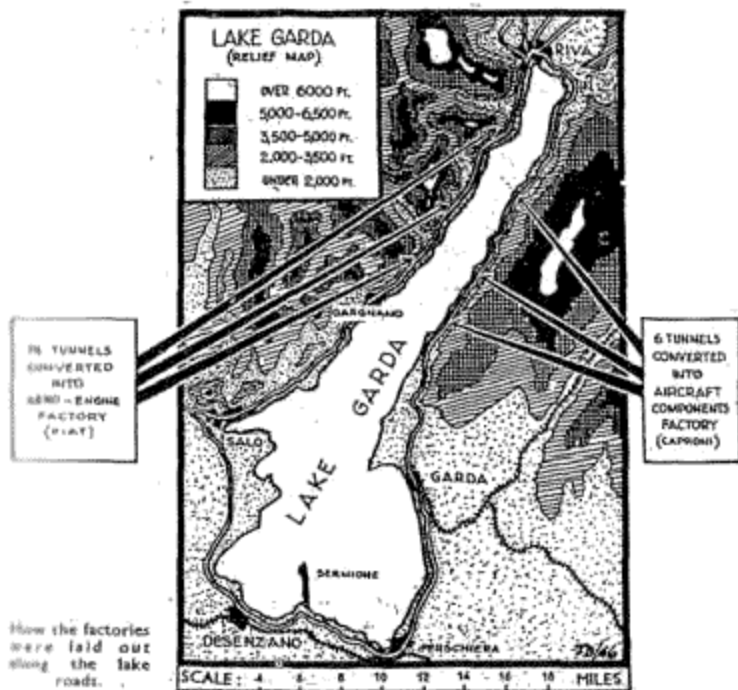

FOR THE LAST STAND.—The "Redoubt" area planned by the Germans.

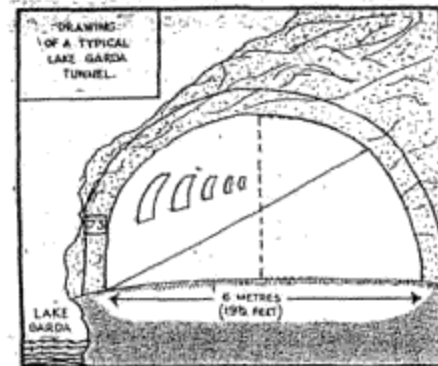

From top to bottom, right to left are: The "Alpenfestung" which was the southernmost island of defense planned by the Germans; Diagram of the Fiat underground facility at Lake Garda in Northern Italy which worked under direction of the Germans; A cross section of the tunnel. It was in this facility where Renato Vesco worked during the Second World War.

As the conflict drew to its conclusion, military planners in Germany considered the idea of concentrating their ground and air defenses into specific fortresses for a last stand. This would buy them time. They needed time to perfect new "Siegerswaffen", super-weapons so powerful that they could turn the course of the war for Germany by themselves.

A mountain fortress or "Alpenfestung" was to be set up in the German held areas of Northern Italy, Austria and Germany in roughly the areas in which these countries converged with each other and Switzerland (7). A fortress was to be set up in the Harz Mountains of Thuringia including several large underground complexes. This would extend from Nordhausen in the north down through Kahla and into the Jonas Valley. Another similar fortress complex was scheduled for the Owl Mountains separating Poland from Czechoslovakia including "Der Riese" mentioned earlier (8). Another fortress was to be set up in the Black Forest of Southern Germany. Other minor islands of resistance were to be set up in Norway, the Bohemian forest and the Bavarian forest (9).

These fortifications were to house soldiers, mostly SS units. They would also provide underground hangers and bomb-proof overhangs for aircraft take-offs and landings. Missiles, such as the V-1 and V-2, and other weapons were to be mass produced there and fired automatically, right off the automated assembly line. The exotic weaponry mentioned above was to be employed, along with especially trained mountain troops, defending the mountain passes into these fortresses (10).

History tells us the Alpenfestung never actually happened. It did not happen because German construction was simply not able to make these places ready in time. What is important for us to realize is that the weaponry for these fortresses was being developed as the Second World War drew to a close. Few of these weapons reached the operational stage but many were in various stages of development.

When Hitler took power in 1933 one of his first decisions was to rebuild the German Air Force, the Luftwaffe. This new organization was to make a clean break with the old and this reasoning was reflected in its research and development facilities, the RLM, which were the finest of any branch of the German military. Two brilliant research facilities were also in



the possession of the Luftwaffe, the Lilenthalgesellschaft and the Academy of Air Research. Besides the Luftwaffe, there was the Army which did develop such things as the V-1 cruise missile. There was the Speer Ministry of Arms which did research. In addition, a system of research and development facilities was setup headed by a research council, the "Reichsforschungsrat". Their job was to coordinate the technical schools and universities, the military and governmental research groups, and the research and development facilities into a concerted effort (11).

### The Underground Complex "Der Riese"

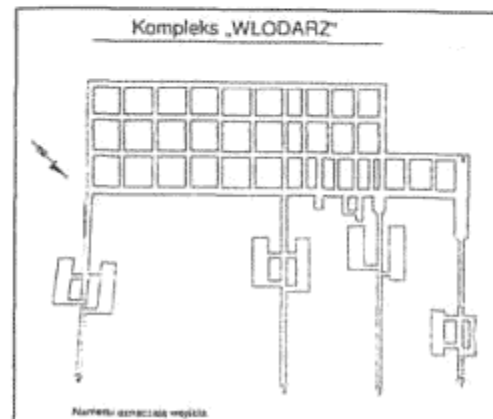
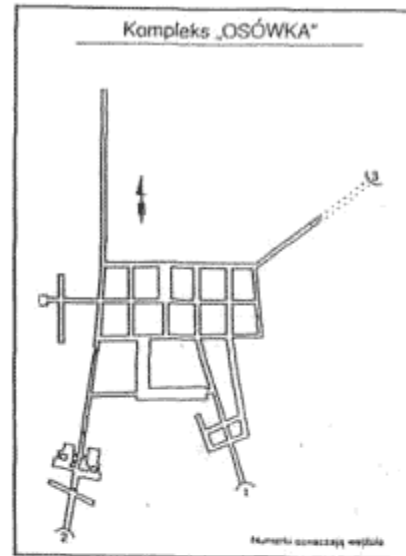

"Der Riese", ("The Giant" in English), is located in the "Gory Sowie" or Owl Mountains of modern-day Poland. It consisted of seven underground complexes which concerned themselves with the mining, refining, research and development of uranium both for energy producing machines and weapons of war. The tunnels of the larger complexes are almost two miles in length. Courtesy of Robert Lesniakiewicz. Mr. Lesniakiewicz is a Polish engineer and a member of the research group responsible for opening, exploring and mapping of "Der Riese".

Another fact that influences our story was the ascendance of the SS (Schutz Staffel). The SS began simply as Hitler's body guard. From humble beginnings it was transformed into the most powerful entity within the Third Reich after Hitler himself. The military arm of the SS, the Waffen SS, became the most elite military force in Germany. The SS also took over many research, development and production facilities from the Army and Air Force. The SS took over control of civilian research and development facilities. The SS began taking facilities and power away from Albert Speer's Ministry of Arms and the RLM headed by Hermann Goering. As the war progressed, the SS organized, built and ran many underground manufacturing facilities (12). They even appropriated the huge industrial firm, the Skoda Works, its subsidiaries and related firms, centered near Prague, for their in-house projects (13). The SS became an empire within an empire answerable only to Adolf Hitler.

The SS also set up special research facilities for politically unreliable scientists. Research projects arose within these facilities which were in part staffed by technical people drawn from the prisoner pool. Such facilities were set up at Oranienburg, Nordhausen, Mecklenburg and Mathausen (14).

As the SS rose within Germany, so did the fortunes of Doctor of Engineering, General Hans Kammler. Kammler seems to come into prominence through his talent at designing and building massive underground facilities (15). Soon Kammler was placed, by Hitler, in charge of V-weapons (Vergeltungswaffen). This means Kammler was in charge of the facilities at Peenemuende and Nordhausen. He was Dr. and General Walther Dornberger's boss who, in turn was Dr. Wernher von Braun's boss. Further, Kammler headed up an advanced research and development group, associated with the Skoda Works, called the Kammler Group (16). This group held the most advanced technical secrets of the Third Reich.

During post-war questioning, when asked for details concerning V-weaponry, Albert Speer told Allied interrogators to ask Kammler these questions (17). They never did, however, because the 42 year old General Kammler had disappeared. Kammler was no fool. Wherever he went he undoubtedly took copies of the most advanced German technology. Numerous countries would have dealt with Kammler, regardless of his past. This includes the U.S.A. Couple this with the fact that no search was ever made for General Kammler in spite of the fact that he extensively employed slave-labor in his projects.

Did Kammler do a secret deal with an Allied government, exchanging information for a new identity? Or did Kammler escape Allied clutches to some safe haven such as South America? It is known that the Nazis set up shop in large, secure tracts of land between Chile and Argentina. It is also known that UFOs were seen earlier in that region than in the USA after the war. Many post-war stories involve German scientists relocating in South American countries formerly friendly to the Nazis and there building and flying German saucers.

#### CHAPTER ONE The Situation Within Nazi Germany Sources and References

1. Vesco, Renato, 1976, Intercept UFO, pages 90-110, Pinnacle Books, 275 Madison Ave, N.Y., NY. 10016  
Reissued as Man-Made UFOs 1944-1994 by Adventures Unlimited Publishing, P.O. Box 74, Kempton, Illinois 60946
2. Zunneck, Karl-Heinz, 1998, Geheimtechnologien. Wunderwaffen Und Irdischen Facetten Des UFO-Phaenomens 50 Jahre Desinformation und die Folgen. CTT-Verlag, Suhl, Germany
3. Faeth, Harald, 1998, 1945 - Thueringens Manhattan Project Auf
4. der Spuerensuche nach der verlorenen V-Waffen-Fabrik in Deutschlands Unterarundr CTT-Verlag, Heinrich-Jung-Verlagsgesellschaft mbH, Suhl, Germany
5. Jesensky, Milos, Ph.D. and Robert Lesniakiewicz, 1998, "Wunderland" Mimoszemske Technoloaie Treti Rise. AOS Publishing, 1 Vydani
6. Luser, Rudolf, 1960, German Secret Weapons Of The Second World War. Neville Spearman, London, England
7. German Research Project, 1999, "German Death Rays Part Two: The German And American Governmental Evidence", German Research Project, P.O. Box 7, Gorman, CA. 93243-0007, USA
8. Vesco, Renato, 1976, pages 95-98
9. Jesensky, Milos, Ph.D. and Robert Lesniakiewicz, 1998, page 37
10. Vesco, Renato, 1976, page 106
11. ibid, pages 90-111
12. Combined Intelligence Objectives Subcommittee Evaluation Report 20, Planning Board Of Reich Research Council
13. Vesco, Renato, 1976, pages 90-93
14. Agoston, Tom, 1985, Blunder! How the U.S. Gave Away Nazi
15. Supersecrets To Russia , pages 12-15, Dodd, Mead & Company, New York
16. 14. British Intelligence Objectives Sub-Committee, Report Number 19
17. 142, Information Obtained From Targets Of Opportunity In The Sonthofen Area, pages 1 and 3
18. Vesco, Renato, 1976, pages 93-95
19. Agoston, Tom, 1985, page 13
20. Combined Intelligence Objectives Subcommittee Evaluation Report Number 53(b), Interrogation of Albert Speer, Former Reich Minister of Armaments, page 3

Some of the earliest forms of UFOs, reported during the 1940s, were the ball of light phenomena known as 'foo fighters,' as depicted here.

Walter Dornberger, Wernher von Braun (in cast) and other scientists after surrendering to the U.S. Seventh Army in May 1945.



Below, in May 1946, the Americans fire off a captured V-2 at the White Sands proving ground in New Mexico.

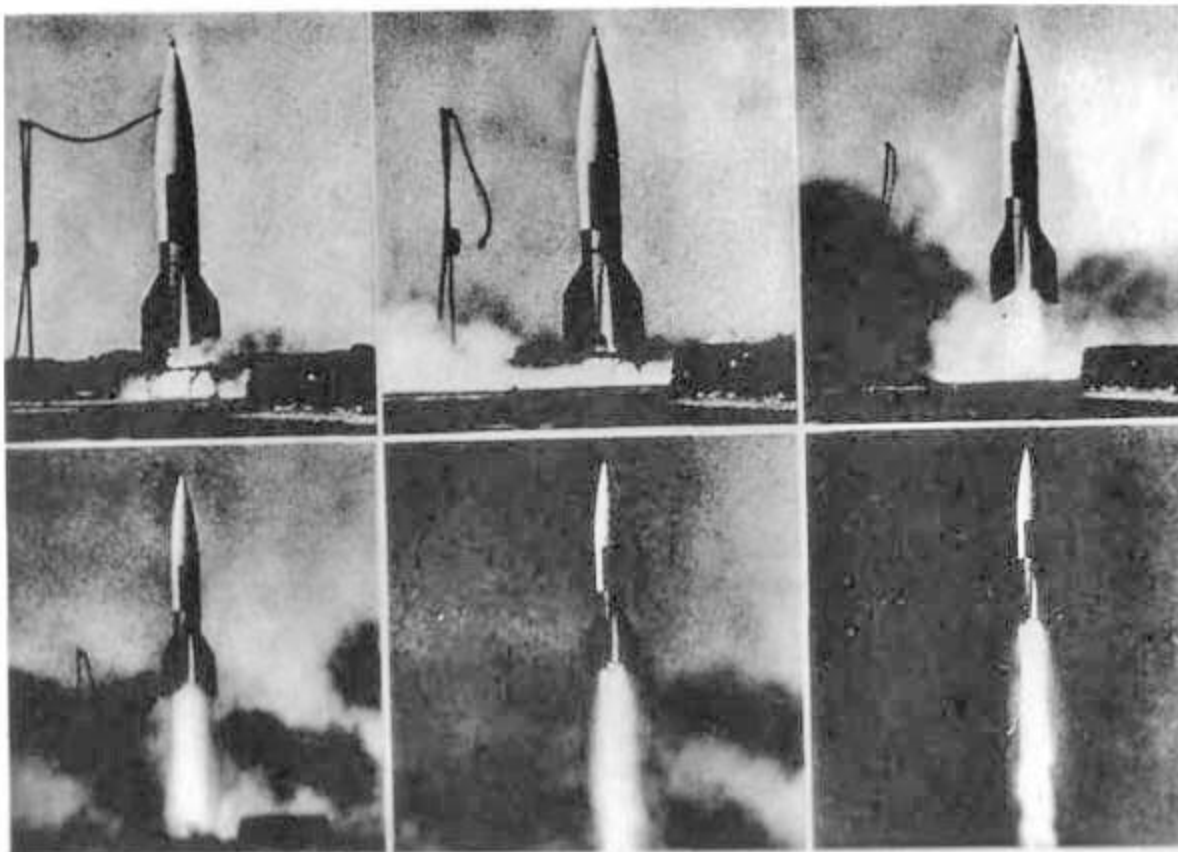

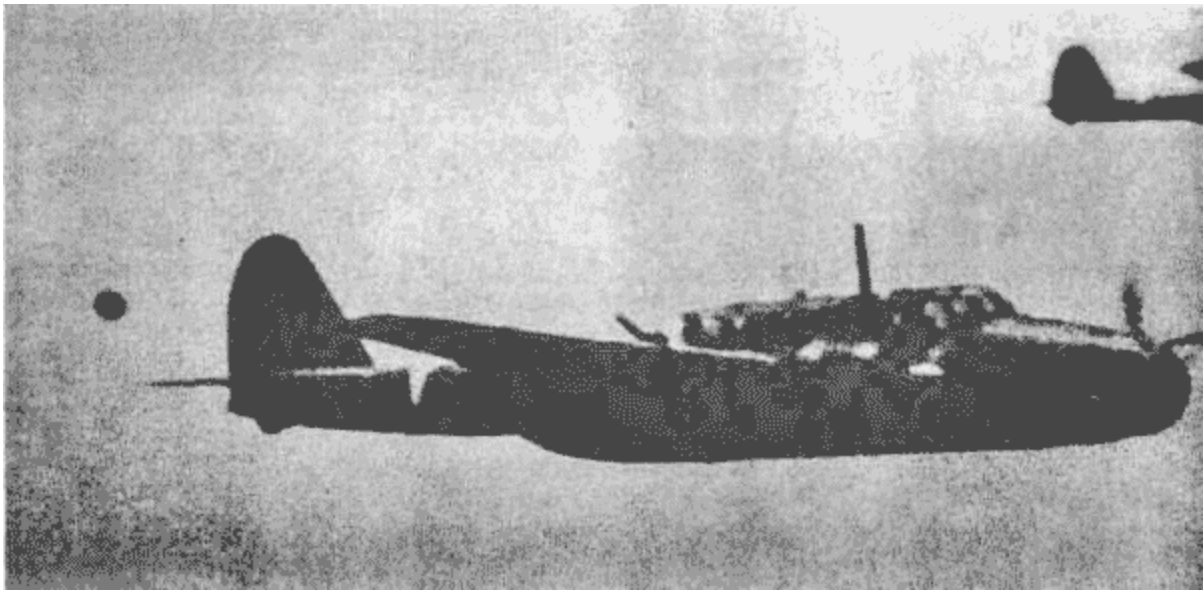
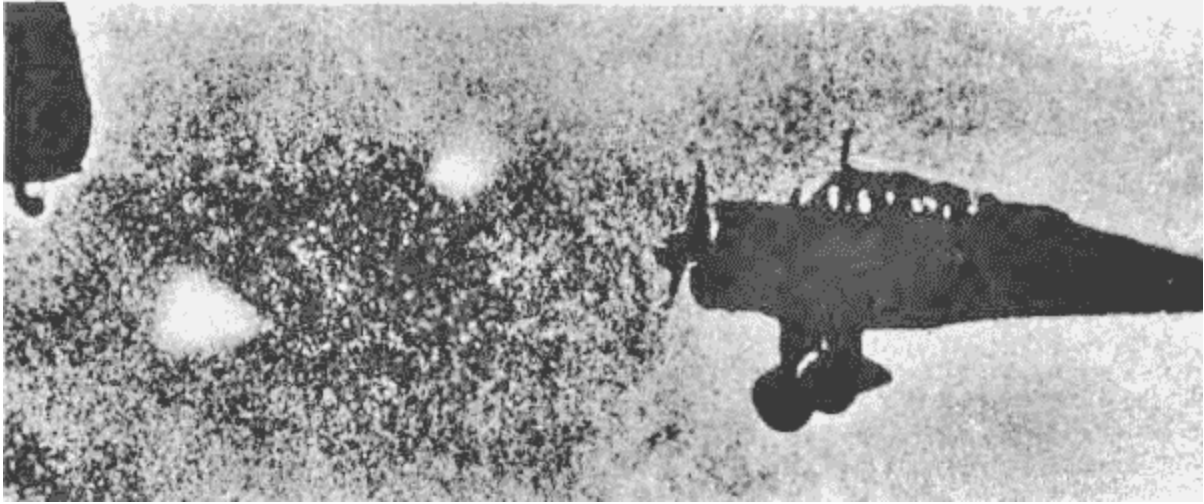

**Above: Few photos of foo fighters are currently known. The top photo is one of the most famous, taken over Europe; the bottom was taken over the Sea of Japan between Japan and Korea in 1943.**

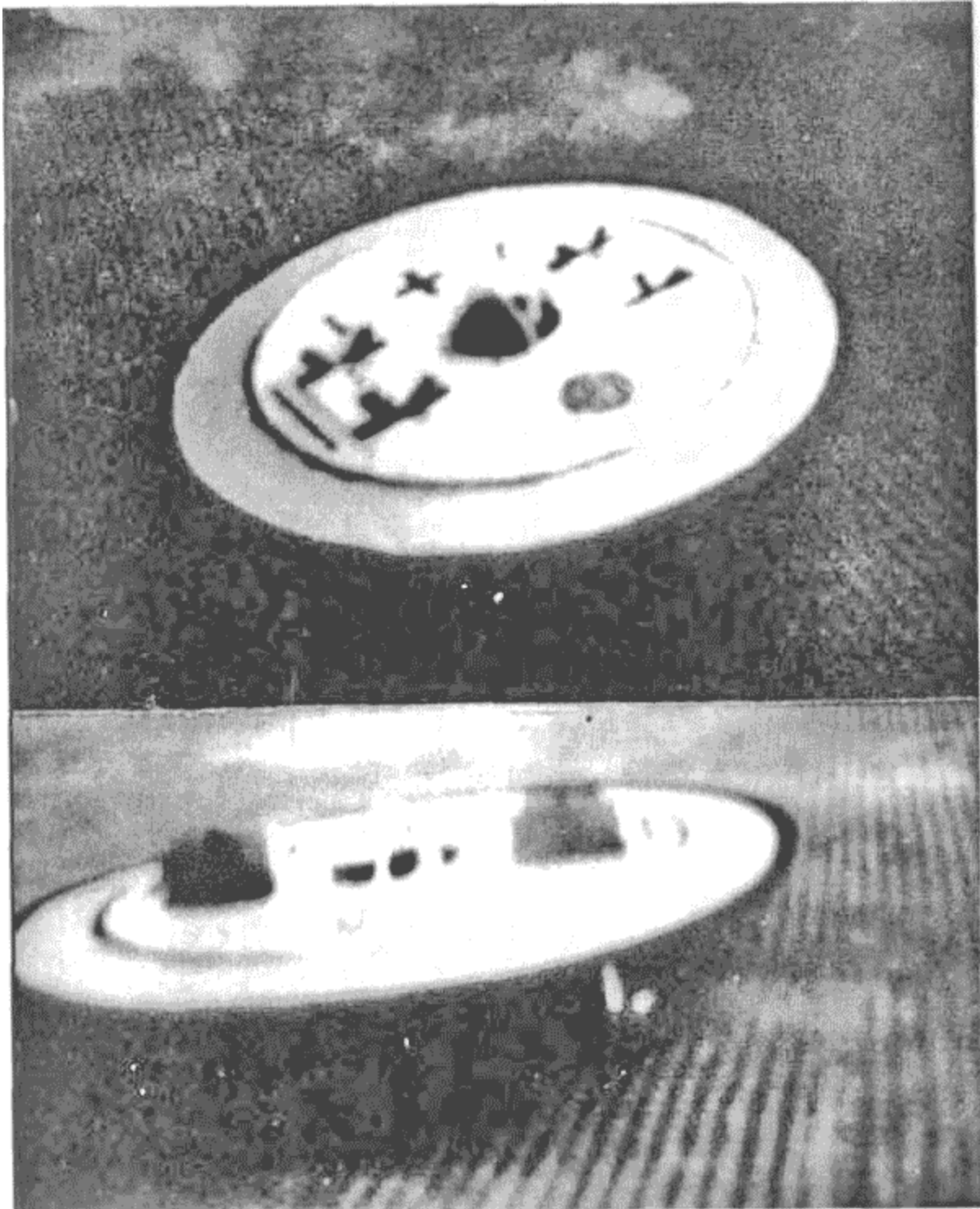

Above: Rare photos allegedly of an early experimental saucer at the Peenemuende Space Center.

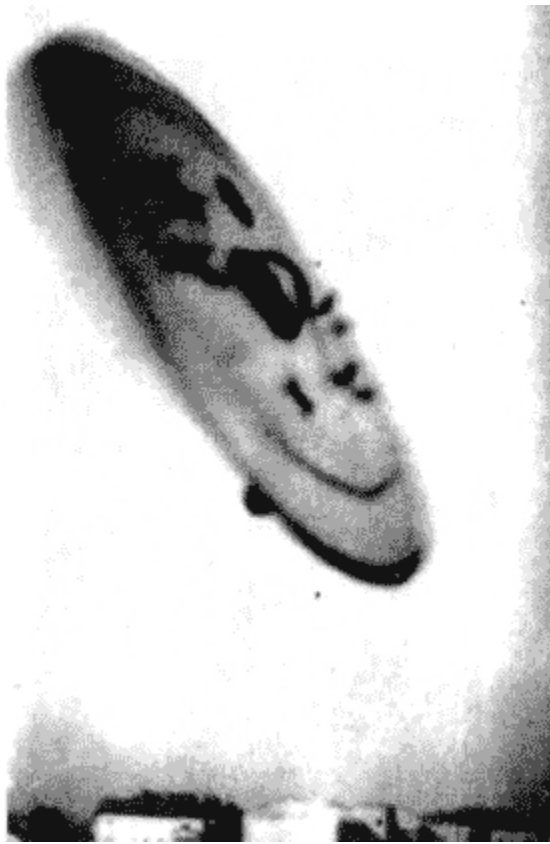

Left: Rare photo allegedly of an early experimental saucer at the Peenemuende Space Center in flight.

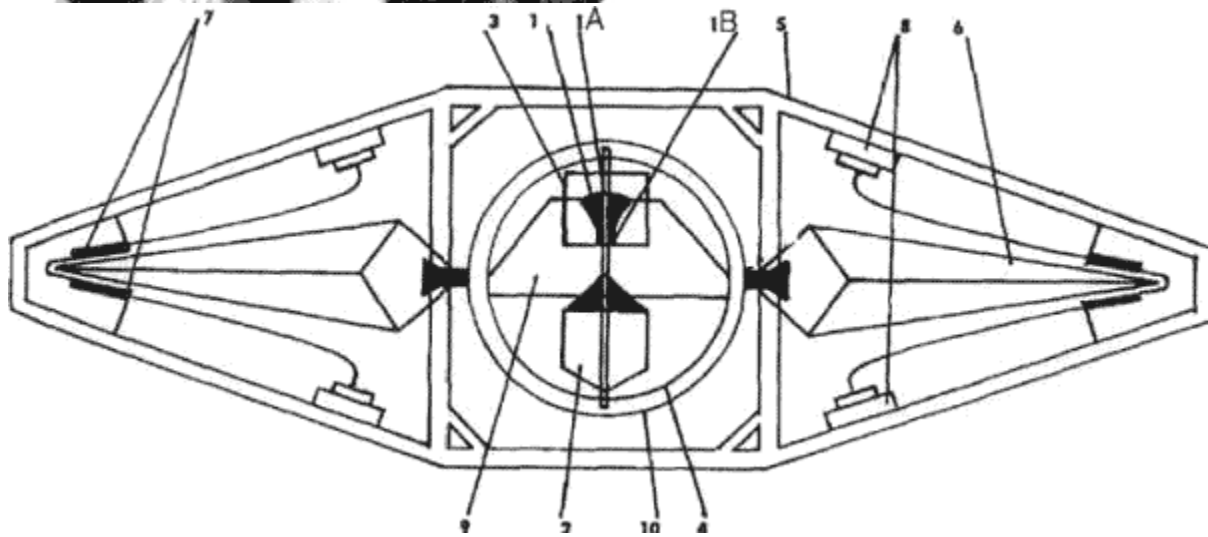

Above: Internal plans for a "Vril-1" saucer, according to Polish historian Igor Witkowski.

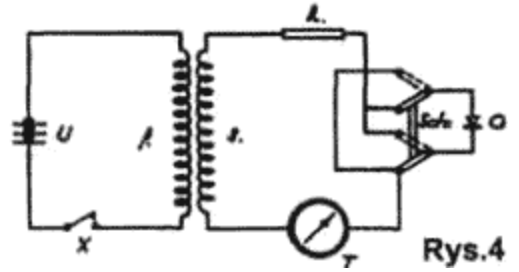
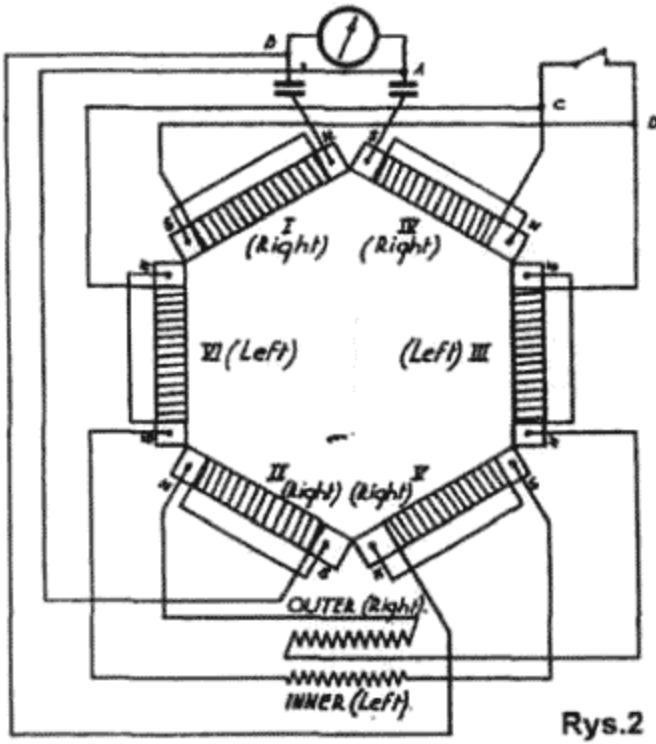
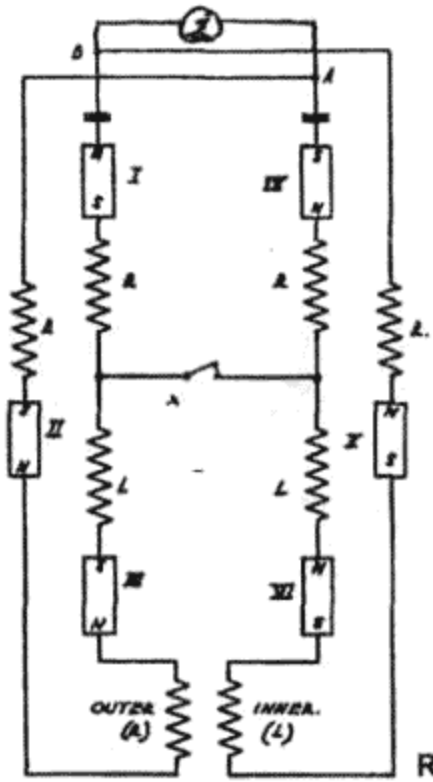
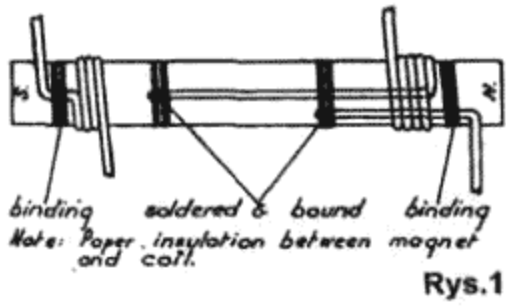

Patent for the Coler Converter, a free energy device designed by Hans Coler in 1937.

CENTRAL INTELLIGENCE AGENCY  
INFORMATION FROM  
FOREIGN DOCUMENTS OR RADIO BROADCASTS

REPORT NO. OO-V-27452  
CD NO. ---

COUNTRY: Germany, USSR, French Equatorial Africa, Syria, Iran  
 SUBJECT: Military - Unconventional aircraft  
 DATE OF INFORMATION: 1952 - 1

HOW PUBLISHED: Daily, thrice-weekly newspapers  
 DATE DIST. 18 Aug 1952

WHERE PUBLISHED: Athens, Brazzaville, Tehran

DATE PUBLISHED: 11 Mar - 20 May 1953

LANGUAGE: Greek, French, Persian

CENTRAL INTELLIGENCE AGENCY  
CLASSIFICATION 3  
 Canceled  
 Deleted  
 BY AUTHORITY: [redacted] SUPPLEMENT TO REPORT NO. [redacted]  
 Name: [redacted]  
 Office: [redacted]  
 Date: 16 MAR 1955  
 THIS IS UNEVALUATED INFORMATION

[redacted]

SOURCE: Newspapers as indicated.

ENGINEER CLAIMS "SAUCER" PLANS ARE IN SOVIET HANDS;  
SIGHTINGS IN AFRICA, IRAN, SYRIA

GERMAN ENGINEER STATES SOVIETS HAVE GERMAN FLYING SAUCER EXPERTS AND PLANS --  
Athens, 1 Vradnyi, 13 May 53

Vienna (Special Service) -- According to recent reports from Toronto, a number of Canadian Air Force engineers are engaged in the construction of a "flying saucer" to be used as a future weapon of war. The work of these engineers is being carried out in great secrecy at the A. B. Roe Company (transliteration from the Greek) factories.

"Flying saucers" have been known to be an actuality since the possibility of their construction was proven in plans drawn up by German engineers toward the end of World War II.

Georg Klein, a German engineer, stated recently that though many people believe the "flying saucers" to be a postwar development, they were actually in the planning stage in German aircraft factories as early as 1941.

Klein said that he was an engineer in the Ministry of Speer (probably refers to Albert Speer, who, in 1942, was Minister for Armament and Ammunition for the Third Reich) and was present in Prague on 14 February 1945, at the first experimental flight of a "flying saucer."

During the experiment, Klein reported, the "flying saucer" reached --  
meters within                      es and --

A C.I.A. document dated August 18, 1952 mentioning that the Germans were building "flying saucers" as early as 1941. From the German book Die Dunkle Seite Des Mondes (The Dark Side of the Moon) by Brad Harris (1996, Pandora Books, Germany).

[Index](#)

## CHAPTER TWO: RELIABLE SOURCES

Much has recently been written concerning German flying discs. To the best of my knowledge, no single source has all the answers. To piece this puzzle together information from various sources must be used. Of course, some sources are better than others. Categories of sources, in a somewhat descending order of reliability are:



1. Those actually involved with these projects.
2. Witnesses of flying saucers who had prior knowledge that the sighting was of a German saucer as opposed to an unidentified flying object.
3. Those who at the time had good reason to know of Germans saucers.
4. Third-party intelligence sources which verify claims made by the higher categories above.
5. Researchers who have interviewed principals involved in German saucer research.
6. Studies or scientific papers published by individuals identified

Sources without names are not as good as sources with names. Information, data, or pictures without a "chain of evidence" linking them to the event are not as good as those with proper documentation.

After almost sixty years, nothing is going to be perfect. These categories are not meant to be absolute. Some sources fit into multiple categories. Some reports have value even though they are not rigorous simply because they were later corroborated by other sources.

When reading allegedly factual statements, the reader should always be looking for the source documentation for these statements. A writer's opinion or interpretation may be valuable but it should always be made clear which is who.

Examples of the first category are those who worked on German saucer projects:

Among these is Rudolf Schriever. Schriever was involved in a German saucers project which sometimes bears his name. As a source of information, he wrote an article on German saucers for the very respected *Der Spiegel* magazine (1).

Likewise, Joseph Andreas Epp was a self-admitted consultant for both the Schriever-Habermohl project at Prag and the Mietheproject in Dresden and Breslau. Mr. Epp wrote to me personally (2) and has written several articles and a book about German saucers before he died in 1997 (3).

An example of a witness who had prior knowledge of German saucers would be Georg Klein. Klein was an engineer, an eyewitness to a saucer lift-off on February 14, 1945. He was also Special Commissioner in the Ministry of Arms Production who oversaw both the Schriever-Habermohl and Miethé-Belluzzo projects for Albert Speer. Mr. Klein has written some newspaper articles about these facts such as his article in *Welt am Sonntag*, titled "Erste "Flugscheibe" flog 1945 in Prag" (The First Flying Disc flew in Prague in 1945)(4) . Other newspaper references of Mr. Klein will be mentioned. He has also written under the pen-name of Georg Sautier.

Another example would be the unnamed eyewitness provided by researcher Horst Schuppmann and first reported in Karl-Heinz Zunnack's book *Geheimtechnologien. Wunderwaffen Und Irdischen Facetten Des UFO-Phaenomens* (Secret Technology, Wonder-weapons and the Terrestrial Facts of the UFO Phenomenon). In this report the informant relates a wartime experience in which he witnessed several small flying saucers in a hangar (5).

George Lusar is an example of a source falling under category three. Lusar worked for the German Patent Office during World War Two. He saw many secret patents as they came into his office. After the War he wrote a book and some articles concerning this technology which was taken by the Allies (6).

Likewise, Italian engineer Renato Vesco worked with Germans while at a secret division of Fiat housed in an underground facility on Lake Garda, right in the middle of the proposed Alpenfestung. After the war, Vesco also researched British Intelligence data. This data was voluminous. Of course, Vesco knew what to look for based upon what he had learned while working in a secret Axis underground facility. Vesco is an example of category three and the next one, category four.

Category four involves intelligence information obtained from governmental sources. This information mostly comes from the very entities who are trying to suppress this information. It should always be suspect. It should be used only to verify information obtained from higher sources (categories 1 through 3) or from governmental sources of another government. For instance, information concerning flying objects which Renato Vesco called "Fireballs" was verified using information obtained from the U.S. government under laws forcing it to divulge some types of information (Freedom Of Information Act) (7).

Category five would include, for instance, Callum Coats whom spent three years with mathematician and physicist, Walter Schauburger, son of Viktor Schauburger. Mr. Coats consequently learned a great deal of information concerning the ideas

of Viktor Schauberger. Mr. Coats is a scientist and architect. Coats wrote *Living Energies* about the ideas of Schauberger and his saucer models (8).

In the same category we find Michael X. Barton, who, through a translator, Carl F. Mayer, received information from an informant in German, Hermann Klaas, who claimed to have actually been involved with some of the German saucer projects. Klaas' peripheral knowledge (category three) also seems to have extended into other aspects of secret German research and technology. Barton wrote one of the earliest books on this topic, *The German Saucer Story* in 1968 (9).

One unique source is Wilhelm Landig. Landig wrote three novels dealing with the Second World War. Following the title of each novel, Landig tells the reader that this is a "novel based on realities". The reader is given to understand that the technology described was based on hard fact. Landig's works contain more than cold facts, however. Landig deals with a large variety of topics in his books. Sometimes facts or opinions are stated or "stories behind the story" are told. He writes, unashamedly, from the National Socialist perspective. Landig was obviously a Nazi and an intellectual insider. His history always remained unclear, at least to this writer, until his recent death. Because of his unclear background and the fact that he wrote in novel form, there has been a reluctance to ascribe full creditability to the statements he makes regarding the technology of the Third Reich.

This all changed in 1999 as a result of research done by Margret Chatwin with an organization called "Informations dienst gegen Rechtsextremismus" (Information service against the extreme right) (10). Coming in from this perspective, they, certainly, would not be accused of aggrandizing Landig's career. Some details of Landig's biography are now filled in. In that article we learn that Landig, an Austrian, took part in the unsuccessful Vienna Putsch of 1934. Thereafter, he fled to Germany and was inducted into the SD, the SS and the Waffen SS. There he rose to the rank of "Oberschafuehrer". Eventually, Landig was detailed to oversee government security concerns and given a position in the Reichs Security Department. Landig, in this position, was assigned to cover the security for the development of "UFOs" (11). It turns out that Landig was not only a source but a great source concerning the development of German saucers.

## **CHAPTER TWO**

### **Reliable Sources**

#### **Sources and References**

1. Der Spiegel, March 30, 1959, Article and interview of Rudolf Schriever
2. Epp, Joseph Andreas, telephone communication and personal letters
3. Epp, Joseph Andreas, 1994, *Die Realitaet der Flugscheiben Ein Leben fuer eine Idee*, EFODON e. V., c/o Gernot L. Geise, Zoepfstrasse 8, D-82405 Wessobrunn, Germany
4. Klein, Georg, in *Welt Am Sonntag*, 4/26/53, "Erste Flugscheibe Flog 1945 in Prag"
5. Zunneck, Karl-Heinz, 1998, pages 120-122
6. Lusak, Rudolf, 1960, *German Secret Weapons Of The Second World War*, Neville Spearman, London
7. Headquarters, United States Strategic Air Forces In Europe, Office Of The Director Of Intelligence, 1944, report titled: "An Evaluation Of German Capabilities In 1945"
8. Coats, Callum, 1996, *Living Energies*. National Book Network, 4720 Boston Way, Lanham, MD. 20706
9. Barton, Michael X., 1968, *The German Saucer Story*. Futura Press, 5949 Gregory Ave., Los Angeles, CA. 90038
10. Chatwin, Margret, 1999, page 1, , Ahnenerbe, Ufos, Neo nazis: Wilhelm Landig, Informationsdienst gegen Rechtsextremismus, <http://www.idgr.de/texte-1/esoterik/landig/landig.html>
11. *ibid*

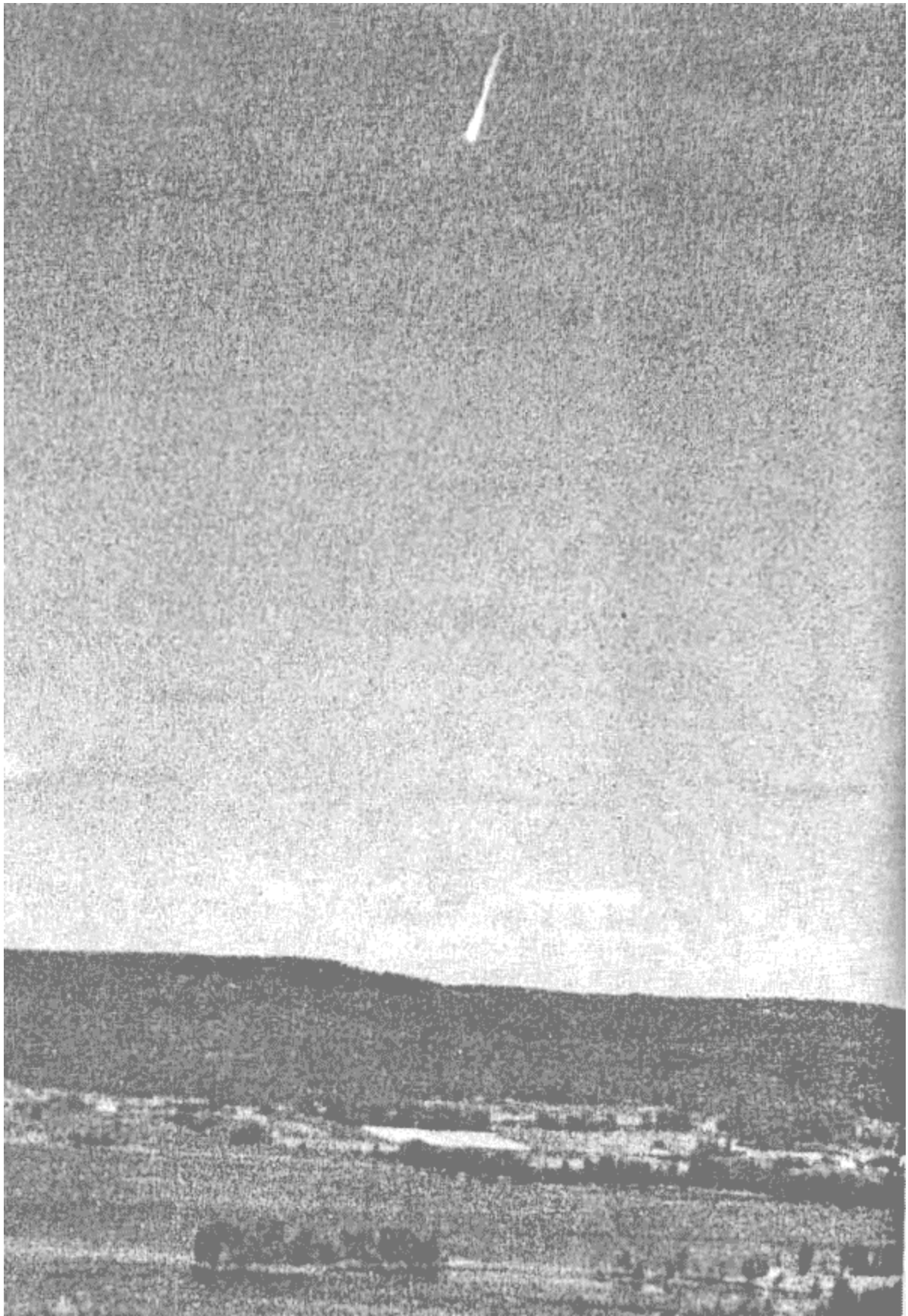

Office Memorandum • UNITED STATES GOVERNMENT

TO : MOP - Mr. Morgan  
FROM : COH - Mr. Lyon  
SUBJECT:

DATE: September 4, 1946

**TOP SECRET**



FW 811-20200 FAMILY/8-2946

TOP SECRET

Jack:

The following is the text of telegram no. 1538 dated August 29 from our Legation at Stockholm:

"Depts 1398, August 27.

"While over 800 reports have been received and new reports come daily, Sweden still have no tangible evidence. Full details of reports thus far received have been forwarded to Washington by our Military and Naval Attaches. My own source personally convinced some foreign power is actually experimenting over Sweden and he guesses it is Russia. He has promised to notify me before anyone else if anything tangible should be discovered."

*Munch*

A/JT

FW 811-20200/8-2946

**TOP SECRET FILE**

14  
Class sheet Made

CON:FBL:er

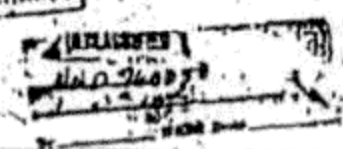

**A September, 1946 Top Secret Memorandum on Ghost Rockets.**

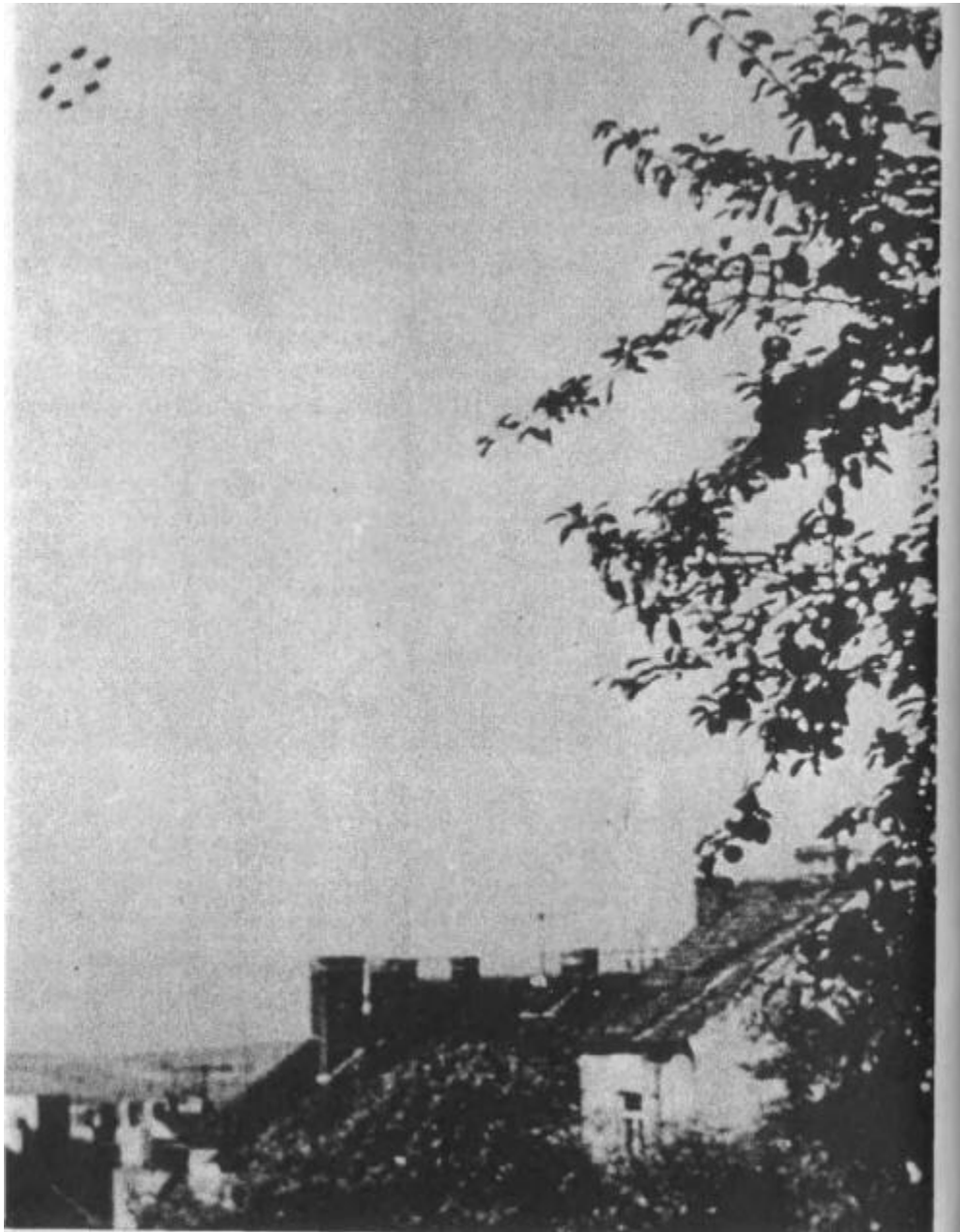

**The above photo, showing six saucers in formation, was given to Dr. J. Allen Hynek in the early 1950s by the director of the Ondrejov Observatory in Czechoslovakia. No details of the sighting are available, but the photo is thought to have been taken near Prague, perhaps during WWII.**

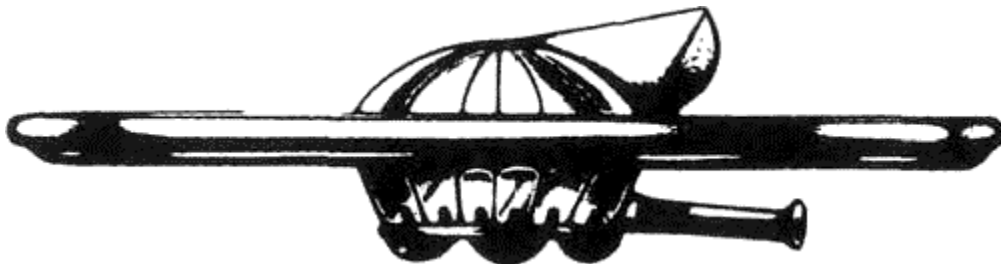

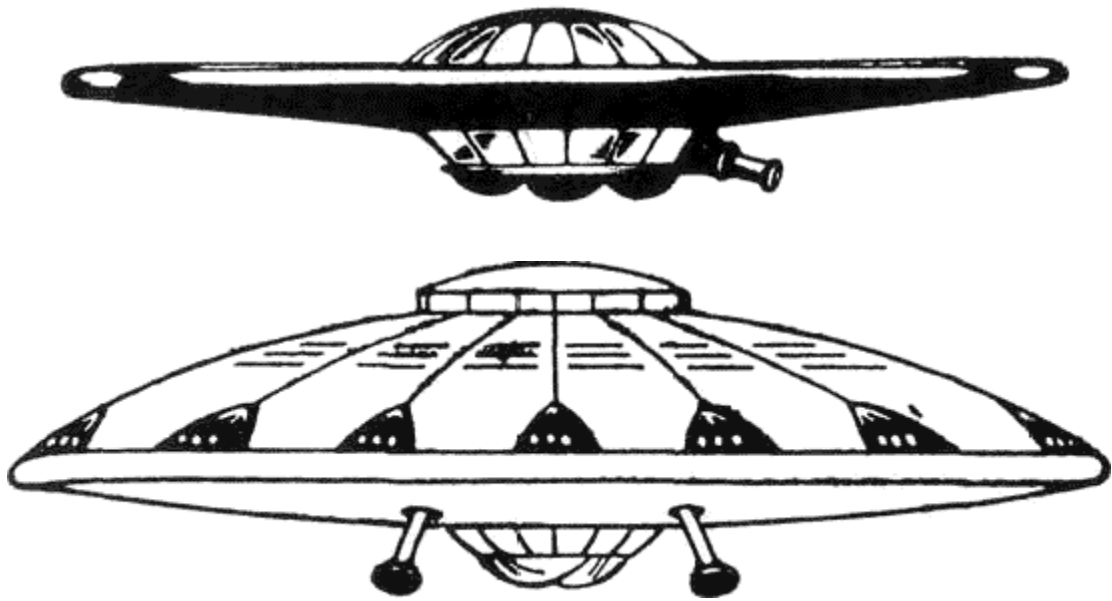

Above: Drawings of the Project Saucer craft designed in 1941 by Rudolf Schriever, a Luftwaffe aeronautical engineer, and his three colleagues, Habermohl, Miethe and Bellonzo. The first prototype was flown in June 1942 and larger versions were apparently designed and manufactured at the BMW factory near Prague, Czech Republic.



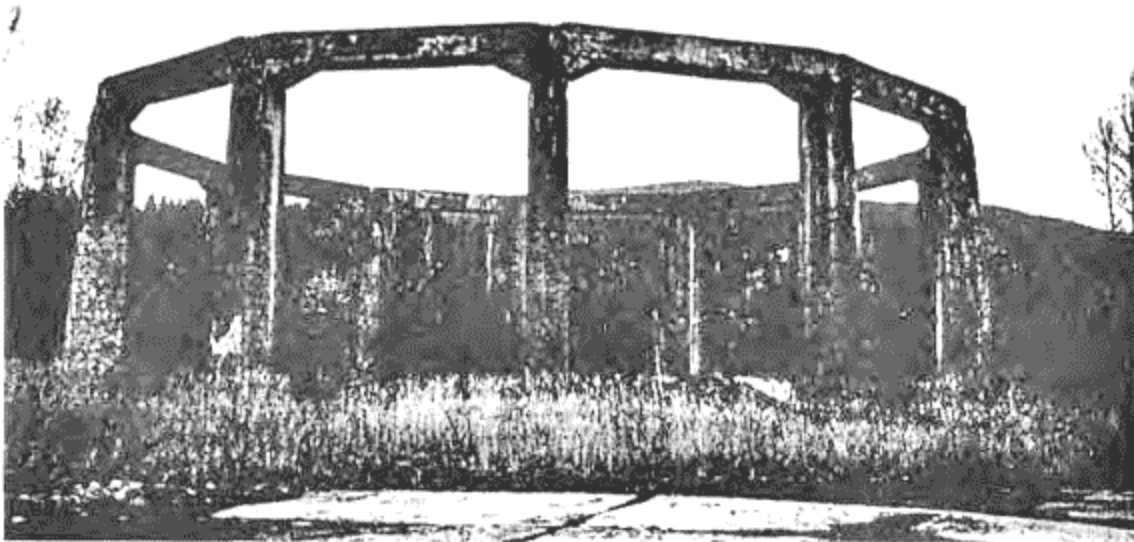

Above: The circular "Mucholapka" building in Poland. According to Polish Military Historian Igor Witkowski it was used for testing saucer-type craft.

[Index](#)

**CHAPTER THREE:**

## **AN OVERVIEW OF THE GERMAN CONVENTIONAL SAUCER PROJECTS**

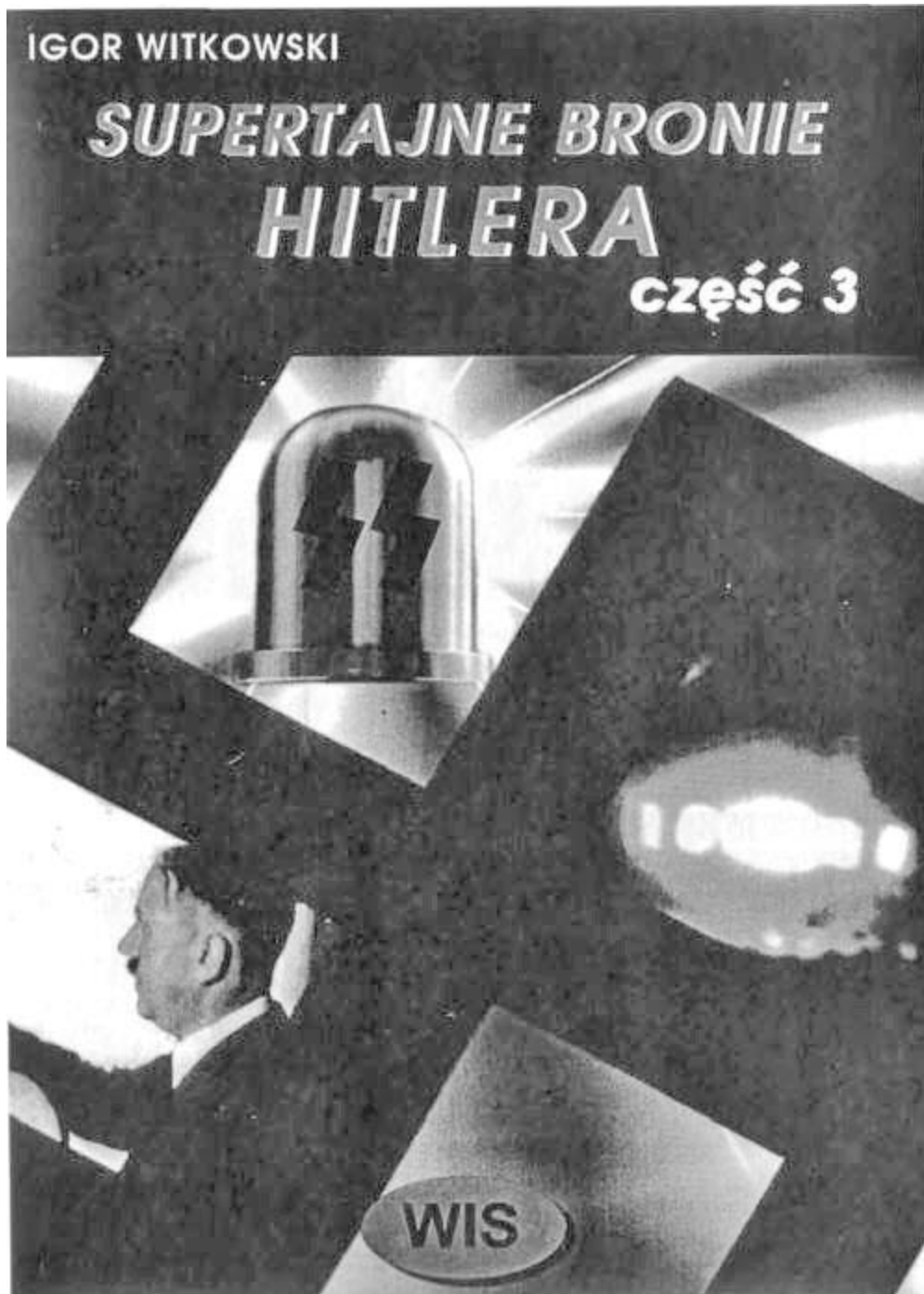

- [THE SCHREIVER-HABERMOHL PROJECT\(S\)](#)
- [THE MIETHE-BELLUZZO PROJECT](#)
- [FOO FIGHTERS](#)
- [THE PEENEMUENDE SAUCER PROJECT](#)
- [CHAPTER SUMMARY](#)

**In this section we will progress from saucer projects with area bsolutely factual and of which detail is known and proceed to projects which are less known.**

Several types of flying craft we would call flying saucers were built by the Germans during the Second World War. The exact number is still open for debate but it certainly must vary from between three to seven or possibly eight different types. These different types do not mean experimental models or variants of which there were many. What is meant here is that there were very different lines of flying machines being built in wartime Germany at different places by different groups of people. Since more than one saucer-type may have been produced by a single group, we will review this data group by group. We will progress from saucer projects which are factually better known and which deal in conventional



propulsion methods and then move to lesser known projects which deal in more exotic propulsion methods which are less well documented and so more controversial.

## [Index](#)

### **The Schriever-Habermohl Project(s)**

The best known of these projects is usually referred to as the Schriever-Habermohl project although it is by no means clear that these were the individuals in charge of the project. Rudolf Schriever was an engineer and test pilot. Less is known about Otto Habermohl but certainly he was an engineer. This project was centered in Prag, at the Prag-Gbell airport (1)(2). Actual construction work began somewhere between 1941 and 1943 (3)(4). This was originally a Luftwaffe project which received technical assistance from the Skoda Works at Prag and at a Skoda division at Letov (5) and perhaps elsewhere (6). Other firms participating in the project according to Epp were the Junkers firm at Oscheben and Bemburg, the Wilhelm Gustloff firm at Weimar and the Kieler Leichtbau at Neubrandenburg (7). This project started as a project of the Luftwaffe, sponsored by second-in-command, Ernst Udet. It then fell under the control of Speer's Armament Ministry at which time it was administered by engineer Georg Klein. Finally, probably sometime in 1944, this project came under the control of the SS, specifically under the purview of General Hans Kammler (8).

According to his own words, Georg Klein saw this device fly on February 14, 1945 (9). This may have been the first official flight, but it was not the first flight made by this device. According to one witness, a saucer flight occurred as early as August or September of 1943 at this facility. The eyewitness was in flight-training at the Prag-Gbell facility when he saw a short test flight of such a device. He states that the saucer was 5 to 6 meters in diameter (about 15 to 18 feet in diameter) and about as tall as a man, with an outer border of 30-40 centimeters. It was "aluminum" in color and rested on four thin, long legs. The flight distance observed was about 300 meters at low level of one meter in altitude. The witness was 200 meters from the event and one of many students there at the time (10).

Joseph Andreas Epp, an engineer who served as a consultant to both the Schriever-Habermohl and the Miethe-Belluzzo projects, states that fifteen prototypes were built in all (11) (12). The final device associated with Schriever-Habermohl is described by engineer Rudolf Lusar who worked in the German Patent Office, as a central cockpit surrounded by rotating adjustable wing-vanes forming a circle. The vanes were held together by a band at the outer edge of the wheel-like device. The pitch of the vanes could be adjusted so that during take off more lift was generated by increasing their angle from a more horizontal setting. In level flight the angle would be adjusted to a smaller angle. This is similar to the way helicopter rotors operate. The wing-vanes were to be set in rotation by small rockets placed around the rim like a pinwheel. Once rotational speed was sufficient, lift-off was achieved. After the craft had risen to some height the horizontal jets or rockets were ignited and the small rockets shut off (13). After this the wing-blades would be allowed to rotate freely as the saucer moved forward as in an auto-gyrocopter. In all probability, the wing-blades speed, and so their lifting value, could also be increased by directing the adjustable horizontal jets slightly upwards to engage the blades, thus spinning them faster at the digression of the pilot.

### **The Airport at Prag-Gbell**

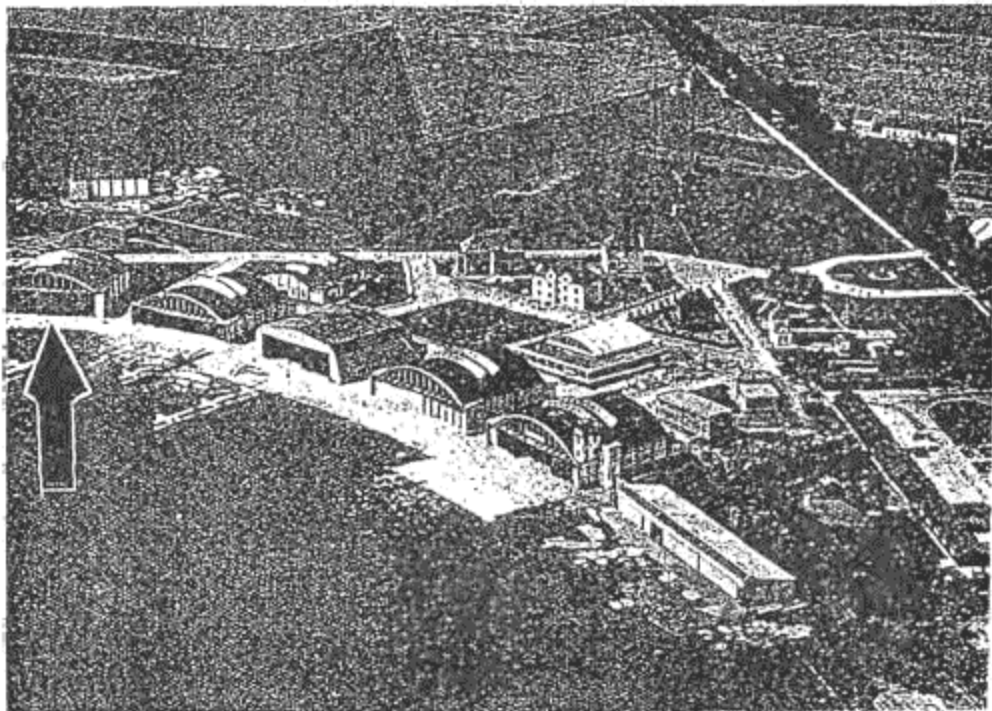
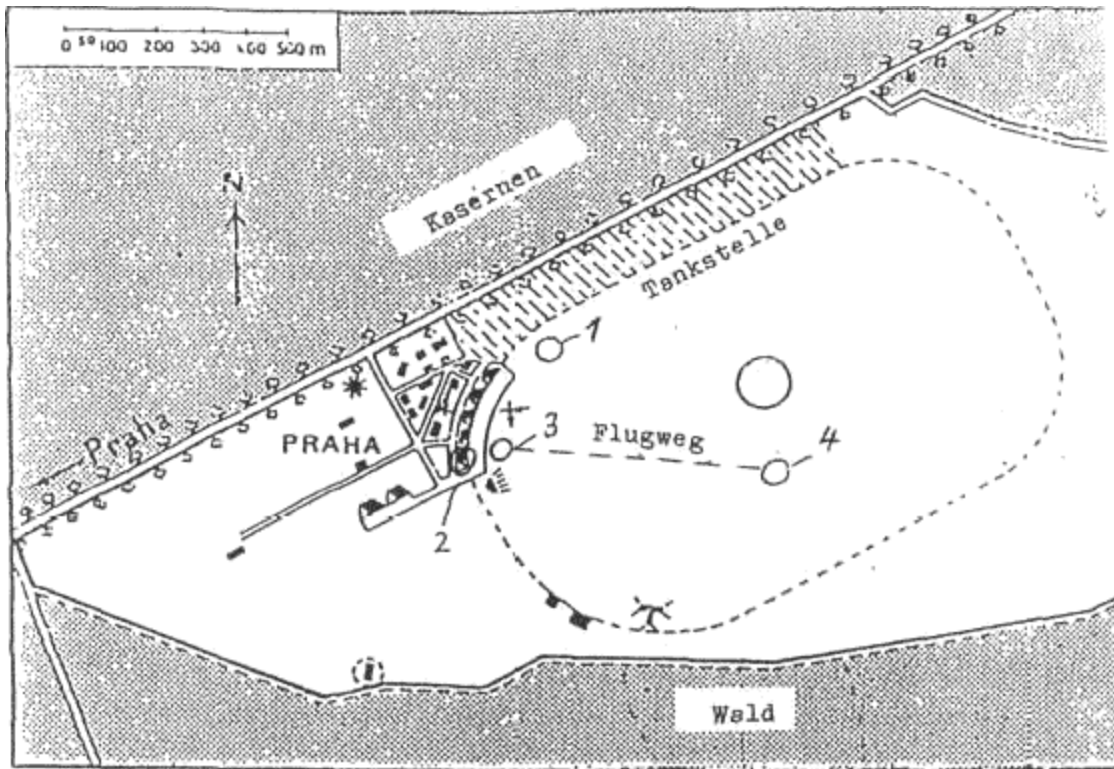

Site of the Schriever and Habermohl Flying Saucer Projects

In the top diagram the hanger which was the site of the research is marked as number 2. The same hanger is indicated in the picture below with an arrow.

**The Habermohl Saucer In Flight**



To the left is the closest shot of the two taken by Joseph Andreas Epp as he drove to the Prag airport in 1944. To the right is a blow up (400 times) of that same saucer. Epp remembers a date of November, 1944 but the foliage on the trees argues for a date earlier in the year.

Rapid horizontal flight was possible with these jet or rocket engines. Probable candidates were the Junkers Jumo 004 jet engines such as were used on the famous German jet fighter, the Messerschmitt 262. A possible substitute would have been the somewhat less powerful BMW 003 engines. The rocket engine would have been the Walter HWK109 which powered the Messerschmitt 163 rocket interceptor (14). If all had been plentiful, the Junkers Jumo 004 probably would have been the first choice. Epp reports Jumo 211/b engines were used (15). Klaas reports the Argus pulse jet (Schmidt-duct), used on the V-1, was also considered (16). All of these types of engines were difficult to obtain at the time because they were needed for high priority fighters and bombers, the V-1 and the rocket interceptor aircraft.

Joseph Andreas Epp reports in his book *Die Realitaet der Flugscheiben* (The Reality of the Flying Discs) that an official test flight occurred in February of 1945. Epp managed to take two still pictures of the saucer in flight which appear in his book and are reproduced here. There is some confusion about the date of these pictures. In the video film "UFOs Secrets of the 3rd Reich", Epp states these pictures were taken in the Fall of 1944. In his book the date is given as the official date of February 14, 1945. In personal correspondence to me of December, 30, 1991, he indicated the date of the pictures as August, 1944. In that correspondence he further revealed that the official flight had been February 14, 1945 but an earlier lift-off had taken place in August of 1944. The pictures show a small disc-like object in the distance at some altitude posed above a landscape. The saucer is at too great a distance and altitude to show any mechanical detail. As Klaus-Peter Rothkugel points out, the foliage on the trees indicates the August date as being the most accurate.

Very high performance flight characteristics are attributed to this design. Georg Klein says it climbed to 12,400 meters (over 37,000 feet) in three minutes (17) and attaining a speed around that of the sound barrier (18). Epp says that it achieved a speed of Mach 1 (about 1200 kilometers per hour or about 750 miles per hour) (19). From his discussion, it appears that Epp is describing the unofficial lift-off in August, 1944 at this point. He goes on to say that on the next night,

the sound barrier was broken in manned flight but that the pilot was frightened by the vibrations encountered at that time (20). On the official test flight, Epp reports a top speed of 2200 kilometers per hour (21). Lusar reports a top speed of 2000kilometers per hour (22). Many other writers cite the same or similar top speed. There is no doubt of two facts. The first is that these are supersonic speeds which are being discussed.

Second, it is a manned flight which is under discussion.

But at least one writer has discounted such high performance(23). It is argued that the large frontal area of one of the possible designs in question makes Mach 2 flight impossible. The argument seems to be that given the possible power plants the atmospheric resistance caused by this frontal area would slow the craft to a point below the figures stated earlier.

Some new information has come to light regarding the propulsion system which supports the original assessment. Although actual construction had not started, wind-tunnel and design studies confirmed the feasibility of building a research aircraft which was designated Project 8-346. This aircraft was not a saucer but a modern looking swept-back wing design. According this post-war Allied intelligence report, the Germans designed the 8-346 to flying the range of 2000 kilometers per hour to Mach 2. (24).Interestingly enough, it was to use two Walther HWK109 rocket engines. This is one of the engine configurations under consideration for the Schriever-Habermohl saucer project.

As an aside, it should be noted that there are those who will resist at any attempt to impugn the official breaking of the sound barrier by Chuck Yeager in 1947 in the Bell X-1 rocket aircraft. They had better brace themselves. This record has also been challenged from another direction. This challenge was reported in February, 2001, by the Associated Press, Berlin. It seems that a certain Hans Guido Mutke claims he pushed his Messerschmitt jet fighter, the Me-262, through the sound barrier in 1945. This occurred during an emergency dive to help another German flyer during air combat. At that time he experienced vibrations and shaking of the aircraft. According to the report,a Hamburg Professor is working on a computer simulation in order to check the validity of this claim.

Returning to the topic at hand, Schriever continued to work Anthe project until April 15, 1945. About this time Prag was threatened by the Soviet Army. The Czech technicians working on this project were reported to have gone amuck, looting the facility as the Russians approached. The saucer prototype(s) at Prag-Gbell were pushed out onto the tarmac and burnt. Habermohl disappeared and presumably ended up in the hands of the Soviets. Schriever, according to his own statements, packed the saucer plans in the trunk of his BMW and with his family drove into Southern Germany. After cessation of hostilities Schriever worked his way north to his parents house in Bremerhaven-Lehe. There Schriever set up an inventor-workshop. On August 4, 1948there was a break in to the workshop in which Schriever's plans and saucer model were stolen (25). Schriever was approached by agents of "foreign powers" concerning his knowledge of German saucers. He declined their offers, preferring rather menial work driving a truck for the U.S. Army (25).

Schriever is reported to have died shortly thereafter in 1953.

There is a report, however, that his death was reported prematurely and that he was identified by a witness who knew him in Bavaria in 1964 or 1965 (26). The publisher of this book, Thomas Mehner, was so kind as to send me a copy of the statement by a Bavarian woman who knew Schriever and made this claim (27). This means that there is a possibility that Schriever did do post-war work on flying saucers.

Interestingly enough, Schriever never claimed that his saucer ever flew at all! If this true, Schriever's saucer was still in the pre-flight stage at the time of the Russian advance and its ultimate destruction on the Prag-Gbell tarmac. This is in direct contradiction to the sources cited above and the photographic evidence. How can this seeming inconsistency be explained?

J. Andeas Epp has always maintained that it was he who originated the type of design used in the Schriever-Habermohl project (28). He states in his book that the imbalance in the ring of wing- vanes which plagued the early Schriever-Habermohl prototypes was a deviation from his original design in which the wing-vanes were lengthened. He states that when they returned to his original design, the saucer was able to take off (29) (30). He referred to the saucer used in the August, 1944 unofficial lift-off, the saucer whose wing-vanes had been altered and then corrected through his intervention, as the "Habermohlischen Version", theHabermohl version (31).

Could the discrepancy referred to above be accounted for if there were actually two lines of saucers built by Schriever and Habermohl? In other words, could the Schriever-Habermohl project have actually been a Schriever project and a Habermohl project,two separate designs within the team? Georg Klein seems to answer this question, stating that "three constructions" which were finished at Prag by the end of 1944. One of these, he says,was a design by Dr. Mieth (32).

The best interpretation of the words of both Epp and Klein would indicate that both Schriever and Habermohl each produced their own design. Schriever made no claim that his design flew. Epp claims the Habermohl design did fly in August, 1944 and again in February 14, 1945. This was the saucer witnessed by both Klein and Epp in flight.

Therefore, the history of the Schriever-Habermohl project in Prag can be summarized in a nutshell as follows: Epp's statement is that it was his design and model which formed the basis for this project. This model was given to General Ernst Udet which was then forwarded to Dr. Walter Dornberger at Peenemuende. Dr. Dornberger tested and recommended the design (33) which was confirmed by Dornberger to Epp after the war (34). A facility was set up in Prag for further development and the Schriever- Habermohl team was assigned to work on it there. At first this project was under the auspices of Hermann Goering and the Luftwaffe (35). Sometime later the Speer Ministry took over the running of this project with chief engineer Georg Klein in charge(36). Finally, the project was usurped by the SS in 1944, along

### A Comparison of the Schriever and Habermohl Designs

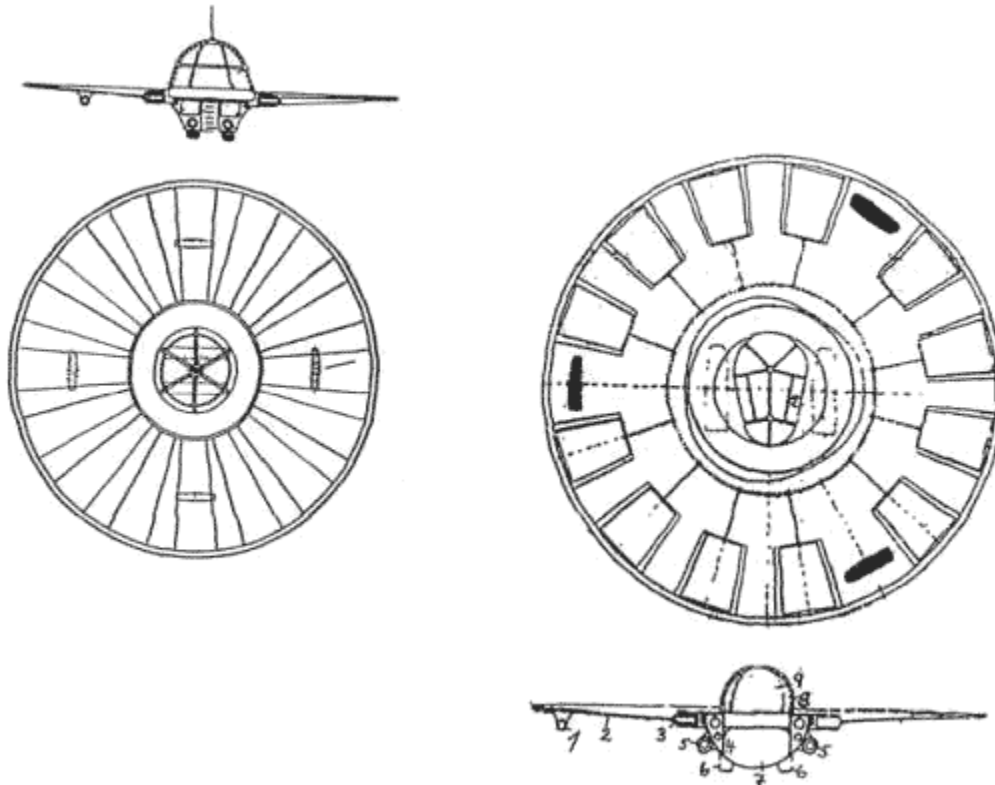

On the left is the Schriever design while on the right is the Habermohl design. Please note the differing dimensions of the vane blades. This difference caused instability in the Schriever design. Drawings adapted from the work of Klaus-Peter Rothkugel.

with other saucer projects, and fell under the purview of Dr. Hans Kammler (37). Schriever altered the length of the wing-vanes from their original design. This alteration caused the instability. Schriever was still trying to work out this problem in his version of the saucer as the Russians overran Prag. Habermohl, according to Epp, went back to his original specifications, with two or three successful flights for his version.

While speaking of flight success, two more pieces of important evidence exists which were supplied by Andreas Epp. One comes in the form of a statement by a German test pilot, Otto Lange, given years after the war to Andreas Epp. In that statement, signed by Lange, Epp is credited with the idea behind the invention of the flying saucer and states that none other than Dr. Walter Dornberger had a hand in its development. He also makes the astonishing claim that he, personally, test flew this flying saucer for 500 kilometers in the course of testing (38) (39).

Otto Lange is a person who is known historically and independently of any connection to Epp. Lange is mentioned in U.S. intelligence documents as a member of the "Rustungsstab"(Armament Staff), for aircraft (40). This is some confusion on this issue since a German researcher, Klaus-Peter Rothkugel, has found evidence for three individuals with this name serving in the German military at this time. Mr. Rothkugel, has suggested that the statement by Lange, discussed above, was, in fact, written by Epp based on known examples of Epp's hand writing. It was signed by another hand, so perhaps





21. Epp, 1994, page 34
22. Luser, 1964, page 220
23. Meier, Hans Justus, 1999, page 10, "Zum Thema "Fliegende Untertassen" Der Habermohlsche Flugkreisel", Fliegerkalender Internationales Jahrbuch der Luft-und Raumfahrt
24. Combined Intelligence Committee Evaluation Reports, Combined Intelligence Objectives Subcommittee, Evaluation Report 149, page 8
25. Der Spiegel, March 30, 1959, "Untertassen Sie fliegen aberdoch" Article about and interview of Rudolf Schriever
26. Zunneck, 1998, page 119
27. This written statement, translated from Bavarian dialect to High German was provided courtesy of publisher Thomas Mehner
28. Epp, 1994, page 30
29. Epp, 1994, page 31
30. Personal letter from J. Andreas Epp dated 12/30/91
31. ibid
32. Klein, Georg, October 16, 1954, page 5, "Die "Fliegenden Teller", Tages-Anzeiger fuer Stadt und Kanton Zuerich
33. Epp, 1994, page 26
34. ibid
35. Epp, 1994, page 27
36. Epp, 1994, page 33
37. 17. ibid
38. Kadmon, 2000, Ahnstern IX, "Andreas Epp", Aorta c/o Petak, 53 Postfach 778, A-1011, Wien, Austria
39. Personal letter from Andreas Epp, dated 12/30/91
40. Kadmon, 2000, Ahnstern IX, "Andreas Epp"
41. Epp, 1994, page 31

## [Section Index](#)

## [Index](#)

## **The Miethe-Belluzzo Project**

This saucer project may have been an outgrowth of flying wing research. It was begun in 1942, and was under the on-site authority of Dr. Richard Miethe, sometimes called Dr. Heinrich Richard Miethe. Not much is known about Dr. Miethe before the war. After the war Dr. Miethe is rumored to have worked on the Anglo-American saucer project at the firm of Avro Aircraft Limited of Canada. Such is stated Klein (1)/ Epp (2), Barton (3), Luser (4), as well as a myriad of other sources. We will return to the Avro projects later.

Working with Dr. Miethe was an Italian engineer, Professor Guiseppe Belluzzo. Belluzzo was the Deputy, Senator and Minister of National Economy under Mussolini. He had written several books on technical matters including Steam Turbines in 1926 and calculations and Installations of Modern Turbine Hydrolics in 1922 (names are English translations of Italian titles). Belluzzo was considered to be an expert in steam turbines. Dr. Belluzzo was not a junior scientist and he was not Dr. Miethe's assistant. He was a senior scientist whose expertise was somehow invaluable on the saucer devices or planned further developments of them.

After the war Belluzzo seems to have led a quiet life in Italy until his death on 5/22/52. Unlike Miethe, however, Belluzzo went on record about German flying discs after the war. He is quoted on the subject in The Mirror, a major Los Angeles newspaper in 1950. This may be the first mention of the subject in the American press. In his obituary in the New York Times his work on the German saucer program is mentioned. (Please refer to copies of these articles).

This team worked in facilities in, Dresden, Breslau and Letow/Prag according to Epp (5). Both this project and the Schriever and Habermohl projects were directed by the same experts and advisors (6). From Epp's discussion, it is clear that Dr. Walter Dornberger first evaluated and recommended his saucer model for further development (7). Miethe is described by Epp in translation as a "known V-weapons designer"(8). The association of both projects to Peenemuende is clear. Both were sanctioned and set up by officials there, probably by Dr. Walter Dornberger himself. Miethe and Belluzzo worked primarily in Dresden and Breslau but for a brief time they may have actually joined forces with Schriever and



Habermohl in Prag, as evidenced by Klein's statement that three saucer models were destroyed on the Prag tarmac (9). One saucer, which Klein he describes as Miethe's was among these. Klein acknowledges that Peenemuende, and its nearby test facility at Stettin, retained and developed the Miethe design as an unmanned vehicle (10)(11).

Epp tells us that the Miethe-Belluzzo project was organized under exactly the same authority as the Schriever-Habermohl project and he further identifies the very same industrial firms which supported Schriever-Habermohl as supporting this project (12). In reality, both should be viewed as one project with different aspects.

## Giuseppe Belluzzo

### Flying Discs 'Old Story,' Says Italian

ROME, March 24 (AP)—An Italian scientist said today that types of flying discs were designed and studied in Germany and Italy as early as 1942.

Adolph Hitler and Benito Mussolini, he added, were interested in the instruments, and the idea was developed concurrently both in Italy and Germany.

Flying discs or saucers have been reported sighted recently in many parts of the world. There has been no scientific confirmation of the existence of such things, nor any universally accepted explanation of what their purpose might be.

The Italian scientist, Giuseppe Belluzzo, noted Italian authority on projectiles and cannons and builder in 1905 of the first steam turbine in Italy, made his declarations in Rome's independent *Giornale d'Italia*.

#### Frequent Reports

"There is nothing supernatural or Martian about flying discs," he said, "but they are simply rational application of recent technique."

Prof. Belluzzo expressed the opinion "some great power is launching discs to study them."

Reports of flying discs in Italian skies have been frequent. The latest report came last night from Northern Turin, where several persons said they saw a saucer speeding across the moonlit sky leaving a fiery trail.

### GIUSEPPE BELLUZZO, SCIENTIST, ECONOMIST

ROME, May 22 (AP)—Giuseppe Belluzzo, Italian scientist and former Cabinet Minister, died here today at the age of 76.

An authority on projectiles and cannons, he reportedly drew up plans for a flying disc which were shown to Adolf Hitler.

Professor Belluzzo, a former Deputy, Senator and Minister of National Economy under Mussolini, said in a newspaper article in March, 1950, "there is nothing supernatural or Martian about flying discs. They are simply rational application of recent technique." He expressed a belief then that "some great power now is launching discs to study them."

In 1905, he built the first steam turbine in Italy.

As Minister of National Economy, Professor Belluzzo told the Italian Chamber in 1927 that Italian industrialists should adopt American industrial organization as their aim. He admitted, however, that Italy could not hope to reach the "rhythm of production and wages existing in America."

He said that Italian manufacturers should reduce the cost of production through technical improvement rather than lowered wages.

In the same year, he noted the tendency of farm youth to migrate toward urban areas and characterized this before the Senate as "pernicious, pathological, anti-racial and uneconomical." Senator Belluzzo urged that youths be judged fit or unfit for city life, and that life on farms be made more attractive by grants for agriculture and frog education.

On the left, a column from The Mirror, dated March 24, 1950. This is one of the earliest English references to German flying discs. On the right is Dr. Belluzzo's obituary, dated May 22, 1952 from the New York Times which again mentions German flying discs.

The designs envisioned by Dr. Miethe and Professor Belluzzo were quite different from those of Schriever and Habermohl. Designs of this project consisted of a disc-shaped craft whose outer periphery did not rotate. Two designs have positively been attributed to Miethe and Belluzzo although three designs exist as part of their legacy.

The first design is made known to us from Georg Klein's article in the October 16, 1954 edition of the Swiss newspaper, Tages-Anzeiger fuer Stadt und Kanton Zuerich, mentioned above. The same design is reproduced in the book by J. Andreas Epp. This saucer was not intended to take-off vertically but at an angle as does a conventional airplane. In this design twelve jet engines are shown to be mounted "outboard" to power the craft. The cockpit was mounted at the rear of the vehicle and a periscope used to monitor directions visually impaired. Notably, a large gyroscope mounted internally at the center of the craft provided stability. This and other Miethe-Belluzzo designs were said to be 42 meters or 138 feet in diameter.

Aeronautical writer Hans Justus Meier has challenged this design on a number of grounds (13). It is certainly possible, if not probable, that the outboard jet-turbine arrangement is incorrect, one might ask, if this was an outboard jet-turbine design, then what purpose did the bloated central body serve? In reality the twelve jets may simply have been jet nozzles of one engine. Certainly the large central body had a function, it must have housed the engine.

But how could the authenticity of this design come under question when Georg Klein is vouching for it in his article? The answer may be that Klein never saw this design himself and he simply is relying on the descriptions of those that did. If one reads the works of Klein carefully, he never claims to have seen this model in flight. As a matter of fact, he never claims to have actually seen this design at all. We will return to the flaws with Klein's description momentarily.

The second Miethe design seems to have originated with a 1975 German magazine article (14). This version shows a cockpit above and below the center of the craft. Four jet engines lying behind the cockpits are shown as the power plants. No real detail is supplied in this article. This design is not ever discussed in the text which deals primarily with the Schriever-Habermohl Project. Some writers have speculated on this particular design, supplying detail (15). For now, however, no named source seems to be able to link this design with the Miethe-Belluzzo Project. Therefore, at least for the time being, we must put this design in suspense and focus on the first and next design in discussing the aforementioned saucer project.

### The Miethe-Belluzzo Disc--Design One



Bild 2: Vertikalschnitt durch Fliegerhülle Miethe  
die schwammige Zeichnung ist wesentlich überhöht

On the left is a reconstruction by Georg Klein, 10/16/54, from the Swiss newspaper Tages-Anzeiger. Note the small "Stabisator" and the outboard jet engines. On the right is Klaus-Peter Rothkugel's more probable reconstruction incorporating fins, skids, and the inner-lying Rene Leduc engine.

### The Miethe-Belluzzo Disc Designs Two And Three

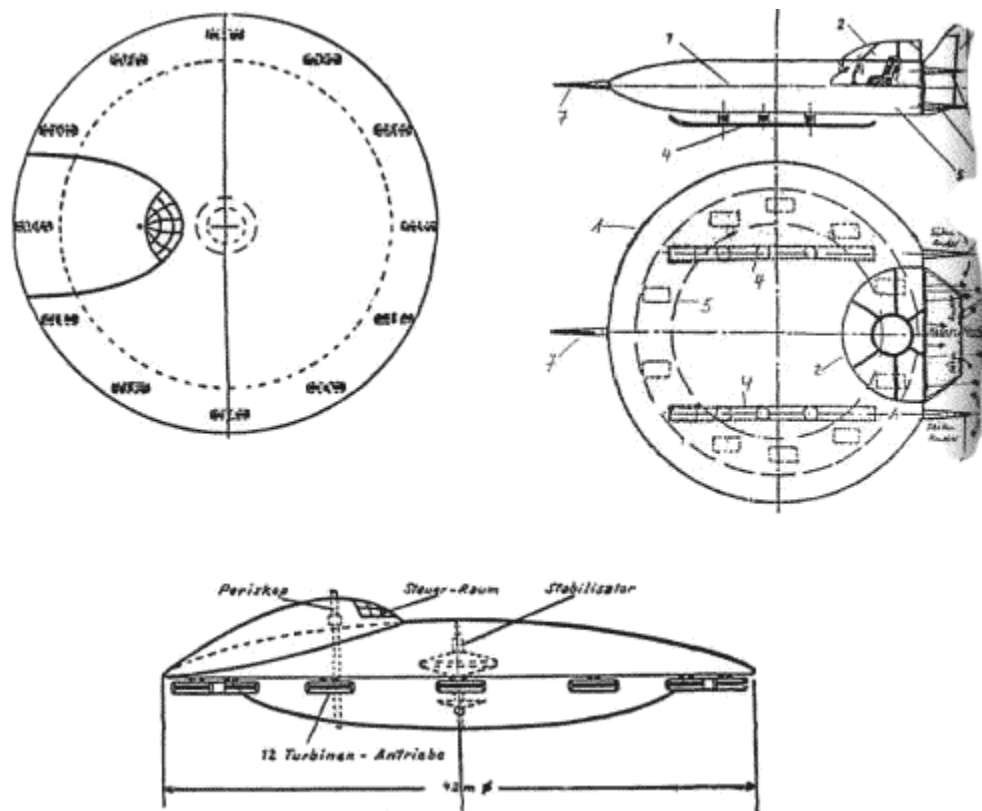
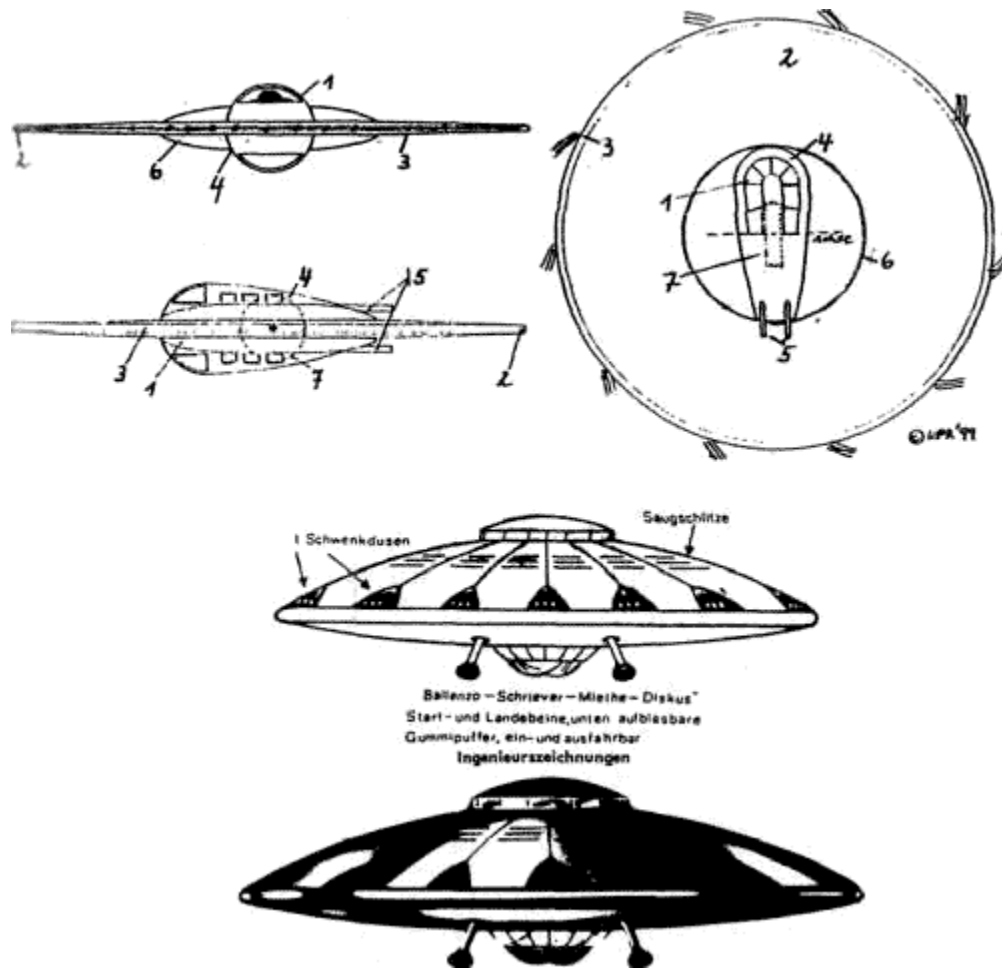

On the top is Miethe-Belluzzo design two. Note rotating disc (2) and stabilizing wheel (7) acting as a gyroscope. (Courtesy of Klaus-Peter Rothkugel) It is the author's opinion that this design was never built. On the bottom is Miethe-Belluzzo design three, capable of vertical take-off.

The third design attributed to the Miethe-Belluzzo Project comes to us from an article by Jan Holberg in an August 20, 1966 article in Das Neue Zeitalter and also from Michael X. Barton-Carl F. Mayer-Hermann Klaas connection (16) (17). This design was capable of vertical take-off. Klaas provides internal detail which has been reproduced here.

At first, this appears to be a push-pull propeller system driven by a single engine. It is not. Neither are the twelve jet nozzles unsupported in any way as depicted. The real answer to this mystery is that this drawing is incomplete. With the completed parts depicted, a radial turbojet engine of special type would appear. Design one differs from design three in that the latter, with its centrally located cabin and symmetrical arrangement of twelve adjustable jet nozzles, is controlled by selectively shutting off various jets through the use of surrounding ring. This allows the saucer to make turns and to take off vertically.

Recently, a German researcher, Klaus-Peter Rothkugel using Vesco as his source (18), has proposed an engine which links the designs one and three, and possibly even design two, while supplying the missing pieces needed to make the engine depicted air-worthy and resolves other problems. This engine was invented by a French engineer, Rene Leduc and probably acquired by the Germans during their occupation of France.

If a flying saucer equipped with this engine were viewed from the outside, no rotating parts would be visible. This is because the engine was totally contained within the metal skin of the saucer. It did rotate but this rotation was within the

saucer itself and not viable from the outside. An air space existed all around the spinning engine, between it and the non-rotating outer skin. This engine was a type of radial-flow jet engine. It was this type of engine which probably powered all of Dr. Miethe's saucer designs. It is also the prime candidate for the post-war design of John Frost, the "Flying Manta."

The Flying Manta actually did fly. Pictures of it during a test flight are unmistakable. They were taken on July 7, 1947 by William A. Rhodes over Phoenix, Arizona. It almost goes without saying that the time frame, July of 1947, as well as the geographical location, the American Southwest, as well as the description of the flying object itself, beg comparisons to the saucer which crashed at Roswell, New Mexico, earlier that same month.

If one looks at what is known of Dr. Miethe's saucer design, the Leduc engine, and the Frost Manta, it must be acknowledged that a connection between these three not only explains apparent inconsistencies in the existing Miethe designs but also links them to the post-war American Southwest, the precise spot where captured German World War Two technology was being tested and evaluated.

### The Rene Leduc Engine

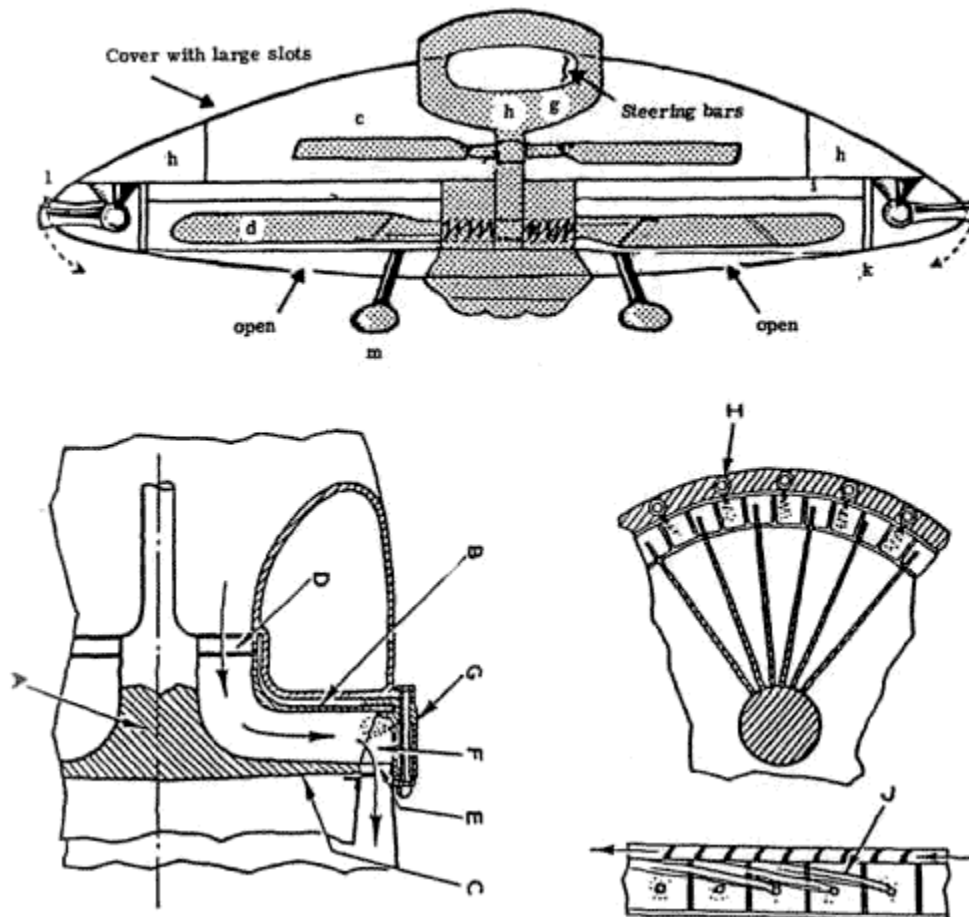

Top: Hermann Klaas' diagram of the workings of the Miethe-Belluzzo Disc. Note: intake screw (c) Carrying wing blade(d) affixed to a piston engine, jets nozzles (e) with no apparent engines. Close but not exactly right. Bottom: Leduc design. A-Rotor B-Front Bulk-head C-Rear Bulk-head D- Intake Vane E-Compressor Vane F-Combustion Chamber G-Bulk-head H-Fuel Injection Jets J-Fixed Flame Ring From I Velivoli Del Mistero I seareti tecnici dei dischi volanti by Renato Vesco

### The Rene Leduc Engine Part Two

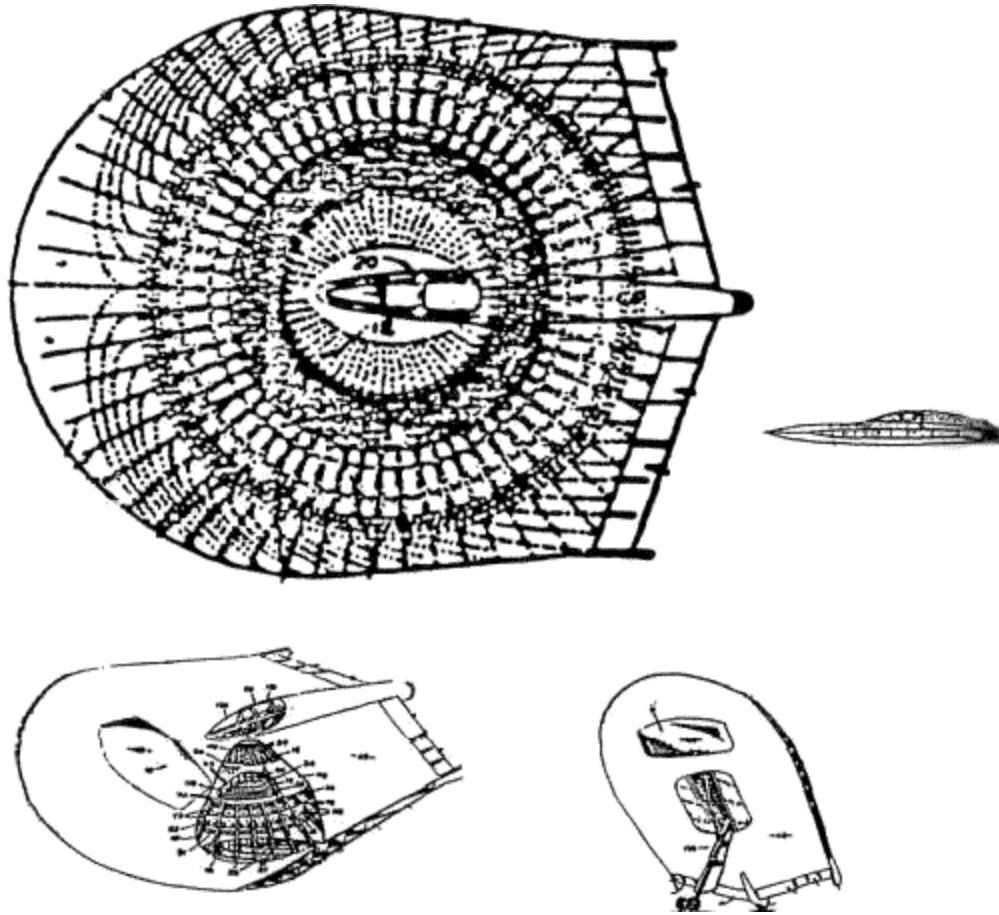

This is the mounting of the Leduc engine as illustrated by the later Avro diagram (Canada-USA). The outer hull is fixed. The inner rotating engine draws in the air from between it and the hull and exhausts through rear or sides as needed for steering. Compare this design to Miethe- Belluzzo designs, especially to the first design.

There is considerable confusion as to where the first test flight of the Miethe-Belluzzo saucer occurred. Epp tells us that models made by this team were flight tested since 1943. Georg Klein, as well as Andreas Epp, state that a test model of this craft took off from Stettin, in northern Germany, near Peenemuende, roughly where the Oder River meets the Baltic, and crashed in Spitsbergen which are the islands to the north of Norway.

A manned test flight in December, 1944 has been mentioned by Norbert Juergen-Rattofer and Ralf Ettl in one of the films on which they worked. The pilot named was Joachim Roehlicke or perhaps Hans-Joachim Roehlicke (19). Klaus-Peter Rothkugel reports that Roehlicke was under the direction of none other than Dr. Hans Kammler himself and was stationed at the Gotha Wagonfabrik company (20). The Gotha Wagonfabrik company is Anthe Jonas Valley in Thuringia. This valley was packed full of high-tech underground facilities which included nuclear research. Roehlicke confided to his daughter after the war, according to Mr. Rothkugel, that he "had seen the earth from above" (21).

Confusion over the test details of the Miethe-Belluzzo saucer start as early as the whole German flying disc controversy its elfin the 1950s. In the English translation of his book, titled Brighter than a Thousand Suns A Personal History Of The Atomic Scientists. a footnote appeared which deviated from the discussion of atomic weaponry. This 1958 description is one of the first in English and may illustrate some of the difficulties in sorting out this information:

" \*The only exception to the lack of interest shown by authority was constituted by the Air Ministry. The Air Force research workers were in a peculiar position. They produced interesting new types of aircraft such as the Delta (triangular) and "flying discs." The first of these "flying saucers," as they were later called -- circular in shape, with a diameter of some 45 yards-- were built by the specialists Schriever, Habermohl and Miethe. They were first airborne on February 14, 1945, over Prague and reached in three minutes a height of nearly eight miles. They had a flying speed of 1250 m.p.h. which was double in subsequent tests. It is believed that after the war Habermohl fell into the hands of the Russians. Miethe developed at a later date similar "flying saucers" at A. V. Roe and Company for the United States." (22).

One big difference between the Miethe-Belluzzo design and the Schriever-Habermohl designs is that the former craft was alleged to have, or be designed to have, a longer flight range. This point is reinforced by the Spitz bergen flight mentioned above. Klein states that the Germans considered long range, remote controlled attack from Germany to New York using this craft.

### Miethe-Belluzzo Saucer In Flight



Top picture is of a September 6, 1952 article in the Italian newspaper "Tempo". This article deals with the work of Dr. Miethe and features a photograph of his saucer allegedly dated April 17, 1944, taken over the Baltic. Bottom is an enlargement of the photograph. It seems to be a Miethe-Belluzzo type 1 but could also be a type 3. Courtesy of Klaus-Peter Rothkugel.

As stated earlier, both projects were under the same authority. Experts and advisors included, according to Epp, among others, head-designer Kalkert of the Gotha Waggonfabrik, head-designer Guenther of Heinkel, engineer Wulf of Arado, engineer Otto Lange of the RLM, and engineer Alexander Lippish of Messerschmitt. Pilots were Holm, Irmler, Kaiser and Lange. The test pilot was Rudolf Schriever.

There does exist two alleged still pictures of the Miethe craft in flight. One is reproduced here. It may be the first design. A picture claiming to be of what is called here the third design can be found in W. Mattern's book, *UFO's Unbekanntes Flugobjekt? Letzte Geheimwaffe Des Dritten Reiches?* (23). Efforts have been made to acquire the picture for this book but the inquiry went unanswered by the book's publisher.

Politically, in 1944, Heinrich Himmler, head of the SS, replaced Albert Speer's appointee, Georg Klein, with Dr. Hans Kammler as overseer of this combined saucer project (24). This is a little confusing, however, since Kammler retained Klein as his employee. Perhaps a more practical way to look at this is that Kammler, Himmler's employee, replaced Speer while Klein did what he always did. The result was that the SS took direct and absolute control over these projects from this point until the end of the war.

Prior to this happening, news of these designs or application itself was made to the German Patent Office. All German wartime patents were carried off as booty by the Allies. This amounted to truckloads of information. Fortunately, Rudolf Lusar, an engineer who worked in the German Patent Office during this time period, wrote a book in the 1950s listing and describing some of the more interesting patents and processes based upon his memory of them (25). They are surprisingly detailed. Included is the Schriever saucer design with detail. Also discussed is the Miethe project.

The significance of these two teams can not be minimized in the history of flying saucers or UFOs. Already in this brief discussion, the evidence, taken as a whole, is overwhelming. Please compare this to any and all extraterrestrial explanations of flying saucers. Here we have Germans who claim to have invented the idea of the flying saucer. We have Germans who claim to have designed flying saucers. We have Germans who claim to have built flying saucers. We have Germans who claim to have flown flying saucers. We have Germans who claim to be witnesses to flying saucers known beforehand to be of German construction. We have German construction details. And finally, we have a man who took pictures of a known German flying saucer in flight. The facts speak for themselves. During the Second World War the Germans built devices we would all call today "flying saucers". No other UFO explanation can even approach this in terms of level of proof.

### **Miethe-Belluzzo Saucer In America?**

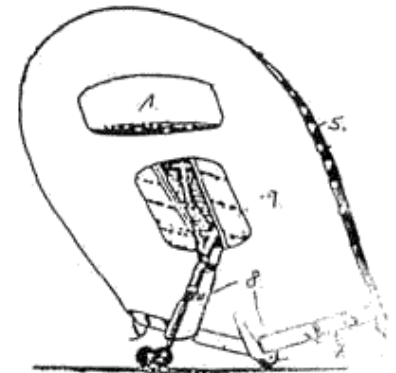
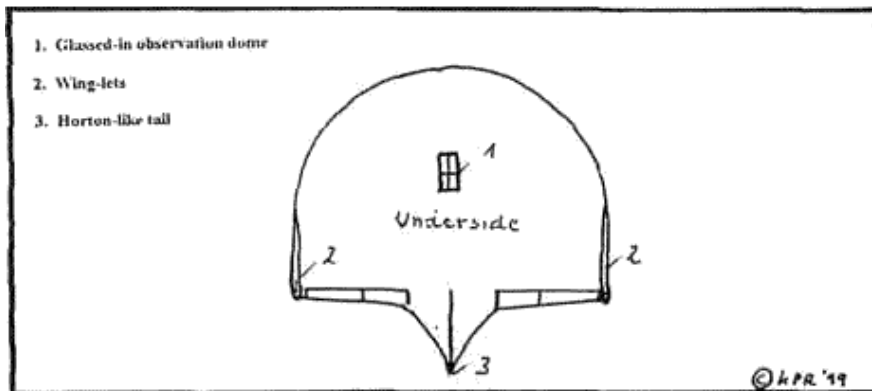
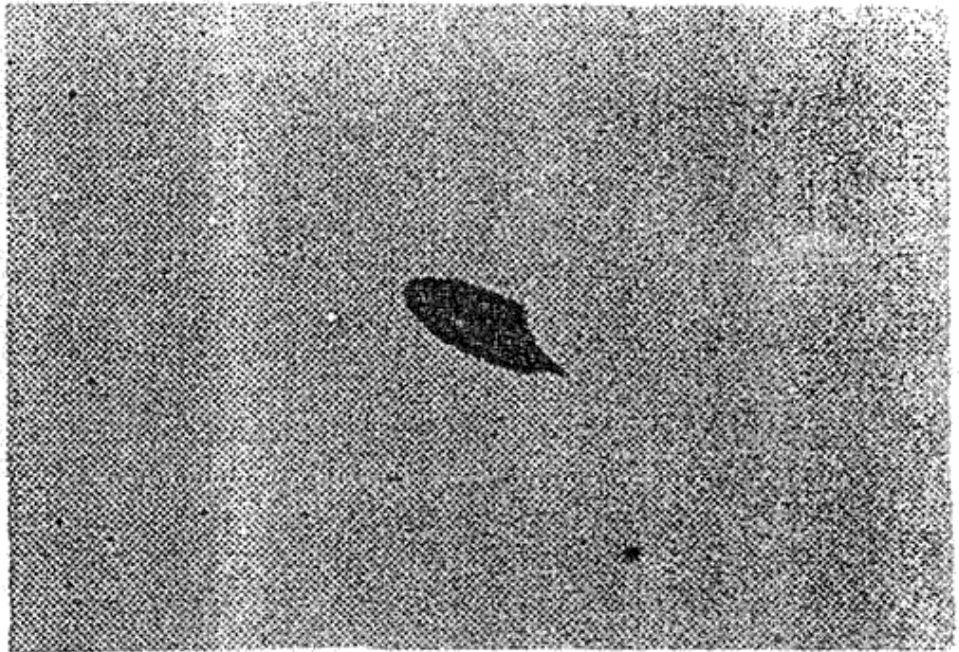

Top: a picture from the July 9, 1947 edition of the Arizona Republic taken by William A. Rhodes as it flew over his home in Phoenix. Lower Left: a drawing of the craft by Klaus-Peter Rothkugel. Lower Right: one view of the Avro Frost-Manta design, predating the Silver Bug Project. Was this a captured Miethe-Belluzzo-Leduc saucer?

### Sources and References

1. Klein, Georg, 10/16/54, page 5, "Die "Fliegenden Teller"", Tages-Anzeiger fuer Stadt und Kanton Zuerich
2. Epp, J. Andreas, 1994, page 34
3. Barton, Michael X., 1968, page 58, The German Saucer Story- Futura Press, 5949 Gregory Avenue, Los Angeles, CA. 90038
4. Lusar, Rudolf, 1964, page 220, Die deutschen Waffen und Geheimwaffen des 2. Weltkrieges und ihre Weiterentwicklung.
5. J.F. Lehmanns Verlang, Munich
6. Epp, J. Andreas, 1994, pages 30-31
7. ibid
8. Epp, J. Andreas, 1994, pages 26-27
9. Epp, J. Andreas, 1994, page 30
10. Klein, Georg, 10/16/54, page 5



11. Zwicky, Viktor, 9/18/54, page 4, "Das Raetsel der FliegendenTeller", Tages-Anzeiger fuer Stadt und Kanton Zuerich
12. Klein, Georg, 10/16/54, page 5
13. Epp, J. Andreas, 1994, pages 30 and 31
14. Meier, Hans Justus, 1995, "Die Miethe-Flugscheibe-einereichlich nebuloese Erfindung", Flieger-Kalender 1995, E.S.Mettler & Sohn, text editing: Hans M. Namislo, Celsius-Str.56, 53125 Bonn, Germany
15. Luftfahrt International, May-June, 1975, "DeutscheFlugkreisel Gab's die?"
16. J. Miranda and P. Mercado, 1998, Flugzeug Profile, page 25-27
17. Holberg, Jan, 8/20/54, "UFOs gibt es nichti Wohl aber: Flugscheiben am laufenden Band!", Das Neue Zeitalter
18. Barton, Michael X., 1968, pages 42, 63, 64
19. Vesco, Renato, 1974, from photos and diagrams beginning on page 392, I Velivoli Del Mistero I segreti tecnici dei dischivolanti. U Mursia editore, Via Tadiuo 29, Milan, Italy
20. Video film, "UFOs Das Dritte Reich Schlaegt Zurueck?", 1988, Tempelhof Gesellschaft, Wien, Available through Dr. Michael Damboeck Verlag, Markt 86, A-3321, Ardaggr, Austria
21. Rothkugel, Klaus-Peter, 2000, page 4, "Baute Peenemuendeueberschallschnelle Flugscheiben?", four page informationsheet concerning supersonic and high altitude saucer construction at Peenemuende, Bad Nauheim, Germany
22. ibid
23. Jungk, Robert, 1958, page 87, Brighter than a Thousand Suns A Personal History Of The Atomic Scientists. Harcourt. Brace and Company, New York, translated by James Cleugh from Heller als tausend Sonnen. 1956, Alfred Scherz Verlag, Bern
24. Mattern, W., date unknown, page 34, UFO's Unbekanntes Fluaobiekt? Letzte Geheimwaffe Des Dritten Reiches?, Samisdat Publishers LTD, 206 Carlton Street, Toronto, Canada M5A 2LI
25. Epp, J. Andreas, 1997. page 33
26. Lusar, Rudolf, 1960, (English version) German Secret Weaponsof the Second World War. Neville Spearman Limited, 112 Whitfield St., London W.I, England

## [Section Index](#)

## [Index](#)

## Foo Fighters

"Foo fighter" is a name given to a small, round flying object which followed Allied bombers over Germany during the latter phases of the air war. There are also some reports of foo fighters in the Pacific theater of the war. Sometimes they would appear singularly but more often in groups, sometimes flying information. By day they appeared to be small metallic globes. By night they glowed with various colors. These object attempted to approach Allied bombers closely which scared the bomber crews who assumed they were hostile and might explode. Upon taking evasive maneuvers they found the foo fighters would keep pace with them in some instances. Besides the name foo fighter this device is sometimes called "Feuerball", its German name or its English translation, fireball. More about names later.

For those readers who have not been exposed to foo fighters before, following is an American flight account found in Intercept UFO by Renato Vesco:

"At 0600 (on December 22) near Hagenau, at 10,000 feet altitude, two very bright lights climbed toward us from the ground. The leveled off and stayed on the tail of our plane. They were huge bright orange lights. They stayed there for two minutes. On my tail all the time. They were under perfect control (by operators of the ground). They turned away from us, and the fire seemed to go out".

Vesco goes on to say:

"The rest of the report was censored. Apparently it went on to mention the plan's radar and its sudden malfunctioning" (1).

Flying saucer books of the 1950s usually mentioned foo fighters and recounted the sightings of Allied servicemen. Later, due to the extraterrestrial hysteria, publications tended to omit descriptions of foo fighters, preferring to begin the tale of flying saucers with Kenneth Arnold in 1947.

In modern times, if they are mentioned at all by mainstream UFO magazines or books, an attempt is sometimes made to confuse the issue of the origin of foo fighters in one of three ways. First, they say or imply that both sides in World War Two thought foo fighters were a weapon belonging to the opposite side. They may cite as a source some German pilot obviously "out of the loop" who claims the Germans did not know their origin. Second, they attempt to advance the idea that foo fighters are still unknown and a mystery or possibly a naturally occurring phenomenon. Third, they advance an extraterrestrial origin.

It is difficult to imagine a vast bad faith plot, extending over years, which attempts to discredit or confuse the issue of foo fighters. Perhaps the authors of these UFO magazines and books are truly without a clue and simply perpetuating old and bad information as a convenient explanation. In any event, it is now clear they utterly failed to do their homework on foo fighters before writing about them.

#### The First Reports Of German Foo Fighters

**SUPREME HEADQUARTERS, Dec. 13 (Reuter)—The Germans have produced a "secret" weapon in keeping with the Christmas season.**

The new device, apparently an air defense weapon, resembles the huge glass balls that adorn Christmas trees.

There was no information available as to what holds them up like stars in the sky, what is in them, or what their purpose is supposed to be.

### ***Floating Mystery Ball Is New Nazi Air Weapon***

**SUPREME HEADQUARTERS, Allied Expeditionary Force, Dec. 13—A new German weapon has made its appearance on the western air front, it was disclosed today.**

Airmen of the American Air Force report that they are encountering silver colored spheres in the air over German territory. The spheres are encountered either singly or in clusters. Sometimes they are semi-transparent.

Top: A Reuters report from December 13, 1944 Bottom: The New York Times, December 14, 1944

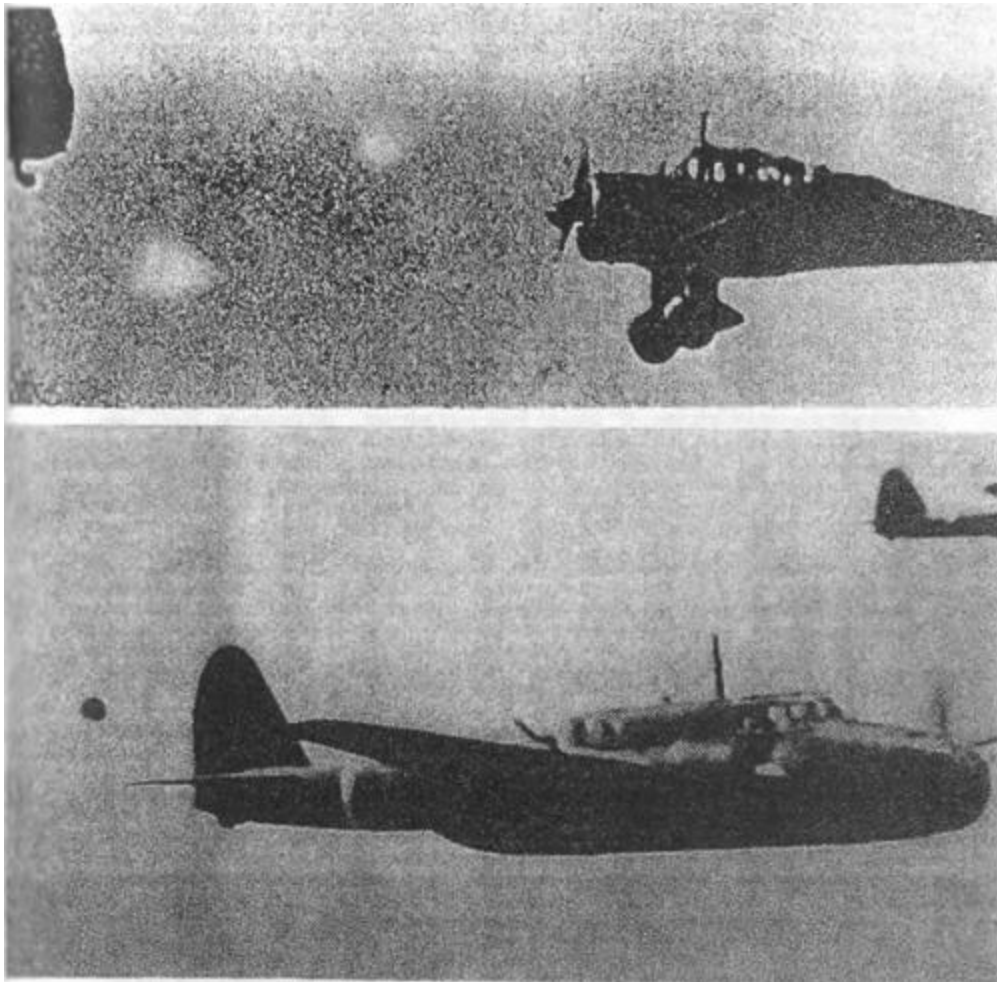

### Foo Fighters In Flight

Top: At night or in dim light foo fighters appeared luminescent. Bottom: In strong light foo fighters appeared as silvery balls. This picture was taken over the Pacific in 1943. There are many stories speaking of small, round flying balls sent to Japan by the Germans via submarine.

The U.S. military, too, has always denied knowledge of foofighters. Numerous Freedom Of Information Act (FOIA) request shave been filed, for instance, by this writer as well as other researchers asking for information on foo fighters. A "no record" response always followed. All U.S. governmental agencies queried claimed that they had never heard of foo fighters. This happened in spite of the fact that all known alternate names for foo fighters were submitted as well as a detailed description of the device itself. This was the situation until the late 1990s.

Vesco is by far the best source concerning the foo fighter which he calls "Feuerball". He describes it as a radio controlled missile, built at an aeronautical establishment at Wiener Neustadt (Austria) with assistance of the Flugfunk Forschungsanstalt (Radio-Flight Research Installation) of Oberpfaffenhoffen. The project was under the control of an SS technical division. It was armored, circular in shape, resembling the shell of a tortoise. The device was powered by special flat, circular a turbojet engine. After being guided to the proximity of the target from the ground, an automatic infra-red tracking device took over control. The circular spinning turbojet exhaust created a visual effect of a bright, fiery ball in the nighttime sky. Within the craft itself a klystron tube pulsed at the frequency of Allied radar making it almost invisible to those remote eyes. A thin sheet of aluminum encircled the device immediately under the layer of protective armor but was electrically insulated from the armor. Once a bullet pierced the armor and the thin aluminum sheet, a circuit was formed which had the effect of triggering the Feuerball to climb out of danger at full speed (2).

Once within range, special chemical additives were added to the fuel mixture which caused the air in the vicinity of the device to become ionized. This meant that electricity could be conducted directly through the air itself (3). Any ignition-based engine coming into range of the ionized region would become useless, misfiring, stalling and eventually crashing.

Vesco goes on to say that with the advance of the Soviets into Austria the production facilities for the Feuerball were moved to a number of underground plants in the Black Forest run by the Zeppelin Works (4).

Recently an Austrian researcher, Kadmon, who specializes in uncovering the esoteric, sent to me a copy of a letter describing details of the foo fighter from the German perspective. This letter is reproduced here for those who read German language. It is a letter from physicist Friedrich Lachner to Professor, Dr. Alois Fritsch. The letter tells Dr. Fritsch that in an aircraft plant which was a branch of Messerschmitt at Wiener-Neustadt, Austria, a test model of a flying craft was built with a diameter of five meters which presumably made a test flight to Vienna. "His Martha", his wife, saw the outline of an exactly elliptical flying object in the twilight which appeared to her to be operating by some other means of flight that was normally the case because of its sudden directional changes. Her reaction was that it was an enemy flying object and it scared her.

After the bomber attack on the plant, a doctor, "Oskar L." saw a model of this frightful thing in the plant also and had no idea of what it was. The astronomer Waehnl was, during the war, employed calculating construction costs at this aircraft facility where she had earlier in life learned something of aircraft technology from her father. She confirmed it also. Lachner briefly spoke with an engineer named Kuehnelt who worked as in flight technology for the German Army. He explained to Lachner that he saw such a device with a diameter of fifteen meters. Lachner says that he had known for some years about a machine with a thirty meter diameter. He also says that he had gotten to know a flight engineer named Klein when he was active near the flight testing of the supreme chief General Udet. Lachner claims that "Klein had something to do with these things".

One or more unmanned and remote controlled of this sort of spinning-top-like flying objects are mentioned by Lachner in connection with the massive Allied bomber raids on the ball-bearing plant at Wuerzburg. Finally, Lachner goes on to say that a Professor Richter built these devices for Peron in Argentina. A long distance test-flight was actually flown to the United States. There the device was intercepted and an American pilot was shot down. The remainder of the letter concerns nuclear developments in Austria and the USA before and after the Second World War and misunderstandings by Lusar in his book.

This letter was written in 1975. Details concerning Klein and the larger flying objects were in print by that time. There are important confirmations within this letter. These are revelations concerning Lachner's wife as an eyewitness to the object in twilight flight, the medical witness who saw the object within the plant at Wiener-Neustadt, and the confirmation of the astronomer, Waehnl. Unfortunately, Kadmon advises that Dr. Waehnl is now deceased. The important point is that these are real people with real names. Most of whom were alive at the time of this letter. Further, some of these people were scientists with a reputation at stake yet they did not disavow the substance of this letter in any way.

In the closing months of the last millennium witnessed a breakthrough regarding foo fighters. The break came by accident and from the government of the United States. Remember, Freedom Of Information Act requests regarding foo fighters had been filed with many branches of the U.S. military and intelligence services as well as with their repository, the National Archives. Even though all known alternative names were included, as well as a detailed description of the device in question was provided, a "no record" response was uniformly generated by all facets of government.

### **Austrian Atomic Scientist Professor Friedrich Lachner's Letter**

Sehr geehrter Herr Dr. Fritsch!

Besten Dank für Ihren Brief mit den Flugkreisel-Ablichtungen. Im Kriege hörte ich davon in Fachkreisen. In der Wiener Neustädter Flugzeugfabrik die ein Filialbetrieb der Messerschmitt-Werke war, wurde ein Versuchsmodell von 5 m Durchmesser hergestellt, das vermutlich auch Versuchsflüge bis nach Wien gemacht hat. Meine Martha sah einmal so ein wegen der Perspektive ziemlich genau elliptisch aussehendes Ding, wobei ihr die ganz anders gear- tete Art des Fluges auffiel, nämlich auch ganz plötzliche Richtungsänderungen. Sie konnte gut sehen, da es nur wenig dämmerig war und noch sehr hell. Am Flugkörper war in der Mitte noch etwas dran. Sie hielt das Ding als etwas feindliches und lief ängstlich heim und hat dann nicht mehr sehr genau hin- gesehen. Gleich nach dem schweren Bombenangriff auf die Flugzeugfabrik, den ich vom Berg bei Fischau aus sah, war mein Vetter der Medizinalrat OSKAR L. drinnen um Verletzten zu helfen. Dabei sah er ein solches arg be- schädigtes Modell und wusste aber damals nicht was es war. Die Astronomin WAHNL war im Kriege auch als Konstruktionsberechnerin in dieser Flug- zeugfabrik, da sie ja auch schon früher von ihrem Vater flugzeugtechnische Kenntnisse hatte. Auch sie hat es bestätigt. Kürzlich sprach ich mit einem Ing. (Kühnelt) der als Flugtechniker bei der Wehrmacht war und der mir von einem solchen Gerät mit 15 m Durchmesser, das er sah, erzählte. Schon vor vielen Jahren habe ich von einem mit 30 m Durchmesser erfahren. Einen Flugingenieur KLEIN habe ich, als ich bei der Flugerprobung (oberster Chef General UDET) tätig war, kennengelernt, der mit solchen Dingen zu tun hatte. Einmal ist er wenige Meter vor mir abgestürzt. Obwohl das Flugzeug zerbrach ist ihm nicht viel geschehen. Ich führte ihn damals gleich zum Flugchef.

Ein (oder mehrere) unbemannter ferngesteuerter Kreisel-Flugzeugkörper dieser Art, wurde in Würzburg (F.u.S. — Werke für Kugellager) dem da- mals dicht beieinander fliegenden Bomberpulk zum Verhängnis (400 Bomber an einem Tag erlegt). Ich hörte dass Prof. RICHTER für den PERON in Argentinien den Bau solcher Geräte organisiert und konstruiert hat, wobei es weite Versuchsflüge bis USA gab. Ein USA-Flieger der sich feindlich entgegen- stellte, wurde abgeschossen. Als RICHTER noch in Wien war, haben wir Vor- lesungen bei Prof. SMEKAL besucht. SMEKAL hat Kernreaktionen an die Ta- fel geschrieben für Atombomben und Atommeller, auch lange vor dem 2. Krieg über die Tritium-Lithium-Atombombe, die erst jetzt die USA realisiert, wie ich erfahren habe. Wien war weit voraus wenigstens in der Theorie. Da man damals den Betrag der kritischen Masse nicht genau wusste, fand ich durch einen Konstruktionstrick einen Ausweg, der aber bald nicht mehr nötig war. LUSAR hat meine Angaben missverstanden, da ich mit meinen Angaben, ja keineswegs behauptete Atombombenerfinder zu sein. Die Grundidee hatte ja schon HASENOHRL 1904, wie mir Prof. MACHE mitteilte, bei dem ich Assi- stent war. Eine Abschrift dieser Angaben von mir (Physiker-Ing. F. LACH- NER) können Sie mit Zitierung der Fachzeitschrift mitteilen. Was das LACH- NER-Gerät zur Verbesserung des Auflösungsvermögens betrifft, dessen Prio- rität mir von Prof. R. entwendet wurde, da er mich als Urheber des Grund- gedankens, samt Konstruktion und Theorie nicht zitiert hat, so kann ich Ihnen mitteilen, dass bereits einige Hochschulprofessoren erklärt haben für meine Priorität einzutreten. Auch Prof. THURING sollte davon erfahren. Er war im Kriege Leiter der Wiener Sternwarte, wo jetzt R. ist.

Mit freundlichem Grusse usw.

FRIEDRICH LACHNER

Zaprimijeno, decembar 1975.

Adresa autora: Prof. Phys.-Ing. Friedrich Lachner

A — 1140 Wien, Linzerstr. 415/1/6, Österreich.

Professor Lachner describes a sighting of a foo fighter by none other than his wife, Martha. Lachner mentions that he heard that Professor Richter built these devices for Juan Peron in Argentina. This, incidently, is the same Professor Richter involved in an ill-fated attempt to produce fusion generators for Peron.

A German researcher, Friedrich Georg, recognized a valuable entry in a microfilm roll, titled a 1944 U.S. Strategic Air Forces In Europe summary titled An Evaluation Of German Capabilities In 1945, which, somehow, had eluded the censors (5). In that summary report German devices called by American Intelligence "Phoo Bombs" are discussed. Sources for this summary were reports of pilots and testimony of prisoners of war. Phoo bombs were described as "radio-controlled, jet-propelled, still-nosed, short-range, high performance ramming weapons for use against bombing formations". Speed was estimated at 525 miles per hour.

Further demands were made using FOIA as to the raw data used to compile the summary evaluation. Of course, denials followed, but finally, after an Appeal, the government indicated that more information did exist concerning Phoo Bombs. Most of this was a repeat or re-statement of the summary document. One document was hand-written and may have served as the basic text of the report.

It seems the U.S. Air Force was never aware of a threat to aircraft engines coming from over ionization of the air around these devices. Likewise, the claim by Vesco that they possessed klystron tubes which pulsed at the same frequency of Allied radar and so jammed radar on board was not recognized. Vesco cites the aircraft radio research institute at Oberpfaffenhofen (F.F.O.) as having invented such devices (6).

The Combined Intelligence Objectives Sub-Committee report on this facility. Report 156, states that work there involved several types of klystron tubes and that one of this facilities principal functions was inventing technology to jam Allied radar, unfortunately all the secret material held at this facility was burned in the face of the advancing Allies. Individual scientists later produces some copies of documents which represent what the Allied intelligence strike teams took away. Exactly how complete this sample was we will never know (7).

Other very exotic research did go on at the F.F.O. installation which might be mentioned. They not only did work on klystron tubes but on magnetrons also. They did work on generation of millimeter range radio wave through the use of crystal vibrations. They also experimented with silicon and germanium "crystals" (8). These two substances figure prominently in the making of what we call today semiconductors which form the basis of the transistor. Invention of the transistor is credited to William Shockley, for which he won the Nobel Prize, about two years after the Second World War.

This bit of research explodes an argument made by the late Col. Philip j. Corso in his book The Day After Roswell that transistors were, at least in part, based upon alien technology(9). The only questions which remain are: exactly how far the Germans progressed in their work on semiconductors and should the scientists at the F.F.O. have been given credit for this discovery, the transistor, instead of Shockley? This example also illustrates exactly how far the military will go, or at least individuals in the military, to perpetuate the notion of high-technology derived from aliens. It also illustrates the willingness of large establishment publishing firms to assist in the propagation of these ideas.

**The U.S. Government Knew Truth All Along**

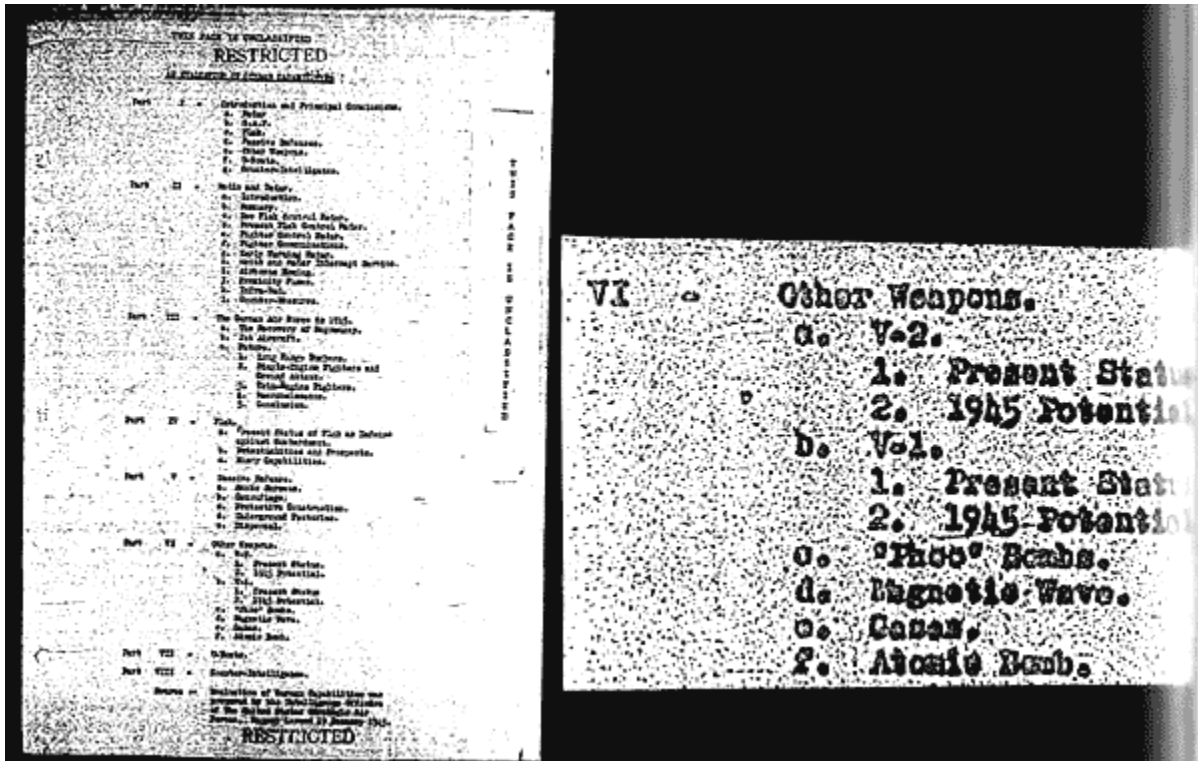

U.S. government's own documents prove they knew of the German origin of foo fighters. This table of contents of a "Intelligence Digest" document, with a February, 1945 date, addresses German military capacities. It lists "Phoo Bombs" as a weapon in the German arsenal (see VI- OtherWeapons) Taken from microfilm negative image.

**A UFO Rosetta Stone**

~~CONFIDENTIAL~~

CLASSIFIED  
UNCLASSIFIED

TO BE RETURNED TO THE ARCHIVES OF THE AIR HISTORICAL OFFICE	519285 1945
--	----------------

HEADQUARTERS

UNITED STATES STRATEGIC AIR FORCES IN EUROPE  
OFFICE OF THE DIRECTOR OF INTELLIGENCE

AN EVALUATION OF GERMAN CAPABILITIES  
IN 1945

FORM NO. 107 DATE 10-1-46 COPIES 1 COPY TO 1
---

~~CONFIDENTIAL~~

CONFIDENTIAL

519-53

This document, fascinating in its own right, serves as a translation. "Foo fighters are "Phoo Bombs" in the government's parlance. No more "no record" name-games from the government.

A UFO Rosetta Stone A UFO Rosetta Stone

~~TOP SECRET~~

PART SIX - OTHER WEAPONS

1. In the following paragraphs are listed the actual or potential weapons which the Germans may use against UNSTAF operations in 1945. For the most part they include the so-called V weapons. No consideration is given to those for which there is lacking evidence of possible use for some time to come. Both V-1 and V-2 are considered in this analysis because, even though they are, in effect, long-range artillery, they do possess the ability to affect our operations by hitting airfields, and supplies enroute and in concentrations.

2. V-2:

a. Present status. The V-2, or rocket projectile, with a warhead of approximately one ton, and a current range of 225 miles, is being fired at London at the rate of 180/250 per month, and against Continental ports at the rate of approximately 300 per month.

Against London its accuracy is currently rated at 3.2/1,000 per square mile at the main point of impact. Against Continental ports it is estimated at the least 6.1/1,000 per square mile at the main point of impact. The best record was 75 in a twenty-four hour period within a four square mile area of the Antwerp Docks.

b. 1945 Potential: The German plan calls for an increase in monthly production from 600 to 1200. It is known, however, that any increase would be at the expense of the aircraft industry in radio equipment and certain essential components. An increase in accuracy would depend upon increased firings and increased use of already proved radio equipment, without which the majority of firings are conducted today. It is thought unlikely that range will be materially increased. Accuracy begins to fall off somewhere between 165 and 190 miles, and becomes increasingly inaccurate to the maximum of 225 miles. Whether or not V-2 becomes an increased menace in 1945 must depend upon the position of the aircraft industry and its requirements. Its potential lies in stallization of the expanding aircraft program.

Larger rockets (68 feet in length as against 45 feet) are known to exist, and may appear in small quantities during the year. They would have a considerably larger warhead.

3. V-1:

a. Present Status: The so-called Flying Bomb is being fired from launching ramps against Continental targets, ports and supply concentrations, at the rate of 600 per month, and against England by airborne launchings, at the rate of 250 per month. Accuracy against Continental targets is now between 11.0/1,000 per square mile at main point of impact, and against England at 3.3/1,000 per square mile at main point of impact.

b. 1945 Potential: Here again, the German plan calls for an expansion in production, but, as in the case of V-2, this expansion must be at the expense of other vital industries. Authoritative estimates state that airborne launchings against England may reach 450 per month, and that a very substantial increase of launchings on the Continent will take place. On the other hand, the number of He-111s available for airborne launchings is distinctly limited, and the demands of other industries are such that the expanded production may not be carried out as planned.

4. "PROQ" BOMBS: Occasionally reports by pilots and the testimony of prisoners of war and escapees describe this weapon as a radio-controlled, jet-propelled, still-nosed, short-range, high performance ramming weapon, for use against bombing formations. Its speed is estimated at 525 mph

~~TOP SECRET~~

T  
H  
I  
S  
  
P  
A  
G  
E  
  
I  
S  
  
U  
N  
C  
L  
A  
S  
S  
I  
F  
I  
E  
D



~~CONFIDENTIAL~~

and it is estimated to have an endurance of 25 minutes. These bombs are launched from local airfields, and are radio-controlled, either from the ground, or possibly by aircraft. The few incidents reported by pilots indicate no success. They have passed over formations, and performed various antics in the vicinity of formations. It is believed that in order to be effective some 100/200 would have to be launched against a formation, and it is also believed that they will not be produced in sufficient quantities to prove a real menace in 1945.

5. MAGNETIC KAVE: The best information available is from very secret and reliable sources, and forces the conclusion that this weapon exists as a possibility. It is designed to cause failure of various electrical apparatus in aircraft. Technically it does not appear to be a possible serious threat in 1945. At most it would be effective at a few locations for preventing ground strafing. Evidence to date indicates that it could have little effect against high level attack, since the apparatus would be too cumbersome to permit its use in aircraft.

6. GASES APPLICABLE TO AIRCRAFT: Two types of gases applicable to aircraft are known. One is designed to cause pre-ignition, blowing the heads off cylinders; and the other is designed to break down the viscosity of lubricating oils. Under laboratory conditions, free from operational considerations, these gases are a distinct possibility. It is doubtful, however, that with proper fighter escorts a sufficient concentration of either of these gases could be thrown against our formations to have any serious effect. Similarly, it is doubted whether sufficient anti-aircraft guns are available to produce an effective concentration, and it is probably that any possible concentration would be no more effective than a similar amount of well-directed flak.

7. ATOMIC BOMB: Close check of every report, and close surveillance of the area in which tests are alleged to have taken place lead to the conclusion that such bombs are not a likelihood in 1945.

T  
H  
I  
S  
  
P  
A  
G  
E  
  
I  
S  
  
U  
N  
C  
L  
A  
S  
S  
I  
F  
I  
E  
D



In this same document is a description of a gas-weapon first described by Vesco and designed to down enemy aircraft (10). Actually, there are two such gas weapons. The first gas is designed to cause engine destruction through pre-ignition as described by Vesco. The second gas is designed to cause engine seizure through the breakdown of the viscosity of the engine's lubricating oil. This is another vindication of Vesco. Therefore, when Vesco states that this very weapon was successfully used against Allied aircraft in a second-generation saucer, the Kugelblitz, perhaps he should be taken seriously(11).

Finally, this document describes something the Americans call the "Magnetic Wave" but which the Germans always described as "Motorstoppmittel", meaning literally, "means to stop motors". Motorstoppmittel and other German death rays were also the subject of repeated FOIA requests which were all denied. It was only with the code-word "Magnetic Wave" that the dam of information was finally broken concerning this device and other German ray-weapons. Not only did the Germans use ionization of the atmosphere to halt ignition based engines but they also experimented with x-ray weapons and an even more exotic method, possibly involving use of the laser (12).

Vesco places construction of the foo fighter at the Austrian site of Wiener-Neustadt (13). Indeed, the testimony supplied by Kadmon does indicate an Austrian home for the foo fighter. The most likely site for foo fighter development was the Rax Works. The Rax Works were an outgrowth of the combinations and growth of several firms, the Wiener-Neustaedter Flugzeugwerke GmbH, the Flugzeugbau der Hitenberger Patronenfabrik, the Flughafenbetriebsgesellschaft Wiener-Neustadt and the Wiener Neustaedter Lokomotiv-Fabrik which was acquired by Henschel after the unification of Austria and Germany (14).

All the sources cited place foo fighter production in Austria. It is often repeated that this was a purely SS project, built at Wiener-Neustadt, with the help of the F.F.O. It is possible that these craft had an independent origin, outside the scope and sphere of Peenemuende. At about this same time, early 1943, Professor Alexander Lippisch broke away from Messerschmitt to head the Vienna based Luftfahrtforschungsanstalt-Wien (LFW). This was a first-class facility and Professor Lippisch is a figure central to the understanding of German flying discs. Vesco links the foo fighter, his "Feuerball" with a further-developed manned saucer, the "Kugelblitz". It is possible that both these craft had an independent origin, that is outside the purview of officials at Peenemuende under the direction of Dr. Lippisch at the LFW. In this case their link to Peenemuende would have become stronger as the war progressed and on a higher order, that of the SS through Dr. Hans Kammler and the Kammler Group based near Prag. It is also possible that the research and controlling authority of the German disc program moved from Peenemuende to Wiener-Neustadt as researcher Klaus-Peter Rothkugel suggests.

Questions arise with the acknowledgment of "Phoo Bombs" by the government. The first is what is the agenda of those seeking to deny this fact both in and out of government? Are these just extraterrestrial "true believers" gone amuck? There is no doubt that the government has known the truth about foo fighters and German saucers in general for almost sixty years, yet they have never been willing to publicly acknowledge these facts. Why is this? What issues of national security could possibly be compromised with such a disclosure over a half-century later?

### **Captured Foo Fighters In The USA?**

# Airborne Objects Watched

TWO SILVERY balls flashed across the Salt River valley north of Phoenix at 3:31 o'clock yesterday afternoon—and were watched for 25 to 30 seconds by a score or more persons in upper floors of the Heard Building.

All the witnesses were agreed on the main points:

FIRST ONE "ball" was sighted, then the other. At first glance the objects were thought to be bal-

FIRST ONE "ball" was sighted, then the other. At first glance the objects were thought to be balloons—until the extremely high speed of west-east flight was noticed.

Both objects appeared to be identical in size, were estimated to be at 5,000 feet altitude, and to be "about twice as large as an airplane."

THE OBJECTS were flying on two levels until near the end of the valley passage when the lower "ball" climbed sharply to the level of the upper.

The estimated distance traversed while they were under observation, and the endurance of the flight, indicated a speed well over 1,000 miles an hour.

SEVERAL OBSERVERS noted that at the time of the flight the air was so still that smoke columns rose straight to high altitudes, and flags hung limp against their staffs. There was no noticeable air movement for an hour, when a rain storm began to approach the city from the northeast.

The Arizona Republic during the afternoon received a number of calls from persons who said they saw the "silvery balls". None reported the "flying saucers" which have been reported from various parts of the country.

From "The Arizona Republic", July 8, 1947 83

Is this denial of foo fighters just of government inspiration? The sad truth is that the private "information" or disinformation sector is also guilty in of a cover-up. Why do they contribute to the denial of the German origin of this technology? What major New York publisher has ever published on German flying discs as opposed to the libraries of books pushing the extraterrestrial UFO hypothesis—a hypothesis totally lacking in proof? Let me pose the specific question: would Simon and Schuster ever publish a book on the German origins of flying saucers as they did for Col. Corso and his extraterrestrial hypothesis? If not why?

Another question arises from the confirmation of foo fighters by the government. This question concerns the veracity of Renato Vesco who originally placed the topic before us in his Italian edition as early as 1968. The question is this: If Vesco is right about foo fighters, what about the other claims he made about German saucers? Specifically, these are claims made about the further development of the foo fighter technology resulting in a manned saucer project he called "Kugelblitz" (ball-lightning). As well as claiming the Kugelblitz actually flew, Vesco gave us some tantalizing details of the development of German saucer technology by the Anglo-Americans after the war. In view of Vesco's track record, we can not simply dismiss these claims as has been done in the past. Vesco's assertions should be borne in mind as further facts become evident.

Finally, there is some small evidence that the Americans did acquire working examples of these foo fighters. If the Americans had captured complete examples of the foo fighter one would expect they would be taken to existing testing

facilities in the Southwestern United States and tested as were other examples of captured German technology. This appears to be the case. The Arizona Republic reports a sighting dated July 8, 1947 involving two flying silvery balls which can only be foo fighters.

## Foo Fighters

### Sources and References

1. Vesco, Renato, 1976, page 82, Intercept UFO. Pinnacle Books, Inc., 275 Madison Ave, New York, NY. 10016, recently reissued as Man-Made UFOs 1944-1994 by Adventures Unlimited Press
2. Vesco, Renato, 1976, pages 85-86
3. ibid
4. Vesco, Renato, 1976, page 87
5. United States Air Force, 1944, "An Evaluation Of German Capabilities In 1945", Maxwell Air Force Base, Alabama, USA, this and other information related to Phoo Bombs can be found on microfilm rolls A-1007-1652, A-5729-2040
6. Vesco, Renato, 1976, pages 85-87
7. Combined Intelligence Objectives Sub-Committee Report Number 156, "Report On Flugfunk Forschungsinstitut Oberpfaffenhofen F.F.O. Establishments"
8. ibid
9. Corso, Phillip J., Col., 1997, page 161, The Day After Roswell. Pocket Books, a division of Simon & Schuster Inc., 1230 Avenue of the Americas, New York, NY. 10020
10. Vesco, Renato, 1976, pages 136-138
11. Vesco, Renato, 1976, pages 145 and 156
12. German Research Project, 1999, "German Death Rays Part Two: The German And American Governmental Evidence", P.O. Box 7, Gorman, CA. 93243-0007 USA
13. Vesco, Renato, 1976, page 86
14. Rothkugel, Klaus-Peter, not yet published, page 31, Das Geheimnis der deutschen Flugscheiben

### [Section Index](#)

### [Index](#)

## The Peenemuende Saucer Project

A report comes to us from Russian immigrant Paul Stonehill concerning the experience of a Russian POW in Northern Germany. The report was first published some time ago in UFO Magazine, volume 10, number 2 in 1995, but this witness describes a story so different from other German saucer reports that it is worth emphasis at this point. The witness is unnamed but the source of the original report is known to Paul Stonehill and he vouches for its authenticity. The unnamed witness is called mister "X".

Mister X was taken prisoner by the Germans in the Ukraine in 1941, early in the German offensive. From there he was housed in a concentration camp where he contracted typhus. X improved and even managed to escape but was recaptured and taken to Auschwitz concentration camp. There, he worked as a medical orderly before a typhus relapse made this work impossible. X was scheduled for a one-way trip to the crematorium but was saved from this fate by a woman German medical doctor who cured him of the typhus. Not only did she do this but, for some reason not made clear in the article, she supplied him with false identity papers stating that X was a mechanical engineer.

In August of 1943 X was moved to KZ (concentration camp) A4 at Trassenhedel in the vicinity of Peenemuende to work on project Hochdruckpumpe's removal from that area. Hochdruckpumpe, or high pressure pump in English, was a long distance cannon with fired in sequential states as the projectile moved by each charge and along an very long barrel. From here X was reassigned to work at Peenemuende itself.

In September of 1943, X and some other prisoners were engaged in demolition of a reinforced cement wall. At lunch time the other prisoners were driven away from this site but for some reason, possibly a dislocated foot, X was left behind.

After the others had gone, four workers appeared from a hangar and rolled out a strange looking craft onto the concrete landing strip nearby. It was round, had a teardrop-shaped cockpit in the center and was rolled out on small inflatable wheels, like an "upside down wash basin". After a signal was given, this silvery metal craft began making a hissing sound and took off, hovering at an altitude of about five meters directly over the landing strip. As it hovered, the device rocked back and forth. Then the edges began to blur. Suddenly the flying craft's edges seem to blur as it jumped up sharply and gained altitude in a snakelike trajectory. X concludes that because rocking was still exhibited, the craft was advancing erratically.

A gust of wind blew in from the Baltic. The flying craft was turned upside down and began to lose altitude. Mr. X was enveloped by hot air and the smell of ethyl alcohol as he heard the craft grinding into the earth. Without thinking, X ran for the craft in an effort to assist the downed pilot. The pilot's body was hanging out of the broken cockpit and the craft was engulfed in blue flames of fire. X glimpsed the still hissing jet engine before everything was swallowed in flames.

What can be gleaned from this account? Mr. X certainly saw a German flying disc. But the "smell of ethyl alcohol" and the "blue flames of fire" set this engine apart from any so far described. German jet engines ran on jet fuel, a light oil something similar to kerosene. The Walter rocket engines ran on very exotic hypergolic fuels which burst into flames automatically once they made contact with each other. Ethyl alcohol is the alcohol of fermentation as, for instance, potatoes are fermented and distilled into vodka. Ethyl alcohol is not the best substance for aircraft fuel since it is low calories by weight and volume in comparison with the other fuels mentioned. The advantage of alcohol for the shortage plagued Germans was that it was available. Ethyl alcohol and liquid oxygen were exactly the fuels which powered the V-2 rocket developed at nearby Peenemuende.

Given this report, we have a reason to consider Peenemuende as a German site which produced flying discs. But before proceeding with our inquiry as before we must take a step back from our strictly detailed survey of German flying saucers in order to get better perspective of this overall body of information.

To this point any reader somewhat familiar with German flying discs might find the level of detail and proof enlightening but might feel that the basic story is known and has already been told. These readers will be pleasantly surprised by this chapter of our story. Not only is new evidence presented here but a new interpretation of existing evidence sheds a whole new light upon the study of German flying discs.

This new evidence and this new way of looking at things are primarily the result of the input of German aeronautical investigator Klaus-Peter Rothkugel. Within the last year or so he has proposed to me and to another investigator, Heiner Gehring, ideas which were previously overlooked. Mr. Rothkugel has investigated and documented his ideas to both of us and has convinced us of their merit. In turn, both Mr. Gehring and myself have spent some time and effort in advancing this research ourselves and sharing the results. These researchers have published their findings in Germany and have allowed me to make use of these ideas here.

The careful reader will note that mention has already been made of Mr. Rothkugel and his contributions. In this section some of the ideas which he first put forth will be examined as will his emphasis on the overall organization and understanding of the material.

It was Vesco who first gave us an explanation of foo fighters.

Vesco relied upon his own understanding of the subject which was gained during the war and documented them with facts gleaned from his research into British intelligence files. His explanation has been largely vindicated both by reports of sightings within Austria and through United States military documents obtained independently through the Freedom Of Information Act. Why then should not the other explanations given us by Vesco be worthy of further inquiry? While discussing German saucer development, Vesco described German research designed to overcome the drag limitations imposed upon aircraft by boundary layer effects.

Boundary layer effects refer to the flow of air across the wing of an aircraft in flight. The air forms sheets of air moving across the wing, the slowest moving sheet being closest to the wing. At high speeds these slower moving layers collide with oncoming air molecules of the atmosphere causing areas of turbulence which translate into atmospheric drag as a practical matter. Elimination of the boundary layer would mean that the aircraft could fly faster or expend less energy to fly at any given speed (1)(2).

Swept wings, a German innovation, represent an aircraft designer's response toward lessening the effects of drag on high speed aircraft wings. It was found that air passing over the wings at an angle retarded boundary layer formation. Therefore, turbulence was less apt to form. The swept back-wings of the Me-163 rocket interceptor may have been the

result of this research. An advanced model of the Me-262 jet fighter was to incorporate fully swept-back wings. But German aircraft designers of those times wanted to go further. They wanted to eliminate the boundary layer completely.

They proposed to do this with suction wings (3). The literature on German efforts toward elimination of the boundary layer using suction wings is voluminous, as Vesco has pointed out. Beginning in the early 1940s German designers cut slots into experimental aircraft and auxiliary engines were employed to suck in the boundary layer through the wing itself and redirect this air into the fuselage and out the rear of the aircraft.(4). This proved to be more complicated than first anticipated. It was found that the area of turbulence, eddy currents caused by the boundary layer, moved across the wing from front to back as air speed increased. A slot at one position on the wing might work at one speed but not another. This meant that many, many slots covering the expanse of the wing would be needed to totally defeat this boundary layer problem. This proved impractical for a number of reasons.

One reason this was so was that multiple engines had to be used. The first engine had to provide power for flight as in any airplane. The second engine, mounted in the fuselage, was necessary to draw in air through the slotted wings and exhaust it towards the rear. Interestingly enough, it was found that the boundary layer could be eliminated by "sucking it in" or by "blowing it off" using a strong flow of air to disrupt it (5).

Full scale suction wing aircraft were built for purposes of testing this concept. These were the Junkers "Absaugflugzeug"(suction aircraft) AF-1 and the Fieseler "Absaugestorch" (suction-stork) AF-2.

Concurrent with these experiments, work was being done into the feasibility of circular wings. This work also began in the 1930s with the basic ideas being credited to Professor Ludwig Prandtl. Early scientific papers on circular winged aircraft were written beginning in 1936 by Wilhelm Kinner (6) and in 1938 by M. Hansen(7). Both of these scientists worked at the Aerodynamic Research Facility at Goettingen. By 1941 Dr. Alexander Lippisch was also engaged in experimentation on circular wings at the Messerschmitt firm. His design, designated J1253, was tested at the wind-tunnel at Goettingen (8). Dr. Lippisch was visited by Dr Giuseppe Belluzzo while at Messerschmitt in Augsburg and Lippisch worked together with Dr. F. Ringlib on a "Drehfluegel" or "rotating wing" which was tested at Peenemuende (9). As with suction wings, a body of scientific literature from those times documents this early circular-wing experimentation.

The genius of the German designers was to combine the ideas of suction and circular wings into a single aircraft. Housing complete aircraft within its wing would eliminate the fuselage and so eliminate an unnecessary, drag-causing structure.

Prandtl and Lippisch were not comparably to Schriever and Habermohl. Prandtl and Lippisch are not even comparable to Dr. Richard Miethe. Prandtl and Lippisch were senior scientists who were well established in their worlds, either of whom would have been capable of heading a major project. In fact they did. In fact neither the Schriever-Habermohl or what we have called the Miethe-Bellonzo projects were major projects. This is another significance of what is being discussed here because what is being discussed here is a completely different organization and understanding of German flying discs than has been presented heretofore.

Remember that controlling authority for both the Schriever-Habermohl and the Miethe-Bellonzo projects came from officials in Peenemuende? J. Andreas Epp makes the point in his book that he originated the idea of the Schriever-Habermohl-type of flying disc and actually made a model of this flying craft. Setting aside for the moment the subject or originality, Epp sent his model to General Ernst Udet of the Luftwaffe whom he had met as a child. General Udet must have been impressed with this idea because he sent the plans and model to Peenemuende for evaluation. Peenemuende authorized the Schriever-Habermohl team to further develop the idea and as you might recall, Epp chided Schriever for straying from his original blade dimensions while crediting Habermohl for keeping them. The point is that Peenemuende set up Schriever and Habermohl to construct and further develop this design as they set up Dr. Miethe to set up further develop the Leduc engine based design. The Germans even refer to the Schriever-Habermohl design as a "Flugkreisel" or flying top in English and the Miethe design as a "Flugdiskus". Our vernacular, "flying saucer" originally corresponded to the German folk-word "Flugschiebe" or flying disc. If the Flugkreisel, Flugdiskus and Flugschiebe are all different machines and we know who built the first two then who built the third, the Flugscheibe? The answer is that Peenemuende built the Flugscheibe. Officials at Peenemuende saved the best for themselves while controlling the other two.

Let's look at some evidence. The May, 1980 issue of Neue Presse featured an article about the German fluidics engineer Heinrich Fleissner (10). Fleissner was an engineer, designer and advisor to what he calls a "Flugscheibe" project based at Peenemuende during the war. It is interesting to note that Fleissner's area of expertise, fluidics, is exactly the specialty involved in investigating problems with boundary layer flow. Fleissner reports that the saucer with which he was involved would have been capable of speeds up to 3,000 kilometers per hour within the earth's atmosphere and up to 10,000 kilometers outside the earth's atmosphere. He states that the brains of the developmental people were found in Peenemuende under the tightest of secrecy (11). We will return to this article again, at a later point, but what is of most

interest to us here are three facts. First, that Fleissner worked at Peenemuende on a flying saucer project. Second, that a hint of this design has survived to this day. Third, the surviving design can be linked to photographic evidence of a German saucer, circa World War Two.

Almost ten years after the war, on March 28, 1955, Heinrich Fleissner filed a patent application with the United States Patent Office for a flying saucer (Patent Number 2,939,648). Fleissner's saucer was unlike Schriever's, Habermohl's, or Mieth's. The engine employed by Fleissner rotated around the cabin on the outside of the saucer disc itself. It was set in motion by starter rockets as with Schriever and Habermohl. The difference is that this engine was really a form of ram-jet engine. It featured slots running around the periphery of the saucer into which air was scooped. The slots continued obliquely right through the saucer disc so that jet thrust was aimed slightly downward and backward from the direction of rotation. Within the slots, fuel injectors and a timed ignition insured a proper power curve which was in accordance with the speed and direction of the saucer much like an automobile's fuel injection is timed to match the firing of the spark plugs. Steering was accomplished by directing the airflow using internal channels containing a rudder and flaps which ran alongside of the central cabin. The cabin itself was held stationary or turned in the desired direction of flight using a system of electromagnets and servo-motors coupled with a gyroscope (12).

It is interesting to note that while the patent was filed on March 28, 1955, it was not granted until June 7, 1960, over five years later! What could possibly have been the reason for the delay? The only possible reason concerns the American Silver Bug Project which was being developed at the same time. This was a project which was tasked with further development of the Mieth design or an outgrowth of it and simply referred to as a "radial jet engine". But we now know this Mieth project was not the equal of the Peenemuende project in terms of speed. The Americans must have realized this sometime after the filing of Fleissner's patent. There can be little doubt that the reason for the delay of the Fleissner patent was the evaluation and possibly the pirating of his design by the Americans. At about the same moment that Fleissner's patent was granted, it was announced that the joint Canadian-American saucer project, Silver Bug and its derivatives, had been abandoned by those governments. The only possible reason for this abandoning was that they had found something better and the better design, by far, was Fleissner's.

### The Post-War Saucer Patent Of Heinrich Fleissner

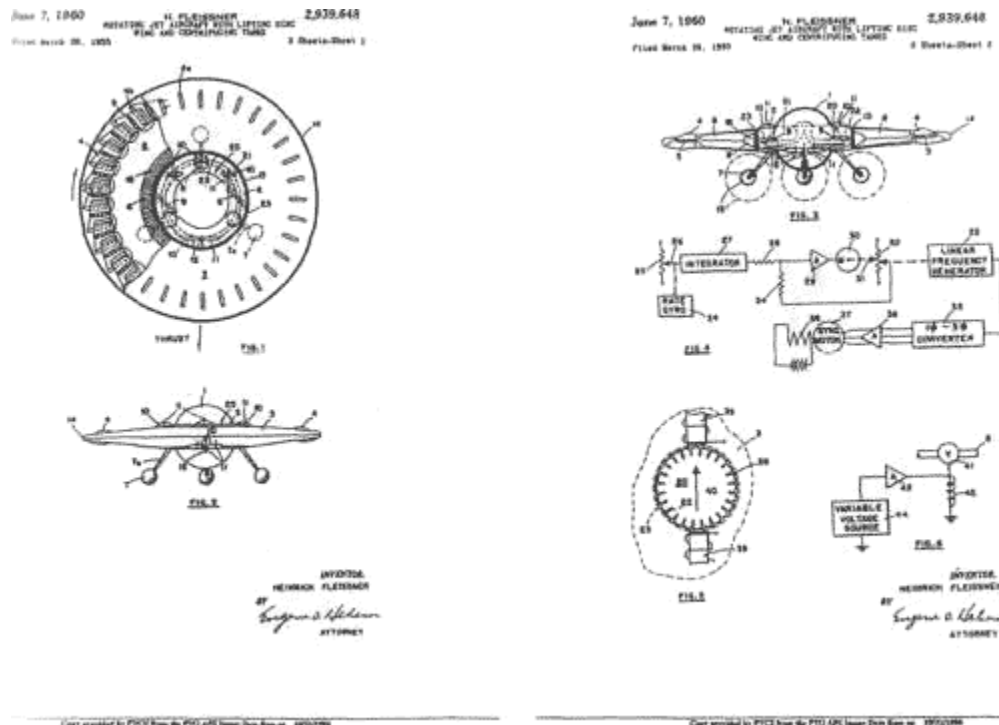

Fleissner was a technical advisor on the Peenemuende saucer project. An eye witness, known by Fleissner, told him this: "Shortly before the Capitulation, on April 24, 1945, a squadron of four flying discs took off-manned with two pilots whose names are unknown-under heavy artillery barrage from the German and Russian sides from the Berlin- Lichterfelde Airport to a still-today unknown destination." (Neue Press, 5/2/80, page 3)

Fleissner's design was likened to a ram-jet earlier. It could function in this way but it was also much more than a ram-jet. Fleissner states in his patent that the saucer could be powered by any number of fuels: "liquid, dust, powder, gas or



solid"(11). It could have used, for example, used the recently re- discovered fuel first made by Dr. Mario Zippermayr consisting of finely powdered coal dust in a suspension of liquid air (13) or "Schwammkohle" ("foam coal") and liquid air (14). Different fuel mixtures and types could be accommodated simply by varying or adjusting the type of injectors and ignition used. We know that the Germans used hypergloic fuels during the war, that meaning fuels which ignited simply by coming in contact with one another."C-Stoff" and "T-Stoff" were German designations for the hypergloic fuels used in the Messerschmitt Me-163 rocket interceptor, for instance. These fuels could also have been used in this engine as well. Feissner further elaborated in his 1980 article stating that liquid hydrogen and liquid oxygen were suitable for this design (11). Liquid hydrogen and liquid oxygen are rocket fuels of the highest order. This means Feissner's saucer could function as a rocket with the proper fuel.

Shall we assess the implications? In its simplest form, Feissner's saucer could have operated as a ram-jet on jet fuel. At its highest level, Feissner's saucer could have operated outside the atmosphere on liquid hydrogen and oxygen. Or it could have done both. Feissner's saucer could have taken off as a ram-jet, gained speed and altitude but at some point, reached a limit of diminishing returns. At this point, the saucer would have been able to slowly bleed liquid oxygen into the ram-jets for further performance enhancement. Further, it could slowly have replaced jet fuel with liquid hydrogen. This would be accompanied by a closing of the air intake apparatus. At this point there is no reason this saucer can not become a space ship, that is, able to operate beyond the fringes of the earth's atmosphere. Is this performance enough to impress the U.S. Air Force and the civilian population of the late 1940s and early 1950's? The answer is certainly in the affirmative.

### Detailed Picture Of A German Saucer

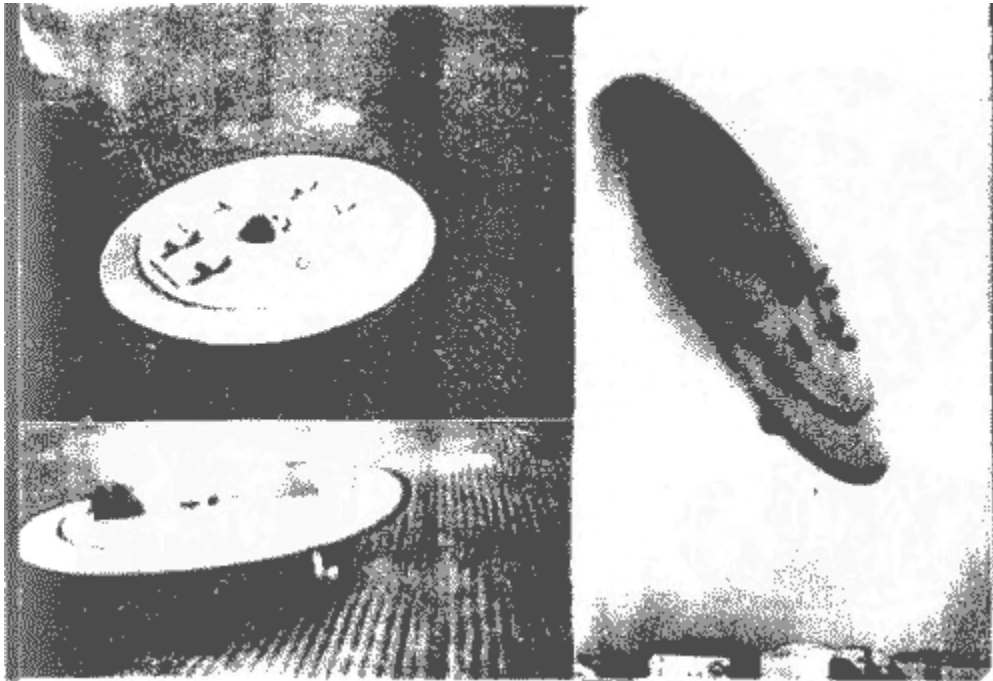

This is a blow-up of the picture attached to J. AndreasEpp's "Still Alive" letter from Prag, March, 1944. Note air intake ring and crest for steering on the roof of the cabin. Diameter is about six meters. Is this the saucer described in the Aftonbladet article? Possible location is Stettin near Peenemuende.

### Thinking Outside The Box Hybrid Liquid-Solid Propellant Rocket

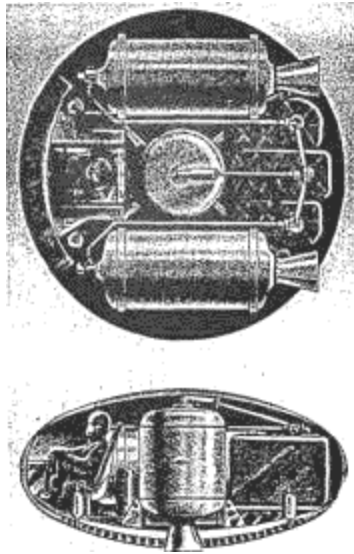

EIN BÜNDEL von Hybrid-Triebwerken läßt sich leicht zu Startstufe einer Großrakete zusammenschließen. Ein einziger Tank (1) genügt zur Aufnahme des Oxidators, der durch Düsen (2) in die mit festem Brennstoff (3) ausgekleideten Kammer eingespritzt wird. In den kleinen Kugelflächen (4) befindet sich ein Zündmittel, das die Verbrennung startet.

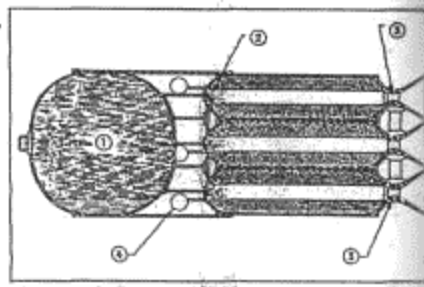

FLÜGGERÄTE nach den Versuchs- ges der Luftes An- druck sollten auf dem Höhenflug eines zeh- nstündigen Hoch- flugzeugs (Vorschau) und durch zwei Hoch- geschwindigkeit er- reichen. Die Schäl- den könnten ähnlich wie Aufhänger für die US-Air-Force, aber auch bei Expediti- onen (auch auf dem Mond und dem Mars) eingesetzt werden.



Top Right: 1. Liquid Oxidizer 2. Injection Jets for Oxidizer 3. Combustion Chamber Constrictions 4. Ignition Mechanism Solid fuel shown running along sides of combustion chamber (dark color). "Schaumkohle" (porous compressed coal) are suitable as fuel as would a mixture of Aluminum powder and polyurethane combined with liquid nitrogen tetroxide. Thrust controlled by amount of oxidizer injected. Hypergolic mixtures would require no ignition system. Alternately, oxidizers could be solid and fuel liquid. "Nichts ist unmöglich" Nothing is impossible

There are design elements in the Fleissner saucer which link it to the work of Prandtl and Lippisch. It should be noted that the slot air intakes mounted near the edge of the saucer would have sucked in the boundary layer before it got any real chance to form. Below, the jets would have blown off the boundary layer at a similar point. Further, because the entire wing, the saucer, is spinning, any further development of a boundary layer would have been moved at an angle and so almost nullified as happens with severely swept-back wings of a conventional high-speed jet aircraft. Therefore, at supersonic speeds, this saucer might not have even generated a sonic boom.

There is some proof that the Fleissner-type of saucer was actually built and flown at Peenemuende or a nearby test facility at Stettin. Fleissner's patent is likened to wartime reality by a photograph. Actually, it is three photographs. These photographs have appeared in a fragmentary, vintage Dutch article on German saucers and they are attached to a wartime letter from Prag sent to this writer by J. Andreas Epp and later published in Ahnstern (15). No specific mention of the photograph is made in the letter and so it could be that the late Mr. Epp included it as a general example rather than a specific reference. Epp never claimed the saucers in these photographs as his design. Epp himself claimed to have the only photographs of that device. There is reason to suspect, however, that this design does bear a relationship to the Fleissner design.

The pictures show a small saucer with some telling features. One point of correspondence with the Fleissner patent is that the air intake is located near the periphery of the saucer wing. This is seen as seen in the ring just inside the saucer's edge. The other is that the directional control is clearly viable in the rudder mounted on the top of the cockpit or central cabin. In the picture the control is external and not as sophisticated as the Fleissner patent but the idea behind both are the same. In the pictured saucer, turns would be made by turning the cabin as a whole, thus, turning the rudder just as the prehistoric flying reptile, the Pterodactyl, turned its flight direction using a rudder located on top of its head.

Further confirmation of a Peenemuende saucer project comes from a Stockholm evening newspaper, Aftonbladet, dated October 10, 1952. It reports that a flying saucer, a "space ship", was developed by the Germans during World War Two at Peenemuende by Dr. Wernher von Braun and his rocket team. A test-model of this craft lifted off in April of 1944. It was six meters in diameter. The ultimate craft to be built, was a space ship of 42 meters in diameter, capable of flying an astonishing three hundred kilometers in altitude! Not stated in the article but interesting to note is that this 300 kilometers represents a higher altitude than the first American earth orbiting satellite.

**Hitler's A-7 Weapon?**



slightly over a yard. This saucer roughly corresponds in size to the description given in the Aftonbladet article. The picture on the right, minus the fuel drums and poised above some buildings, clearly shows that this saucer actually flew.

A whole technical history and organizational hierarchy can be pieced together from this picture, the Fleissner patent, and the Aftonbladet article. The Fleissner design minimizes the effects of boundary layer resistance reflecting the outcome of work starting with Ludwig Prandtl. It is a circular aircraft and a linear descendant of the circular aircraft designed by Dr. Prandtl and Dr. Alexander Lippisch. Fleissner states that he worked at Peenemuende. Peenemuende functioned as the head of all German saucer research. A fact of life at Peenemuende was that all German scientists deferred to Dr. Wernher von Braun who was an expert, the only expert, at everything. Dr. von Braun did have an organizational supervisor, Dr. Walter Dornberger, later to work for Bell Aircraft in the USA. Above Dr. Dornberger was Dr. Hans Kammler, the SS chief of all jet aircraft and vengeance weaponry. All these named men and organizations were part of the German saucer program, their public denials notwithstanding.

One more loose end is tied up relating to the Fleissner design. This is the relationship of Dr. Giuseppe Belluzzo to the German saucer projects as a whole. Remember, Dr. Belluzzo was a senior scientist and engineer who specialized in materials and steam turbines. The Fleissner saucer design is normally thought of as a sort of ram-jet. But this ram-jet spun due to thrust imparted to it by its exhaust. This exhaust-supplied motion scooped in and compressed the incoming air before ignition. Low speed flight would have been impossible without this feature just as it is with any ram-jet. So another way to look at this engine is that it was a turbine-ram-jet no matter how incongruous this may sound at first. It should also be noted that in the rocket mode, when the saucer is burning only liquid oxygen and liquid hydrogen, the products of this combustion are only heat and water. Another way to say heat and water is steam. To repeat, Dr. Giuseppe Belluzzo was a steam-turbine expert. As mentioned earlier, Mr. Rothkugel reports that Dr. Belluzzo visited and, presumably consulted with, Dr. Alexander Lippisch at Augsburg. Dr. Belluzzo's involvement with the German saucer projects should not be assumed to be confined to the Miethe project.

Let's review the Peenemuende Project to this point. It is a wide ranging project with at least two spin-offs, the Schriever-Habermohl project and the Miethe project. The Schriever-Habermohl project(s) employ a whirling set of vane-blades and one or more rocket or jet engines in a kind of "spinning top" manner. It may have been capable of supersonic flight. The Miethe project differs in that it employs an internal spinning turbo-jet first invented by Rene Leduc. Depending on the saucer configuration, its thrust can be vented in any direction for steering purposes. It also may have been capable of supersonic flight.

This design was given further study and was probably developed after the war in the form of the John Frost "Manta". A design such as this may have been responsible for the sightings by Kenneth Arnold near Mt. Rainier in the State of Washington in June of 1947. It was probably responsible for the pictures taken by William Rhodes as seen and described in the July 9, 1947 edition of the newspaper, The Arizona Republic. This same design, described as a "Flying Shoe" may have figured in the Roswell crash. Ideas from this design may have been further developed by A.V. Roe, Limited company in Canada.

Besides retaining overall control of these two saucer projects, the officials at Peenemuende retained and developed their own saucer project. Using similarities between surviving pictures from the time and the patent filed by a former member of that project, Heinrich Fleissner, we can piece together something of its design. Its identifying characteristic is its engine which has been described earlier as a turbine-ram-jet. It could operate using a variety of fuels. It could function as a jet engine within the atmosphere or convert to a rocket engine using liquid oxygen and liquid hydrogen. Its speed and altitude limits would have been much greater than either the Schriever-Habermohl or the Miethe saucers, yet its construction would have been less complex than the advanced designs of the radial-jet engines being developed in the Canada as part of the Silver Bug Program. Recognition of these facts, especially after the 1955 patent application by Fleissner, probably led to the abandonment of the A.V. Roe, Limited project(s). A cover project, the "Avro car" was released to the public, discredited by its own designers, and put away to be forgotten.

In discussing the Aftonbladet article we have jumped ahead of our story slightly in order to connect the three saucers pictures with the Fleissner saucer patent in a proper context. The Aftonbladet article has other implications which will be discussed. Now, however, we must once again return to basics in order to illustrate the next stage of saucer development envisioned by the German scientists.

Vesco makes mention of liquefied air or liquid propellants or explosives numerous times in discussing flying saucers (16)(17)(18)(19)(20). Vesco refers to saucers powered using "liquid air". On page 135-136 of Intercept UFO he says:

"After the German surrender in May 1945, when the British examined the secret papers of the technical departments of certain factories hidden in the forested area of the Schwarzwald-another region earmarked as an "island" for a last-ditch

stand-they discovered that some of the documents miraculously spared from the retreating S.S. units' destruction of papers concerned"the important experiments conducted with liquid air as a power supply for certain new types of turbine engines capable of producing tremendous power outputs. At first the discovery led them to believe that a new system for powering submarines was under study, but ancillary information about the construction of powerful apparatuses working on principle of electromagnetic waves that would make it possible to exercise radio control at great distances, as well as photographs showing some parts of the new turbine, caused them to change their minds. Thus they got on the track of a preliminary preparatory stage for a new and very powerful type of armored, radio-controlled aircraft".

Mr. Rothkugel points out that the logical projection of Vesco's statements on liquid air would involve a saucer in with air would be drawn in through the skin or through slots in the upper wing (saucer), then rapidly cooled by special equipment into liquid air. The liquid air would be burnt in a combustion chamber and the hot air and steam would be exited through a turbine used to produce the electricity which this process would require.

The saucer would be drawn along through the atmosphere by the low pressure area to its front and top as well as by aerodynamic forces caused by its wing at low speed. With the addition of more liquid air into the combustion chamber, the expansive forces involving the conversion of a liquid to a gas would provide additional performance enhancement. This amazing and little-know method was invented and patented by the Austrian Karl Novak in 1943 (21) and will work even with inert gasses. Of course, even nitrogen, sometimes considered an inert gas and which constitutes the major component of our atmosphere, can be burnt with sufficing electrical ignition as is witnessed in lightning. The cooling needed to liquify the air would be generated using acryostat, probably liquid helium. Liquid helium is the coldest of gasses, minus 452 degrees F, just above absolute zero. In addition to the cryostat, magnetic cooling machinery, such as is employed to produce liquid nitrogen would be employed (22). From the cooling power of liquid helium and evaporative techniques, liquid nitrogen and liquid oxygen can be made which are the major constituents of our atmosphere.

A saucer which could gather its fuel along the way has one obvious advantage. It could stay aloft for days if not weeks. More conventional chemical power could be employed for take-offs and landings and for bursts of speed necessary for military applications. In fact, there is no reason that the propulsion systems of the Fleissner saucer and the liquid air saucer envisioned by Vesco could not be combined into one aircraft.

It is unknown at this time if actual steps were taken to realize a liquid air powered flying saucer by the Germans. Whether it was undertaken or not it certainly did lead thinking on to the next step in this process and for this step there is more than a little evidence. This step was mentioned in the Aftonbladet article. It involves atomic power. Yes, the Germans intended to build a nuclear powered flying saucer (23).

These are the conclusions first reached by Dr. Milos Jesensky and engineer Robert Lesniakiewicz in 1998. The former author is a Czech and the latter author is a Pole. Both belong to a large UFO organization which functions in both countries. After the Soviet pullout there were no restrictions on excavation of unused military sites belonging to the Germans during the Second World War. This organization got busy interviewing witnesses who had connections to those times as well as identifying German underground facilities. They opened up as many of these as they could find, and they were numerous. Most of the Polish sites were within the borders of Germany at that time since the borders, before and during the Second World War, extended into about 20% of Western Poland. Other sites were in the heavily German dominated areas of Moravia and Bohemia, now the Czech Republic.

Of course, the Germans had taken out what they wanted before retreating and then sealed up the entrances with explosives. As an example of how far this research group was willing to go, they not only opened up and explored the upper levels of Der Riese, mentioned earlier, but also explored the flooded lower levels, in the cold, silent darkness using scuba gear. Besides Der Riese, other very large sites were discovered and explored including "Robert 1", "Robert 11", and "Robert 111".

They found that the larger sites were really composed of a complex of sites. For instance, at Der Riese some of these sites within the larger facility were involved in mining uranium ore. Some were involved in refining the ore. Some other sites were involved in nuclear research (24).

Wartime German work in nuclear research was not confined to bomb building, as it was in the USA. The Germans were also interested in harnessing the atom as an energy source. Remember, Germany was dependent upon foreign sources of oil for energy. German planners long realized this was a weakness and had been trying to correct the problem since the early 1930s. Great plans were in the works, if not actually built, for atomic reactors used to generate electricity. These were sometimes called "uranium machines" by the Germans. Not only were these uranium machines to be used to generate electricity but they were also destined to power submarines and aircraft.

Dr. Jesensky and Mr. Lesniakiewicz assembled and analyzed the great volume of evidence they had gathered over the years. They analyzed the physical evidence of the sites and interviewed as many people as possible. From the thousands of observations made and facts collected, they tried to draw conclusions. They found a close proximity and close association of the German nuclear program to the German flying saucer program. They concluded that one aim of the German nuclear program was to build a nuclear powered flying saucer (23).

There is some independent evidence supporting this conclusion. After the war, German physicist Werner Heisenberg wrote a paper concerning German interest in atomic energy. In that paper Heisenberg stated that in the summer of 1942 discussion had occurred among technical people specializing in issues of heat. This discussion concerning the handling of technical questions about the efficiency of conversion of heat from uranium to determined materials, for example, water or steam (25). It is hoped the reader would recall Dr. Giuseppe Belluzzo's specialties (materials and steam turbines) in connection to this discussion.

Further evidence can be gleaned from British Intelligence Objectives Sub-Committee Report. This report seems to follow a pattern we will see used again twice. The report does its best to discredit the informant in question, in this case a physicist and chemist, Josef Ernst, on one hand, while on the other hand the British thought it had enough merit to include this testimony concerning German research in some detail. Evidently, the intelligence agency in question is trying to cover all the bases in the event of any contingency. No matter if the scientist in question were to be cited or discredited, there would be language in the report substantiating both.

The report describes several areas of totally new German technology but what is of most importance to us here is Ernst's report of a new high speed fighter. The project designation is P-1073, and it was being developed by Messerschmitt. Three different engines were to be employed. The first was a B.M.W. 003 engine using petrol as fuel. The second engine was to use crude oil. The third aircraft was to use an atomic engine. This engine was described as 60 cms. long and 20 cms. in diameter. Ernst said it produced about 2,000 horse power! This aircraft was supposed to have a speed of 2,000 kilometers per hour (about 1250 m.p.h.) and a ceiling of 18,000 meters (over 54,000 feet). It was made at a Camp Mecklenburg. Only one model was ever made and it was destroyed, as was Camp Mecklenburg, by the SS before being taken by the Allies (26).

Establishment historians have all told us that the German atomic program was inept and disorganized. There may be some evidence for the charge that they did not share information between themselves due to strong rivalry (27) but the real facts are quite different than heretofore publicly disclosed (28). The overwhelming fact is that until now establishment historians have not had enough information to reach final conclusions about the German atomic program. Many facts have been concealed and these facts are only now being brought into the open. One fact is that there were even more German atomic programs than previously known, and the fact is that one of these programs was run by the SS (28).

## German Atomic Aircraft

British Intelligence Objectives Sub-Committee Report Number 142

### C. Interrogation of Josef Ernst

In the course of interrogation it became clear, that Ernst was not at all reliable, and though there may in some cases be a factual basis for some of his claims, they are as a whole inaccurate and of doubtful value.

#### (a) Personal history of J. Ernst

Ernst's own account of his life did not agree with the details which were extracted from a file in his possession, and which are given below. He was born at Malsch, near Ettlingen in 1899, and claims to be a physicist and chemist. He became a teacher, but was removed from his position in 1923 for dishonesty and then tried to make a living by obtaining financial backing for various inventions which he claimed to be capable of developing. He was eventually charged with obtaining money by false pretences and imprisoned at Mannheim in 1944. Here he claimed that he had a process of obtaining petrol from oil, and was brought to Berlin by the S.S. Hauptamt under the charge of Kreutzfeld. After spending some time in hospital, he was ready to begin work, and in April 1945 was brought to Hinterstein, near Sonthofen, again under the charge of Kreutzfeld.

#### (a) High speed fighter aircraft

Ernst said that while he was in Camp Mecklenburg, he found out that there were three new types of high speed fighter aircraft. One of these was the P 1073, made by Messerschmidt with a B.M.W. 003 engine using petrol as fuel; and the second was a similar aircraft using crude oil as a fuel. The third was alleged to be powered with an atomic engine. The fuselage, which was the same as the P 1073, was of wooden construction and was fitted with skid landing gear. The engine was 60 cms. long and 20 cms in diameter, and produced about 2,000 h.p. This aircraft was supposed to have a speed of 2,000 km./hr. and a ceiling of 18,000 m. The engines were made by the prisoners at Camp Mecklenburg. Only one model was ever in existence; and that was completely destroyed, as was the whole camp, by the S.S. during the Allied advance.

Top: British efforts to accredit and discredit their informant, Josef Ernst. This theme appears repeatedly in Allied documents in association with German informants. The intelligence people were merely covering themselves for all eventualities. Bottom: A German atomic airplane built at Mecklenburg. The Mecklenburg facility utilized some personnel which were considered to be a security risk.

One establishment historian, Thomas Powers (29), perhaps unwittingly gives us some insight into the discussion at hand, Powers concentrates on the historical sequence of the German atomic program and with the people involved and their relationships with one another. He also follows the progress of the many organizations researching atomic physics for the purposes of energy production and bomb making. Powers documents six such groups.

One group concerns this discussion. It was run by the Heereswaffenamt or Army Weapons Department. Its Director of Research was Dr. Erich Schumann who was also the scientific advisor to Field Marshal Wilhelm Keitel. Schumann was a

professor of military physics at the University of Berlin. He also held a commission in the army so with these credentials he was able to move comfortably in both academic and military circles. Schumann should be thought of as an administrator rather than a research scientist (30).

The field of research was left to Dr. Kurt Diebner (31). Diebner was a physicist for the Heereswaffenamt since 1934 and headed his own atomic research project. German physics during the war years was geared towards practical results. During the early phases of the war it was thought that nuclear weapons were unnecessary. The thinking at the time was that the war could be won without atomic bomb using conventional weaponry. Therefore, work on atomic weapons was de-emphasized in the early years of the war. Work on atomic means of energy production was always a high priority, a priority which only got higher as the war drew to a conclusion.

Germany always felt more threatened by dependence upon foreign sources for energy. Therefore, harnessing the energy potential of the atom for an ongoing source of energy was always a concern for German atomic scientists, much more so than for the Americans. This aim is clearly mentioned in discussion among the scientists involved in the work.

In early 1942 the success of Diebner's reactor experiments led him to propose a full-scale effort to develop both power-producing machines and atomic bombs. He continued to pressure Schumann who was more pessimistic about the possibilities of bringing this research to a practical result. Schumann finally became convinced and agreed to give a presentation to top Nazi officials of their findings. The text of Schumann's speech was to stress the more conservative energy production aspect of atomic research rather than the building of a bomb. This was considered more feasible and so gives us an insight into the German atomic program and its thinking (32).

One example of their optimism was the participation of Diebner in plans for building an atomic power plant for Germany's submarine fleet. The year 1945 was mentioned as a target date for this to happen (33)(34).

Diebner's relationship to Schumann is made clear by Powers. Powers also introduces us to two additional players who were not officially involved with this project but who somehow interject themselves into things making their view heard.

The first is industrial physicist, Carl Ramsauer. Ramsauer was the head of the German Physical Society and a leading researcher for the electrical firm Allgemeine Elektrizitätsgesellschaft. Ramsauer urged the German research establishment to rid itself of ethnic physics and get down to the business of using science to win a war (35).

A second scientist interjected himself into the fray in support of Ramsauer. This was none other than Ludwig Prandtl whom we have met earlier (36). Prandtl was familiar with the potential of fission's use in the war effort and insisted that the Nazis let scientists do science without reference to ethnic background or politics. Why was German atomic research so important to an industrialist involved in aeronautics? What aims did Prandtl have in common with these other individuals which linked them together? What was the urgency that compelled Ramsauer and Prandtl to intervene in a matter outside their areas of expertise and in opposition to the will of Nazi officials?

To answer those questions, let us look at each individual involved and his major area of interest. Professor Erich Schumann's interest was the military application of atomic energy. Dr. Kurt Diebner's interest was the development of atomic energy for nuclear weaponry as well as for a variety of other applications. As an industrialist, Carl Ramsauer's expertise was putting technology into large-scale, practical, production. In this time and place that meant military production. We already know that Professor Ludwig Prandtl's interests were round-wing, suction aircraft. The interests of these four could only coincide if we were discussing the military-industrial production of a nuclear powered, round-wing, suction aircraft.

In addition, it is now known that Dr. Diebner, more than any other well known German scientist, was at the heart of the German atomic bomb development. It was Dr. Diebner who participated in the development of a German uranium bomb which was being prepared in one of the underground facilities at Jonastal, specifically at a facility "Burg". Not only did Dr. Diebner do this but he did this within a working association with the SS atomic research team mentioned above (37). This SS connection runs back to Prag, the Skoda Works and the Kammler Group who held knowledge and control of every truly innovative weapons system being developed by the Third Reich including those at Peenemuende. As we know, this included the development of flying discs. The association of the facilities in and around Prag, the Kammler Group, atomic energy and German flying discs has been made by other researchers using other evidence (38). This connection seems very strong.

## **Truth Is Stranger Than Fiction**



# NAZIS HAD 10,000 mph ATOM PLANE—IN THEORY

MANY of Germany's inner secrets had been unlocked by the United States and Britain and were being adapted for the war in the Far East when the Japanese surrendered.

MORE THAN 200 BRITISH AND AMERICAN TECHNICAL EXPERTS FOLLOWED HAARD ON THE WHEELS OF THE INVADING ARMIES IN EUROPE TO TRACK DOWN SECRETS, HOWEVER WELL HIDDEN, BY THE GERMANS.

The thoroughness of the search in Germany foreshadowed a similar probing for secrets now locked in Japan.

This is revealed in a statement issued on behalf of the Combined Intelligence Objectives Sub-Committee and the Technical Intelligence Committee—secretive authorized by the British and United States Chiefs of Staff—and published by the British Ministry of Information and United States Office of War Information.

Discoveries show that German invention was far ahead of her capacity to translate theory into industry.

Not only had the Germans made significant progress in the development of the atomic bomb and on the production of heavy water, but they had constructed a pilot plant with a possible range of 1,000 miles.

The design investigated commercial applications for trans-Atlantic passenger crossings in 17 minutes. The Germans were working on a formula for new war gases which would be used in a more deadly than any chemical agent yet developed.

## DETAILS FOR NEWER NAVAL VESSELS

They had specifications and construction details for naval vessels of advanced design, including submarines with high underwater speeds and apparatus for sustained underwater operations.

They had developed a system of anti-radar equipment, consisting of anti-radar screens and coatings to be employed on submarines and other weapons and had highly advanced jet engines, rocket-assisted take-off, and aerodynamic designs.

New uses had been found for many staples and from coal the Germans were making synthetic butyl as well as alcohol of both beverage and industrial types, aviation lubricants, soap and petrol, and they had designs for various secret types of guns and projectiles.

Other German work was derived from records on the location of German capital in neutral countries and the status and composition of German armies, specifications of long-range rocket developments which scientists described as "exceptional."

The information gathered is not only valuable in the shaping of the policy for control of Germany but is expected to influence post-war scientific and industrial developments.

## BOMBER CHIEF RETIRING

Air Chief Marshal Sir Arthur T. Harris, 41, Chief Commander-in-Chief Bomber Command since February, 1942, will relinquish his appointment next month, and shortly afterwards retire from the Air Force, announce the Air Ministry.

He will be succeeded by Air Marshal Sir Norman Bottomley, present Deputy Chief of Air Staff.



## 999 Was His Unlucky Number

THREE unlocked took in London to have written six months in Wandsworth Jail and still finds it difficult to understand how he landed there.

When he left a "Puckton" house by the back window carrying a suitcase filled with silverware, jewelry and cloths, a police car was in the road of the road.

His capture was a result of the new radio "telemetry" system—sending all cars—which is being introduced by British Road Traffic Police, was caught during a "dummy" run in South London.

A housewife dialled 999 and found herself speaking to the information room at Scotland Yard. The quick-witted inspector switched a police car which was on the road and the burglar was under arrest here, minutes and twenty-five seconds later.

Scotland Yard hopes for a big decrease in London crime through the introduction of the new system.

Although all of London will not be covered at first, supplies of the necessary radio parts are now coming in, and Chief Inspector Rowman of the Yard's Communication Branch, who completed the work he began in 1938.

Every patrol car, flying squad car and Q car—taxi and revenue vans equipped—will soon be in radio-telephonic communication with the Yard's central information control room.

Every patrol car, flying squad car and Q car—taxi and revenue vans equipped—will soon be in radio-telephonic communication with the Yard's central information control room.

Every patrol car, flying squad car and Q car—taxi and revenue vans equipped—will soon be in radio-telephonic communication with the Yard's central information control room.

Every patrol car, flying squad car and Q car—taxi and revenue vans equipped—will soon be in radio-telephonic communication with the Yard's central information control room.

Every patrol car, flying squad car and Q car—taxi and revenue vans equipped—will soon be in radio-telephonic communication with the Yard's central information control room.

Every patrol car, flying squad car and Q car—taxi and revenue vans equipped—will soon be in radio-telephonic communication with the Yard's central information control room.

Every patrol car, flying squad car and Q car—taxi and revenue vans equipped—will soon be in radio-telephonic communication with the Yard's central information control room.

Every patrol car, flying squad car and Q car—taxi and revenue vans equipped—will soon be in radio-telephonic communication with the Yard's central information control room.

Every patrol car, flying squad car and Q car—taxi and revenue vans equipped—will soon be in radio-telephonic communication with the Yard's central information control room.

Every patrol car, flying squad car and Q car—taxi and revenue vans equipped—will soon be in radio-telephonic communication with the Yard's central information control room.

Every patrol car, flying squad car and Q car—taxi and revenue vans equipped—will soon be in radio-telephonic communication with the Yard's central information control room.

Every patrol car, flying squad car and Q car—taxi and revenue vans equipped—will soon be in radio-telephonic communication with the Yard's central information control room.

Every patrol car, flying squad car and Q car—taxi and revenue vans equipped—will soon be in radio-telephonic communication with the Yard's central information control room.

Every patrol car, flying squad car and Q car—taxi and revenue vans equipped—will soon be in radio-telephonic communication with the Yard's central information control room.

Every patrol car, flying squad car and Q car—taxi and revenue vans equipped—will soon be in radio-telephonic communication with the Yard's central information control room.

Every patrol car, flying squad car and Q car—taxi and revenue vans equipped—will soon be in radio-telephonic communication with the Yard's central information control room.

Every patrol car, flying squad car and Q car—taxi and revenue vans equipped—will soon be in radio-telephonic communication with the Yard's central information control room.

Every patrol car, flying squad car and Q car—taxi and revenue vans equipped—will soon be in radio-telephonic communication with the Yard's central information control room.

Every patrol car, flying squad car and Q car—taxi and revenue vans equipped—will soon be in radio-telephonic communication with the Yard's central information control room.

Every patrol car, flying squad car and Q car—taxi and revenue vans equipped—will soon be in radio-telephonic communication with the Yard's central information control room.

Every patrol car, flying squad car and Q car—taxi and revenue vans equipped—will soon be in radio-telephonic communication with the Yard's central information control room.

Every patrol car, flying squad car and Q car—taxi and revenue vans equipped—will soon be in radio-telephonic communication with the Yard's central information control room.

Every patrol car, flying squad car and Q car—taxi and revenue vans equipped—will soon be in radio-telephonic communication with the Yard's central information control room.

# Gen. McCreery Arrives For Vienna Talks



The Allied Commanders in Austria met recently in Vienna. The British Commander, Lt.-Gen. Sir Richard McCreery, is seen at the British airfield at Vienna, above, with Gen. Sir Bernard Montgomery (right) and Lt.-Gen. Sir Douglas Grahame (left). The German Commander, Lt.-Gen. G. von Soden, is seen at the German airfield at Vienna, below, with Gen. Sir Bernard Montgomery (right) and Lt.-Gen. Sir Douglas Grahame (left).

## THREAT OF 'UNBEATEN JAP ARMY'

FRANK of a Japan still believing, in spite of defeat, in its glorious destiny and the invincibility of its army, with the Japanese General Staff "going in ground" as did the German staff in 1918, was expressed by The Times yesterday.

In the circumstances of the Japanese people the paper urged the honest application to South-east Asia of the principles of San Francisco.

The circumstances of the Japanese surrender, the paper observed, imposed upon the Allies the necessity for extreme caution.

ARMY DEFEATED IN 'REMOTE' AREA

While the Japanese navy and air forces have been almost annihilated and the civil population has been subjected to the hardships of Allied might, the land forces have sustained their main defeats in areas remote from public observation.

Large bodies of Japanese troops will return home with an other experience than that of victory and many Japanese commanders of overseas territories will return with truth that they surrendered not to Allied armies, but in deference to Imperial rescript.

The way is thus open for the propagation of the myth which proved so formidable a factor in the rise of the Third Reich—that the Army had never been conquered and that the war was lost by poor civilian morale caused by the Allies employing "inferior" weapons.

The Allies are expected to add to their civil authorities in exposing this dangerous myth.

The prevailing view from the Emperor downwards is regarded as regarding the nation that the imperial prerogative remains intact and the destiny of Japan glorious.

The Daily claims that the real reason for the defeat is the demoralization of the minds of the Japanese people.

There are two main influences which may be expected to counter-balance this tendency to such conversions.

First is the application to South-east Asia of the principles of the San Francisco Charter and second a spectacle of unity once the United Nations are united in their declared aims.

One of the contributory motives of Japanese aggression has been a deep resentment at the disposition of the Western Powers to treat the Asiatic peoples as third-class.

WHERE TO DITCH 'EMT AGAINST WEST

Japan desired to unite the East against the West under her own leadership and for this purpose invaders had to be sent to the West.



## The Russians Are To Quit Manchuria In 3 Months

UNDER the terms of the treaty between China and the Soviet, published simultaneously in Chungking and Moscow during the week-end, Russia is to render military and material assistance in the Chungking central government of China in a plan of collaboration to prevent a repetition of Japanese aggression.

Reaffirming respect for China's full sovereignty in her three eastern provinces, Stalin has given an assurance that after the Japanese capitulation the Russian forces will withdraw from Manchuria within three months.

In the case of Sinkiang, Russia reiterates that she has no intention of interfering in Chinese internal affairs while China is to recognize the independence of Outer Mongolia if the protests prove that the people so desire.

The trunk line of the Chinese eastern and north Manchurian railways will be combined into one jointly-owned and operated line known as the Chinese-Chinese railway for a period of 20 years after which it is to revert to China.

China has been assured a first post by the Chinese Government and for 20 years Port Arthur will be a joint Chinese-Russian naval base.

Although the Chinese Government are not specifically mentioned, the treaty is regarded in Chungking as a political defeat for them at a particularly difficult time.

NO CIVIL WAR

It is the impression in London political circles that the recent conversations between the Chinese Prime Minister, Dr. T. V. Soong, and Generalissimo Stalin have notably reduced the risk of civil war in China.

People in the Manchurian villages of Long Buckby are speaking to each other again how that Japan has surrendered.

Their war started on VE-Day, when it was found that the parson council had not arranged any celebrations.

Jack Cooper, secretary of the local Corners Fund, Fred Bidwell, the village schoolmaster and Home Guard, Bill Coleman, the chimney sweep and Bob Blincoe, bootmaker, got together and with many more helpers arranged VE celebrations 23 days late.

## Peace In Long Buckby, Too

People in the Manchurian villages of Long Buckby are speaking to each other again how that Japan has surrendered.

Their war started on VE-Day, when it was found that the parson council had not arranged any celebrations.

Jack Cooper, secretary of the local Corners Fund, Fred Bidwell, the village schoolmaster and Home Guard, Bill Coleman, the chimney sweep and Bob Blincoe, bootmaker, got together and with many more helpers arranged VE celebrations 23 days late.

People in the Manchurian villages of Long Buckby are speaking to each other again how that Japan has surrendered.

Their war started on VE-Day, when it was found that the parson council had not arranged any celebrations.

Jack Cooper, secretary of the local Corners Fund, Fred Bidwell, the village schoolmaster and Home Guard, Bill Coleman, the chimney sweep and Bob Blincoe, bootmaker, got together and with many more helpers arranged VE celebrations 23 days late.

People in the Manchurian villages of Long Buckby are speaking to each other again how that Japan has surrendered.

Their war started on VE-Day, when it was found that the parson council had not arranged any celebrations.

Jack Cooper, secretary of the local Corners Fund, Fred Bidwell, the village schoolmaster and Home Guard, Bill Coleman, the chimney sweep and Bob Blincoe, bootmaker, got together and with many more helpers arranged VE celebrations 23 days late.

People in the Manchurian villages of Long Buckby are speaking to each other again how that Japan has surrendered.

Their war started on VE-Day, when it was found that the parson council had not arranged any celebrations.

The 8th Army News, Trieste, August 28, 1945, page three. For a short period of time, before the Cold War started heating up, censorship, both military and civilian was lax. It is from this time period from which we get much valuable information

The Germans were planning an nuclear powered flying saucer just as they were planning a nuclear powered submarine. The proof for both of these claims is the fact that the Americans discovered such plans, further developed them with captured German scientists, and built them in America after the war. We already know about the nuclear submarine and proof of American plans to build a nuclear flying saucer based upon German ideas has just been revealed.

Jim Wilson, writing in the November, 2000 edition of Popular Mechanics discloses something of major importance. Wilson tells of the days following the collapse of the 3rd Reich and a rumor which had begun circulating in Allied military

intelligence circles. Interrogations of captured German aircraft engineers pointed to the development of a super-fast German rocket fighter at a secret base in Bavaria (the reader will recall the research aircraft 8-346 and P-073 mentioned earlier). This aircraft, according to Wilson's article, featured odd looking curved wings which blended into the fuselage.

Documents obtained by Wilson point to an American secret saucer project, separate and parallel to Project Silver Bug, of German inspiration and involving captured German personnel. This project, called the Lenticular Reentry Vehicle (LRV), was a flying saucer designed to carry four nuclear tipped missiles into earth orbit for a mission duration of six weeks at a time. The saucer had a four man crew, was forty feet in diameter and was powered by a combination of chemical rocket engines and nuclear power (39).

The chemical engines were the hypergolic rocket engines of the same type as employed by the Germans during the war in the Me-162 rocket interceptor and referred to earlier.

Besides the chemical rocket engine, two atomic engines were employed as atomic rockets. In this type of engine a liquid gas (perhaps liquid air as described above) which is very cold, is passed through the atomic reactor or passed through a radiator of molten metal heated by the reactor. The liquid gas turns to vapor instantly and is accelerated out the rear of the rocket at a greater velocity than can be obtained by burning two liquid gases, for instance, hydrogen and oxygen. Although a shielded nuclear reactor is certainly heavier than an air-cooled aero-engine, there might be an overall weight savings as compared to a conventional liquid rocket system since a liquid oxidizer, such as liquid oxygen, need not be carried on the vehicle. The atomic engine would also produce electricity for the saucer using this expansive output coupled to a turbine generator.

### **How An Atomic Rocket Works**

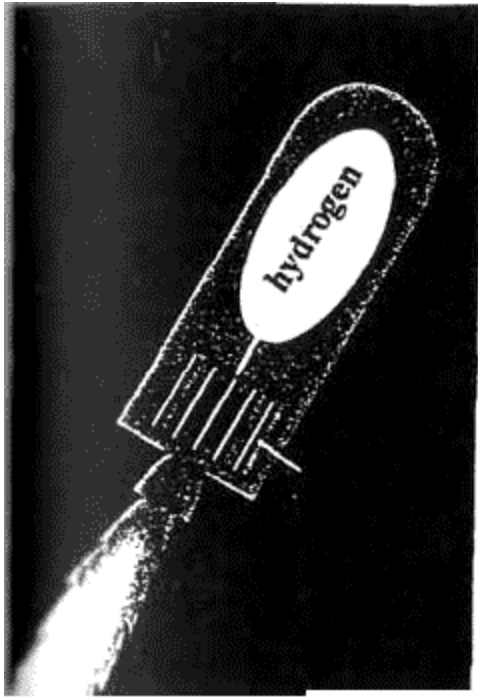

Nuclear Gas Core Reactor

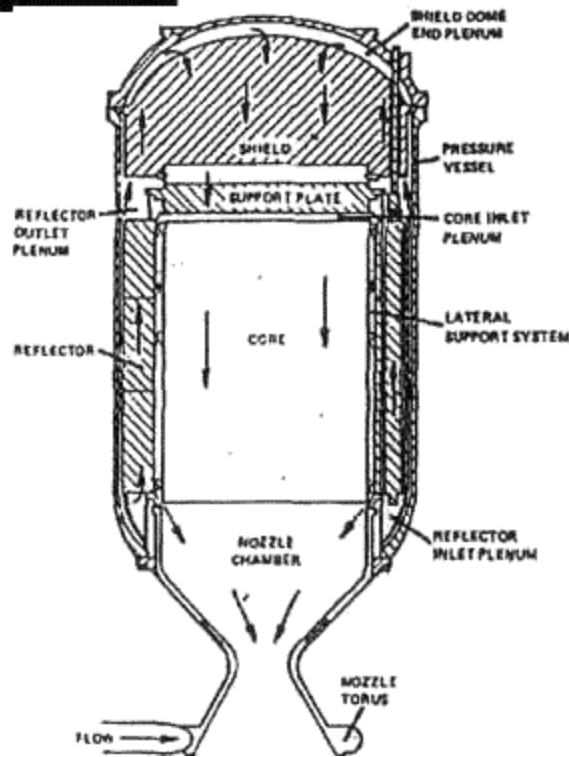

TYPICAL ROCKET  
PROPULSION  
REACTOR

Top: The simple story is that hydrogen is passed through or by an atomic reactor. The very cold liquid hydrogen is instantly heated and greatly expands, providing thrust for the rocket. No actual combustion occurs and no oxidizer is needed.  
Bottom: A detailed look at the reactor itself.

Wilson cites some evidence that this saucer was built and actually flew (40). Orbiting at an altitude of 300 miles and with a six week mission, this saucer was in reality an orbiting space station capable of raining destruction down upon any country or countries deemed an enemy. One can extrapolate a rotation system by which such a dreadnought was always kept on station for such a contingency. Klaus-Peter Rothkugel has suggested that an orbiting doomsday space station such as this was to be called the "Gatland Space Station" and that it was part of a strategic military joint-effort between the United States, Britain, Canada and perhaps Australia. Before the Popular Mechanics revelation, this assertion might have been dismissed as lacking in proof but now this idea must be given a hearing.

Wilson states that project's general contractor was North American Aviation in California but the project was managed out of Wright-Patterson Air Force Base in Ohio where German engineers who worked on rocket plane and flying disc projects were housed under secret contract with the United States government (41).

The Popular Mechanics article is based upon information obtained from working on the American perspective and going back in time. The Freedom Of Information Act was very skillfully employed in obtaining this information. What Mr. Wilson did not know was what the reader knows now, that there is a trail of information leading to the American nuclear saucer project which started in Germany in the 1930s. One example which links both lines of evidence and bringing them full-circle back to the German origin is one report recently obtained via FOIA on a particular German scientist working at that Wright-Patterson facility.

This is a December, 1946 report written by one of those captured German scientists working under contract for the USA, Dr. Franz J. Neugebauer, titled "Effect Of Power-Plant Weight On Economy Of Flight (Project No. NFE-64). Dr. Neugebauer was, in fact, one of those "booty scientists" brought to the USA under the auspices of Operation Paperclip. The Biographical Note in the report, "Effects Of Power-Plant Weight On the Economy Of Flight", describes Dr. Neugebauer as:

"Dr. Franz J. Neugebauer is the foremost German authority on this subject. An Expert on internal-combustion engines and a specialist for Diesel compound aircraft engines, he held leading positions at Junkers in Dessau and Munich from 1924 to 1943, and was director of the engineering department of the Institute for Aeronautical Research at Munich from 1943 to 1945.

Dr. Neugebauer is employed at present in the Propulsion Section, Analysis Division, Intelligence (T-2), MAC, Wright field, Dayton, Ohio" (42).

Two comments are in order. The first is that Junkers-Dessau is associated with a possible German saucer project designated "Schildkroete" which will be discussed later. The second comment is that Dr. Neugebauer was not brought to the USA to build diesel-powered aircraft. Diesel engines are much heavier than piston type aero-engines of those times. Dr. Neugebauer's relevant expertise is, in reality, his knowledge of the effects of heavy engines on aircraft performance and economy.

Nowhere in this report are the words "atomic rocket" mentioned but the implications are clear. As touched upon above, an atomic rocket's weight distribution would be somewhat different from that of a conventional rocket or aircraft. The nuclear reactor would be weighty but the fuel load would be lighter because no oxidizer, such as liquid oxygen, would be necessary. Also, the power output would be somewhat greater than an ordinary liquid fuel chemical rocket. The three variables as opposed to the already known figures for piston, jet or chemical rocket engines are greater engine weight, lesser fuel weight, and greater power output. A new equation was necessary if atomic rockets were to be fitted into an aircraft design calling for a certain speed, payload or range. It was Dr. Neugebauer's job to do this computation.

The following is a paragraph from the introduction of this report(43). It seems to say nothing but state the obvious until one thinks "atomic engine":

"Power-plant weight is a factor which affects flight performance; the greater the weight, the greater is that portion of the airplane and the drag which is affected by the power plant. In contrast to the effect of fuel consumption, the effect of power- plant weight cannot be easily determined. For example, it cannot be easily determined whether a certain reduction of fuel consumption is still advantageous if it involves an increase in power plant weight. This report aims to facilitate insight into these and similar questions."

Without ever mentioning the word "atomic", Dr. Neugebauer did the mathematical computations necessary to establish the feasibility of an atomic powered aircraft. Thanks to the work of Mr. Wilson, we know that at least advanced planning was undertaken with the goal of building an atomic powered flying saucer. There is no doubt that the Americans would not have involved captured German scientists in this project unless it was absolutely necessary to do so. The reason it was necessary was the same reason which other German scientists were employed in America's ballistic missile program. It was because both groups of German scientists has previous experience. Both groups worked on very similar projects in Germany during the war. These scientists and their projects were far ahead of the Americans in both these areas. The input of these scientists was absolutely essential if these projects were to succeed in a timely matter, meaning, ahead of the Soviets.

Two final points or comments should be added to this discussion. First, while the Peenemuende saucer project was run in and around Peenemuende, research and component work were probably also done in other facilities elsewhere within the

Greater Reich. References to saucer research at some of these other sites by this or other writers may be, in fact, part of the overall Peenemuende project.

Second, historically speaking, the German atomic projects have always been minimized to say the least. For whatever reason, there seems to have been a concerted effort to deny German expertise in the field of atomic energy. Originally, this may have been government inspired. Now, however, it seems to be a mantra taken up as part of some agenda whose specifics remain clouded. "Nay-saying" regarding German atomic projects has become sheik and those who expound it imply knowledge and sophistication in their opinions. Anyone doubting the high degree of understanding possessed within the Third Reich concerning matters "atomic" should take a look at the evidence being put forth by on-site investigators and German language researchers which have arisen since the fall of the Berlin Wall. Much of this information is in book form available from Anum Verlag. Anyone with the interest and ability to read German language is urged to contact this publisher for a list of publications. After reviewing the evidence, German wartime expertise in atomic research sounds much less far-fetched than the nay-sayers would have you believe.

## The Peenemuende Project

### Sources and References

1. Pretsch, J., date unknown, "Umschlagbeginn und Absaugung EinBreitrag zur Grenzschichttheorie", Report of the Aerodynamic Research Facility at Goettingen
2. Betz, A., 1961, page 6
3. Kinner, Wilhelm, 1936, "Ueber Tragfluegel mit Kreisfoermigen 110
4. Grundriss", Vortraege der Hauptversammlung in Dresden, Band 16, Heft 6,
5. Hansen, M., 1938, "Messungen and Kreistragflaechen undVergliech mit der Theorie der tragenden Flaeche", Vortraegeder Hauptversammlung in Goettingen
6. Miranda, J. and P. Mercado, 1998, page 4, "DeutscheKreisfluegelflugzeuge", Flugzug Profile
7. Rothkugel, Klaus-Peter, 2000, pages 1 and 2, "Dr. Alexander Lippisch der "Vater" der "fliegenden Untertassen", privately published information sheet
8. Sandner, Reinhardt, 1980, page 3, "Der Vater der fliegendenUntertasse 1st ein alter Ausburger", Neu Presse, number 19/17
9. ibid
10. U.S. Patent, Number 2,939,648, Granted June 7, 1960 filed March 28, 1955, United States of America granted to H. Fleissner, "Rotating Jet Aircraft With Lifting Disc Wing AndCentrifuging Tanks"
11. British Objectives Sub-Committee Report Number 143 "Information Obtained From Targets Of Opportunity In The Sonthosen Area, pages 4 and 5, 32 Bryanston Square, London
12. Combined Intelligence Objectives Sub-Committee Evaluation Report Number 289, 1945, Interrogation of Drs. Julius Schmitt, Ludwig Schmitt, and Heinrich Schmitt, of Dr. Heinrich Schmitt-Werke, K.G. Berchtesgarden
13. Kadmon, 2000, Ahnstern IX "Andreas Epp", Aorta c/o Petak Postfach 778, A-1011, Wien, Austria
14. Vesco, Renato, 1976, page 93, Intercept UFO, Pinnacle Books New York
15. Vesco, Renato, 1976, pages 135-136
16. Vesco, Renato, 1976, page 164
17. Vesco, Renato, 1976, page 168
18. Vesco, Renato, 1976, page 163
19. German Patent, 1943, Karl Nowak, German Patent Number 905847 Class 12g, Group 101, Subsequently issued by the German Federal Republic on March 8, 1954. "Verfahren und Einrichtung zur Aenderung von Stoffeigenschaften Oder Herstellung von stark expansionsfaehingen Stoffen" (English translation: Method and Arrangement to the change from material properties or production of strong expansive capable matter)
20. Van Norstrand's Scientific Encyclopedia, 1954, pages 453-454 and 978-979.
21. Jesensky, Milos PhD. and Robert Lesniakiewicz, 1998, pages 51, 146, 151, "Wunderland" Mimoszemske Technologie Treti Rise. Aos Publishing
22. Jesensky, Milos PhD. and Robert Lesniakiewicz, 1998, pages 41-43.
23. Heisenberg, Werner PhD., 1946, page 327, "Ueber die Arbeit zur technischen Ausnutzung der Atomkernenergie in Deutschland" (In English: Concerning the Work Toward the Technical Exploitation of Nuclear Energy in Germany) courtesy of Mr. Klaus-Peter Rothkugel

24. British Intelligence Objectives Sub-Committee Report Number 142, 1946, page 8, "Information Obtained From Targets Of Opportunity In The Sonthofen Area", London, courtesy of Friedrich Georg
25. Georg, Friedrich, 2000, page 222, Hitlers Siegeswaffen Band
26. Luftwaffe und Marine Geheim Nuklearwaffen des Dritten Reiches und ihre Traegersysteme, Anum Verlag, Schleusingen and Heinrich-Jung-Verlagsgesellschaft, mbH, Zella-Mehlis
27. Georg, Friedrich, 2000, pages 125, 154.
28. Powers, Thomas, 1993, Heisenberg's War The Secret History Of The German Bomb, Alfred A. Knopf, New York
29. Powers, Thomas, 1993, pages 130, 131, 132, 136, 137
30. Powers, Thomas, 1993, pages 131, 132, 135, 325
31. Powers, Thomas, 1993, pages 136, 138
32. Powers, Thomas, 1993, page 325
33. Georg, Friedrich, 2000, pages 188-190
34. Powers, Thomas, 1993, pages 131, 137, 143, 317
35. Powers, Thomas, 1993, pages 131, 137, 317, 416
36. Georg, Friedrich, 2000, page 125
37. Jesensky, Milos PhD., and Robert Lesniakiewicz, 1998, pages 146, 151,
38. Wilson, Jim, 2000, Popular Mechanics, "America's Nuclear Flying Saucer"
39. Wilson, Jim, 2000, page 71
40. Wilson, Jim, 2000, page 68
41. Neugebauer, Franz J. PhD., 1946, page 1

## [Section Index](#)

## [Index](#)

## Section 3 Summary

It can be said that the German flying disc program built upon itself, each innovation retaining something from a previous design yet incorporating a new innovation. This progressed through several steps until the original had seemingly nothing in common with final design. At each step a saucer project or at least a saucer design, seems to have been spun off. Each of these spin-offs was not an independent, stand-alone project but remained under the guidance and direction of an overall controlling authority. If viewed out-of-context, the multiplicity of designs and spin-offs have led to confusion concerning the whole. Proponents of each design or spin-off have championed the project with which they were familiar as "the" German saucer project. Let us try to keep idea in mind when discussing the next group of saucers which may or may not have had a relationship to those already discussed.



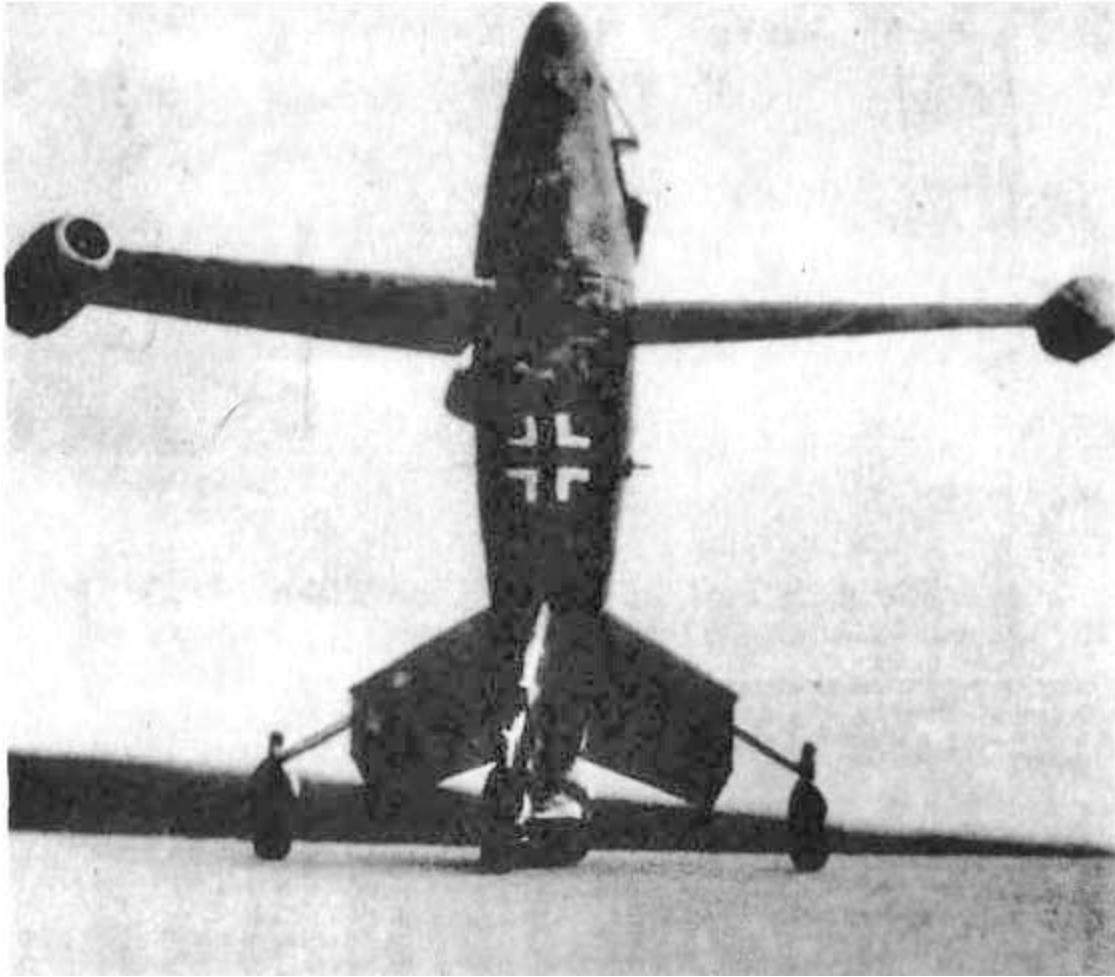

Top: Diagram of the Scriever-Habermohl flying disk. Bottom: The Focke-Wulf powered wing design with three Lorin ramjet engines. The required initial velocity was to be provided by rockets mounted in the engines.

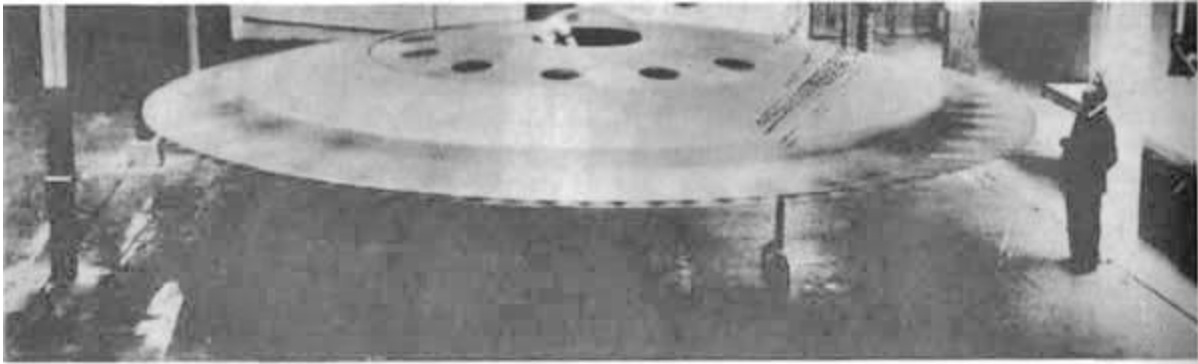

Top: These photos of French aerospace designer Rene Couzinet's flying saucer with a diameter of 27 feet appeared in the Philadelphia Inquirer on July 5, 1955. He died in a sudden auto accident shortly afterward. Left: The famous Darmstadt Saucer, a photo taken in August 1953 near the German city of Darmstadt.



IGOR WITKOWSKI

# *SUPERTAJNE BRONIE HITLERA*

część 3



Pekka Lahtinen

# Ufojen arvoitus ratkeaa

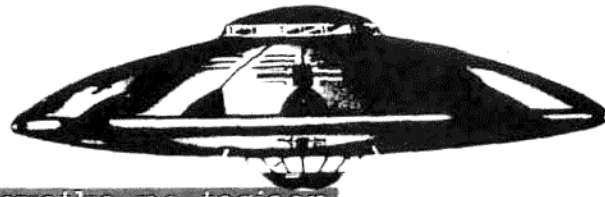

Tulevatko ne tosiaan  
ulkoavaruudesta vai  
voiko kyseessä olla  
ihmisen oma keksintö?  
Entä pienet vihreät  
miehet?



A Finnish language book on Hitler's secret weapons, including saucer and cylindrical aircraft

[Section Index](#)

[Site Index](#)

CHAPTER FOUR:

## THE GERMAN FIELD PROPULSION



### PROJECTS

- [THE VICTOR SCHAUBERGER MODELS](#)
- [THE KM-2 ROCKET](#)
- [FIELD PROPULSION SAUCERS](#)
- [Atomic Saucers Again](#)
- [The Karl Schappeller Device](#)
- [Chapter Summary](#)

This type of flying vehicle would lift and move itself powered by an electric, magnetic, diamagnetic or ether field which repels earth's magnetic field or overpowers the effects of gravity.

## The Viktor Schauberger Models

An Austrian, Viktor Schauberger was first and foremost a naturalist. His primary focus was water as found in naturally occurring streams, rivers and lakes. In observing the movement of water he formulated his own ideas about its movement and energetic properties. They are applicable in air also. His ideas are quite contrary to accepted ideas, both then and now and are even now imperfectly understood and debated. These ideas involved the vortex which was the way Schauberger believed that water naturally flowed both in the earth and in streams. Schauberger believed that energy naturally flowed in a vortex but that this movement was only visible through another medium such as water or air. This discussion will first focus on theories of why and how the Schauberger saucer model flew and then recount the sequence of events in Schauberger's involvement with flying discs.

Viktor Schauberger's saucer models incorporated a vortex in which air entered at the top and flowed right through the center of the saucer. Schauberger's vortex was an open system. A whirlpool or tornado or hurricane are examples of the kind of vortex upon which Schauberger's ideas are based. There are two directions of vortex movement, centripetal or inward moving vortex and centrifugal or outward moving vortex. Centripetally moving, that is inwardly moving spiraling air or water, takes up less space and is cooled by this motion according to Schauberger (1). The example we see in daily life is the motion of water in a toilet after flushing. He called this centripetal movement "implosion". Implosion was always accompanied by explosion as the fluid expanded again in an outward, centrifugal spiral. The process is first centripetal then centrifugal.

The form this vortex took is really dictated by function according to Schauberger. The "function" is the energy flow. The spiral vortex is the shape the energy flow takes in its movement (2). Energy flows in at the top of the vortex in the characteristic double-spiral manner. These air molecules are imploded, that is, they are made more dense and they yield heat as they progress (3). Air molecules are squeezed tighter and tighter together as they move down the vortex until the sub-atomic particles themselves become unglued transforming into new and unrecognized forms of energy (4). As the vortex itself decreases in diameter implosion and speed are increased until they reach the point within the vortex where centripetal forces stop and centrifugal forces take over.

### Viktor Schauberger's Saucer Models

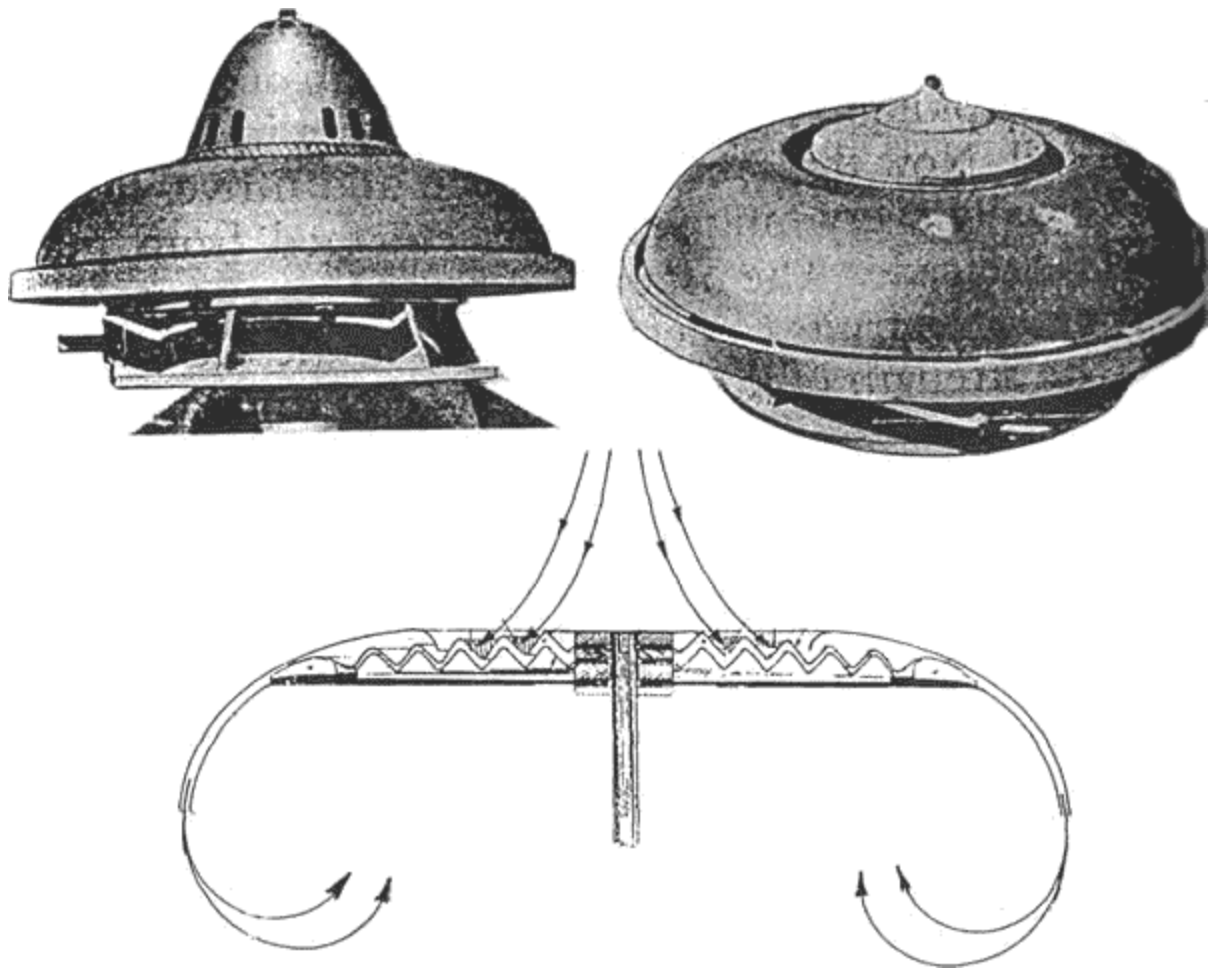

Top: Schauberger models. Bottom: Sectional diagram. The zig-zag is the air passage. The passage is a hollow space between two plates. As the saucer spins on its axis, the air enters and moves away from the center toward the rim following the up and down flow of the zig-zag. The spin causes individual tornado-like vortices to form as the spin causes the air flow to fold over on itself as it moves outward. Vortices become smaller in diameter and more "densified" until they reach the rim where they are released into the atmosphere, rapidly expand, and yield energy. Model is multi-section, copper. Courtesy Klaus-Peter Rothkugel

Energy is radiated out from the center of the vortex (5). The Schauberger vortex may be visualized as a figure "8" according to Dr. Gordon Freeman, with the energy radiating out at the narrow mid-point between the upper and lower loops (6). This energy produces levitation. It may be diamagnetic energy as Schauberger believed (7).

Viktor Schauberger first built new designs for flumes to transport logs. He then built water purification machines using the principle of the vortex. He then built electric generators, heaters and coolers using only air as fuel. The breakthrough using machines was Schauberger's claim to have found a way to make his vortex machines auto-rotate at rotational speeds between 10,000 and 20,000 revolutions per minute (8).

In some Schauberger machines, a small high-speed electric engine would spin the air around an axis using a paddle-like propeller. The motor would continue accelerating the rotating air until it reached the critical speed of auto-rotation. At this point, the process was self-sustaining with air being drawn in and expelled with no additional input of energy (9). Air could be drawn in on a continuous basis since it was being cooled and thus made more dense in the vortex spiral. Greater density is loss of volume. Loss of volume created lower pressure at the air inlet with drew in more and more air as the reaction continued. Greater air speed at the point of ejection also served to lower the pressure as explained in Bernoulli's Law (the same process which makes an airplane wing lift the aircraft), thus helping to lowering pressure at the inlet.

So to review: air is drawn in one end of the machine by an electric-powered, paddle-like fan or by spinning the entire machine as was the case with the saucer model. Air is then spiraled into a vortex of special proportion and shape designed by Schauberger. The air is made more dense yet cooled as it funnels down to its smallest diameter. At this point, just before expansive forces take over, energy is liberated perhaps due to the un-gluing of sub-atomic forces which frees energy in some manner currently imperfectly understood. The air begins to expand in a centrifugal motion as it



where centripetal forces ceased and centrifugal forces began, these air particles reversed their spin and altered their rotation.

Further, Coats explains that the neutrons, which were left over in the process described above, and contrary to accepted views, are themselves magnetic (13). These neutrons were expelled from the saucer centrifugally along with water, water vapor and air which had not reacted as stated above. These "magnetic" neutrons, on the outside of the saucer body may serve to increase the diamagnetic reaction of the copper saucer which would be both pushing away from the earth and the cloud of surrounding "magnetically charged" neutrons. In other words, the Schauberger disc may have been repelling away from the magnetically charged atmosphere which it itself had just created.

Dr. Richard LeFors Clark proposes a more detailed description of similar ideas involving the mechanism of the Bloch Wall (14). This will be discussed in the section involving Karl Schappeller but it should be kept in mind while reading these ideas that Dr. Clark had Schauberger in mind. These ideas and others pertaining to both Schauberger and Karl Schappeller will be presented in the Schappeller section to follow.

The history of the Schauberger flying disc models is as follows. According to Alexander's son, Aloys Kokaly, a German, began work for Viktor Schauberger in the early days of the Second World War producing certain parts for a "flying object" which were hard to obtain in Austria. The parts were to be delivered to the Kertl Works in Vienna which was the site of this work at the time. The Kertl Works were operating "on higher authority" in association with Schauberger. Kokaly was received at Kertl by its chief and told by this individual, somewhat bitterly, that one of these strange contraptions had already flown. As a matter of fact it had gone right through the roof of the Kertl plant (15). The year was 1940.

Coats tells us that the purpose of this device was twofold. First, it was to investigate free energy production. This could be done by running a shaft to the rapidly rotating wheel-like component which was auto-rotating at between 10,000 and 20,000rpm. Using reduction gearing, some of that energy could be mechanically coupled to an electric generator producing electricity at no cost. The second purpose of these experiments was to test Schauberger's theories on levitation and flight (16).

Two prototypes were said to have been built at Kertl. The test flight was done without Schauberger's presence or even his permission to do the test. The model flew as described above but it did considerable destruction to the Kertl Works so there were mixed feels concerning the success of this flight. The force of levitation was so strong that it sheared six 1/4 inch diameter high-tensile steel anchor bolts on its way to the roof. Coats reports that according to Schauberger's calculations based upon previous tests, a 20 centimeter diameter device of this sort, with a rotational velocity of 20,000 rpm, would have lifted a weight of 228 tons (17).

A few years earlier in 1934 Schauberger had met with Hitler to discuss alternative energy ideas (18). Nothing came of this meeting immediately but after Germany annexed Austria in 1938, Schauberger became involved in research at Professor Kotschau's laboratory in Nuremberg. Assisted by his son, Walter, who had just completed engineering studies at a technical college in Dresden, Viktor Schauberger went to work with a Dr. Winter on a plan to extract electrical energy directly from a water flow. Some success was achieved. Alexander's son reports that a potential of 50,000 volts was achieved but that no practical results came from this at that time (19).

Probably based upon the fact that Viktor Schauberger was a veteran of the Great War, he was inducted into the Waffen-SS in 1943. This put him under the direct control of SS chief Heinrich Himmler. Schauberger was ordered to castle Schoenbrunn near the Mauthausen concentration camp in Austria. There he was to select qualified prisoners, twenty to thirty craftsmen, technicians and engineers, and begin work on a new, secret weapon. Schauberger arranged improved conditions for his team and produced another flying saucer model (20).

In May, 1945, because of the deteriorating circumstances of the war, Schauberger was re-located to Leonstein in Upper Austria by the SS. There, just after a successful test flight of his latest device, it was seized by an American intelligence unit which appeared to be well informed about it. Schauberger was debriefed by American intelligence, according to Coats, detained, and told not to participate in further research (21).

Coats was actually able to locate a surviving example of a Schauberger saucer model. Excellent photographs of this device are to be found in his book, *Living Energies*, as well as a dissection of it into its various components. It is unclear if this device was one of the earlier (1940) or later (1945) projects.

After the war, Schauberger worked on agricultural projects in Austria until one day in the late 1957 when he was contacted by two Americans. They promised Viktor almost unlimited resources if he and his son Walter would work for them in the United States (22). Discussion concerning the exact source and motives for this offer are beyond the scope of

this discussion but suffice it to say that they were powerful interests. The Schaubergers were sent to Texas, near the Red River, where Viktor was asked to disclose everything he knew and Walter was asked to set Viktor's terminology into the standard language of physics and engineering. This whole episode proved extremely unsatisfactory for both Schaubergers and they returned to Austria after about three months. As a condition for their return, Viktor was asked to sign away his knowledge to this powerful concern. Viktor was given a contract in English, which he did not read. Nevertheless, the deal was done and the Schaubergers returned to Austria (23). Viktor, already in poor health, died five days later on September 25, 1958. Walter continued advancing his father's research in Austria until his death in 1997.

Coats provides us with pictures of one of the Schauberger saucers in question and an explanation of its workings (24). This saucer was composed of a number of copper plates bolted together. Air was drawn in at the top and into the rapidly spinning saucer which was set into motion by an electric motor. In this machine no paddles pushed upon the air to start it. Instead, a motor was used to spin the whole saucer model to the desired number of revolutions per minute. The air was thus spun rapidly over channels formed by the upper and lower surfaces of two copper plates. On these plates alternate ridges and depressions on both plates kept the air moving in snake-like wave forms and it moved toward the periphery of the saucer. Because the saucer was rapidly spinning, the air was folded over upon itself as it moved laterally into many individual vortices. The air was rotating in these vortices and moving up and down between the ridged plates. It was also moving around as the saucer spun on its axis. This is a double-spiral motion which additionally duplicates the undulating motion seen on the Schauberger log flumes. The air was cooled and made more dense as it progressed towards the periphery. At and around the saucer the periphery, it was ejected into the atmosphere at great speed.

In this machine, centripetal air flow changes to centrifugal air flow at this periphery. The air, once outside the saucer, spirals away in a centrifugal motion. It is at this periphery, at the mid line of the saucer, where the change of motion takes place. It is here that energy is liberated. It is this energy which gives the saucer its quality of levitation.

Sometimes the Coanda Effect is cited as a reason this saucer flew (25). Coanda effects, if present at all, are only a secondary force if Viktor Schauberger's calculations are correct. Coanda effects alone could never be powerful enough to generate the lifting force equal to 228 tons which Schauberger estimated his small model produced.

The important factual points to keep in mind are these: First, this saucer-model, probably in more than one version, actually flew. Second, one model still exists today. Therefore this "flying saucer" is a physical reality which can be photographed, touched and studied. Third, explanations of the mysterious energetic forces causing lift in this device should not be forgotten. The German scientific leadership was interested in implosion and in what Schauberger had to teach them but they did not necessarily want to be limited by the use of air to achieve these results. Instead, they may have wanted to use Schauberger ideas but actuating these principles with electronic components. We will see some ideas relating to Schauberger in a future example.

## **The Viktor Schauberger Models**

### **Sources and References**

1. Coats, Callum, 1996, page 276, Living Energies, Gateway Books, Bath, U.K.
2. Coats, Callum, 1996, page 46
3. Coats, Callum, 1996, page 276
4. Coats, Callum, 1996, page 290
5. Freeman, Gordon PhD., 1999, personal correspondence
6. ibid
7. Coats, Callum, 1996, 290
8. Coats, Callum, 1996, 287
9. ibid
10. Coats, Callum, 1996, page 292
11. Coats, Callum, 1996, pages 290-292
12. Coats, Callum, 1996, page 292
13. ibid
14. Clark, Richard LeFors PhD., 1987, "The Earth Grid, Human Levitation And Gravity Anomalies" in Anti-Gravity And The World Grid, edited by David Hatcher Childress, Adventures Unlimited Press, Stelle, Illinois
15. Alexandersson, Olaf, 1990, page 87, Living Water. Gateway Books, The Hollies, Wellow Bath, U.K.
16. Coats, Callum, 1996, page 287



17. ibid
18. Kadmon, date unknown, pages 10, 23, Ahnstern 1, "ViktorSchauberger", Aorta c/o Petak, Postfach 788, A-1011, Wien, Austria
19. Alexandersson, Olaf, 1990, pages 89-91
20. Coats, Callum, 1996, page 11
21. ibid
22. Coats, Callum, 1996, page 15
23. Coats, Callum, 1996, page 27
24. Coats, Callum, 1996, pages 287-293
25. Reba, Imants, 1966, page 86, "Applications Of The Coanda Effect", Scientific American

[Chapter 4 Index](#)

[Main Index](#)

**The KM-2 Rocket**

# Spies Bid for Franco's Weapons

## Agents Ascribe 'Flying Saucers' to New Rocket

By LIONEL SHAPIRO.

**G**ENEVA.—Three German scientists working under the personal sponsorship of Generalissimo Francisco Franco have developed two highly advanced weapons of war, according to specifications and blueprints smuggled out of Spain by the agent of an independent European spy organization.

The first weapon is an electromagnetic rocket which, it is claimed, is responsible for the "flying saucers" seen over the North American continent last summer and for at least one and perhaps two hitherto unexplained accidents to transport aircraft.

The second weapon is an artillery warhead employing the principle of nuclear energy and described as having a startling disintegrating power.

Blueprints of the weapons have been offered for sale to at least three of the great powers. The degree of credence placed in them by the military intelligence sections of these powers is indicated by the fact that two of them—of whom this correspondent has certain knowledge—have made strenuous and, indeed, dramatic efforts to acquire the blueprints.

### Big Sums Offered

The disclosure that these plans were available has touched off the most intense activity among secret agents in European capitals since the end of the war. Huge sums of money and even threats of death have been involved in negotiations.

The nation which coupled a threat of death to its bid is Soviet Russia.

I came upon the story three weeks ago by accidental interception of a document catalog-

ing the weapons. This was being circularized through Europe's intricate network of secret agents. Since then, careful checking among agents and military intelligence organizations in several countries has disclosed:

That the principal powers fully believe Franco has been developing new weapons.

That the weapons (particularly the electro-magnetic rocket) do actually exist and are now being manufactured in Spain.

According to the information available, the weapons were developed in secret laboratories located near Marbella on the south coast of Spain just east of Gibraltar. They were tested in Franco's presence early last summer. The rocket, known as KM2 after its inventors, Professors Knob and Mueller—was tested off Malaga while Franco watched from the deck of his yacht.

The rocket is described as having a range of 16,000 kilometers (9,942 miles) traveling in a given direction. Its flight can be controlled by radio for at least the first 5,000 kilometers (3,107 miles) and when the control is removed the rocket is attracted by electric vibrations of flying planes or the magnetism of the nearest mass of metal. It explodes when it reaches the attracting element.

The agent who smuggled the blueprints out of Spain, and who presumably was present at the tests, claims that the rockets were directed over North America and that they were responsible for at least one and probably two transport-plane accidents which, for want of better explanation, were attributed to structural defects.

The nuclear-energy projectile

is credited to a Professor Halkmann. It is described as twenty-two centimeters (8.7 inches) long and is used as a warhead for artillery shells. The agent claims that Franco is already mass-producing automatic guns to fire these new shells and that the first tests of the projectiles show them to have unprecedented explosive qualities.

Copyright, 1947, North American Newspaper Alliance, Inc.

Post-War German science for Generalissimo Francisco Franco. This is from the Denver Post, November 9, 1947, four months after flying saucers were seen all over the USA.

A shred of evidence comes down to us though the years in the form of a newspaper article by Lionel Shapiro in the Denver Post, dated November 9, 1947, and titled "Spies Bid for Franco's Weapons". (Please refer to a copy of that article). It should be noted that this was a few months after the summer of 1947, the first and largest UFO flap in history, which included the Kenneth Arnold sighting and the flying saucer activity of Roswell. It should also be noted that the Denver Post was nor is not a tabloid publication.

In doing research, this newspaper was contacted in an attempt to learn the whereabouts of the author, Lionel Shapiro. Unlike so many newspapers in the United States which have been purchased and merged by conglomerates, this newspaper is still intact and in existence. Unfortunately, no record could be found of Mr. Shapiro in their personnel files although they did maintain files going back that far. Also, no record could be found in their sister publication, The Rocky

Mountain News. It was suggested that Mr. Shapiro was "a stringer", that is, a writer who did not work directly for the newspaper and whose work was purchased on a piece by piece basis. His work seems to have been channeled through the North American Newspaper Alliance. More of Mr. Shapiro's history and connections will unfold as the tale progresses.

This article describes two devices. The first is an "electromagnetic rocket", sometimes referred to later as the "KM- 2 rocket" in other literature. The second is a nuclear warhead small enough to be fired by an artillery piece. The nuclear warhead which is affixed to a cannon projectile, is novel at this time and is interesting since such devices were built and fired shortly thereafter by the United States military. The article's description of the nuclear cannon is correct. This was a German invention and was under development in Germany during the latter stages of the war. A prototype was even built and it carried the German designation of DKM 44 (1). This very cannon was copied by the Americans and became the T-131 which fired a nuclear warhead (2).

The discussion of the nuclear cannon is really beyond the scope of this book but what is important to bear in mind concerning this discussion is that if fifty percent of this article has proven to be accurate. The nuclear cannon was built and it stemmed from a German prototype. Does this not at least raise the possibility that the other fifty percent is accurate also?

Returning to the electromagnetic rocket itself, this device is right on point for the discussion of field propulsion. Some points are ascertained in reading this article. Its description as a "rocket" would lead one to believe it was cylindrical in shape rather than saucer-shaped. It is suggested that this device was responsible for the flying saucer sightings over the USA that previous summer. This speaks for its operational range. It was said to have been tested off Malaga while Franco watched. The device was constructed in the town of Marbella, east of Gibraltar. Finally, it was said to have been of German origin, even naming the German scientists who built it.

Even Spain itself is of some interest here since this country's ruler, Generalissimo Francisco Franco, was openly sympathetic to the Nazis. The Nazis had assisted Franco militarily in the Spanish Civil War during the 1930s and were instrumental in his retention of power. During the final stages of the Second World War and afterward Spain was seen, by the Germans as a safe haven for all those things they wished to keep out of Allied hands, including secret weapons. Many shipments of gold, secret blueprints, specialty steel, machine tools, scientists and high ranking Nazis were sent to Spain (3). Colonel Otto Skorzeny, head of several SS post-war, self-help organizations even set up his headquarters in Madrid (4). Spain served as a home-away- from-home for the SS after the war.

In analyzing the means by which the KM-2 device flew, it must be noted that gravitational force can be overcome through the use of a strong electrostatic charge as shown by the work of T. Townsend Brown beginning in the 1920s. This is sometimes referred to as the Biefeld-Brown Effect. Imagine a torpedo-shaped model with a dielectric center section suspended by a string from the ceiling. If this model were charged with high voltage, one end would become positive and the other end would become negative. Movement would occur toward the positively charged direction if the voltage was sufficient and the charged ends remained separated by the dielectric (5).

This dielectric is an insulating material which can keep positive and negative charges from interacting with each other and so canceling each other out. They are commonly used in capacitors or condensers which have a positive charge on one side while retaining a negative charge on the other. If the charge can be contained by the non-conducting dielectric, a force is exerted in the direction of the positive side with the application of 75,000 to 300,000 volts. One way to conceive of this action is to imagine a gravity hill whose slope increases with the intensity of the ion charge. The craft being powered simply slides down the gravity gradient like a surfboard on a wave (6).

This concept is a new, non-conventional form of flight. It is non-aerodynamic method of flight. All previous conventional flight had either been through the use of lighter than air balloons, winged craft powered by propellers, jets or rockets or the brute force of rockets themselves. Using this method, Brown advocated defeating gravity by generating another form of energy over which gravity could be surfed. It is a form of field propulsion.

## **Electric Charge And Propulsion**

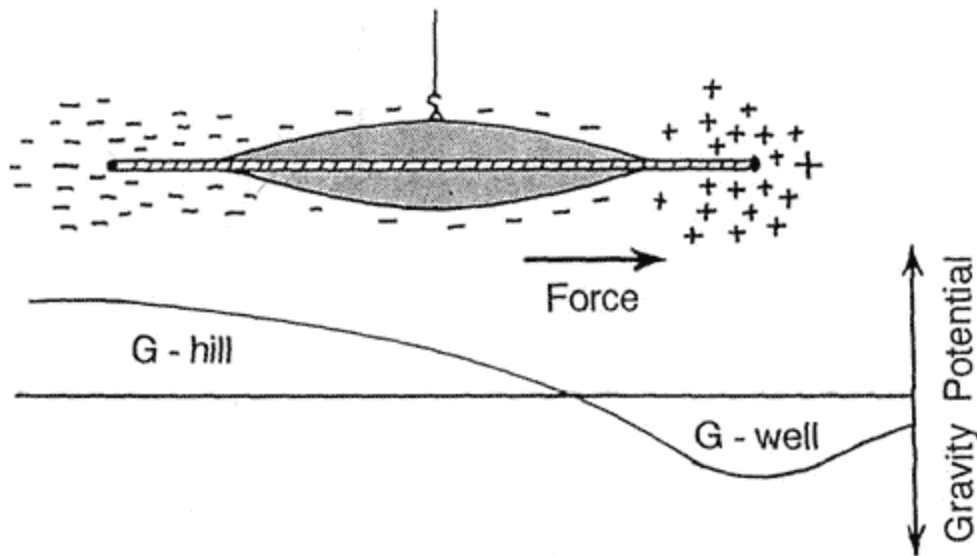
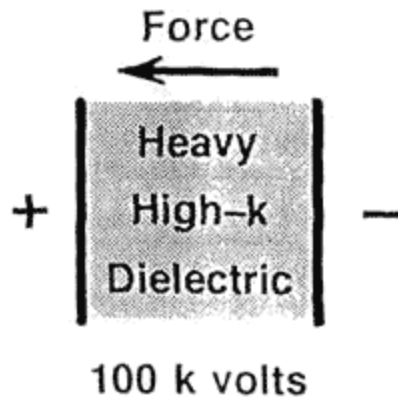

T.T. Brown found that when strong electric charges are separated by a dielectric, movement occurs towards the positive charge as if gravity were reduced on the positive side or as if the charged object were sliding down a hill.

T. Townsend Brown demonstrated this means of propulsion to the American military during the 1950s. He used a saucer-shaped model tethered only by a high voltage line supplying the charge to the model (7). During that decade Brown built increasingly larger, faster models using this method. Brown found that a saucer or a triangle was the best shape for this type of flying craft. A secret proposal, code-named Winterhaven, was to develop a Mach 3 anti gravity saucer interceptor was put forth to the U.S. Air Force (8). This project was further developed through the 1960s but after this all traces of this concept seem to disappear.

But where Brown is overlooked is not only did he have a method of electrostatic propulsion but he also had a self-contained method to impart this charge to a flying craft. He invented a flame-jet generator or electrokinetic generator which supplied the necessary high voltage in a light weight, compact manner (9).

The flame-jet generator utilized a jet engine with an electrified needle mounted in the exhaust nozzle to inject negative ions in the jet's exhaust stream. A corresponding but positive charge is automatically built up upon the leading front edge of the craft. As long as there is no leakage through the dielectric or insulating material, in this case through the wings and body of the craft, propulsive force is generated in proportion to the strength of the charge attained. Brown estimated that such a flame-jet generator could produce potentials as high as 15 million volts of potential (10).

Ionized air molecules on the leading edge of the craft's surface had other positive benefits. The positive electrical field on the wing's leading edge reduced air friction so that drag caused by air molecules was reduced. This was because individual air molecules on the wing's leading edge were repelled from each other by their like charges (11). Frictional heating was reduced. The sonic boom of such a craft was softened (12). And finally, any returning radar signal was

greatly reduced (13). Dr. Paul La Violette has made the argument that all these characteristics are incorporated into the American B-2 bomber, concluding that the B-2 bomber is in reality an anti-gravity aircraft (14).

As Brown repeatedly points out in his Electrokinetic Generator patent, any fluid stream can be substituted for the jet engine's fuel and air (15). This means that hot water vapor or steam itself would be suitable for this purpose.

If T. Townsend Brown had been working on this form of flight since the 1920s, is it not conceivable that others were also? Remember that the KM-2 device is described as an "electromagnetic rocket". If a combination design is considered, one which combines the electrokinetic apparatus with the electrokinetic generator, a picture emerges which would seem to fulfill the description given to the KM-2 "electromagnetic rocket".

The real question may be if the flow of this knowledge went from Brown to the Germans or from the Germans to Brown as was the case with so much high technology in the post-war years. T. T. Brown's early collaborator and mentor was a Dr. Paul Biefeld a Professor of Physics and Astronomy at Dennison University. Dr. Biefeld was a German speaker who was a fellow student of Albert Einstein in Switzerland. Physicists share information across international boundaries. There is no reason for German scientists not to have followed developments in this Biefeld-Brown Effect, as it is sometimes called, for the twenty years leading up to World War Two.

Before leaving the KM-2 discussion, perhaps we should return to the reporter who originally broke this story of the German "Electromagnetic Rocket" in 1947, Lionel Shapiro for a closer look at who he really was. It seems this reporter does have a history of breaking or leaking stories through the North American Newspaper Alliance. These stories which, prior to his involvement, could only be classified as "secret". The point in question is a 1946 report, brought to our attention through the extensive research of Dr. Milos Jesensky and Mr. Robert Lesniakiewicz and translated into English for me by Milos Vnenk. This account of post-wartime intrigue can only be outlined here.

On October 13, 1945, over five months after the hostilities in Europe had ended, the French embassy in Prag notified the Czechoslovakian Foreign Ministry that an SS officer in a French detention camp had given them information that a cache of secret documents existed near Prag. This cache took the form of a tunnel in which 32 boxes of secret documents were hidden and were wired with explosives before being sealed at its opening. The French offered their services and the information given to them by the SS officer in question, Guenther Achenbach. But even after three months of waiting, no response was received by the French from the Czechoslovakian Foreign Ministry (16).

Somehow the Americans got wind of this information. Incredibly, the Americans on February 13, 1946 mounted an armed incursion into Czechoslovakia which was in the Soviet sphere of occupation, retrieved this hoard of information and escaped back into occupied Germany. Naturally the Czechoslovakians were furious and demanded and got an apology from the Americans. They also demanded the return of the German documents stolen from their sovereign territory. The Americans did return documents but probably not those sensitive documents for which the expedition was mounted (17).

Dr. Jesensky and Mr. Lesniakiewicz have made an extensive study of the German technical facilities surrounding Prag and the purposes for these facilities. It is their conclusion that the sensitive technical information recovered and which prompted this dangerous action was nothing other than plans of the German disc airplane, the "V-7" (18).

### **The KM-2 Rocket -- Mystery Solved**

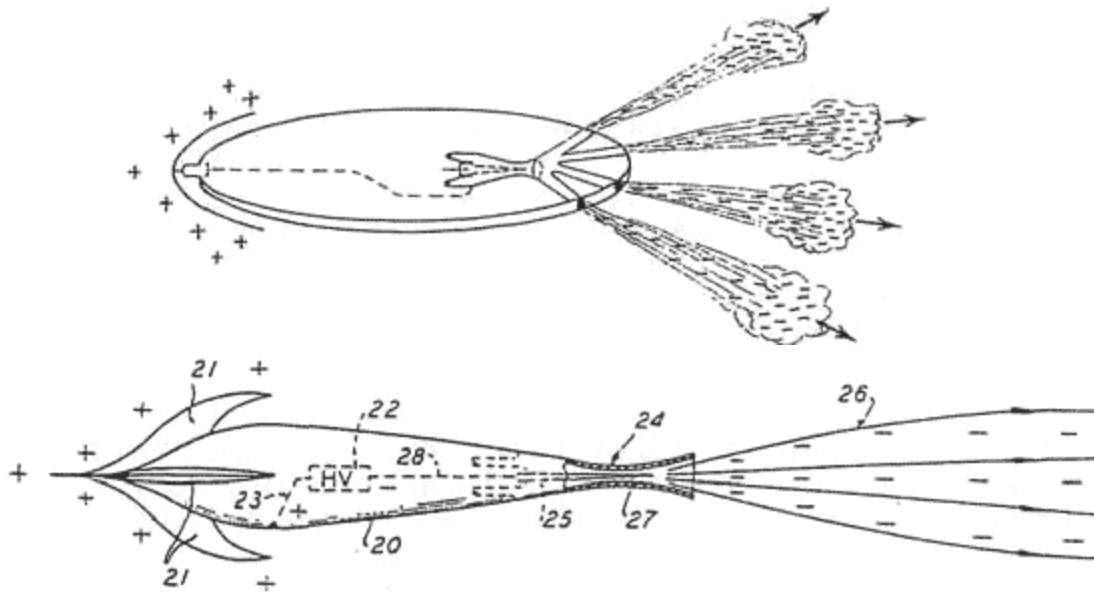
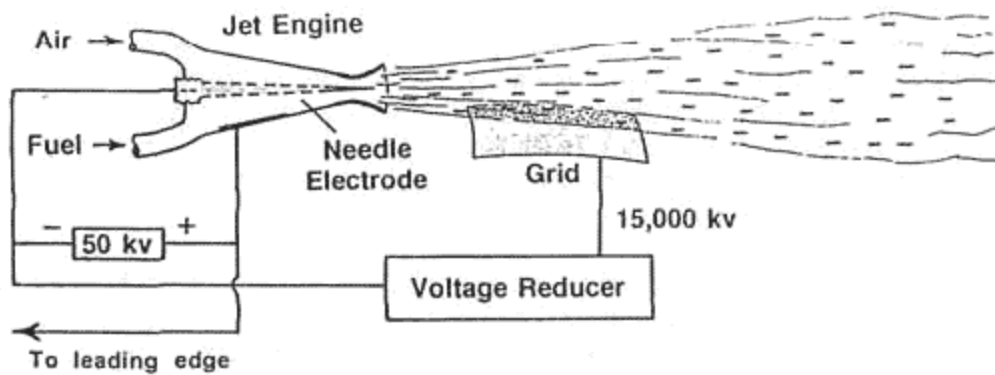

Top: T.T. Brown's flame-jet generator, capable of supplying millions of volts. Middle: Brown's saucer design which is definitely food for thought. Bottom: Brown's electric rocket incorporating flame-jet generator. The KM-2 rocket must have been a very similar device.

It was Lionel Shapiro, writing under the name Lionel S. B. Shapiro who broke this story for the North American Newspaper Alliance (19).

As confirmation, it can be added that the story was also covered by Ms. Lux Taub in the Swedish publication "Expressen" with stories on 2/19/46, 2/22/46 and 2/24/46 (20).

In the immediate post-war world there seems to have been a relaxation on the release German technical information. Not the detailed analytic work done by the various Allied intelligence teams combing the carcass of the dead Reich, but the popular reporting by Shapiro and others who received the "o.k." to publish brief stories recounting Nazi technology which would be squelched later as the cold war got underway.

But even given this relaxation, what are the chances of one reporter stumbling upon both the stories of the electromagnetic rocket and the U.S. incursion into Czechoslovakia, first, and on his own? It is also noteworthy that both of these stories dealt with the topic of this book, or at least one which is related to that theme. Mr. Shapiro must have been a very well connected reporter indeed! He is also an excellent source of information.

A point of speculation should be made concerning the KM-2 device. As stated above, T. T. Brown believed that water vapor or steam was a suitable medium for his electrokinetic generator. Water vapor is present in the atmosphere, as we all know. A small atomic engine, such as was mentioned earlier in connection with the Messerschmitt P-1073, burning and being cooled by atmospheric gasses, might provide enough water vapor to enable the electrokinetic generator to produce

the high voltage required. This would be an atomic powered field propulsion device. Further, Friedrich Georg gives us details on an atomic steam engine with the Germans were designing to power a propeller driven aircraft (21). An easy substitution of a device similar to the Brown electrokinetic generator for the propellers could have been made enabling a device with all the characteristics given for the KM-2 electromagnetic rocket to have been born. And of course Dr. Giuseppe Belluzzo would have been waiting and willing to do the plumbing.

## The KM-2 Rocket

### Sources and References

1. Georg, Friedrich, 2000, pages 171-173
2. ibid
3. Infield, Glenn B., 1981, pages 179, 192, Skorzeny Hitler's Commando, St. Martin's Press, New York >
4. Infield, Glenn B., 1981, pages 173, 183
5. LaViolette, Paul A. Ph.D., 1993, pages 84-85, "The U.S. Antigravity Squadron" in Electrogravitics Systems Reports On A New Propulsion Methodology edited by Thomas Valone, M.A., P.E., 1994, Integrity Research Institute, Washington D.C.
6. ibid
7. ibid
8. LaViolette, Paul A. Ph.D., 1993, page 87
9. U.S. Patent Number 3,022,430, Granted: 2/20/62 to T.T. Brown, titled "Electrokinetic Generator"
10. ibid
11. LaViolette, Paul A. Ph.D., 1993, page 93
12. LaViolette, Paul A. Ph.D., 1993, page 87
13. LaViolette, Paul A. Ph.D., 1993, page 88
14. LaViolette, Paul A. Ph.D., 1993
15. U.S. Patent Number 3,022,430, Granted: 2/20/62 to T.T. Brown, titled "Electrokinetic Generator"
16. Jesensky, Milos Ph.D., and Robert Lesniakiewicz, 1998, pages 98-102, "Wunderland" Memozemske Technologie Treiti Rise. Aos Publishing
17. Jesensky, Milos Ph.D. and Robert Lesniakiewicz, 1998, page 100
18. Jesensky, Milos Ph.D. and Robert Lesniakiewicz, 1998, page 102
19. Jesensky, Milos Ph.D. and Robert Lesniakiewicz, 1998, page 100
20. Jesensky, Milos Ph.D. and Robert Lesniakiewicz, 1998, page 101
21. Georg, Friedrich, 2000, pages 87-89, Hitlers Siegeswaffen Band 1: Luftwaffe Und Marine Geheime Nuklearwaffen des Dritten Reiches und ihre Trägersysteme. Amun Verlag, Heinrich-Jung Verlagsgesellschaft mbH.

### [Chapter Index](#)

### [Main Index](#)

## Field Propulsion Saucers

The existence of World War Two German field propulsion flying saucers is a topic which is denied by virtually every reputable authority in aviation history. It is also denied by many researchers studying German saucers. The problem is that in the years immediately following the Second World War the earth's skies suddenly began to be populated by flying craft which did some remarkable things. They flew at unheard of speeds. They made very sharp turns, seemingly non-aerodynamic turns, even at this extreme speed. They lacked the glowing tail of jets or rockets but they glowed or gave off light at night from their periphery or from the whole craft. They were silent or almost silent. Sometimes they gave off sounds that an electric generator or motor might make. Sometimes vehicles with electrically based ignition systems ceased to operate in the presence of these saucers. No government claimed these flying craft, yet they were seen all over the world.

The press and popular culture attributed these unusual craft to an extraterrestrial source. Yet, after over fifty years, no real proof for this assertion has ever come forth. Let's come back down to earth. By all accounts these saucer were solid and material in nature. Perhaps it is time to attribute their origin into a solid, material source.

It seems only proper to begin searching for an explanation for field propulsion saucers with the very sources which we now know built conventional flying saucers, the Germans of the Third Reich. The earliest reference to a field propulsion saucer being a German invention is from a 1960 book by Michael X in which it is described as a "flying egg" (1). Michael X., under the name Michael X. Barton, is also the author who, in 1968, wrote The German Saucer Story. In the second book returns to the theme again (2). This time he cites a source. His primary informant, Hermann Klaas, describes twelve secret weapons to Barton. They are:

1. The flying disc
2. A tank made entirely of one piece of metal
3. The sound wave weapon
4. A laser beam weapon
5. A flaming artificial cloud
6. A robot bomb
7. A charged cloud weapon
8. An armor piercing projectile
9. The electromagnetic KM-2 rocket
10. A paralyzing ray
11. Electronic ball lighting
12. The flying bottle, tube, sphere, etc.

Thirty-two years later we certainly know that some of these weapons did exist. It has been confirmed that the Germans were working on weapons numbered 1, 2, 3, 6, and 8 for instance. It has been confirmed that the Germans were working on x-ray or gamma ray weapons as well as another type, possible laser weapons. It has been confirmed that the Germans were working on a gaseous cloud as a means of combating enemy bombers. So in view of this track record, his claim of research on a "flying bottle" should be given serious consideration.

But what is the specific evidence which would cause us to believe that the Germans were working on a field propulsion saucer? As one paws through the literature on German saucers, some evidence is encountered which could indicate field propulsion vehicles. There are the still pictures which will be discussed later on. Here, we will focus on just three pieces of evidence, that of an eyewitness, a German pilot, who saw such things on the ground, a Combined Intelligence Objectives Sub-Committee report and an

F.B.I. report. The F.B.I. report was taken years after the war but for reasons which will be discussed, there is reason to conclude this report has merit.

### **German Eye Witnesses**

The first report comes to us courtesy of researcher Horst Schuppmann. A friend of Mr. Schuppmann's interviewed an eyewitness to German saucers during the Second World War. This report first appeared in the 1998 Geheimtechnologien. Wunderwaffen Und Irdischen Facetten Des UFO-Phaenomens by Karl-Heinz Zunneck (3).

The subject of this interview was a German pilot who flew many missions in a JU-52, taking off and touching down in rough, presumably outlying airfields. The Junkers JU-52 was an aircraft used by the Luftwaffe for many roles and could be described as a mainstay or a workhorse. It was a transport airplane, a troop carrier and even had been used as a bomber. It resembled and was used in a similar way to the American Douglas Dakota or DC-3. The main difference between the two aircraft was that the JU-52 had three engines as opposed to the Dakota's two and the JU-52 lacked a traditional airframe, instead deriving structural strength from a unique corrugated metal shell, which also made the appearance of the JU-52 distinctive.

The sighting in question was reported to the author, Mr. Zunneck, by Horst Schuppmann whose friend knew the pilot of the JU-52 in question. The date was July, 1944. Accompanying the pilot on this three and one-half hour flight was a co-pilot, a mechanic, and the radio man. The airplane took off from Brest-Deblin and flew on a westerly course to Lublin. The flight was unfolding smoothly which was somewhat abnormal for the particular time and stage of the war. Over Stettin Lagoon preparations were made to land. A large white cross was sighted which was the marker for their goal, a meadow landing strip. The aircraft descended, landed normally and rolled toward a group of bushes which would hide the aircraft from view.



Then things took a decided turn to the abnormal. Harsh orders were received that the pilot, co-pilot and mechanic were not to exit the airplane. Suddenly, the radio man had vanished. The others waited an hour in vain for his return. Finally, the pilot decided to get out of the airplane and find his missing crewman, without orders, and on his own.

On the airfield itself nobody was to be seen. There was only one building visible which was a lonely hanger. The pilot, ever concerned with maintaining cover, headed straight for this hanger. Upon arrival he opened a narrow, high sliding door and entered, hoping to receive some information. No person was to be seen but what the pilot did see bewildered him so that the image was deeply ingrained in his mind.

There in the hanger stood three or four very large, round, dark dish shaped metal constructions on telescope-like leg stands. The objects were about 6 meters off the ground and the objects themselves were 12 to 15 meters in diameter. The pilot compared the shape of the objects to a giant soup dish or soup plate.

Suddenly, out of the half darkness a military guard emerged. The guard let the pilot know that he was in an area which was strictly off limits. In fact, the pilot was told, on no uncertain terms, to disappear immediately or this would be his last day on earth.

This day had started as a routine flight connecting two outlying airfields. This pilot had no expectations of seeing something so unusual that he barely had context in which to place it. Further, even as his mind was transfixed and in a process of trying to give understanding to what he was seeing, he was suddenly jolted out of this tableau by a guard threatening his very life and ordering him to leave.

Of course the question of what those objects in the hanger really were comes back to this pilot even after almost 55 years. The pilot personally attributes it to the so called "Magnetscheibe", literally, "magnet-disk". According to the pilot rumors of these objects circulated in pilot circles since the summer of 1944 (4).

Two things can definitely be said of this sighting. First, it can be said is that this sighting seems to be of the smaller type of German field propulsion saucer as opposed to a larger version. Second, these saucers can definitely be ascribed to belonging to and in the possession of German military forces during the Second World War. At no time in this report has the word "alien" or "extraterrestrial" ever been mentioned or even considered.

Beyond that it can be said that the pilot personally believed these to be of the "Magnetscheibe" type, that is to say not powered by chemical combustion. There reasons to believe this is correct. These saucers were found on a remote and rather primitive airfield. They were in the only building present. This means that they did not need an extensive support system.

The chemically powered jet or rocket engines needed an extensive field support structure. They needed to be refueled after every flight. The two liquid fuels used by the Me-163 rocket-fighter, for instance, ignited immediately when they came into contact with each other with explosive intensity. The fuel tanks had to be washed out after each flight and separate ground crews were responsible for each type of liquid fuel. It is noteworthy that no such support ground support structure or personnel was in evidence on this occasion. All that was observed was a large structure filled with saucers and a guard. The ground support necessary for launch of these craft must have been minimal and argues for the field propulsion hypothesis.

Of course the weakness in this report is the lack of the name of the pilot. Even if this report is taken at a minimal level of credulity, it constitutes a rumor of German involvement with field propulsion vehicles.

The reader will recall that the research paradigm being followed is that once mention was made by a German source of a particular thing, then (and only then) corroborating information should be sought from U.S. governmental agencies using FOIA.

### **A Combined Intelligence Objectives Sub-Committee Report**

Since we have a German claiming field propulsion saucers we can now follow our research paradigm and search governmental records for corroboration. The Combined Intelligence Objectives Sub-Committee reports are a series of reports compiled by agents of the United States and Great Britain. Most were written immediately after the field work was done. The agents targeted specific things such as sites, people, specific technology or other aspects of specific interest. The agents then wrote a summary report which is what is entered into the record.

As with almost all summary reports at this level, the implications of what is being described are lacking. These reports do not set the particular technology into any context. That is, these reports do not say how a specific technology under study was to be applied in the future in some, if not most, cases. Behind these reports must be a body of information and at least a few individuals intimately familiar with the technology in question. They were familiar with the technology and the context to which it was useful. If another government operative was interested in that topic or its implications, and if his security clearance sufficed, he would be shown the underlying material and presumably be directed to the particular individual who was its residing expert.

Only slowly, if at all, was this secret science leaked or given to American industry and then only with an appropriate cover-story, one which may even supply a pseudo-inventor of that technology. This is conspiracy at its finest. This deception is beyond the scope of this book but what is important for us now is that sometimes a mistake or slip-up was made in writing or censoring these reports and hints of things of stupendous technological worth actually surfaces. Such is the case with Combined Intelligence Objectives Sub-Committee Report number 146 regarding Dr. Georg Otto Erb and his work which is reproduced here.

**Combined Intelligence Objectives Sub-Committee Report #46 Dr. Georg Otto Erb**

~~CONFIDENTIAL~~  
DR. OTTO ERB  
Waffenamt 5000, Berlin  
(Target No. G1/659, 201/288)

Erb with his two assistants, Georg Buhler and Ulrich Lewitz are available at the above address and are known to the Gov Detachment at BORKEN.

To be investigated as early as possible. Suggest C.S.A.F. and C.R.A.D. (Fuzes) will be interested.

This man was interviewed by two members of the staff of D.D.O.S., and the attached report is compiled from their notes and a statement by Dr. ERB.

Dr. ERB was born in 1912. He is a doctor of Physics. At the outbreak of war he opened a small laboratory and had made a few inventions. In 1940 he was called up, but after a few weeks was released for research work and returned to Berlin to work for Physikalisches Reichsanstalt. At this time he worked on acoustic heads for torpedoes. In 1941 he was again working in his own laboratory - mainly on fuzes. He was arrested in Berlin by the Gestapo in Nov 1944 on a charge of "favouering the enemy and sabotage". Buhler was also jailed. They escaped on 22 Apr 45 as the Russians were advancing into Berlin.

It is felt that he is reliable and likely to be of value as a source of information about the lines on which German development was proceeding in the field of experiment in which he was concerned.

#### Statement of the work of Dr. Otto ERB

1. Before the war, Dr. Erb developed measuring instruments of all sorts. The following are examples of his work:

- (i) Measuring apparatus for interference free determination of the hardness and tempor of steel.
- (ii) Electrical measuring apparatus for automatic control of storage temperature.
- (iii) Apparatus for conversion of residual heat into electrical energy.
- (iv) Electrical medical apparatus of various sorts.
- (v) High tension apparatus.
- (vi) Warning mechanisms for excessive temperatures.
- (vii) Electric fire fighting apparatus.
- (viii) Electric sources of energy of various kinds.
- (ix) Apparatus for turning the energy of the sun's rays into electrical energy.
- (x) Rearward impulse propulsion for vohs and aircraft.
- (xi) Wood gas generator for high performance.

After outbreak of war he had to devote his research to armament work.

~~CONFIDENTIAL~~  
CIC 75/139

- 1 -

Enclosure

Dr. Erb was on the cutting edge of several technologies according to this report. None of these technologies was especially exciting in 1946, however. Jets, rockets and atomic energy were the hot-ticket items of the time. Nobody cared about new sources of electrical energy. The USA had plenty of electricity and plenty of oil to generate more. It was also known by then that atomic power could be applied to generate even more electricity. Nobody cared about Dr. Erb's experiments listed under item (iii) "Apparatus for conversion of residual heat into electrical energy" or item (viii) "Electrical sources of energy of various kinds" or even item (ix) "Apparatus for turning the energy of the sun's rays into electrical energy". Since nobody cared about these things, there was really no reason not to list them in the summary report. Their significance would only be realized a generation later during the "energy crisis" of the mid-1970s and by then it was too late to censor the report. One can only wonder where this research would have led if it funding had continued over the next thirty years. Or did it continue in secret?

Of course by now many readers will have already read number and grasped the significance of number (x) "Rearward impulse propulsion for vehs and aircraft". Given the nature of Dr. Erb's other work, it is a safe bet that this "impulse propulsion" was not of the jet or rocket nature. In fact there remains little doubt that this propulsion was, in fact, field propulsion. Dr.Erb was experimenting on means to apply forward motion using rearward impulse propulsion to aircraft and "vehs" (vehicles). If this is not the smoking gun for German experiments in field propulsion saucers, it is at least a hint that there is a gun.

### **The Smoking Gun: An F.B.I. Report**

That is right, Fox Mulder was not the first F.B.I. agent to believe in UFOs. The files in question are F.B.I. file numbers 62-83894-383, 62-838994-384 and 62-83894-385. Their date is 11/7/57 to 11/8/57. They deal with a Polish immigrant, then living in the United States, who reported his wartime experience to the Bureau hoping it might throw some light on UFO sightings seen in Texas at about this time.

### **F.B.I. Reports On A German Field Propulsion Saucer F.B.I. Reports On A German Field Propulsion Saucer**

FBI

Date: 11/7/57

Mr. Tolson	_____
Mr. Boardman	_____
Mr. Belmont	_____
Mr. Mohr	_____
Mr. Nease	_____
Mr. Parsons	_____
Mr. Rosen	_____
Mr. Tamm	_____
Mr. Trotter	_____
Mr. Clayton	_____
Tele. Room	_____
Mr. Holloman	_____
Miss Gandy	_____

Transmit the following message via AIRTEL

AISU - id.  
(Priority or Method of Mailing)

TO: DIRECTOR, FBI 7/4/57, Summary

FROM: SAC, DETROIT (100-28505)

UNIDENTIFIED FLYING OBJECTS; IS - X.

Re Detroit Teletype to Bureau, 11/7/57, captioned "UNIDENTIFIED FLYING OBJECTS; IS - X."

Interview of [redacted], aka. [redacted], reported in blank memo, five copies of which are herewith for the Bureau, was conducted by SA [redacted]

No indication of irrational or otherwise abnormal behavior by [redacted] was observed during the interview.

[redacted] advised that his communication was directed to Mr. Arthur CUYLER rather than to President EISENHOWER after seeing Mr. CUYLER's picture and identification with the President's Office in a local paper.

[redacted] resides with his wife, nee [redacted], married in 1952 at Detroit, and four small children, in a [redacted] residence in an old Polish neighborhood at [redacted] Detroit. No previous record located in Detroit indices identifiable with [redacted] or his wife.

On 11/7/57, [redacted] advised IC [redacted] that records of the [redacted], reflect only [redacted] inquiries concerning [redacted] during 6/56 and 3/57 and 6/57, which confirm his local address and employment.

3 - Bureau (Encs. 5) (EL)  
1 - Detroit

En: JLE  
(4)

ENCLOSURE

**AIRTEL**

INDEXED-16  
RECORDED-18

100-28505-357

21 NOV 8 1957

76 NOV 25 1957

Approved: \_\_\_\_\_  
Special Agent in Charge

Sent \_\_\_\_\_ M Per \_\_\_\_\_

*Saffers*

*etc. by Army*



UNITED STATES DEPARTMENT OF JUSTICE

FEDERAL BUREAU OF INVESTIGATION

Detroit 31, Michigan

NOVEMBER 7, 1957

In Reply, Please Refer to  
File No.

UNIDENTIFIED FLYING OBJECTS

In response to a letter directed by him to Mr. Robert Cutler, Special Assistant to President Dwight D. Eisenhower, reflecting that he "might have some information about the rocket in Texas," [REDACTED] Detroit, was interviewed November 7, 1957, and furnished the following information:

Born February 19, 1926 in the State of Warsaw, Poland, [REDACTED] was brought from Poland as a prisoner of war to Gut Alt Golssen, approximately 30 miles east of Berlin, Germany, in May, 1942, where he remained until a few weeks after the end of World War II. He spent the following years at Displaced Persons Camps at Wark, Strasburg, Offenburg, Milheim and Freiburg, Germany. He attended a radio technician school at Freiburg and for about a year was employed in a textile mill at Laurachbaben, Germany. He arrived in the United States at New York, May 2, 1951, via the "S.S. General Stewart" as a displaced person, destined to the Reverend [REDACTED] Lamtranck, Michigan; his alien registration number -

Since May, 1951, he has been employed at the Gobel Brewery, Detroit.

News report of mysterious vehicle in Texas causing engines to stall prompted him to communicate with the United States Government concerning a similar phenomenon observed by him in 1944 in the area of Gut Alt Golssen.

According to [REDACTED], during 1944, month not recalled, while enroute to work in a field a short distance north of Gut Alt Golssen, their tractor engine stalled on a road through a swamp area. No machinery or other vehicle was then visible although a noise was heard described as a high-pitched whine similar to that produced by a large electric generator.

62-83594-284

An "SS" guard appeared and talked briefly with the German driver of the tractor, who waited five to ten minutes, after which the noise stopped and the tractor engine was started normally. Approximately 3 hours later in the same swamp area, but away from the road where the work crew was cutting "hay", he surreptitiously, because of the German in charge of the crew and "SS" guards in the otherwise deserted area, observed a circular enclosure approximately 100 to 150 yards in diameter protected from viewers by a tarpaulin-type wall approximately 50 feet high, from which a vehicle was observed to slowly rise vertically to a height sufficient to clear the wall and then to move slowly horizontally a short distance out of his view, which was obstructed by nearby trees.

This vehicle, observed from approximately 500 feet, was described as circular in shape, 75 to 100 yards in diameter, and about 14 feet high, consisting of dark gray stationary top and bottom sections, five to six feet high. The approximate three foot middle section appeared to be a rapidly moving component producing a continuous blur similar to an aeroplane propeller, but extending the circumference of the vehicle so far as could be observed. The noise emanating from the vehicle was similar but of somewhat lower pitch than the noise previously heard. The engine of the tractor again stalled on this occasion and no effort was made by the German driver to start the engine until the noise stopped, after which the engine started normally.

Uninsulated metal, possibly copper, cables one and one-half inch to two inches in diameter, on and under the surface of the ground, in some places covered by water, were observed on this and previous occasions, apparently running between the enclosure and a small concrete column-like structure between the road and enclosure.

This area was not visited by [redacted] again until shortly after the end of World War II, when it was observed the cables had been removed and the previous locations of the concrete structure and the enclosure were covered by water. [redacted] stated he has not been in communication since 1945 with any of the work crew of 16 or 18 men, consisting of Russian, French and Polish POWs, who had discussed this incident among themselves many times. However, of these, [redacted] was able to recall by name only [redacted] no address known, described as [redacted] then about 50 years of age and presumed by [redacted] to have returned to Poland after 1945.

R. SPENCER

74

Mr. J. Patrick Coyne

You will be advised of any further information which may be received regarding [redacted] and the information furnished by him.

b7c,d  
1

Pursuant to your request, [redacted] letter is returned herewith.

Sincerely yours,

Edgar Hoover

Enclosure  
*pk*

- 1 - Office of Security  
Department of State
- 1 - Director  
Central Intelligence Agency  
Attention: Deputy Director, Plans
- 1 - Assistant Chief of Staff, Intelligence  
Department of the Army  
Attention: Chief, Security Division
- 1 - Director of Naval Intelligence
- 1 - Office of Special Investigations  
Air Force
- 1 - Immigration and Naturalization Service



FEDERAL BUREAU OF INVESTIGATION  
U. S. DEPARTMENT OF JUSTICE  
COMMUNICATIONS SECTION

NOV 7 1957

TELETYPE

URGENT 11-7-57 4-55 PM EST WHH

TO DIRECTOR FBI

FROM SAC, DETROIT 1P

UNIDENTIFIED FLYING OBJECTS, IS - X. REBUTEL NOV SIX LAST.

[REDACTED]

WARSAW, POLAND, WAS GERMAN POW

MAY, NINETEEN FORTY TWO, UNTIL SUMMER OF NINETEEN FORTYFIVE.

ARRIVED NY MAY TWO, NINETEEN FIFTYONE, AS DP, AR NO. [REDACTED]

[REDACTED] UPON INTERVIEW

ADVISED THAT WHILE GERMAN POW DURING NINETEEN FORTYFOUR OBSERVED

A VEHICLE DESCRIBED AS CIRCULAR IN SHAPE, SEVENTY FIVE TO ONE

HUNDRED YARDS IN DIAMETER, APPROXIMATELY FOURTEEN FEET HIGH. THE

VEHICLE WAS OBSERVED TO SLOWLY RISE VERTICALLY TO HEIGHT

SUFFICIENT TO CLEAR FIFTY FOOT WALL AND TO MOVE SLOWLY

HORIZONTALLY A SHORT DISTANCE OUT OF VIEW OBSTRUCTED BY TREES.

ENGINE OF TRACTOR FAILED TO OPERATE DURING THIS PERIOD AND

ON ONE OTHER OCCASION WHEN HIGH PITCHED WHINNING NOISE HEARD

IN AREA. NO INDICATION OF MENTAL INSTABILITY DURING

INTERVIEW. FURTHER DETAILS FOLLOW AMSD.

~~RECORDED LINE FOUR WORD WX FOUR SHLD BE TWO~~

END AND A K PLS

11 4-58 PM OK FBI WA EW

TU DIC

*ekreniga*

RECORDED-84  
INDEXED-84

62-53394-343

Mr. Belmont

NOV 13 1957

EX 163

- Mr. Tolson \_\_\_\_\_
- Mr. Boardman \_\_\_\_\_
- Mr. Belmont \_\_\_\_\_
- Mr. Mohr \_\_\_\_\_
- Mr. Nease \_\_\_\_\_
- Mr. Parsons \_\_\_\_\_
- Mr. Rosen \_\_\_\_\_
- Mr. Tamm \_\_\_\_\_
- Mr. Trotter \_\_\_\_\_
- Mr. Clayton \_\_\_\_\_
- Tele. Room \_\_\_\_\_
- Mr. Holloman \_\_\_\_\_
- Miss Gandy \_\_\_\_\_

*telephonically advised 11/8/57 WOB*

*b7c*

*b7c*

1 - Mr. [redacted]  
1 - Mr. Belmont  
1 - Mr. [redacted]  
1 - Liaison

b7c

BY COURIER SERVICE  
November 8, 1957

Mr. J. Patrick Coyne  
National Security Council  
Executive Office Building  
Washington 25, D. C.

ALL INFORMATION CONTAINED  
HEREIN IS UNCLASSIFIED  
DATE 5/20/85 BY [redacted]  
COMP # 045974

RECORDED-84  
INDEXED-84

62-3894-383  
Dear Pat:

Reference is made to the letter addressed to "Mr. Robert Cutler, Washington 25, D. C.," by Mr. [redacted] Detroit 11, Michigan, in which [redacted] advised that he might have some information "about the rocket in Texas." He desired to know to whom he could speak in this regard.

b7c  
b7c,d

EX 105

Mr. [redacted] was interviewed on November 7, 1957, at which time he advised that his name is [redacted] that he is also known as [redacted] that he was born on February 19, 1926, in Warsaw, Poland, and that he was a German prisoner of war from May, 1942, until the Summer of 1945. [redacted] advised that he arrived in New York on May 2, 1951, as a displaced person, Alien Registration. He advised that during 1944, while he was a German prisoner of war, he observed a vehicle described as circular in shape, seventy-five to one hundred yards in diameter, and approximately fourteen feet high. He stated the vehicle was observed to rise vertically to a height sufficient to clear a fifty-foot wall and that it moved slowly horizontally a short distance out of view which was obstructed by trees. He stated that the engine of a tractor failed to operate during this period and that the engine fell on one other occasion when a high-pitched whining noise was heard in the area. During the interview, [redacted] spoke in a rational manner with no indication of mental instability.

NOV 8 5 13 PM '57  
REC'D [redacted]

son \_\_\_\_\_  
hole \_\_\_\_\_  
rdman \_\_\_\_\_  
mont \_\_\_\_\_  
r \_\_\_\_\_  
sons \_\_\_\_\_  
er \_\_\_\_\_  
am \_\_\_\_\_  
tter \_\_\_\_\_  
ise \_\_\_\_\_  
e. Room \_\_\_\_\_  
loman \_\_\_\_\_  
dy \_\_\_\_\_

ESS:dmm  
(13)

BY COURIER SVC  
6 8 NOV 21 1957  
3 NOV 12  
COMM - FBI

Mr. J. Patrick Coyne

You will be advised of any further information which may be received regarding [REDACTED] and the information furnished by him.

b7c,d  
|

Pursuant to your request, [REDACTED] letter is returned herewith.

Sincerely yours,

Edgar Hoover

Enclosure  
*pk*

- 1 - Office of Security  
Department of State
- 1 - Director  
Central Intelligence Agency  
Attention: Deputy Director, Plans
- 1 - Assistant Chief of Staff, Intelligence  
Department of the Army  
Attention: Chief, Security Division
- 1 - Director of Naval Intelligence
- 1 - Office of Special Investigations  
Air Force
- 1 - Immigration and Naturalization Service

- 2 -

The time of the sighting was in 1944, the place was Gut Alt Golssen, approximately 30 miles east of Berlin. The informant, whose name has been deleted, states that while he was a prisoner of war working for the Germans, a flying object arose nearby from behind an enclosure hidden from view by a 50 foot high tarpaulin-type wall. It rose about 500 feet then moved away horizontally. The only noise the object made was a high-pitched whine. The object was described as being 75 to 100 feet in diameter and 14 feet high. It was composed of a dark gray stationary top and bottom sections five to six feet high with a rapidly moving center section producing only a blur and extending the circumference of the vehicle. Notably, the engine of their farm tractor stalled during this event and the SS guards told the driver not to attempt a restart until the whine could no longer be heard.

Because of what I believe is their importance, these files have been reproduced here in their entirety. One of the most compelling reasons for taking this report so seriously is that the government of the United States of America took this report so seriously. It is hard to believe that an agency such as the

F.B.I. would take and retain reports of flying saucers which had no special meaning for them. Add to this the fact that this report was over ten years old at the time it was taken and that it concerns a report originating in another country.

The F.B.I. operates within the USA and usually does not concern itself with foreign matters unless they have meaning for the internal security of the United States. Could the reason that this report was taken and retained for so many years be that it did, in fact, have meaning for the internal security of the United States? Did it have something to do with the flying saucers seen over Texas at the time which also stopped motor vehicles?

As an alternative to the security issues, could there have been another reason that the F.B.I. was so interested in flying saucers? Did the F.B.I. desperately want information on UFOs which was held by the military and other branches of the intelligence community which was not shared with the F.B.I.? It has been rumored that J. Edgar Hoover, head of the F.B.I. at the time, was very interested in learning these secrets but was held "out of the loop". It could be that the F.B.I. was already aware of German saucers through security clearances done on German scientists coming to the USA under Operation Paperclip? The ego of J. Edgar Hoover may have been a factor in the Bureau's quest to learn more on this subject. Hoover may have wanted to be on an equal footing with other intelligence chiefs.

For whatever reason, something in these reports resonated with the F.B.I. The report was taken seriously, investigated and kept. This fact alone speaks volumes for the existence of UFOs in general and German saucers in particular.

### **Discussion of German Field Propulsion Saucers**

Some explanation has been attempted regarding the Schauberger models and the KM-2 rocket. From this point on, the discussion of German field propulsion saucers will move away from the areas

centering around observed evidence and into areas of interpretation. Some of the German flying craft described are flying saucers in the classic sense. The F.B.I. report describes something which moves by non-aerodynamic means and which remains the source of speculation.

At this point, mention should be made of the ideas of some prominent writers in this field. The first of these is Mr. **William Lyne** of Lamy, New Mexico. Mr. Lyne has written two books concerning German saucers and field propulsion, [Pentagon Aliens](#) and *Occult Ether Physics*. His ideas on the mechanisms of field propulsion remain the best thought out and the most detailed on the subject.

Mr. Lyne lives near the secret weapons testing facilities of Los Alamos and White Sands. These were the places where German weaponry was brought for testing after the war and where the United States tested its first atomic bomb. It is still an area of secret military research and secret military projects. Then as now, aspects of atomic energy figure in this setting. It is also an area which attracted much flying saucer activity in the late 1940s and 1950s. Mr. Lyne was a child during this period of time and personally witnessed flying saucers as did his family and friends. Later, as an adult, he went about trying to explain mechanisms for the type of flight he had witnessed.

Lyne worked within certain parameters. He rejected the alien hypothesis outright. He realized that flying saucers had to have been made by humans. Since he observed the saucers in the 1940s and 1950s, he knew that any explanation of their workings must be limited to the technology present in the 1940s or earlier. He connected UFO technology to other recently imported technology from Germany while believing both had their origins with [Nikola Tesla](#) (5).

Further, there is no mention of intangibles by Mr. Lyne. There are no unknown energies or mystical forces at work. Mr. Lyne stands with both feet on the ground. Things are concrete. Machinery is diagrammed. Matter and energy function as they always have. In reading Mr. Lyne's work one can almost smell the machine oil and the ozone.

Mr. Lyne builds upon the work of Nikola Tesla who developed his unique ideas over many years of experimentation and invention. This basis built upon real world experimentation, testing and application separates Tesla's ether theory ideas from those which will be explored later. Mr. Lyne presents us with an ether theory in which ether is super-fine matter which exists everywhere. It is so fine that it will go through the holes left in ordinary matter (6).

A few words about Mr. Lyne's ideas are necessary to set a context for this discussion. Just as an internal combustion engine can be described as a "heat pump" so can the flying saucer drive of Mr. Lyne be described as an "ether pump". Ether (very fine matter) is attracted to the saucer via an electric field, then pumped through the saucer and out again using the principle of magneto-hydro-dynamic pumping (7). This magneto-hydro-dynamic pumping is related to the Hall Effect. Edwin Hall placed a gold leaf strip in which an electric current was flowing into a gap in a magnetic field. An electromotive force was produced at right angles to the magnetic field and the electric current. This electromotive force was proportional to the product of the electric current and the magnetic field (8).

According to experimentation by Tesla, ether is made rigid with high voltage, high frequency electrical energy (9). The convex shape of the upper half of the saucer projects the electrical attractive force, generated by a specific electronic component, in an ever expanding arch over the saucer. Ether is made rigid and anchors the saucer. This is possible since the total mass of the ether caught in the electric field is far greater than the mass of the saucer. Near the surface of the saucer, the "rigified" ether is pulled into the saucer in what Mr. Lyne calls "tubes of force". These tubes of force would be pulled right through the opposite side of the saucer and out if it were not for the blocking force of a second apparatus which nullifies the tubes of force and prevents this from happening. This imbalance is the reason the saucer is able to move (10).

The electrical components necessary for this to take place are, according to Mr. Lyne, a Tesla turbine to supply electrical power and two types of Tesla pancake coils (11).

The Tesla turbine is a wheel-like device which is described in Mr. Lyne's book (12) and elsewhere (13). Mr. Lyne orients this turbine vertically in his drawings but oriented with its flat spinning surface horizontally, this might, perhaps, account for the spinning disc witnessed on some saucers.

The Tesla pancake coils are also described in both sources cited. Mr. Lyne goes further and gives instructions as to their manufacture. One type of pancake coil insures forth a negative discharge of DC energy, tuned to a one-fourth wave length, and is oriented in the desired direction of flight (14). The other type of pancake coil is mounted exactly opposite the first and emits a positive AC discharge which is used to dissolve the ether flow or tubes of force.

Dr. Gordon Freeman, a Fucannelli-like scientist who knows about such matters, has been curious about the abbreviated wave-cycle of the first pancake coil. His position is that one must not only understand conventional scientific theory in order to understand the way a field propulsion saucer flies but one must also understand some concepts which are sometimes labeled "occult". Dr. Freeman has worked out a "common denominator" for some field propulsion vehicles the essence of which he has shared (15). Dr. Freeman's ability to analyze, explain and interrelate physics, engineering and "occult" geometry is only matched by his ability to explain it all on a level we can all understand.

### **Tesla, Vril And Coler Devices**

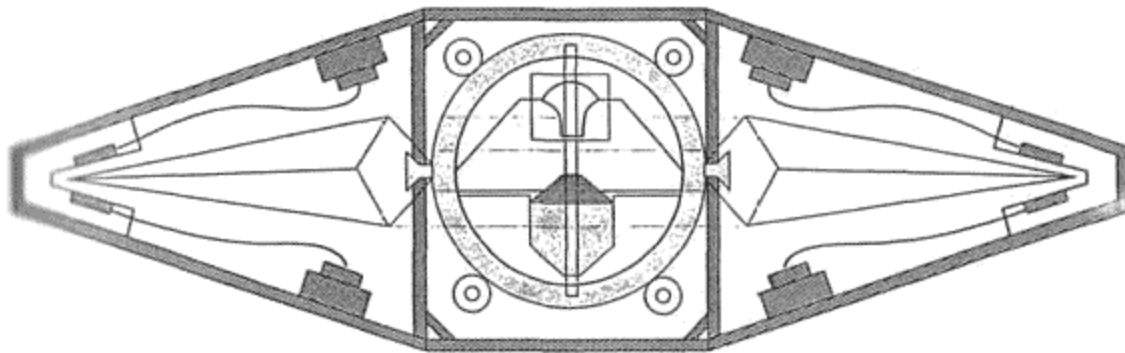
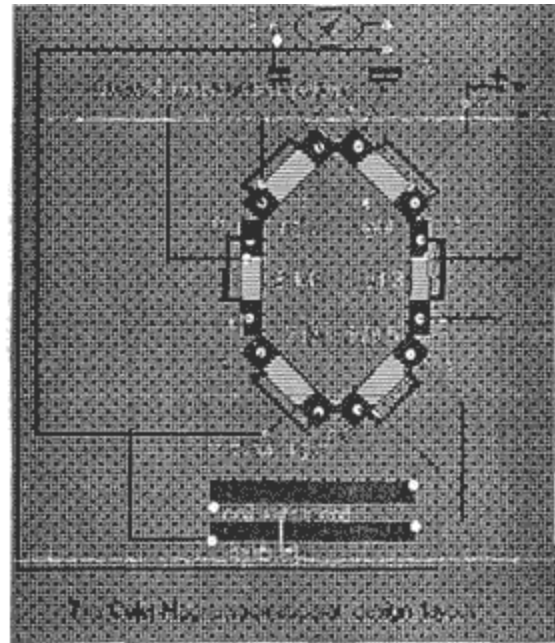
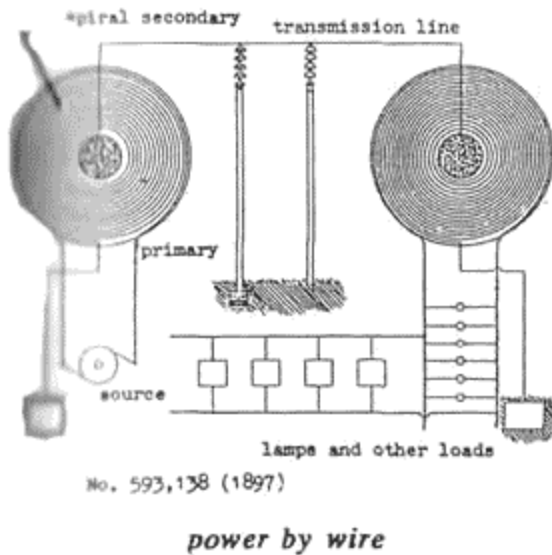

Top Left: Pancake Tesla coil with the secondary coil inside the primary. Top Right: The smaller of the Hans Coler free-energy machines. Bottom: Cut away showing Vril power plant. Was this related to the Schappeller device?

Some individuals see hidden, esoteric or occult knowledge as the inspiration for the breakthroughs the Germans made in field propulsion flying vehicles. Usually coupled with an exotic-theory of UFO origin, it is an equally exotic local from which this exotic theory is said to have originated. We have been presented with this line of reasoning for years in the "UFOs are of extraterrestrial origin" theory. Indeed, some writers see an extraterrestrial origin for German UFOs also as we shall see. But just stating that UFOs are of occult or alien origin is not an explanation in itself. It still begs the question of how they operate. Their method of operation, their technology, must be explained regardless of where they came from in order for the explanation to be a satisfying one.

Returning to earth, another theory is that the German scientists were influenced by some ideas originating in Asia. Tibet and India are the suspects in question. UFOs have been reported over Mongolia, Tibet and India for centuries. The ancient Indian seven claimed to have constructed aircraft which resemble flying saucers. These saucers are called Vimanas. Ancient Indian texts in Sanskrit speak of the flight and manufacture of these saucers. The German "Ahnenerbe", an organization whose purpose is associated with researching Germanic ancestry, sent out expeditions to the East with the express purpose of acquiring ancient, hidden knowledge. This is precisely what Heinrich Haarer was doing, whose book served as the basis for the film "Seven Years in Tibet". This link between flying saucers of the East and the West is suspected as an influence on German field propulsion vehicles (16). The exact connection, though, has never been demonstrated.

A connection which is more certain involves Viktor Schauberger's use of Pythagorean geometry. There is no doubt that Schauberger incorporated this mathematics into his work but what is intriguing is what is said about this body of mathematical knowledge. The story goes that it was the Knights Templar who stumbled upon this knowledge in the Holy

Land during the Crusades and it was they who kept and incorporated this knowledge through the use of "sacred geometry".

Both the above mentioned schools of thought lead far beyond the parameters of this book but the reader should be aware of what is said about them and their relationship to German flying discs.

Whether it is called "occult technology" or "conventional technology", in the end, it is just simply technology. And in the end, as Dr. Freeman says, "all machines can be reduced to numbers". What is called by some "occult" might be better called "arcane". This is because this technology, which seems to be the basis of field propulsion, is taught only to certain individuals, technological initiates, who use and need this knowledge for their work on government sponsored black projects. These scientist utilize a technology and understanding which are reserved for their use alone. This knowledge is not taught and not made available to the rest of us. We, the great unwashed masses, are given Einstein and the Theory of Relativity and told that this is the pinnacle of learning. As with all secret information, this arcane knowledge is held on a "need to know" basis. Our government believes that we simply don't need to know. It takes a true genius like Dr. Freeman to recognize this knowledge and set it before us in language that we can understand. It is hoped that Dr. Freeman will publish a book sooner rather than later.

Mention of the "occult" brings us to another line of evidence concerning field propulsion, that put forth by Norbert Juergen-Ratthofer and Ralf Ettl. Mr. Ettl became involved while doing research for a film project on Dr. Wernher von Braun. A film company was paying for this research. A package or several packages of information were obtained by the production company which had more to do with UFOs than rocketry. This information was laid aside by Mr. Ettl but he returned to it after enlisting the help of Norbert Juergen-Ratthofer who had a special interest in that subject (17).

The packages contained breathtakingly clear photographs of German saucers in flight. Some of these pictures may be just models but some look authentic and are posed against a landscape. Nowadays, pictures can be generated via computer and these pictures surfaced within modern times. At least one negative from these pictures which was given to Mr. Vladimir Terziski by Mr. Juergen-Ratthofer and seen by this writer, so at least not all of these pictures were computer generated. The pictures have been seen in public and through video film presentation, for about ten years. To the best of my knowledge these pictures have never been debunked using modern technical photo-analysis. Therefore, they have never been shown to be anything less than legitimate. Until they are shown to be less than legitimate, we must accept them as they are represented to us.

Besides the pictures, these writers provide an entire historical and cultural context for these saucers within the Third Reich, This contest involves secret organizations within the SS. Further, the context provided by these writers involving the occult, channeling, and extraterrestrials. This is the weak point of their presentation since the case for these latter connections is really not strong enough to be "in evidence".

Besides the books of Mr. Ettl and Mr. Juergen-Ratthofer, several other German language writers contribute books on a similar or related theme. The more notable are D.H. Haarmann (18) and O. Bergmann (19). Mr. Ettl and Mr. Juergen-Ratthofer themselves have written several books which are all in German language and available through their publisher (20). Mr. Ettl and Mr. Juergen-Ratthofer have also done two video films, "UFOs Das Dritte Reich Schlaege Zurueck?" and a second film, whose English title is "UFO Secrets of the 3rd Reich". This second film is very well done and contains the pictures mentioned earlier. These films should be seen by anyone seriously interested in German field propulsion saucers (21) (22).

## **Haunebu 2 Test Flight**



Ghostly image of a saucer, said to be a Haunebu 2, on a test flight. Photograph originally from collection of Norbert-Juergen Ratthofer, courtesy of Vladimir Terziski

Mr. Juergen-Ratthofer, Mr. Ettl and allied writers offer two different systems for field propulsion. The smaller saucer-type, which they designate "Vril" was powered by three moving magnetic fields (23). The larger type, designated "Haunebu" was powered by a series of devices according to these writers. In this arrangement, the output of smaller of the Hans Coler "free energy" devices (24), the "Magnetapparat", was used to supply input for the larger Coler device, the "Stromerzeuger". The output of this second device was used to turn a Van de Graaf generator. This energy was directed into something called a Marconi ball dynamo with supplied lift to the saucer (25)(26).

All that seems to have been said about the latter device is that it is mentioned in the same sentence with special saucer condensers developed by T.T. Brown and Professor Paul Biefeld in the nineteen twenties and that "such" ("solche") with a rotor system was done by Professor Marconi, in Italy, in the nineteen thirties. Mr. Juergen-Ratthofer goes on to say that this device is to be considered, in principle, a forerunner to the Searl system (27).

The Haunebu pictures strongly resemble the Adamski saucer pictures of the early 1950s. These saucers were seen and pictures of them taken world-wide. There were many different sources for both sighting of Adamski saucers and pictures of them. There were so many in the early 1950s that it is hard to believe that all of them are fakes. Mr. Ettl and Mr. Juergen-Ratthofer maintain that these "Adamski saucers" are really the German-designed Haunebu type saucers (28). Since they were flown after the war, certain questions as to their origin arise. These questions will be treated in an upcoming section of this book.



Besides the Vril and Haunebu designs mention is made by Mr. Juergen-Ratthofer of another type of field propulsion vehicle. This saucer uses a chemical engine to drive a field propulsion generator (29). The type of chemical engine involved is similar to the famous Walter (Walther) engine, which were to be installed on some types of German submarines.

The Walter process involved a closed circuit system activated by the thermal energy produced by the decomposition of a high concentration of hydrogen peroxide. This reaction occurred in the presence of a catalyst, potassium permanganate, in a decomposition chamber. This resulted in a 600 to 700 degree gas composed of steam and oxygen, under natural pressure sufficient to drive a turbine. After the gas had done its work it was fed into a reclamation chamber which recycled at least part of the gas back into the engine. Additional fuel, Juergen-Ratthofer mentions methanol, could be fed into the system for more heat. The system without additional fuel is called the "cold" system while with added fuel it is called the "hot" system. In fact, the cold system was used on the V-2 rocket to drive the turbo-fuel pumps since known pumps could not handle the volume of liquid necessary to feed this new type of rocket.

### Hybrid Saucer Design



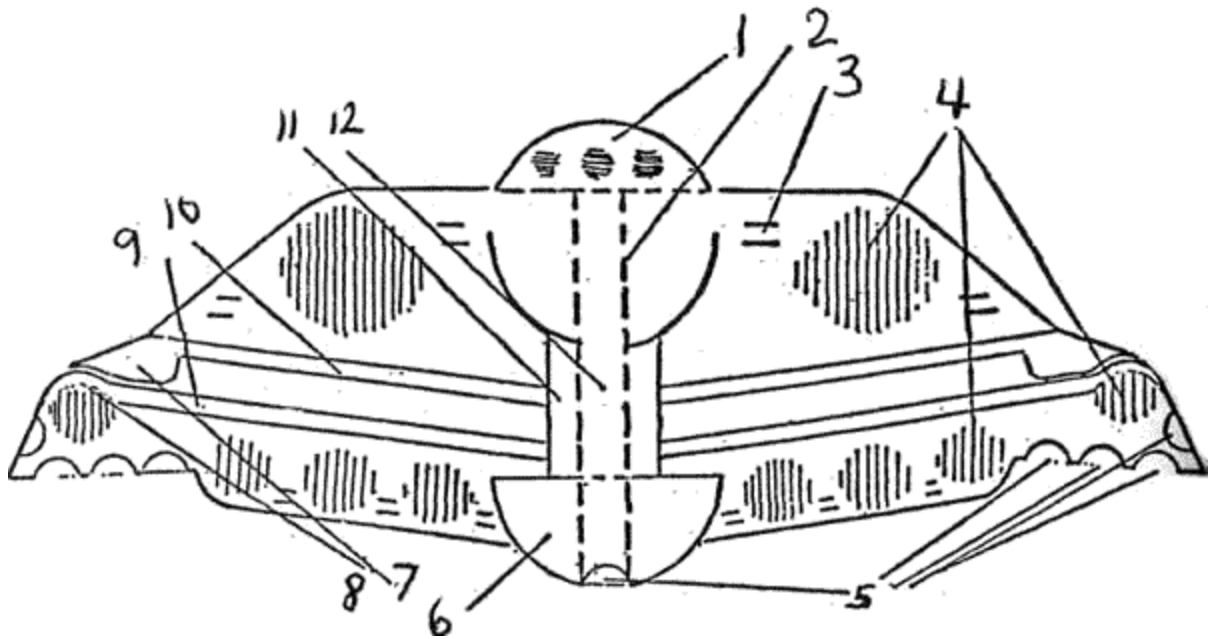

### Chemical/Field Propulsion Saucer (N. Juergen-Ratthofer).

1. Plexiglass pilot's cabin.
2. Crew rooms.
3. Intake air slots (hermetically sealed in space).
4. Vacuum ring retainers with high-performance vacuum pumps.
5. Lifting and steering jets connected to the Walter turbine system.
6. Walter turbines and electric generators with connected machine maintenance rooms.
7. Disc rotor wheel, rotating clockwise.
8. Electromagnet outer ring rotating counter-clockwise.
9. Disc wheel, inner part of the electromagnet outer ring.
10. Segmented disc-rotor and wing screw with adjustable flight blades.
11. Axis of saucer with (a) two electric motors to drive the counter rotating disc motors: electro-gravitation plant, (b) various electrical connections, (c) fuel and water tanks.
12. Connection shaft between pilot's cabin and machine room.

In the hybrid saucer Mr. Juergen-Ratthofer describes, the cold system drives a rotor-stator arrangement which doubles as a blade lifting wing similar to that of a helicopter. The rotor-stator-blade is internally housed in the cowling of the saucer. The output of the rotor-stator is a strong magnetic field which presumably frees the saucer of the constraints of gravity as claimed for the other field propulsion saucers (30). In addition, spaces within the saucer have all air removed by special vacuum pumps with increase the buoyancy of the craft within the atmosphere. Further, some of the hot oxygen-steam mixture is jetted out at the periphery of the saucer while being mixed with methanol for additional heat and therefore thrust. Again, we are reminded of Dr. Belluzzo. We are also reminded of Vesco since he hints at a similar engine (31) which he even vaguely links with "electromagnetic waves" (32). Have we come full-circle?

In the same vane, would be negligent not to mention that anatomic engine might easily be substituted for the Walter engine. The atomic engine might be one of three types. It might be the type which burned the atmosphere itself. This burning would produce hot air and steam from the water contained in the atmosphere. It might be one which produced steam using water carried in tanks. It might be one which super-heats and ejects a gas such as hydrogen or helium. Any of these mediums could be ejected through the rotor blades yielding the desired result. A device of this type would tie together many of the German saucers-plans so far discussed.

Dr. Freeman points out that Marconi "stole" Tesla's inventions. Tesla also built a power-plant of spherical construction which contained vacuum tubes and so may have been superior to the device of Schappeller which we shall look at next. Surprisingly, some detail exists about this Tesla free energy device (33). Tesla used his engine to successfully power a Pierce Arrow automobile. This means that a spherical, working field propulsion device existed in the USA powering, not a flying saucer but an automobile. Dr. Freeman warns not to be confused by many spherical devices, all of which seem different. The fact is that they all work on the same principles (34).

## German Field Propulsion Flying Saucers Sources and References

1. X, Michael, 1960, pages 17, 33, We Want You Is Hitler Alive?, Futura Press, reprinted 1969 by Saucerian Books, Clarksburg, WV.
2. Barton, Michael X., 1968, pages 26-36, The German Saucer Story, Futura Press, Los Angeles
3. Zunneck, Karl-Heinz, 1998, pages 120-122, Geheimtechnologien. Wunderwaffen Und Irdischen Facetten Des UFO-Phaenomens 50 Jahre Desinformaton und die Folaen. CTT-Verlag, Suhl
4. Zunneck, Karl-Heinz, 1998, page 122
5. Lyne, William R., 1999, page 48, [Pentagon Aliens](#). Creatopia Productions, Lamy, New Mexico 87540
6. Lyne, William R., 1999, page 28
7. Lyne, Willaim R., 1999, page 38
8. Lyne, William R., 1999, page 21
9. Lyne, William R., 1999, pages 20, 41
10. Lyne, William R., 1999, page 42
11. Lyne, William R., 1999, pages 197-200
12. ibid
13. Trinkaus, George, 1988, pages 3-4, Tesla The Lost Inventions. High Voltage Press, Portland, OR.
14. Lyne, William R., 1999, page 215
15. Freeman, Gordon Dr., 3/18/01, personal letter to author
16. Stoll, Axel Ph.D., 2001, pages 15-20, Hochtechnologie im Dritten Reich Reichsdeutsche Entwicklungen und die vermutlich wahre Herkunft der "UFOs". Amun-Verlag, Schleusesiedlung 2, D-98553 Schleusingen
17. Ettl, Ralf, 1999, page 11, "Notes To The Vrill-Project" Ursprung und Quellen
18. Haarmann, D.H., 1983, Geheime Wunderwaffen II Geheime Wunderwaffen. III Geheime Wunderwaffen, Hugin Gesellschaft Fuer Politisch-Philosophische Studien E.V., Postfach 23, D- 48472, Hoerstel 3, Germany
19. Bergmann, O., 1988 and 1989, 1 Deutsche Flugscheiben und U- Boote Ueberwachen Die Weltmeere. 11 Deutsche Flugscheiben und U-Boote Ueberwachen Die Weltmeere, Hugin Gesellschaft Fuer Politisch-Philosophische Studien E.V., Postfach 23, D-484772, Hoerstel 3, Germany
20. Dr. Michael Daemboeck Verlag, Markt 86, A-3321 Ardaggr, Austria
21. Video Film "UFOs Das Dritte Reich Schlaegt Zurueck?," available through Dr. Michael Daemboeck Verlag, see reference (18)
22. Video Film "UFO Secrets of the 3rd Reich" available through Total Solutions International, Las Vegas, NV.
23. van Helsing, Jan, 1993, page 129, Geheim Gesellschaften und ihre Macht im 20. Jahrhundert, Ewertverlag, Meppen, Germany
24. British Intelligence Objectives Sub-Committee Final Report No. 1043 Item No. 31, "The Invention Of Hans Coler, Relating To An Alleged New Source Of Power"
25. Video Film "UFOs Das Dritte Reich Schlaegt Zurueck?," available through Dr. Michael Daemboeck Verlag, see reference (18)
26. Juergen-Ratthofer, Norbert and Ralf Ettl, 1992, page 51, Das Vrill-Projekt. Dr. Michael Daemboeck Verlag, Ardaggr, Austria
27. Juergen-Ratthofer, Norbert, date unknown, page 16, "Geheime UFO, 1. Folge: Flugscheibenprojekte aus verschiedenen Staatender Erde", this article was courtesy of Theo Paymans, Holland
28. Juergen-Ratthofer, Norbert, date unknown, pages 84,85, Flugscheiben und andere deutsche und japanische Geheim- und Wunderwaffen im Zweiten Weltkrieg, self-published, available through reference (18)
29. Juergen-Ratthofer, Norbert, date unknown, pages 1 and 16, "Geheime UFO, 2. Folge So baut man fliegende Untertassen und so funktionieren sie", this article was courtesy of Theo Paymans, Holland
30. ibid
31. Vesco, Renato, 1976, pages 163 and 164, Intercept UFO. Pinnacle Books, New York
32. Vesco, Renato, 1976, pages 135-136
33. Nieper, Hans A., 1985, pages 188-189, Conversion of Gravity Field Energy Revolution in Technology, Medicine and Society, MIT Verlag, Oldenburg
34. Freeman, Gordon Dr., 3/18/01, personal letter

## [Chapter 4 Index](#)

### [Main Index](#)

## Atomic Saucers Again?

It is possible that all of the options for the field propulsion of German flying discs have not been presented or had a fair hearing. Two of these other possibilities are reviewed below. The first is the possibility that a world-shattering breakthrough in field propulsion occurred during the Third Reich involving atomic energy. This is plausible given the extensive and mostly still-secret atomic research done by the Germans coupled with the government's attempt to down play UFO sightings immediately following the war. The second possibility is that a field propulsion device was developed out of the early work of the Austrian inventor, Karl Schappeller. This possibility is strengthened by the fact that individuals and organizations involved in this research openly acknowledged that one of their aims was to build an "ether ship".

The German conventional saucer program culminating with atomic propulsion has been discussed. Evidence of German field propulsion saucers has been reviewed. We already know that each step in the conventional German saucer program was a logical development of the previous saucer design. The question is: did the power utilized in the German field propulsion saucers arise from nuclear power? Was there a breakthrough which has been kept secret for almost sixty years?

We have discussed the link between nuclear facilities and flying saucers. Is this evidence, in itself, that an association exists? The association could be for one of two reasons. First, these areas may simply have been the most secure facilities available. The two projects may not have been connected at all. For security reasons, both projects were simply run out of the same area.

The second possibility is that the two projects were run out of the same facility because they are connected somehow. If there is a connection between nuclear energy and field propulsion, what type of connection is this? The connection under discussion is a direct conversion from nuclear energy to field energy. This connection is on the order of the connection between electricity and magnetism or heat and electricity or nuclear energy and heat. Does such a connection exist?

The answer I got from everyone asked was a resounding "no". The consensus seemed to be that the closest we could come to this was to convert nuclear energy to heat energy and then to electrical energy through the medium of a steam turbine. This is how nuclear power plants and atomic submarines work. This method seemed to have nothing to do with flight since the hardware involved is much too bulky and heavy.

We have already reviewed some other options for nuclear powered saucers. Klaus-Peter Rothkugel suggests that the atmosphere itself could be burnt using liquid air as a fuel and a nuclear reactor as a heat source. Friedrich Georg has documented some aircraft engine designs, apparently left on the drawing board, involving a propeller engine driven by steam heated by nuclear power. We have seen the enigmatic Messerschmitt design involving a small nuclear engine on a high-speed aircraft. We have also discussed the atomic rocket approach which involves heating and ejecting of liquid hydrogen using a nuclear reactor in the Lenticular Reentry Vehicle.

While there is no known direct connection between nuclear energy and field propulsion, Dr. Gordon Freeman has made me aware of an alternate method of production of electrical energy through the use of nuclear decay. This is important because with enough electrical energy both electrostatic and electromagnetic field propulsion are possible. Let me relate to you what Dr. Freeman told me as to how this process works. It is amazingly simple.

The simplest method involves the use of two solar cells which are the same size. A piece of paper, the thickness of a business card is cut to the same size as the solar cells. Radium chloride is painted onto both sides of the paper. The paper is then fitted between the solar cells. The radium chloride emits alpha and beta particles which activate the solar cell. The reader might ask, if this method works, why has it not been patented? The answer is, that in a slightly more efficient configuration, it has been patented (1).

There are other forms of this simple example. Imagine a simple circuit used for purposes of generating electromagnetic waves. This circuit would consist of a wire connecting a capacitor and then to a coil. An electrical input is given to this circuit whereby the capacitor is sufficiently charged in order for it to discharge. The electrical energy is carried by the wire to the coil where it is charged. Electrical energy is then carried back from the coil to the capacitor by another wire completing the circuit. Alternately, the capacitor (electrical field) and the coil (magnetic field) are charged and discharged.

The output of this circuit are electromagnetic waves, such as fill the electromagnetic spectrum. The system works until electrical resistance in the three components converts enough electrical energy into heat to sufficiently degrade its output.

What is done using the new atomic decay system is to paint the capacitors with radium chloride. This unstable compound emits alpha and beta particles when magnetically or electro statically pulsed. These particles are absorbed by the capacitors (as well as the other components), the end result of which is an increase in electrical energy in the circuit. If enough capacitors can be wired into the circuit in series to produce enough energy to offset the ohmic degradation, then the output can be maintained for a long time. Radium chloride has a half-life of 800 years.

Of course, if an extra capacitor were wired in to the circuit, an excess of energy would result. Even if this excess energy is small, it can be very important. Devices using a similar method have also been patented (2) (3).

In the next step, the circuit described above is given an antenna and a Tesla coil. The radium chloride doped capacitors are turned to one of the resonant frequencies for the Tesla coil. An antenna is used which is suitable for receiving this same frequency output. A feed back loop is set up whereby energy is being pulsed into the system in these resonant frequencies. It is estimated that an output of three thousand watts can be obtained from this "lifetime battery" with an input of only fifty watts (4). A transformer and other devices can be used to tailor the electrical output produced by this device according to the need. Details for construction and tuning of this "battery" are available commercially (4).

This whole device can be held in one's hand. Imagine the power of one hundred or one thousand such units. Certainly a U-boat or a field propulsion saucer could be powered using this system.

Dr. Freeman believes this nuclear doping might be the missing link in several free energy devices. Dr. Freeman has evidence that both the Hubbard and Hendershot generators were doped with nuclear material. He has evidence that Hubbard actually worked for the Radium Company of America. Further, he has found evidence that it was radioactive material which was used to dope Moray's germanium valve (5).

Even further, he has suggested that the initial starting energy necessary for the operation of the Schappeller device, which will be discussed shortly, was supplied by a radioactively dope delectret (5). Bolstering Dr. Freeman's claim is a U.S. patent using such a radioactive electret to maintain its charge (6). This is not the approach favored in this book, but the use of something like the "lifetime battery" to start the Schappeller device is not beyond the realm of reason. In fact, there is some evidence that a very strange battery was being produced in wartime Germany.

During the war years, at least until 1943, none other than Professor. W. O. Schumann was engaged in building something called a "battery" at the Technical Institute at Munich. This battery was a project to itself and funded by the Deutschen Forschungsgemeinschaft, forerunner of the Reichsforschungsrates, the Reich Research Council (7). The Reich Research Council coordinated high-priority war research between academic, industrial and military facilities.

This is the same Dr. Schumann who was brought to the United States after the war as part of Project Paperclip (8). This is also the same Dr. Schumann noted for the discovery of the Schumann Resonance. Dr. Schumann was no stranger to free energy devices since it was he who evaluated a working Hans Coler device in 1926 and could find no fault, hoax or bad faith, on the part of its inventor (9).

Rumor has it that Dr. Schumann's specialty was antennas and that he was responsible for building or improving American submarine communication after the war. It is said this was done by employing extra low frequency radio equipment and mile-long antennae which were towed behind the submarines themselves. The radio waves employed for this communication were said to go directly through the earth's center. Dr. Schumann also discovered something called the Schumann Resonance which deals with the resonant frequency of the planet earth itself.

Returning to wartime Munich, why would a full professor and world-class scientist be devoting years of research and government sponsorship to a battery while Germany was in the middle of a war? The answer is that this battery was something special. Was this similar to the "lifetime battery"? Could this type of energy production have been the promised means of freeing Germany from dependence of foreign oil? Was this battery an energy producing device, capable of powering or starting a field propulsion saucer?

The old problem arises. The question is not could this be the way it was done. The question is was this the way it was done, What proof is there that nuclear decay was used by the Germans to produce energy by any other means than is in practice today? Dr. Freeman provides one hint.

This scrap of evidence involves a religious sect. It is the Methernita Society of Switzerland. This is a self-contained, Christian brotherhood who own large areas of land in Switzerland. Among their accomplishments is a free energy device they call the Testatika. One desk top machine can yield an output of 3000 watts. This machine or machines have been in existence since the late 1970s and have been demonstrated for outsiders, including scientists and engineers. No fraud has ever been detected.

High voltage is produced by electrostatic means using a Wimhurst generator as in integral part of the Testatika device. The counter-rotating wheels of the Wimhurst generator are not allowed to spin freely, but are purposefully restricted to lower revolutions per minute. Capacitors are used to hold the electric charge which is generated. Dr. Freeman believes that these capacitors are doped with radium chloride. The electric field of the capacitors increases the output of alpha and beta particles derived from the radium chloride. This electron flow is absorbed by the capacitors and other components and fed back into the system.

The Methernita Society has never been forthcoming concerning the workings of this device. The machine itself seems to be the brainchild of one person, Paul Baumann, who is described as Methernita Testatika with Doped Capacitors

Der Testatika-Generator Der erste wissenschaftliche Konverter zur Umwandlung elektrostatischer Energie in elektrodynamische Energie "technician". Even in the old films of the Testatika, Mr. Baumann does not look like a young man. Germany is Switzerland's neighbor and what better place to utilize secret wartime technology than in a closed religious order. Dr. Freeman informs me that one of the builder's assistants talks of radioactive and non-radioactive forces in conjunction with this machine. Dr. Freeman has put these scraps of evidence together and made a drawing which is reproduced here.

**Grundprinzip:**  
Wimhurst-Maschine mit  
2 gegenläufigen Scheiben

**Treibstoff:** Radiumchlorid

**Hauptspeicher:** Elektrosta-  
tische Wimhurst-Kapazität

**Leyden-Speicher:** DC-Spei-  
cher mit 2 Farad für 300 Vdc

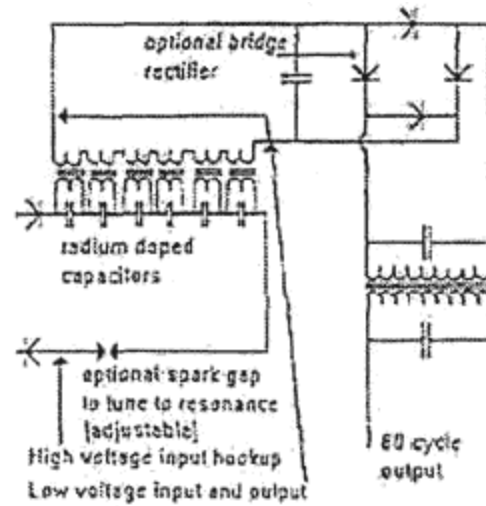

**Drehzahl:** 50 oder 60 U/sec

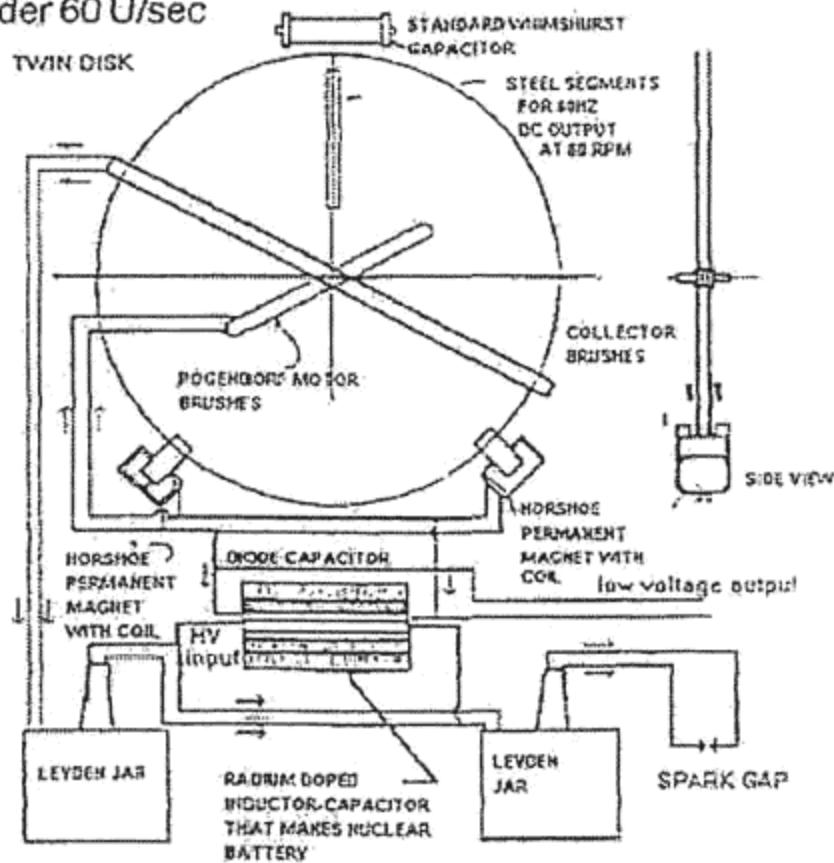

**Dr. Freeman's drawing of the Testatika.**

Let's try reversing an equation. What if the T. T. Brown relationship between a highly charged capacitor, gravity and movement were altered? What if the highly charged capacitor were fixed and unable to move in a gravitational field? Would not the energy evidenced in the movement of the capacitor in T.T. Brown's work be translated into electrical energy and contained in this fixed machine? Would this not be a generator?

Let's flip it around again. Could not a flying version of T. T. Brown's charged capacitor have gotten charged via decay of radioactive material with accompanying hardware similar to what has been described above?

One more point should be made concerning the possible relationship between atomic energy and field propulsion. We do know that electromagnetic radiation can be generated by atomic fission or fusion. This is done whenever nuclear weapons are detonated. It is called an electromagnetic pulse. This is a well-recognized phenomena and the military's communications and sensitive electronics have to be "hardened" against this electromagnetic pulse as a battlefield necessity. So the relationship between electromagnetic and atomic energy does exist. The question still remains as to a

technological breakthrough in the application of this phenomena and to whether the Germans pioneered this effort involving flying craft.

#### Atomic/Field Propulsion Sources

1. United States Patent, Patent Number 5,443,857, August 22, 1995, granted to Howard C. Rivenburg, "Power Source Using APhotovoltaic Array And Self-Luminous Microspheres".
2. United States Patent, Patent Number 5,642,014, June 24, 1997, granted to Steven J. Hillinlus, assigned to Lucent Technologies, Inc., "Self-Powered Device".
3. United States Patent, Patent Number 4,835,433, May 30, 1989, granted to Paul M. Brown, assigned to Nucll, Inc., "ApparatusFor Direct Conversion Of Radioactive Decay Energy ToElectrical Energy".
4. Lifetime Batteries, 13A and 13B, contained in catalog ofEnergy Research Company, P.O. Box 1514, Jackson, CA. 95642
5. Freeman, Gordon Dr., personal letter to author dated 3/7/02
6. United States Patent, Patent Number 3,949,178, April 6, 1976, granted to Sten Hellstroem and Rolf Bertil Goeran Joenson,assigned to Telefonaktiebolaget L M Ericsson Bundersarkiv, Postfach 450569, 12175 Berlin,
7. file on Dr. W. O. Schumann, courtesy of Mark D. Kneipp.
8. Foreign Scientists Case Files, 1945-58 "Winfreid Otto Schumann", Location Box 151,631/26/01/07, The NationalArchives, 8601 Adelphi Rd., College Park, Maryland 20740, Courtesy of Mark Kneipp
9. British Intelligence Objectives Sub-Committee Final Report Number 1043, item number 31, "The Invention of Hans Coler, Relating To an Alleged New Source of Power", Bryanston Square, London

#### [Chapter 4 Index](#)

#### [Main Index](#)

## The Karl Schappeller Device

Was the Schappeller device an engine used in German field propulsion saucers? This is a possibility. Because so little has been reported about this device in the English language, the following is a report describing Karl Schappeller and his device in some detail.

Karl Schappeller (1875-1947) literally went from being born in poor house to owning a castle during his lifetime. His economic success was mirrored in his experiments in energy as a lay-scientist, culminating in the invention of a free-energy device which attracted considerable attention around 1930. Schappeller made no secret of his invention and actively sought private financing to manufacture and distribute the results of his research. He was in touch with financial concerns and even spoke with a representative of the British Admiralty concerning the utilization of his device to power the Royal Navy's ships (1).

At this time, 1930, the device was somehow appropriated and further worked upon by a governmental organization of the German Weimar Republic, the Reichsarbeitsgemeinschaft or Reich Works Association (RAG). At least one aim of the RAG was to make Germany self-sufficient in energy production. Specifically, they published their intentions to utilize many Schappeller devices in a system of broadcast energy distribution throughout Germany which would result in the entire elimination of the electrical grid (2). As we know, Adolf Hitler assumed power three years later and was also very interested in making Germany independent of foreign sources of energy for strategic reasons. It is known that political and scientific structure was set up to work on the energy problem as evidenced later by the synthesizing of gasoline and oil products from coal by the 3rd Reich. One of these political and scientific structures was contained within the SS and it is known that Karl Schappeller actually met with SS Reichsfueher Heinrich Himmler in Vienna in 1933 (3).

#### Schappeller

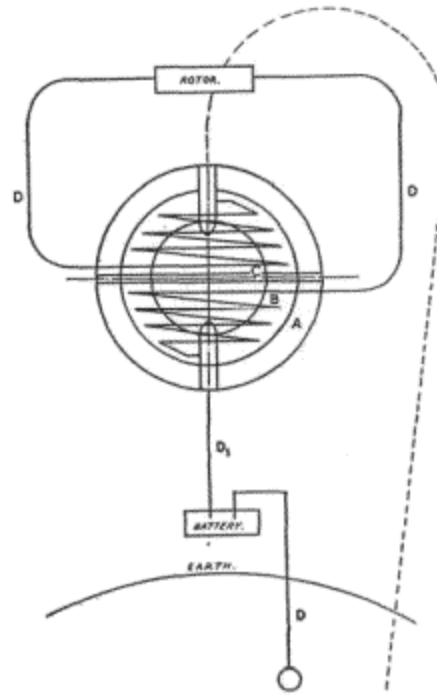

Left: Inventor Karl Schappeller Right: Karl Schappeller's Device. A. Steel outer casing. B. Special ceramic lining in which tubes are embedded. C. Hollow center, filled by glowing magnetism when in operation. D. Tubes, circuit and earthing.

Fortunately, there are good descriptions of the Schappeller device in both German and English languages upon which to draw. Per Vrill-Mythos is a complete discussion of Schappeller, his device, the history and the controversy surrounding it. "Vril"Die Kosmische Urkraft Wiedergeburt von Atlantis and *Weltdynamismus Streifzuege durch technisches Neuland an Hand von biologischen Symbolen* represent an attempt by the RAG to popularize their ideas in booklet form. Finally, British electrical and mechanical engineer, Cyril W. Davson, visited Karl Schappeller in Austria and spent three years learning of his device and his theory before the Second World War. Davson's descriptive book, *The Physics of the Primary State of Matter*, was written in 1955, after the war and the death of Schappeller.

Before describing the device itself it should be understood that Schappeller and all writing about his device do so believing that the energy-source being tapped is aether energy, sometimes called "Raumkraft" or "Raumenergie", that is space energy (4)(5)(6). This device was also said capable, perhaps with some tuning, of emitting aether as a radiant energy (7). The physics of aether energy is described by Davson as a primary physics as opposed to conventional physics which he believed could only be considered a secondary, derivative understanding.

### Aether Theory

For readers who have never heard of "aether", perhaps the simplest explanation for aether physics is that of the late Dr. Hans A. Nieper (7) titled *Revolution in Technology, Medicine and Society*. aether could be thought of as an energy source emanating from everywhere equally at once. The universe could be considered, as often said, "a sea of energy". It forms a background of energy everywhere, and since it is everywhere all the time, it is difficult to make independent measurement of it. This aether energy is in constant motion. All energy is radiant energy, according to this theory. This can easily be appreciated as to electromagnetic radiation but it is also true of that very elusive thing called gravity. Newton described the effects of gravity but he never told us exactly what it was. Dr. Nieper tells us that gravity is really a push, not a pull. Gravity is acceleration and is caused by the aether field. Again, all energy is radiant energy whose fundamental basis is aether radiation.

From the aforementioned book by Dr. Nieper:

"In addition, Nieper established the axiom that all natural accelerations can be attributed to a single unified basic principle, namely, the interception (or braking) of a field energy penetrating from the outside (gravity acceleration, magnetic, electromagnetic, electrostatic and radiesthetic acceleration)."



In trying to explain aether, it might be thought of as an all pervasive liquid occupying all of space. This liquid concept is useful because a liquid can not be compressed but can only transfer the energy attempting to compress it from one location to another. This is how an automobile's brakes work. The driver pushes in the break pedal when he wants to stop. The plunger of the break pedal attempts to compress fluid in the master cylinder. The master cylinder is connected by metal tubes full of fluid to each wheel. When force is put on the master cylinder by the driver it is transmitted to each of the four wheel cylinders full of the same fluid which transmit the force, moving the break shoes or stopping the disc which stops the wheels of the car.

Likewise, aether serves to transmit energy through this "non- compressibility" quality. In a primary electric coil and secondary electric coil, for instance, induction in the secondary does not take place directly from the primary as is new held by physics, but though and between the two via the aether field. This concept, that of the stimulation of the aether field as means of energy transport, is also expressed by Davson.

Using this perspective, that all energy is radiation, the braking of aether radiation, that is the slowing down or stopping of this radiation, can cause or generate other forms of energy. This word "energy" means the entire electromagnetic spectrum. This means electric, magnetic and electrostatic fields. This means heat. This also means gravity. Again, gravity is the primary radiation of the aether field. It radiates from every point in the universe equally.

This concept seems ridiculous until it is given some thought-One might ask: How can gravity be a push when we know better? After all, things fall to earth don't they? The answer is that the effects we feel and call gravity are due to gravity shielding. aether radiation can be braked, that is slowed down and absorbed by mass. It is then re-radiated or turned into mass. It is re-emitted as slower aether radiation or even as heat. Some of it can is converted into mass inside a planet. If there is a loss of aether radiation, then there is shielding. Thus, a planet would shield from this radiation in one direction. That direction is always toward its center which is the direction of greatest mass and that is what we describe as "down". This is simply the area which contains the maximum amount of shielding. In all other directions the aether radiation continues to exert its push on us. The area of minimum shielding is directly opposite the area of maximum shielding, so things fall (or more correctly are accelerated or "pushed") to earth.

Think about this for a minute. Being in deep space is a little like being underwater. Underwater, all pressure from all points are so similar that we feel weightless. We are weightless in deep space because the aether field exerts a push on us from all directions equally. In space, the nearer one gets to a large body the stronger the push is from the opposite direction since the body shields or converts the aether radiation. The result of this thinking is a mechanism totally different from "gravity" as we know it but appearing as exactly the same observed phenomena.

The beauty of this aether theory of gravity is that gravity functions like every other form of radiation. Its underlying cause, aether radiation, can be converted to mass or, in certain circumstances, re-radiated or converted to other forms of energy. No Unified Field Theory is necessary. The aether field is the unified field. Further, there is no need to look for something separate called "anti-gravity". If gravity is a push then it is all anti-gravity. All we have to do to make a UFO is to find this particular gravity frequency and find out how to generate it.

aether physics was a lost physics. Physics was hijacked early in the 20th Century by alleged results of the Michelson-Morley experiment. The Michelson-Morley experiment assumed "aether" was matter. There is some confusion here. We know now that particles moving near the speed of light are measured as waves, that is energy, rather than as matter. Nevertheless, aether theory has been discredited among physicists who, in turn, discredit others who raise the subject. It is only through the efforts of "free energy devices" and free energy researchers that this knowledge is being returned to us. Without this aether theory, the reason these devices work cannot be explained at all. Rejection of aether theory allows these devices to be dismissed as "theoretically impossible" and so fraudulent by simple deduction. They are marginalized and dismissed as "perpetual motion devices". According to established physics, perpetual motion devices violate physical laws of conservation of energy. Without an aether theory as an explanation, they do violate laws of conservation of energy and so their detractors are able to simply dismiss them out of hand. The simple fact that some of these free energy devices actually work does not seem to bother these scientists in the least. Rather than change the theory to accommodate the observed facts, the facts are ignored and substituted by dogma. Whether we like it or not, we are living in an energy Dark Age.

Instead of aether theory, we have all been led to focus upon Einstein and his Theories of Relativity. Two or three generations of scientists have wasted themselves on "trying to prove Einstein right". This misguided thinking has resulted in stagnation. One need go no further than the many "free energy" devices which have arisen to the level of notice in spite of accepted scientific theory to see that this statement is true.

Needless to say, German scientists of the Nazi period labored under no such illusions. They never abandoned aether physics. This was the fundamental reason why field propulsion UFOs were first developed in Germany. After the Second World War two different sciences developed called "Physics". One was the relativism taught in schools. The second more esoteric type was utilized only secretly, by the secret government, for deep black projects.

### **Structure of the Schappeller Device**

According to Davson's description upon which we will rely, the Schappeller device is really composed of two separate units, the rotor and the stator. The stator is constructed as follows: Its surface is round or ball-shaped, being composed of two half-shells of steel. These half-shells contain the internal structure and are air tight. Attached at each "pole" of each half-shell is an iron bar magnet, most of whose structure is internal. This means that the bulk of the magnet is inside the steel ball, one opposite the other. There is a space between the two bar magnets at the very center of the sphere.

Insulation, a ceramic material, is placed on the inside of the steel ball leaving a hollow central area. Within this hollow area and around the space between the magnets are wound two internal coils. These originate at the bar magnet poles and each terminates at the center of the sphere with a connection leading out of the sphere to the rotor. These coils are composed of a hollow copper tube filled with a special and secret substance called the "electret". Upon leaving the sphere the electret filled copper tubes are replaced by conventional copper wire. An electrical connection is made from the outside surface of one pole to one pole of a special type of battery which is grounded at the other pole or, as an alternative, to a special device called an "Ur-machine" which will be discussed.

This electret is a permanent magnet within the sphere. This type of magnetism is not identical with ferro-magnetism or electromagnetism, it is much stronger (8). The actual composition of Schappeller's electret remains a secret but another electret has been made by Professor **Mototaro Eguchi**. It consists of carnauba wax and resin, perhaps also containing some beeswax. It was kept in a strong electric field while baking slowly until it solidified. For purposes of production of Schappeller spheres, a complete electret manufacturing plant would have to be set up which had no parallel in present science (9).

Before being set into operation, all the air is pumped from the hollow core of the sphere. This whole ball is mounted on a swivel mechanism so that the poles can be moved from the vertical to the horizontal. The stator is completely unattached from the rotor. The stator can function without the rotor and the stator is capable of producing electrical energy without the rotor. The rotor could also be used to generate additional electrical energy.

The rotor consists of: A steel wheel of special design fixed on the shaft to be driven and surrounded on its outer surface by magnets which are attracted and repelled by the force of the stator. The copper wire attached to the internal copper tubing filled with electret runs through this wheel and supplies electric power to the magnets. The magnets are hollow and filled with the same electret. There are always an odd number of magnets.

A variant of this rotor comes to us from Taeufer, who refers to this further development as the "Ur-Machine". This machine is composed of six sphere units as described above, five revolving around a sixth set above or below the plane of the other revolving spheres. A seventh unit would be employed to rotate the rotating five spheres and so would be offset, and not attached to the others. The five rotating spheres would charge the sixth stationary sphere. The sixth and seventh spheres would function as an anode and cathode and so ground the unit. The Ur-machine could be used to activate other spheres instead of a battery-earthing procedure (10).

As a prime mover, an engine, the rotor would be employed turning a driven shaft. The stator would be offset, that is, moved off center in relation to the rotor. Schappeller worked out various angles of efficiency (11). The driven shaft could be used to power any number of machine applications such as, for instance, the propellers of a ship.

### **Means of Operation**

The device is started through totally unique battery and a connection to the earth (12). A specific excitation impulse must be given to the device (13). This electric impulse was conducted through the iron magnet and jumped the gap in the center of the sphere to the other iron magnet.

What occurred then sets this device apart from all others. In the vacuum of the sphere, in the center space between the two bar magnets a field of "glowing magnetism" was set up. This glowing magnetism was something entirely unique. It is recognized as a magnetic field but much more powerful and unlike any magnetic field of an iron bar or an electric coil. Once the initial input had been made to start the device, the battery and ground could be disconnected. The device would continue to operate on its own (14).

For an understanding of what is really happening here we have to consider the bar magnet. We think of a bar of iron with two poles, one positive and one negative or perhaps one north and one south pole. But there are really three components to the bar magnet. There are the two poles and the neutral zone between the poles. If we cut the magnet in half we get two new poles. For the Schappeller this neutral area is very important. Imagine a bar magnet running through the vertical axis of the ball. Then imagine the center section cut out. We now have a north pole at the top of the ball, a south pole at the bottom of the ball just as we do with the planet Earth. In the center we have a missing section with a south pole, opposing the north pole at the top of the ball and, likewise, a north pole opposite the south pole at the bottom of the ball. We have now four poles and a split bar magnet with a gap in its center section.

It is this gap in the center where Schappeller's "glowing magnetism" is generated by grounding, that is, charging the device via a special battery and an earth connection. This glowing magnetism is the mystery. Davson cites Schappeller's calculations and gives this form of magnetism as being one thousand times more powerful than that produced by present magnetism (15). He also states that in this form of magnetism the electricity is stationary while the magnetism is radiated (16).

To repeat again, Davson contends throughout his book that this glowing magnetism is not found in secondary physics, that is, in modern physics, and that this glowing magnetism is a manifestation of primary physics. As a phenomenon of primary physics, it is responsible for and can generate heat, electricity and magnetism.

After initial stimulation and in a state of glowing magnetism, no further input of energy is needed from the battery. The device is able to draw in energy to it directly from the surrounding aether, bind this energy through its magnetic electret material, that is the filling in the hollow copper coils of the internal coil, and then re-radiate energy producing heat, electricity, magnetism or mechanical work depending upon the application.

Stated another way, this is an implosion device and it is described as such (17) (18). Unlike the Schauburger device which is associated with the word implosion, the Schappeller device operates purely at the energetic level. Energy is drawn towards the center, through the magnets, into the field of glowing magnetism, and then radiated outward.

My first explanation for this output of radiant energy involves the concept of the Bloch Wall. A Bloch Wall is defined by Van Norstrand's Scientific Encyclopedia, 1958 edition, pages 201 and 202, as follows:

"This is a transition layer between adjacent ferromagnetic domains magnetized in different directions. The wall has a finite thickness of a few hundred lattice constants, as it is energetically preferable for the spin directions to change slowly from one orientation to another, going through the wall rather than to have an abrupt discontinuity" (18).

In electromagnetics the Bloch Wall is external to the hardware itself. It is the point of division of the circling vortex, or spin, of the electronic magnetic energies of the north and south poles. The negative north pole magnetism spins to the left while the positive south pole spins to the right. Energy is being conducted into the Schappeller device through the un-insulated poles and being conducted and spun on its way to the center of the unit. The point of zero magnetism, no spin and magnetic reversal, where the two spin fields join, is the Bloch Wall (19).

### **Bloch Wall And Oscillating Circuit**

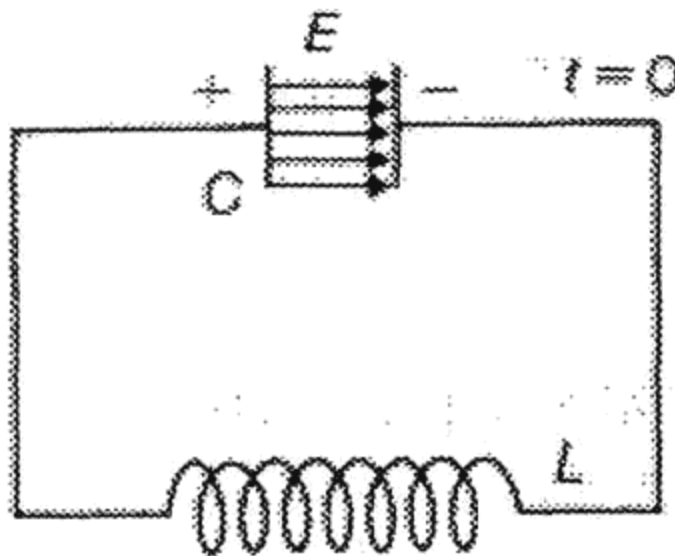
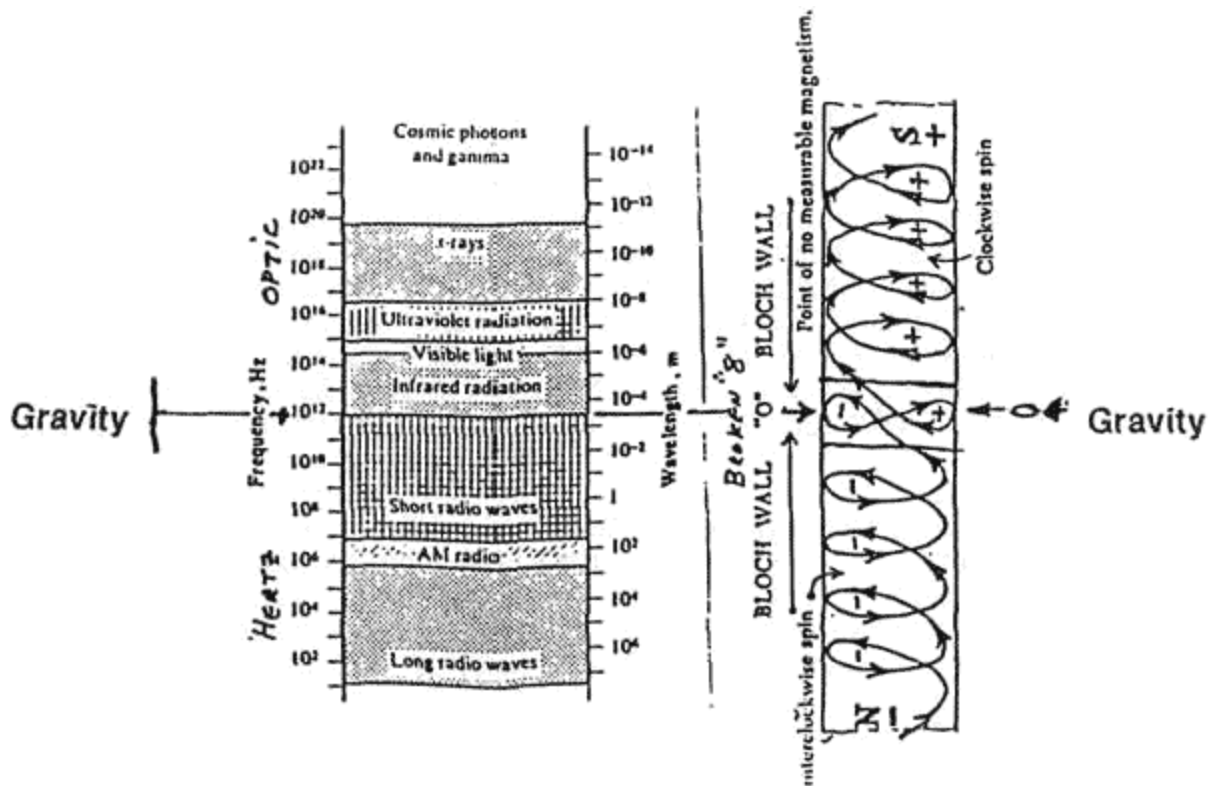

Top: Bloch Wall, a gravity wave source as a function of the electromagnetic spectrum? (Dr. Richard LeFors Clark) Bottom: Oscillating circuit. Charged capacitor (electric field) discharges, current carried through insulated wire to charge coil (magnetic field) which discharges, charging capacitor. Oscillating electric and magnetic fields yield electromagnetic waves.

The Bloch Wall radiates energy. Remember, if energy is coming in then it must be going out. The Bloch Wall may generate radio, radar and other electromagnetic frequencies but what is most interesting is that it is actually able to radiate gravity as according to Dr. Richard Lefores Clark. According to this interpretation, the conjunction of two dipolar generated force field vectors, a quadrupole force field or gravity is generated according to Dr. Clark. Gravity being a quadrupole source, radiates in a circular, 360 degree, pattern of two cycles. Dr. Clark has fixed the point of emission as below that of radar and above infrared at 10 to the twelfth power Hertz (20). Dr. Richard Lefors Clark believes gravity is a radiation (21) and so a "push".

### Another Opinion

In late 2001, I wrote a magazine article on the Schappeller device (22) which contained most of the material described above. In that article a request for alternative explanations for the Schappeller device was made. I received a letter from Mr. Michael Watson, BSc, Chartered Physicist and Member of the Institute of Physics in the United Kingdom. But there was something in Mr. Watson's background even more impressive than his professional credentials. Cyril W. Davson was a family friend whom Mr. Watson knew well in his youth and with whom he had discussed Schappeller and his ideas at length, many times. In Mr. Watson's letter was a brief summary of Schappeller's theory in which he cut through most of the confusing terminology.

This summary is important for a couple of reasons. Mr. Watson's summary of Schappeller's aether theory as described by Davson dovetails nicely into the ideas of Schauberger yet seems to allow for Tesla's experimental results on aether as explained by Bill Lyne. The following is what I learned from Mr. Watson's letter:

Most of us have heard of the two Thermodynamic Laws. These are laws of heat. The First Law of Thermodynamics states that energy is conserved, meaning that the total amount of energy in the universe always remains the same. This is no surprise for most of us and it is not the real concern here.

What is of concern is the Second Law of Thermodynamics which discusses heat and entropy. The word entropy might be thought of as a state of randomness or chaos. Negative entropy would then mean movement toward the less random or the more ordered in any particular thing. If we apply this to a system, then entropy tends to increase until the system breaks down in utter chaos

This will occur unless the system is re-charged with additional outside energy. A concrete example is less confusing.

Imagine a new automobile just coming off the assembly line. It has taken a great deal of energy to find, refine, forge, weld, and paint the metal parts of this car alone. This same concept also applies to all the other components of the car. This energy and organization constitute a highly organized state, or, said another way, a state of negative entropy.

What happens next illustrates entropy. The car is purchased. Whether it is driven hard or just sits in the garage does not matter in the long run because what happens to the car is that it starts to fall apart. This change may be small at first and may only occur at the molecular level, but it occurs nevertheless. The engine, transmission, paint, rubber, electronics, etc. all will fail with time. Even if the car just sits in the garage, in a thousand years the metal will eventually oxidize. Finally, the car rusts away forming a reddish brown heap. This is exactly the opposite of the organization and energy used to put the car together. This disorganization is entropy. The only thing which will reverse this, as we all know, are additional inputs of energy by the owner in the form of maintenance and repairs.

All things in a relative state of relative order move toward a state of disorder. In terms of heat, heat will always flow into a colder place from a warmer place. When something is heated there is a rise in its entropy. With increasing heat its molecules move faster and faster in random chaos as a bomb does when it explodes. Increasing heat means increasing randomness and chaos which is entropy. Cold, then, can be seen in terms of negative entropy. Any cold object is simply more organized and less random than the same object once it is heated.

Schappeller had something to say about the Second Law of Thermodynamics. He said there was another and unknown thermodynamic cycle which runs opposite the Second Law. To name this idea we will call it "Reverse Thermodynamics". It is the reverse of the Second Law of Thermodynamics in that it leads to an increase in entropy. Not only is there an increase in order but there is an increase in cold! Schappeller, according to Mr. Watson's letter, built his spherical device primarily to demonstrate the principles behind this Reverse Thermodynamics. It was not designed as a practical machine.

To demonstrate the difference between the Second Law of Thermodynamics and Reverse Thermodynamics two theoretical machines shall be examined. Actually, a machine running according to the Second Law of Thermodynamics is not theoretical at all. Combustion machines are of this type. For simplicity sake we will use a wood burning stove such as the type invented by Benjamin Franklin for the heating of a house.

Wood is put in a hollow iron vessel with an adjustable hole at one end. The adjustable hole admits atmospheric oxygen. An initial small input of heat is added to the wood and oxygen until burning occurs. A great deal of heat is produced once the wood begins to burn. We know heat expands. Carbon, carbon dioxide and water vapor are also produced as byproducts of the combustion. Entropy is increased. Since entropy is increased, so is pollution so perhaps we all can agree that this is a good example of the destructive technology so characteristic of the world in which we live.

In our example of a theoretical Reverse Thermodynamic machine the byproducts of the previous example can be used as fuel. But Schappeller's machine has the additional property of being creative, that is, negatively entropic. Schappeller

believed this creative process to be individualistic, so we need a specific template to use as a pattern for this creation. Heat, water, and carbon dioxide are imputed into this machine. Quite amazingly, oxygen is yielded as a byproduct of this reaction! The heat is also absorbed in Schappeller's Reverse Thermodynamic machine! This absorption of heat is another way of saying that the machine is implosive in nature rather than expansive or explosive as was the heat producing machine. What is most amazing, however, is that entropy is actually reduced yielding, something which has been created -wood!

Actually, this machine is not theoretical either. It exists and works as we speak. These machines are all around us. We call these machine "life". In this case our machine is a tree. In the tree, energy, sunlight, is absorbed and combined in a cold process with water and carbon dioxide to form wood. The template used as a pattern for this seemingly intelligent, creative, process is simply a seed. In this type of reaction the "cold" force is something other than the absence of heat. This cold is an active cold. It is a "densifying", implosive cold. It is a life-giving cold. This is a cold, life giving force. To quote Watson:

"This process is life force and the reverse of the second law of thermodynamics; it is the vital force: Vril."

This is one huge difference between the physics of Schappeller and Schauburger and the physics of the Nineteenth Century. The physics of the Nineteenth Century explain everything in terms of the inanimate. Laws of physics are written using inanimate examples. Chemical reactions are described which stem from inanimate models. Animate models are simply made to conform with the inanimate assuming that life is just a special case which eventually will be shown to be nothing but chemistry and so subject to the same Second Thermodynamic Law as the inanimate. Schappeller and Schauburger both say in their own ways that this is not so. They say, each in their own ways, that a new and different law of thermodynamics applies to living forces. They say that this more akin to a life process than previous theories allow. They say this force is creative. Those that subscribed to these new ideas claim it was not only a new physical law but anew science and that Germany would lead the way to this new science. Let us take a closer look at what is claimed to be the physics behind this new science.

The first concept to be considered is cold. Cold in this sense does not mean the mere absence of heat. This is interstellar cold, the cold found in the vacuum of space. In this relative vacuum, matter is not found in sufficient quantity to use to measure this cold. Think about how we measure cold. We measure matter which is cold. We measure the heat in air or water for instance. In the absence of matter how would cold be measured? There is no doubt that if we could, for instance, place a thermometer in a glass of water in deep space, the temperature recorded would be at or very near absolute zero, 0 Kelvin or -273degrees Centigrade or -460 degrees Fahrenheit.

The presence or absence of matter in deep space may be the subject of conjecture. The presence or absence of energy in deep space is something universally accepted. For instance, we all know that light passes through interstellar space. We see the proof when we look up at the stars, planets or the moon. Besides visible light, other electromagnetic radiations freely pass through space. These include x-ray, gamma and cosmic rays. Yet besides electromagnetic radiation many people now believe that in the depths of space there resides another form of energy with is found there as well as everywhere else all around us. This energy sometime goes by the name of "zero point energy" but for our purposes we can simply call it "aether energy". It is sometimes argued that this energy is really the result of aether rather than aether itself and that aether really is matter. For a moment, let us postpone this discussion and focus on the vast, stretches of interstellar space which are filled with aether energy, near or at absolute zero.

Mr. Watson points out Dawson's words on page 83 of The Physics Of The Primary State Of Matter where he says:

"Cold is not therefore the absence of heat, primary heat and cold having nothing to do with molecular action (in the cosmos) there are no molecules available".

The reader may recall that something strange happens to electrical energy at absolute zero. For instance, if a disc of conducting material is held at absolute zero and the disc is given an electric charge, the electric current will circulate around and around the disc forever, never losing its energy a sit would if the disc were sitting on an office desk at room temperature. This property of cold is instrumental in the storage of at least one form of energy. The vast stretches of cold interstellar vacuum must be seen as a vast energy storage sea in a state of heightened negative entropy. Schappeller called this undirected matter-energy reserve potential "latent magnetism."

Out of this latent magnetism, both energy and matter could be produced with the corresponding stimulation. The non-excited electromagnetic field was viewed by Schappeller as simply latent magnetism. Matter is a condensation out of bipolar aether. Therefore, electromagnetism is a product of matter and is nothing more than bipolar aether in a different condition. Latent magnetism could be, then, excited into matter. Latent magnetism could be influenced by either of the

thermodynamic principles discussed, the Second Law of Thermodynamics or by Reverse Thermodynamics. This vast aether field, whose most notable characteristic is the property of cold, latent and awaiting stimulus, is the progenitor of both energy, as we know it, and of matter.

Since primary cold, this vast reserve of negative entropy potential, is responsible for both matter and energy and since all energy eventually degenerates into heat, it follows that, asnavson puts it, again on page 83:

"Primary heat, as may now be understood, is composed of cold energy".

This seems like a surprising play on words, especially from a man of science, but this statement follows perfectly from Schappeller's reasoning nevertheless.

We turn now to Schappeller's concept of "stress". Both heat stress and cold stress can be applied to an electromagnetic field. Heat stress is the usual type of stress applied to electromagnetic fields in secondary physics. Secondary physics is the physics of our everyday world according to Schappeller. Primary physics is the physics dealing with the cold force and aether yielding matter and energy, which constitute the secondary reactions and so Schappeller uses the term "secondary physics" to describe our world as we know it.

An example of heat stressing of the electromagnetic field is the condenser and the coil. A charged condenser results in an electric field and a charged coil results in a magnetic field. A charged condenser and coil, connected by a wire circuit alternately charge and discharge each other, producing electromagnetic radiation until the heat caused by the resistance of the wire degrades the whole process into heat. Heat stress on the electromagnetism is +/-.

Cold stress on the electromagnetic field is something totally new to our science and technology. It is also seen in terms of +/- but the machines used to produce it are not known in our world. Mr. Watson did not say this but if we return to our examples of heat stressed machines, the condenser and the coil, the corresponding cold stressed machines might be the Schappeller sphere and the Schappeller coil electret. The sphere collects the charge through the magnets, holds and condenses it in its glowing center corresponding to the electric field of the condenser. The internal coils filled with electret produce a magnetic field in the presence of the intense and pulsing electric field. According to my interpretation, the whole Schappeller sphere is a combined condenser/coil combined into one machine made possible through an initial input of cold stress.

As in our example of the condenser/coil interaction producing an electromagnetic wave, so an attraction exists between a machine obeying the Second Law of Thermodynamics and one obeying the law of Reverse Thermodynamics. This attraction can lead to interaction. For instance, an imploding or centripetal vortex can couple with an exploding or centrifugal vortex. The centripetal vortex is an example of a system following the law of Reverse Thermodynamics while the centrifugal vortex represents a system following the Second Law of Thermodynamics. We have all seen these two systems working together in everyday life. The common toilet is such a machine although the centrifugal side forms inside the drain pipe which is out of sight.

Perhaps there is another example which is more germane to our discussion. It is the diagram of the Vril power plant. (This engine diagram is used here as an example for discussion and is not a blind endorsement of the diagram's existence or accuracy.) In this interpretation of this diagram, we are really dealing with two separate devices. First, is the central spherical device which may be a refined version of the Schappeller sphere. An initial charge would be imputed into the sphere to start it after which the unit would continue to gather up the surrounding energy. This is a Reverse Thermodynamic machine. The sphere generates a magnetic field which could be offset by rotating basin the Schappeller device. The offset field would feed and so rotate the arms of the electric generator surrounding the sphere. The electric generator would gather electric energy, feeding the four large broadcasting fixtures on the walls of the saucer. These fixtures might be, for instance, Tesla pancake coils. The electric generator is an example of a machine complying with the Second Thermodynamic Law.

Both components of the power plant are bonded together in a single system since the output energy of the broadcasting fixtures on the walls of the saucer constitute additional input energy for the sphere. The two components attract one another and use and depend upon one another as they circulate and recirculate energy. As the energy level of one component increases so does the energy level of the other. Indeed, the biggest problem facing the use of such an engine may be employing means to stop it.

The actual levitation might be the particular electromagnetic radiation coming out of the sphere. In this interpretation, the broadcast fixtures are used to steer the saucer. Davson gives output frequencies for the sphere as 10 to the sixth power (22).

Mr. Watson points out in his letter that one reason machines utilizing the Reverse Thermodynamic principle have not been recognized is that a cold stressed magnetic field is a cold machine. Even a centripetal vortex cools rather than heats. All our devices of measurement ultimately measure heat in some form. Measurement of cold is more difficult. The example already given, the problem of measuring temperature in interstellar space in the absence of matter is an example of this problem.

Finally, the reader will recall that Mr. Watson points out that electromagnetism manifests itself bipolarity, yielding four components in all. These are +/- hot electromagnetism and +/- cold electromagnetism. The reader will recall that two hot electromagnetic components can be joined (the condenser and the coil) and set into a cycle producing an electromagnetic wave. It is possible that two complementary hot electromagnetic and cold electromagnetic machines could be set into cycle producing not a bi-polar but a quadropolar, 360 degree radiation, such as the one described by Dr. Richard Lefores Clark, to produce gravity?

### **Planned Uses For The Schappeller Device**

If the above discussion has any meaning at all in the quest for an answer to the UFO question, one use for which the Schappeller device must have been destined was that of a power plant for a flying machine. Was this so? The Schappeller device had many planned uses. In 1930 this device was planned as a source of broadcast energy, reminiscent of Tesla, for both German homes and industry. The device could also be used as a generator, battery, transformer, or antenna (23). It is reported that toward the end of the war the SS researched the possibility of using this device in the form of a death ray (24). But additionally, and in answer to our question, the Schappeller device was envisioned as a levitation device for a flying machine. Here is some of that discussion from our sources:

"The new dynamic technology will, in the future, be able to drive electric locomotives and automobiles without the manufacture of costly armatures and everywhere through connection to the atmospheric voltage network. Hypothetically, is certainly the installation of a sufficient number of central amplification facilities which transports from the Ur-Machine the specific magnetic impulse from the dynamic spherical element. New types of aircraft with magneto-static power devices and steering, which are completely crash and collision proof, could be built for a fraction of the cost of today's aircrafts€"and without the lengthy training of everyone who will be servicing these aircraft".

From "Vril" Die Kosmische Urkraft Wiedergeburt von Atlantis by Johannes Taeufer, page 48.

"Our problem must be to drive toward the space ship problem to new understanding of a realization! Here a definite postulate can be established: "Spherical space ship with its own atmosphere€"also technical creation of small planets with world dynamic propulsion and buoyancy!".

Will this be possible? --

Major powers in the world prepare themselves in any case presently, especially in Germany."

The above from Weltdynamismus Streifzuege durch technisches Neuland an Hand von biologischen Symbolen. pages 11 and 12. Please note the use of the words "spherical space ship"(Kugelraumschiff).

From Davson in The Physics Of The Primary State Of Matter, page 240:

"The Rotor is laminated to prevent eddying and the magnets do not project; the Rotor periphery is thus entirely equiradial. The Rotor is fixed to the shaft to be driven and the Stator is fixed about a metre above the earth's surface. The latter is, of course, flexible because the earth can include the sea or even the floor of an aether-ship."

From Davson, page 199:

"As has already been explained, the new Technique will not concern itself with the air as a supporting medium, but directly with the aether. Therefore, the body may be a vertical sealed cylinder with conic ends or any other suitable form. Such a body is obviously rigid and inelastic, and it must contain an aether stress of sufficient intensity to support its mass against the stress of the earth's stress field, which means that the glowing magnetism core in the Stator, provided in the body to be lifted, must be able to vary its intensity according to the height at which the aether-ship is to be raised and supported whilst in transit, as the aether stress or field, itself, varies inversely as the square of the distance from the earth's surface. The actual design and solution of all the various problems in the production of such ships, the choice of methods



of propulsion, whether independent or directional, belong to the new Technique, whereas here we are only interested in the principle as applied to the problem of Gravitation."

Finally, from Davson, page 177:

"Now the reason that an unsupported body falls to the ground is primarily because it has "no hold" on the medium. It was previously explained that any inert mass or body has only a latent stress field which functions merely as the force of cohesion and has no mobility and thus only a latent internal stressfield and no external stress field. This means that it has no "hold" on any elastic medium such as the aether or the air, therefore it must fall, and it falls towards the greater inductive energy.

If the inductive energy, through some exterior cause, could be made suddenly to increase enormously, there would come a point when the body would be supported, or rather suspended, before it reached the earth's surface.

The new Technique could accomplish this by placing a Schappeller Stator in the body in question, where the body is suitably constructed, thus setting up a glowing magnetic stressfield which would hold or keep the weight or mass of the unit body suspended, not in the air—the stress field would have no reaction on the air—but only on the earth's magnetic stress field.

This is the basis of the new principle for "aether ships"

Employing the Schappeller mechanism is only half the total explanation. In a field propulsion saucer there are possible two types of "drive" needed. The first is the "Auftrieb" or levitation. Employment of levitation makes the craft buoyant. It weighs nothing. If it weighs nothing it can be moved very easily. "Antrieb", impulse or motive power is the second drive involved. It moves the craft directionally. Levitation only would be supplied by the Schappeller system. Directional movement is so far best explained, in my mind, using the Tesla pancake coils as explained by Bill Lyne.

### **Concluding Thoughts on the Schappeller Device**

In the end, what can be said of the Schappeller device? certainly, it did exist. It drew attention and funding from people within the German government of the time. It was studied by a qualified outsider, a British engineer, for a period of three years and was judged to be genuine.

There are some obvious problems, however. Exotic energies have been evoked which have not been explained satisfactorily. Therefore, the facts are not in evidence yet. Certainly more proof is required before the claims made for this device or the energies involved can be wholly accepted. For the time being we must put this discussion aside, awaiting further correlations.

There are some solutions connected with this device also. If we accept the idea that both the Schauburger and the Schappeller devices worked on the theory of implosion, then one explanation will serve to explain them both. It also allows for an aether-as-matter explanation. This may fit into the evidence gathered by Nikola Tesla. The commonality of these devices could then besought and perhaps a more efficient device built as a result. We will pick up this theme again in the discussion section of this book.

It should be pointed out that the quest for this "new science" is not specific to Schappeller or Schauburger. Mr. Watson passed on these words from Ehrenfried Pfeiffer, a scientist who collaborated with Dr. Rudolf Steiner around 1920. Although he is not happy with the translation he sent it as he found it which is as it is presented here:

"...the method of science, in a materialistic sense, is based on analysis splitting apart, disintegration, separation, dissecting and all the procedures which have to destroy and take apart, to work on the corpse rather than to grow, to develop, to synthesize. That the human mind was captured by these methods of braking apart: in that I saw the source of our present situation. My question therefore was: (to Rudolf Steiner) is it possible to find another force or energy in nature, with does not have in itself the ductus of atomizing and analysis but builds up, synthesizes. Would we discover that constructive force, which makes things alive and grow, develop adequate building up of methods investigation, eventually use this force for another type of technic, applied to drive machines, than because of the inner nature of this force or energy we might be able to create another technology, social structure, constructive thinking of man rather than destructive thinking. This force must have the impulse of life, of organization within itself as the so-called physical energies have the splitting, separating trend within themselves.

My question to Rudolf Steiner October 1920 and spring 1921 therefore was: does such a force or source of energy exist? Can it be demonstrated? Could an altruistic technic be build upon it?"

My questions were answered as follows:

"Yes, such a force exists, but is not yet discovered. It is what is generally known the aether (not the physical aether) but the force which makes things grow, lives for instance in the seed as Samenkraft. Before you can work with this force you must demonstrate its presence. As we have reagents in chemistry, so you must find a reagent for the aetheric force. It is also called formative aether force because it is the force which relates the form, shape, pattern of a living thing, growth. You might try crystallization processes to which organic substrata are added. It is possible then to develop machines, which react upon and are driven by this force. Rudolf Steiner than outlined the principles of the application of this force as source of a new energy..."

Since this quest for a new science with the accompanying new machines had a relatively long history in Germany, certainly pre- dating the 3rd Reich, it is almost certain that the Schappeller device or others built along a similar understanding were further developed during the Nazi period. What became of it after the war is unknown. It can be assumed that this device did not escape the scrutiny of the numerous Allied intelligence units tasked with combing Germany for examples of German science. Perhaps someday a government report will be de-classified explaining all this as it was in the case of another free-energy machine, that being the Hans Coler device, which was declassified by the British in 1978 (25) and which worked, according to Mr. Watson, using the same principles of cold magnetism. Until that final reckoning comes aspects of the Schappeller device will still remain a mystery. And until a more final reckoning comes, the question of if the Schappeller device was used as a source of field propulsion in German flying saucers must be deferred.

## The Karl Schappeller Device

### Sources and References

1. Bahn, Peter, Ph.D. and Heiner Gehring, 1997, pages 120-131, Per Vril-Mythos Eine geheimnisvolle Energieform in Esoterik, Technik und Therapie, Omega Verlag, Duesseldorf
2. 2. Taeufer, Johannes, 1930, page 31. "Vril" Die Kosmische Urkraft Wiedergeburt von Atlantis, commissioned and distributed by the Reichsarbeitsgemeinschaft "Das kommendende Deutschland", Astrologischer Verlag Wilhelm Becker, Berlin-steglitz
3. Bahn/Gehring, 1997, page 131
4. ibid, pages 120-124, 130
5. Weltdynamismus Streifzuege durch technisches Neuland an Hand von biooaischen SYmbolen, 1930. pages 14-15, commissioned and distributed by the Reichsarbeitsgemeinschaft "Das kommendende Deutschland", Otto Wilhelm Barth Verlag, Berlin
6. Davson, Cyril W., 1955, pages 50-59, The Physics Of The Primary State Of Matter And Application Through the Primary Technique, Elverton Books, London
7. Nieper, Hans A., Ph.D., 1985, Conversion of Gravity Field Energy/Revolution in Technology. Medicine and Society. M.I.T. Management Interessengemeinschaft fuer Tachyonen-Geld-Energy GmbH, Friedrlch-Rueder-Strasse 1, 2900 Oldenburg, Germany (available in German and English language versions)
8. Davson, Cyril W., 1955, pages 212-213
9. ibid, page 231
10. ibid, pages 217, 223
11. Taeufer, 1930, pages 30-32
12. Davson, 1955, page 230
13. ibid, page 226
14. Taeufer, 1930, page 30
15. ibid, page 32
16. Davson, 1955, page 231
17. ibid, page 231
18. ibid, page 57
19. Taeufer, 1930, pages 38-40
20. Clark, Richard LeFors, Ph.D., 1987, page 64, "The Earth Grid, Human Levitation And Gravity Anomalies", contained in Anti-Gravity And The World Grid edited by David Hatcher Childress, Adventures Unlimited Press, Stelle, Illinois

21. ibid
22. ibid
23. Stevens, Henry, 2001, "Infinite Energy", pages 9-13, Volume 7, Issue 40
24. Davson, 1955, page 244
25. Bahn/Gehring, 1997, page 115
26. British Intelligence Objectives Sub-Committee Final Report Number 1043, item number 31, "The Invention Of Hans Coler, Relating To An Alleged New Source Of Power, Bryanston Square, London

[Chapter Index](#)

[Main Index](#)

## Chapter 4 Summary

There is ample evidence that the Schauberger saucer model flew. The fact that the Schaubergers were brought to the United States to continue the work leads to the assessment that they worked on something of value to the government of the United States. The U.S. government was neither interested in his water research nor was it interested in his work on agriculture. We are left to conclude that it was his work on a new form of levitation, his saucer work, which brought Viktor Schauberger and his son Walter Schauberger to the United States. After learning all they could, the government of the United States dismissed the Schaubergers rather badly, foreshadowing the treatment of the German rocket scientists two decades later.

Lionel Shapiro was a credible and incredibly well connected reporter of the war and post-war years. The fact that he was able to break stories relating to secret weaponry in Czechoslovakia indicates that he had some connections within the U.S. military. With the war won, the years of 1946 and 1947 seem to have been a period when the guard of censorship was relaxed. This noose would be re-tightened as the cold war got underway. No fault can be found with Mr. Shapiro's article or its content. The article on the KM-2 electromagnetic rocket and Mr. Shapiro's other stories appeared in respectable newspapers, not tabloids. His post-war report of the KM-2 electromagnetic rocket must be taken on face value as legitimate.

The German eyewitness account of "Magnetscheibe" prompted investigation into U.S. governmental sources for corroboration. The CIOS report and the F.B.I. report provided corroboration. In the CIOS report we find a U.S. governmental admission of experiments in field propulsion for aircraft undertaken in wartime Germany by Dr. Erb. The F.B.I. report on a field propulsion German saucer must be taken seriously because the F.B.I. took it seriously. The F.B.I. carefully took the report and investigated the veracity of their subject. The F.B.I. then sent copies of this report to other intelligence agencies within the U.S. government which is indicated on the F.B.I. report itself. The Bureau saved the report all these years. The fact that this report deals with German technology but was taken by a domestic law enforcement agency, one whose "spy" activities are geographically restricted to within the USA, is noteworthy. It may indicate that the F.B.I.'s Director, J. Edgar Hoover, was kept "in the dark" about the real nature of flying saucers and may have wanted to show the other intelligence agencies that he was not so easily cut out of the information loop.

If you do not believe this F.B.I. report does not constitute something special, ask yourself, if you had walked into an F.B.I. office and described a UFO sighting you had made over ten years previously, what do you suppose the Bureau's reaction would be? Would you be taken seriously? Would your background be investigated and would your story be the subject of such extensive treatment? Would your report be kept for forty years? Or, on the other hand, would you be politely shown the door by a condescending uniformed security officer. Something in this report really struck a nerve at the F.B.I.

There is some suggestion that the Germans worked on a chemical engine which produced levitation. There is a possibility that electricity was produced by the Germans directly from atomic energy. There is some evidence, from both German and English language sources, that the Karl Schappeller device was being developed within Germany during the period of time in question. There is evidence that both the Schauberger and the Schappeller devices can be explained in terms of implosion and that implosion may have yielded the levitation force behind field propulsion vehicles. There is ample evidence that the Germans had access to the ideas of Nikola Tesla. The work of Tesla may be seen as an alternative method of propulsion or as a method of moving a field propulsion vehicle after it was made weightless by another method. There are wartime pictures along with many very similar post-war pictures which indicate that the development of field propulsion vehicles took place at this time.

Concerning these pictures and related reports of flying saucers one is thrust up against the intelligence services of the government of the United States of America who see fit to involve themselves. As we will see, it is the latter's rather clumsy attempt to suppress and discredit the flying saucer phenomena which actually speaks volumes for its existence.

The exact methods pertaining to the propulsion of these saucers may be plausible but they can only be taken as provisional at this time. There may be hundreds of ways to power a field propulsion saucer. The question is not "how could it have been done" but "how was it done".



The brilliant Austrian scientist Victor Schauberger.

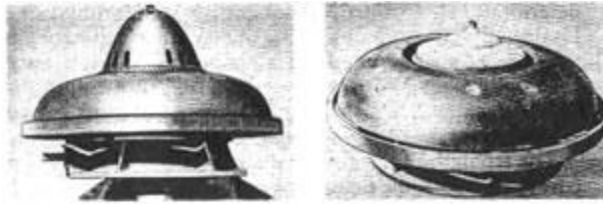

Victor Schauberger's vortex saucer models. Left: Victor Schauberger with a model of a home generator.

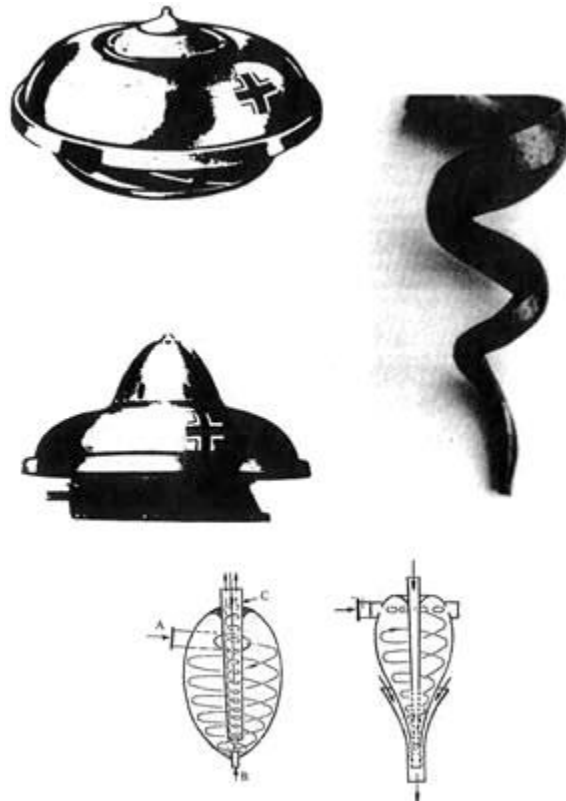

Above: Victor Schauberger's vortex saucer models, inspired by a kudu horn from Southern Africa. Below: Schauberger's two variations of an accelerator for nuclear fusion.



Above: One of a series of three photos taken by postman M. Muyltermans near Namur, Belgium, at about 7:30 PM on June 5, 1955. Project Blue Book showed little interest in these clear, daylight photos, despite the fame that they achieved.



Above: A cylindrical-appearing UFO photographed over Torrance, California in 1967. Possibly part of the southern California testing of US military modifications of German designs?

Dec. 14, 1971

Filed Nov. 4, 1968

H. W. WALLACE  
METHOD AND APPARATUS FOR GENERATING A SECONDARY  
GRAVITATIONAL FORCE FIELD

3,626,605

6 Sheets-Sheet 5

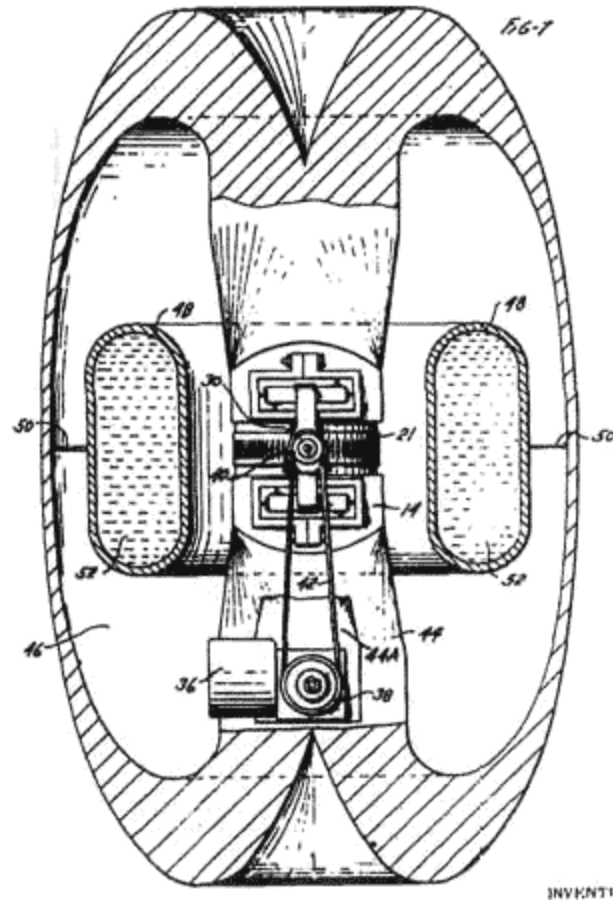

Above: A 1968 patent granted to H. W. Wallace for a "method and apparatus for generating a secondary gravitational force field," exactly the kind of engine that the Germans were allegedly developing during WWII.

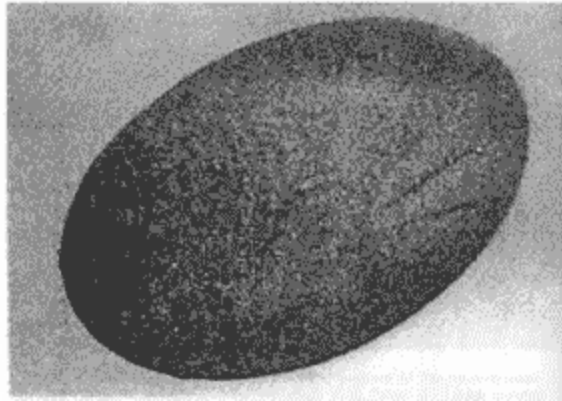
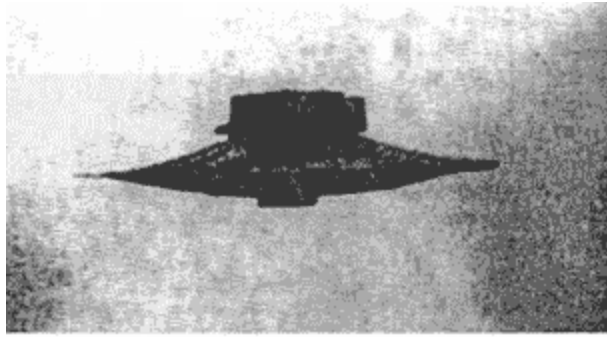





## [Chapter 4 Index](#)

## [Main Index](#)

### CHAPTER FIVE:

## LORE AND LOOSE ENDS: A DISCUSSION OF GERMAN SAUCERS

Some of the historical context for German flying discs has been discussed in the preliminary section of this presentation, "The Situation Within Nazi Germany". German saucers were not designed to generate the flying saucer mystery in the second half of the Twentieth Century. They were designed as a weapons system to do a specific job. The fast-moving wartime mind-set was a time when new aircraft designs and new propulsion technologies were coming on line with increasing frequency. The insertion of these saucer-craft into the wartime fabric did not seem as culture altering as the disclosure of these same craft might be to us today. But a simple recitation of the facts is not enough. Some things need to be said about the ideas on German saucers in order to put their study in a better context. Also, some strings have been left untied and some ideas need to be mentioned in order to round out the discussion on this topic.

No better place to start exists than with Renato Vesco. Vesco's insights for the reasons for German saucers were right on the money as were his descriptions of cultural conditions within wartime Germany which prompted this response. Vesco elucidated the foo fighter mystery as nobody else did. But he went on to describe another mystery craft which he called the "Kugelblitz" or "ball lightning" in English (1). This craft is not the same as the Schriever, Habermohl, Miethe or any other saucer design so far disclosed. Indeed, Vesco seems to know nothing of these other projects. His only descriptions were of the Feuerball (foo fighter) and the Kugelblitz.

Vesco described Kugelblitz as the big brother of the Feuerball, meaning that it was a further development of the Feuerball or foo fighter. A central cupola or cabin was surrounded by a free-spinning body or saucer which was turbine driven. Further stabilization was probably provided by a small but rapidly spinning centrally positioned flywheel, a gyroscope, set at ninety degrees from the axis of the saucer. The Kugelblitz was able to take-off vertically. Its method of destroying enemy aircraft was probably that described by Vesco (2) and confirmed in new U.S. government documents which included the description of the "Phoo Bomb" (3) under item six, "Gases Applicable To Aircraft". In this system the Kugelblitz approached an enemy bomber formation and ejected one of two types of gas ahead of that formation. The engines of the bombers inhaled the gas and were either destroyed by pre-ignition or engine seizure caused by loss of motor oil viscosity. It is not known if one or both methods were used.

The Kugelblitz was guided to the bomber formation by a homing device whose name may have caused Vesco and later UFO researchers some confusion. This is because there existed a homing device whose name was "Kugelblitz". This may have caused Vesco to assume the entire project bore its name. This device was manufactured by the Patent Verwertungs Gesellschaft of Salzburg and we know quite a bit about it through a Freedom Of Information Act response (4).

Curiously enough, and for a second time, the file comes to us from the Federal Bureau of Investigation, a domestic spy agency which theoretically had no business investigating foreign technology in foreign lands.

The Kugelblitz homing device was a proximity fuse which measured radio frequency waves bounced back from the target, reconciling the Doppler shift with measurement of standing waves to find the exact distance to the target. This homing device was the best of any produced by the Germans, according to the report, as was to be used on all varieties of flak rockets including the Schmettlerling and the Rheintochter. Examples were built at the Patent Verwertungs Gesellschaft plant but it never reached full assembly line production.

There are two interesting asides to this story. The first is that on May 1, 1945, one day after Hitler shot himself in the bunker and six days before Germany surrendered, two officers of the Reichsministerium fuer Rüstungs und Kriegsproduktion (Albert Speer's ministry) arrived at the plant and took all existing examples of the Kugelblitz devices and the plans. Neither the two officers, the devices, nor the plans were ever seen again (5). Why was this done? Realistically, these officers must have had some post-war aspirations for this device. It must be added that at this point in the war, Speer's ministry, the Reichs Ministry for Armament and War Production referred to above was in fact being administered and run by the SS.

The second aside is another device in the conceptual stages at the Patent Verwertungs Gesellschaft called "Phantoscope". Phantoscope was to employ high frequency waves beamed to the ground then reflected and picked up on

board a moving aircraft to image, in three dimensions, the contours of the earth's surface using a glass case filled with gas and tiny vertical wires. This could be done in any weather, day or night (6). One wonders if the German officers plucked this jewel also? If so, was this to be used on a manned saucer?

Vesco says the Kugelblitz saucer was flown once against enemy aircraft (7). It was destroyed by technical detachments of the SS after "a single lucky wartime mission" (8) in late March or April of 1945 (9) .

Another mystery is the post-war activities of Dr. Richard Miethe. Most all sources state that Dr. Miethe went to Canada after the war and worked on a joint Canadian-American saucer project at an aircraft facility near Toronto, Ontario. Unfortunately, all Freedom Of Information Act inquiries concerning Dr. Miethe run into the solid wall of "no record". Only one researcher ever claimed to have a document naming Dr. Miethe in association with this Avro Aircraft, Limited project, (also known as A.V. Roe, Limited), and that one researcher later admitted to being "a government asset" which throws a cloud of doubt on all his work(10).

There is no doubt, however, that by early 1955, work was commenced by Avro to build a mach 3 flying saucer which is reminiscent of some of the designs attributed to Dr. Miethe. Two designs were proposed, the difference being the engine used to power the saucer. One proposal was to use several axial-flow jet engines. The second and preferred proposal was to use one large radial-flow jet engine. The axial type is the type most commonly used in jet aircraft today. The radial type was similar to the first jet engine flown by the Germans in 1937. In fact, the radial engine actually under study in Canada may have had some similarities with the Rene Leduc engine used by Dr. Miethe.

Work continued until the early 1960s under various names including Project Silver Bug and Project 1794. Finally, a small hover-craft was unveiled by Avro as the final outcome of their saucer experimentation. This "Avrocar" had nothing to do with either Dr. Miethe's work or a mach three interceptor. The Avrocar was probably a cover project for something else. This "something else" was more advanced.

The Avro Aircraft, Limited experimentation with saucer-craft was always an open secret which was at times exploited by the government. Information regarding this project has been obtained via Freedom Of Information Act using their American partner, the United States Air Force at Wright-Patterson Air Force Base, by this researcher as well as other researchers.

There exists a sub-story to the Canadian involvement which should be mentioned. In an article in a British UFO magazine, writer Palmiro Campagna revealed a previously unknown connection between the Canadian government and the history of German saucers (11). It seems that an SS technical liaison officer, Count Rudolf von Meerscheidt-Huellessem, (erroneously spelled "Hullessem" in the article), contacted the Canadian government in March of 1952, offering technical information about a German saucer which could attain speeds "limited only by the strength of the metals used in the saucer's construction". According to the article, von Meerscheidt-Huellessem wanted a large sum of money as down payment, a monthly salary and Canadian citizenship and police protection in exchange. Support for this claim comes in the form of copies of Canadian government documents describing this offer. Mr. Campagna states in the article that the Canadian government ultimately declined the offer but that the American government may have taken over negotiations and accepted.

## **Avro Flying Saucer**

## AVRO FLYING SAUCER: SECTIONAL DIAGRAM

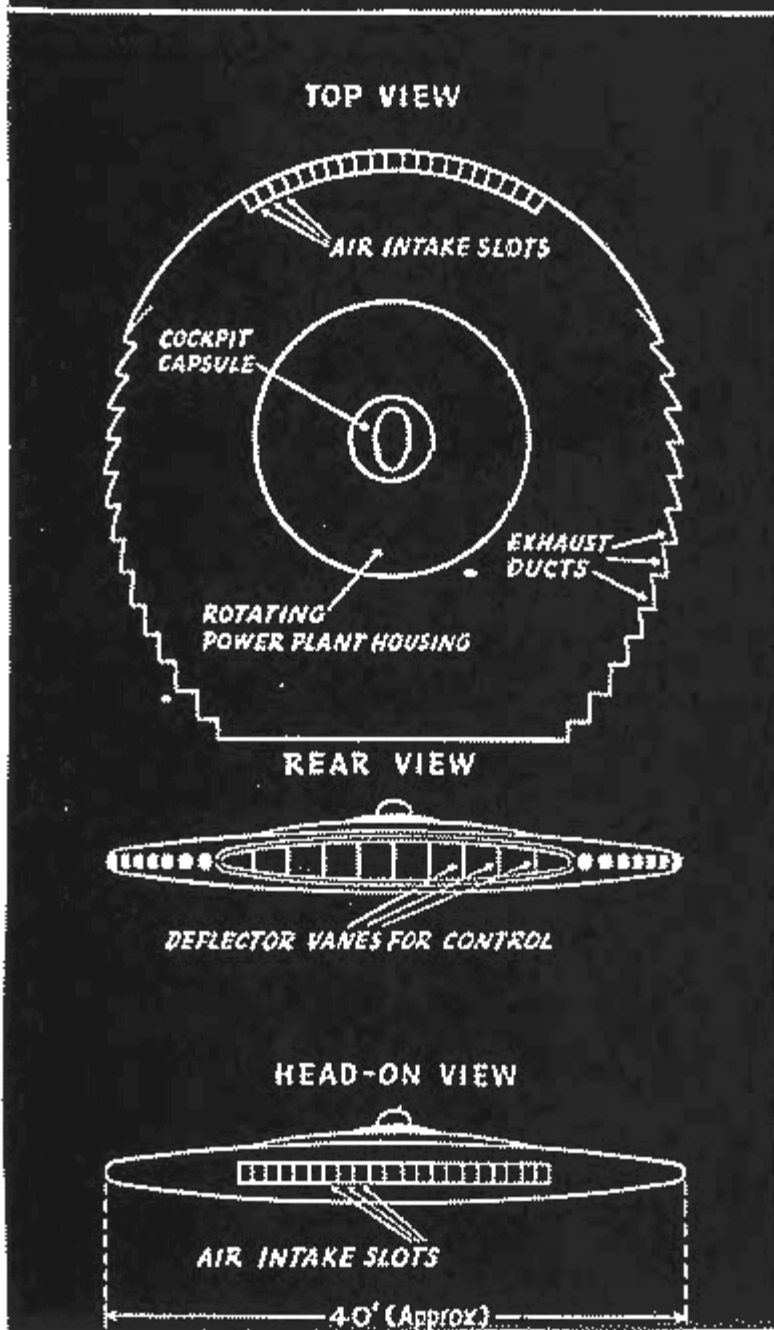

This is a general diagram of the exterior of an Avrosaucer. It is representative of how the Avro radial engine saucers worked. Within this outer hull an inner, flatradial-type engine of was situated. This is exactly the scheme designed by Dr. Richard Miethe it and has been copied from his designs. Dr. Frost and his engine designs were overblown, heavy, complicated frauds.

Contact was made by this researcher with a daughter of Count Rudolf von Meerscheidt-Huellessem's who verified that her father was a technical liaison officer. She had little contact with her father since she was two years old since he had remarried and moved to Canada. She was able, however, to provide the address of another relative, Countess von Huellessem, who was Count Rudolf von Meerscheidt-Huellessem's widow.

Contact was made with Countess von Huellessem. Count von Meerscheidt-Huellessem died in 1988. But the Countess did know a little something about the story in question. Her late husband did discuss the flying saucer with her but only once. He told her that the "drawings" had been given to a representative of the Canadian government in 1952. After review of the drawings, the only comment from the representative was that they were "outdated". The drawings were never returned. The Canadians had succeeded in obtaining hard information concerning a real flying saucer and in paying

for it with an insult. Count von Meerscheidt-Huellessem was somewhat despondent over the rejection. He never mentioned the subject to his wife again. At the time they were both making new lives for themselves in Canada and the subject never resurfaced.

In discussing these events with the Countess over the telephone, she told me that she herself had seen these drawings. She was asked if these were drawings or technical plans. She said they were technical drawings on rolls of paper. I said the word "blueprint" and she said "yes". She stated again that these drawings were given only to the Canadians and not to the Americans.

Countess von Huellessem was sent a copy of the aforementioned article. Her only comment was that her husband would not have asked for a large sum of money in exchange for this information. They already had means. He might have asked for a position, she said, since her husband would have enjoyed working on this project.

Returning to the Avro Aircraft, Limited - U. S. Air Force saucer project, we have to ask ourselves some questions. First, was this information, these plans, the real basis of the Avro saucer project? This would certainly explain the reason for the partnership between the two governments involved since the Americans would have needed the Canadians at that point and the Canadians would have insisted upon control of the project on their home soil. Second, did the technology brought to the Canadians by von Meerscheidt-Huellessem have anything to do with the jet technology obtained under Freedom Of Information Act? It certainly had nothing to do with a hover-craft which was the outcome of this project according to the government. How could a floppy hover-craft barely capable of 300 miles per hour under the best of estimates have had anything to do with a saucer whose speed was "only limited by the strength of metals used in the saucer's construction"? Could Project Silver Bug, Project 1794, and some of the other patents of John Frost attributed to this collaboration all be nothing more than an elaborate cover story?

Another point is that until recently, the only connection linking the German saucer projects to the Avro Project and to the Americans was the involvement of Dr. Richard Mieth. With the new evidence of the Peenemuende Project's connection to the American saucer projects run out of Wright Field, Ohio and the Count von Meerscheidt-Huellessem connections to the Canadians, the weak linkage of Dr. Mieth to these projects is superfluous. There is now more than enough evidence to make these connections with or without Dr. Mieth. Further, considering the Count von Meerscheidt-Huellessem evidence, there is now a direct link between German saucer technology and the Canadian government's saucer project at A.V., Roe Limited. That link turns out to be the SS in the form of an SS technical liaison officer.

There are differing opinions as to how known saucer-types were actually powered. Every researcher seems to have his own ideas about this subject. Could the answer to this dilemma be that there are more types of German saucers than we know about? For instance a device is depicted in a 1975 issue of Luftfahrt International, a well respected German aeronautical magazine, which shows a drawing of a "Flakmine" (12). Depicted are several rotor blades, some powered by ram-jets, making it essentially a jet-powered helicopter. This device may have been derived from design work done in Italy in which the propellant and the explosive were the same substance. This device was called the "Turboproietto" meaning in English, "turbine projectile" (13). It would have been able to carry large quantities of explosive to the altitude of a bomber formation. The device would have rotated up, vertically, to the level of a formation of bombers and then detonated, using the remaining fuel as a bomb, presumably inflicting heavy losses. Klaus-Peter Rothkugel refers to this very device as a "Drehfluegel" and will detail its development in his upcoming book.

In another instance of a possible saucer type, saucers shown to Bill Lyne in a movie clip while he was in Air Force Intelligence were described by him as "flying turtles" (14). This film was taken by B-17 flight personnel during World War Two as the two German saucers attacked a squadron of bombers. Other writers including Michael X. Barton and Norbert Juergen-Ratthofer used these same descriptive words. Vesco describes the "Feuerball", the fire fighter, as "circular and armored, more or less resembling the shell of a tortoise". This description also applies to his Kugelblitz (15). Turtle or tortoise is "Schildkroete" in German. Sometimes this device is referred to as a "flying turtle" in both languages. With so many writers using this term for flying craft which are apparently not all similar, there exists a certain amount of confusion about this name, "Schildkroete". Therefore, this saucer does not seem to fit neatly into any previously described saucer type. Perhaps this flying turtle is only another name for the Fireball or fire fighter which seems to be the consensus among German writers, other writers seem to associate this word with a larger craft so perhaps this type of saucer is closer to what Vesco described as the Kugelblitz. "Schildkroete" seemed so nebulous that for many years this writer refused to accept the term at all.

This all changed when it was uncovered that the Germans were actually developing a flying weapon code-named Schildkroete. This researcher as well as other researchers have found references to an offensive air weapon, called by the Germans, "Schildkroete", and known to American intelligence. The exact nature of this device is, however, still kept secret. The government is uncooperative, even when presented with their own words on the subject and copies of their own reports. For instance in a Combined Intelligence Objectives Sub-Committee interrogation of Albert Speer, Reich

minister of Armaments And War Production, report 53(b), Speer is specifically asked about "Schildkroete". Only Speer's reply is retained in the record, not the actual question. Line number 20 of that interrogation quoted here as the document from microfilm is difficult to read:

" 20. Schildkroete he was not sure about, but he thought it might, conceivably be a jet fighter. "

By the time Schildkroete had come about, Speer had lost much of his standing and duties to officials of the SS. In this same set of interrogations Speer deferred a question concerning V-weapons to Dr. Hans Kammler as the one the Allies should seek as the expert. Speer was the only one raising Kammler's name. There was no follow-up questioning by the Allied interrogators. It was almost as if Speer had uttered an obscenity, invoking the "K" word, which was a word simply too hot to be touched in that setting.

The next Allied reference to Schildkroete comes from the Combined Intelligence Objectives Sub-Committee, Evaluation Report 40, titled "Sonderausschus A-4". Sonderausschus was an organization whose job it was to prioritize resources toward projects most needed to defend the Reich. These high priority programs were the Vierjahresplan, Vulkanprogramm, Jaegerprogramm, Lokprogramm, and the Notprogramm. Each had projects within these headings. Even though under pressure of law in the form of a request under the auspices of the Freedom Of Information Act, the Federal Government of the United States of America has responded with a "No Record" when asked for their files on some of these programs. This is true even when confronted with their own documents naming these programs. One project, project 8-162, clearly names Schildkroete as the code-name of this project. It is listed in association with a known project, the "Salamander" project, which resulted in the He 162A Salamander or Volksjaeger jet fighter.

U.S. Government Documents Mentioning "Schildkroete"

## Production and Layout

The Mittelwerk and Nordwerk tunnel system had been in reasonable full production up to the cessation of hostilities, the main production being:-

V1 and V2 components and assembly  
Taifun - flak rocket components  
Schildkroete - flak rocket components  
Junkers Engines - Junk 004 components and assembly  
Junk 213 components and assembly

SECRET XO-13489

5. Arbeitsausschuss Kontingente under Dir. Russo was charged with cooperating with the various plants throughout Germany to insure that required raw materials were received at the proper times and places. Interrogation of Russo revealed that he had been instrumental in and/or had certain knowledge regarding the following programs:

<u>Name or Designation</u>	<u>Remarks</u>
Vierjahresplan 4 years plan	
Vulkanprogramm	
Jägerprogramm	
Lokprogramm	
Notprogramm	Necessity program
S-103	V-1. Also known under code name "Kirschkern" or "cherry pit" and as "VU I". Sometimes known also as "Libelle". Was manufactured or was to be manufactured by Henschel, Schnefeld/Berlin. Final assembly in Mittelwerke at Heidersachsverfen.
S-117	Also known as No. 117 and "Schmetterlin" or "Butterfly".
S-152	
S-162	also known as "Schildkröte" and "Salomander". Manufactured by Heinkel in Rostock, Junkers in Dessau; motors from Mittelwerke in Heidersachsverfen, Baysische Motorenwerke in Eisenach, Berlin-Spandau and Zuhlsdorf-Wendnitz/Werk, Klöckner in Brünn and Walter-Motoren in Prag.
S-246	

19. Mistel, he had explained yesterday as being pick-a-back aircraft.

20. Schildkröte he was not sure about, but he thought it might conceivably be a jet fighter.

21. Taifun and Tbar he had not heard of.

Top: Combined Intelligence Objectives Subcommittee (CIOS) Report items 21, 22, 31, File# XXX111-38 Underground Factories In Germany, page 19. Middle: CIOS Report 40, Sonderausschus A-4, page 5. Bottom: CIOS Report 59(b) Interrogation Of Albert Speer Reich Minister Of Armaments And War, Page 3

The last reference to Schildkroete was found by Heiner Gehring in the Combined Intelligence Objectives Sub-Committee Party 536 report on Underground Factories in Germany. This was classified as "Secret" and was a G-2 Division, S.H.A.E.F. report! In describing the large underground facility at Nordhausen, where the bulk of the V-2 production took place, tunnel divisions Mittelwerk and Nordwerk were said in this secret report to be producing "Schildhroete - flak rocket components". Although spelled incorrectly in the report, the intended word is very apparent.

Clearly something is going on under the heading Schildkroete. A possibly is the connection of Schildkroete to the Italian "Turboproietti" mentioned by Vesco. In an information sheet, Klaus-Peter Rothkugel depicts a diagram for the Turboproietti. This design is remarkably similar that found in Swiss newspaper from the mid-1950s (16). This article credits the successful German saucer program and Georg Klein and goes on to describe another related design which is reproduced here. One can immediately see the relationship with the Turboproietti design. In this design the center of gravity is below the saucer surface adding stability. The pilot's cabin is also below the wing surface. This is curiously similar to a turtle's bony structure in which the head and neck emerge from under the turtle's shell. Could this have been the Schildkroete design?

This design calls for the use of ram-jets but turbojets could have also been used. Fuel tanks are located in the rotating wing and so fuel is fed to the jet engines by centrifugal force. The two small wings have adjustable angles as do the jet engines themselves. Thus, the method of vertical flight is similar to the Schriever-Habermohl saucers.

The horizontal maneuvering is unique and warrants discussion. We have all heard reports of flying saucers in flight making seemingly non-aerodynamic turns instantaneously. In this article, Mr. Zollikofer proposes a simple method to accomplish this. It involves angular momentum. We all remember seeing a child's top spinning on a smooth floor. Perhaps the reader will recall that when the top nears a piece of furniture and hits it, the top shoots off instantly in the opposite direction. This happens because contact with the furniture caused a change in the top's angular momentum. The top's momentum was braked on one side. A sudden slow down on one side caused an imbalance whose force drove the top to the opposite direction.

In this same way the intentional slowing of one engine (on one side) on this saucer design would cause the rapidly spinning saucer to instantaneously change course, shooting to the other side. Several of these course changes would resemble insect-like flight to the observer. The rapidity of the course changes is tied to the degree of slow-down or breaking of the saucer's angular momentum and to the degree (revolutions per minute) of that momentum. Even when stationary, increased spinning would serve as a "bank" of angular momentum to be drawn upon at a moment's notice.

#### "Turbopriette" And A Possible Successor

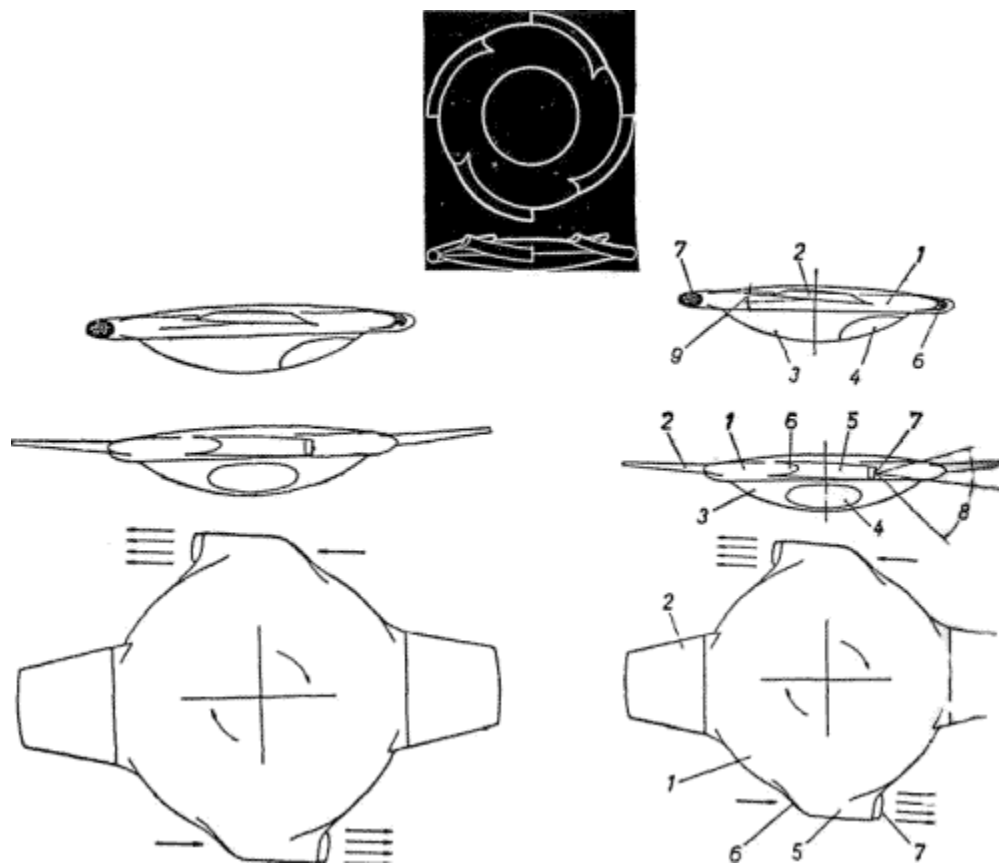

Top: Italian designed "Turboproietti" an anti-aircraft design which used left-over fuel as its warhead. Bottom: Saucer design, 2/3/55, "Neue Zuercher Zeitung". 1. Hub of the rotating winged-wheel. 2. Adjustable wings 3. Non-rotating cabin.



4. Lookout for the pilots. 5. Ram-jets 6. Air intake. 7. Exhaust, direction changeable. 8. Angle of variation of the exhaust rudder. 9. Variable adjustment angle of the wings. Was this a Schildkroete? Kugelblitz?

Through out Vecso's Intercept UFO the words "circular wing" are mentioned. Looking at this design yields a possible new understanding to that term. It is possible that this basic design is to be found in the foo fighter, (Feuerball, Phoo Bomb),as well as the mysterious Kugelblitz. It was hinted above that this design may be the basis of the Schildkroete but it could also be the basis for other German saucer projects.

Many writer attribute field propulsion to the foo fighter. This is because of its luminosity, its flight pattern and its alleged disruption of ignition based aircraft engines. Another possibility is that it was a jet propelled flying machine but with one addition. It is possible that a T.T. Brown-type of flame-jet generator was attached to its exhaust nozzles and the appropriate insulation added on the surface of the craft. With this addition, the exhaust gasses would become enriched with negative ions. So would the air in the surrounding vicinity. This would have resulted in the short-circuiting of the target aircraft's engines should such variables as the wind have been just right. The fact that it apparently did not always work argues for the variables being in operation. More variables would have accompanied this means of disruption than a purely electromagnetic one since the electromagnetic field would have been present regardless of atmospheric conditions. In other words, the field propulsion vehicle should have always disrupted the bomber's engines.

Another item is submitted for your consideration under the heading of "loose ends". This is another F.B.I. report, Number 62-0-11328, which is reproduced here in total. A unique feature of this report is that it contains two "xerox" copies of a German saucer. These pictures were given to the F.B.I. but the negatives were retained by the informant whose name has been deleted. Also deleted is the last name of the German saucer designer. It is a remotely controlled device but the circular glass cockpit indicates a design ultimately intended for human pilots. Undulations on the saucer periphery resembling jet engines are noticeable in the picture. This report dates from July 8, 1967 but describes events from November, 1944. As with the other F.B.I. report, the fact that it was taken and kept so long attests to its worth.

There are some similarities between this report and Vecso's description of the Kugelblitz. The encounter described in the F.B.I. report resulting in the "downing" of a B-26. Vecso describes the same or a similar incident involving the Kugelblitz and an American "Liberator" (17). Both saucers are surprisingly identical in description. In the F.B.I. report this secret project was set in the "Black Forest of Austria". The Schwarzwald, the Black Forest, is in Southern Germany. Vecso says that toward the end of the war the Germans dispersed their remaining aircraft to improved air field hidden in thick pine forests (18).

A Second F.B.I. Report on German Flying Discs(Three pages and best possible picture)

# Memorandum

*97/8*  
*14/8/67*

TO : DIRECTOR, FBI

FROM : SAC, MIAMI (62-0-11328)

SUBJECT: [REDACTED]  
INFORMATION CONCERNING

DATE: 6/8/67

*11468 518885*

A review of the Miami indices revealed information reflecting subject appeared at the Miami Office on July 24, 1959, and volunteered to return to Austria as an intelligence agent. His expressed motivation was to do something to repay the debt he felt he owed the United States. He was afforded the Washington, D. C. Headquarters address of the Central Intelligence Agency and told his inquiry should be directed there.

Also, on July 4, 1961, he appeared at the Miami Office and gave an incoherent story of recently meeting an individual who asked him to kill his mother. [REDACTED] appeared to be somewhat bewildered and continuously gazed away from the interviewing Agent.

During his most recent visit to the Miami Office, [REDACTED] seemed genuinely concerned about the existence of the object he allegedly photographed during November, 1944. He exhibited no emotional nor mental disorder and appeared to be rational.

In view of recent publicity afforded UFO sightings, some apparently by responsible sources, this information is submitted to the Bureau for consideration of transmittal to the U. S. Air Force.

*1 cc Enclosure  
sent to CIA by formal 11/27/67*

REC-40

*65-23974-460*

14 JUN 12 1967

1 - Bureau (Enc. 4)  
1 - Miami  
LB/bab  
(3)



JUN 27 1967



UNITED STATES DEPARTMENT OF JUSTICE

FEDERAL BUREAU OF INVESTIGATION

In Reply, Please Refer to  
File No. 62-0-11328

Miami, Florida  
June 8, 1967

RE: [REDACTED]  
INFORMATION CONCERNING

*Lead Army 3, 192 of 111 40*

On April 26, 1957, [REDACTED] Miami, Florida, appeared at the Miami Office and furnished the following information relating to an object, presently referred to as an unidentified flying object, he allegedly photographed during November, 1944:

Sometime during 1943, he graduated from the German Air Academy and was assigned as a member of the Luftwaffe on the Russian Front. Near the end of 1944, he was released from this duty and was assigned as a test pilot to a top secret project in the Black Forest of Austria. During this period he observed the aircraft described above. It was saucer shaped, about twenty-one feet in diameter, radio controlled, and mounted several jet engines around the exterior portion of the craft. He further described the exterior portion as revolving around the dome in the center which remained stationary. It was [REDACTED] responsibility to photograph the object while in flight. He asserted he was able to retain a negative of a photograph he made at 7,000 meters (20,000 feet). A Xerox copy of the negative, as furnished by [REDACTED], appears on the last page of this communication. Also, a still photograph he allegedly made "at the risk of my life", illustrating the object parked in a hanger, appears on the last page.

According to [REDACTED] the above aircraft was designed and engineered by (First Name Unknown) [REDACTED] a German engineer whose present whereabouts is unknown to him. He assumed [REDACTED] was taken into custody by Allied Forces upon the termination of hostilities. [REDACTED] stated [REDACTED] unsuccessfully attempted to avoid the German draft, but was apprehended by the Gestapo

INDEXED

62-0-11328-411

RE: [REDACTED]  
INFORMATION CONCERNING

[REDACTED] in Vienna, Austria, sometime during late 1943 or early 1944. [REDACTED] also assumed the secrets pertaining to this aircraft were captured by Allied Forces. He said this type of aircraft was responsible for the downing of at least one American B-26 airplane. He furnished the following fuel and engine data:

"....Fuel mixture of  $N_2H_4O$  in Methyl Alcohol ( $CH_3OH$ ) rather than 'oxygen-holding' mixture of hydrogen peroxide  $H_2O_2$  in water. 7m 1,3m high two rocket motors; smooth flow, rotary drive over 2,000 meters per second...."

[REDACTED] said he copied this data from a board located in the hanger area.

[REDACTED] asserted he was shot down by the British on March 14, 1945, after having been reassigned to the Western Front. He was held prisoner by the British in London and later in Brussels until his release in 1946. He departed for the United States from Bremerhaven, Germany, on December 26, 1951; entering the United States in New Jersey on January 7, 1952, and was subsequently naturalized in Miami during 1958. He is presently employed as a mechanic at Eastern Airlines, Miami, Florida. He related he was born May 3, 1924, in Austria.

[REDACTED] stated he has withheld this information because he assumed the United States possessed it. He has become increasingly concerned because of the unconfirmed reports concerning a similar object and denials the United States has such an aircraft. He feels such a weapon would be beneficial in Vietnam and would prevent the further loss of American lives which was his paramount purpose in contacting the Federal Bureau of Investigation (FBI).

[REDACTED] reiterated he has the original negatives of both photographs. He said the shots were taken at a thirty second time exposure.

This document contains neither recommendations nor conclusions of the FBI. It is the property of the FBI and is loaned to your agency; it and its contents are not to be distributed outside your agency.

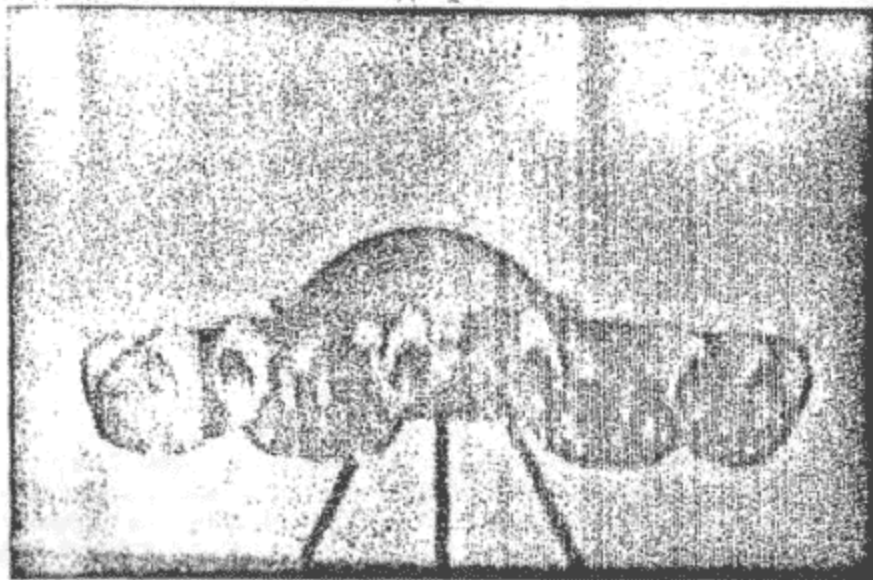

Vesco specifically mentions the Schwaebischerwald and the Bubesheimerwald (19). Vesco goes on to say:

"It was from one of these improved fields that the first Kugelblitz fighter took off on its fantastic flight" (20).

The general description of the airfield hidden in a forest does seem to correspond with what Vesco described. Finally, the fuel used on this saucer was unlike that of the Me-163 or any other fuel known. Is this a variant of the exotic fuels Vesco says were considered for German saucers? (21).

Is this report confirmation of Vesco? Is the informant in the F.B.I. report describing a Kugelblitz? Is this fuzzy "xerox" copy really a picture of the Kugelblitz? It is not proof positive, but it is intriguing.

A request was made to the F.B.I. for a clear picture. The Bureau responded on March 22, 2001 saying that the Miami Field Office may have had a clearer picture but that the file was destroyed.

Here we have a real X-File, yet nobody saved the picture? Fox Mulder, where are you when we need you most? The F.B.I. did provide a somewhat clearer picture which is reproduced here.

Sometimes blind luck is needed when dealing with the government. This has proven to be the case regarding a very special compass developed by the Germans to use in their flying disc program. Actually, there may have been more than one type of compass for this purpose. The first inkling of this compass comes to us from the writings of Wilhelm Landig wherein he describes a "Himmelskompass" or heavenly compass (22). This device was mounted upon a flying disc and could orient itself using the position of the sun even in twilight or if the sun was below the horizon. The method given for its operation is that sunlight striking the earth is polarized and that this direction has a stronger electromagnetic field which can be detected with instruments (ibid). The magnetic fields emanating from the north and south poles are a similar situation.

**William Lyne** discloses, pictures and describes a German compass which he states was used on a German flying disc in his book [Pentagon Aliens](#), the first edition which circa 1990. He bought the device as junk from a New Mexican junk dealer who got it on an Air Force base after it had apparently slipped through a security check.

"Mother Horizon"

(e) Artificial horizon

A self regulating artificial horizon for use in aircraft was invented by Dr. Knappstein, who had a factory in Berlin-Schoneberg. He worked in collaboration with Henschel, Berlin-Königswusterhausen. The horizon was not affected by any aerobatic manoeuvres.

PAGE NO. 2

NO.	TO	FROM	DATE
			1174 - RESTRICTED - 9 June 1945 Subject: "Mother Horizon"
			Request received from Technical Data for one (1) "Mother Horizon", as the Germans called it. It's a remote indicating gyro horizon device. Equipment Lab seems to be the interested agency.
			 D. L. FITT, Colonel, A.C. Director of Technical Services

"Mother Horizon" was possibly a device used on a German flying disc. Top: "Information Obtained From Targets Of Opportunity In The Sonthofen Area" BIOS Report # 142. Bottom: Entry in microfilm obtained via FOIA.

219 Recently, mention of a German compass was encountered while searching for something else in a Freedom Of Information Act response. Called a "Mother Horizon", the device recalls and may confirm the device first described by

Landig. On the other hand it may simply be a device showing the pilot the attitude of the aircraft in relation to that of the horizon. Whether or not this is the same device in the possession of William Lyne is not known at this time.

Turning to field propulsion saucers and pictures of them, it should be pointed out that the saucer pictures of Ralf Ettl and Norbert Juergen-Ratthofer are unique to them, that is, no pictures of saucers specifically identified as "Haunebu", "Vril" exist outside of their presentation to my knowledge. As if preempting criticism, these writers counter with the proposal that all Adamski saucers are really German field propulsion saucers or originated from German wartime designs. Adamski saucers were photographed and witnessed world-wide in the early 1950s. In fairness, it should be pointed out that there also exists at least one source of confirmation of their thesis.

Confirmation of sorts comes from a new book by a conspiracy writer, George Piccard, who cites similar information to that of Ettl and Juergen-Ratthofer as coming from his informant, a man calling himself "Kilder" (24). Piccard states that he believed the name "Kilder" to be an alias. Kilder was a clerk working in British intelligence and allegedly came to Piccard through mutual contact shortly before Kilder died of lung cancer. During his years of service, Kilder had allegedly filed away many classified documents which he committed to memory. This book is an interesting reading, of that there is no doubt. It is too bad though, that Piccard could not elicit the real name of the dying Kilder, because, as has already been pointed out, there is nothing reliable about an unnamed, secret government source and, hence, there is no reason to spill much ink in discussing the matter.

More evidence that the Germans produced something truly strange comes from the Polish researcher Igor Witkowski. Mr. Witkowski is considered by the Eastern European sources already cited, the engineer Mr. Robert Leiakiewicz and Dr. Milos Jesensky, to be the foremost authority on German saucers in Poland. This is no small title considering the mountains of research through which they have tunneled, both figuratively and in reality. According to his interviewer, Nick Cook, the Aviation Editor of "Jane's Defense Weekly", Mr. Witkowski was shown classified Russian documents through an unnamed contact. In them it described German research on a device called "die Glocke" (the bell). This device was tested underground, at Der Riese, at the Wenceslas mine near Ludwigsdorf (25) under the German code-names of "Laternentraeger" ("lantern carrier") and "Chronos" which obviously refers to time. This was done under the auspices of a heretofore unknown SS organization, the Forschungen, Entwicklungen und Patente (Research, Development and Patents) or FEP. This was Kammler's group according to Mr. Witkowski (26). Could this be the true name of what has been referred to up until now simply as the "Kammler Group"?

Mr. Witkowski maintains that this group was independent of the Reichsforschungsrat, the Reich Research Council, which is significant. Heading the research on the Bell was none other than Professor Walther Gerlach (27) who was among the very top tier of German nuclear scientists. A metallic liquid, violet in color and resembling mercury, was stored within the bell in two cylinders. These cylinders were spun in opposite directions for test lasting for a minute. The effects included a pale blue light emitted from the bell, electrical equipment failures, as well as deleterious effects on animals and people (28). To his credit, Mr. Witkowski did not try to make more out of this than is in evidence. He is of the opinion, however, that the bell was a very powerful engine (29). Of course, we all can jump ahead of the facts slightly and wonder if this engine was not to be used on a very large German atomic saucer or field propulsion saucer, the very kind described by Mr. Norbert Juergen-Ratthofer.

Weighing into the German field propulsion controversy is Dr. Axel Stoll. Dr. Stoll is a Geophysicist, that is, a real scientist. Dr. Stoll names no sources in his book but states that they exist and must be protected for the common good as opposed to that of serving an individual purpose as a citation (25). Dr. Stoll supports the assertion that field propulsion vehicles were being developed during the Third Reich. But unlike what has transpired before, Dr. Stoll gives us the theory and the mathematics behind the theory, citing and translating Maxwell and Bearden. Besides the mathematical support for his thesis that the Germans built field propulsion vehicles, he states something about his suspicion concerning a spin-off of this technology which may have been further developed by the Germans (26). It is what was stated by Mr. Juergen-Ratthofer over ten years ago in his video films.

It is what was indicated by circumstantial evidence at Jonastal and recognized as such for at least five years by some of the researchers there. It is that the Germans were interested in the manipulation of space and time itself. It is said that time and space can be manipulated or time and space can be created or obliterated through the use of an electromagnetic longitudinal wave (32). Normal electromagnetic waves, such as light waves, are transverse. This brings us right back to the production of quadropolar waves (transverse and longitudinal waves in cycle) as discussed in connection with the Schappeller device. Could this lost technology provide us with a window into time or into another dimension? Would our scientists of today be able to unlock this technology given their restricted scientific outlook? Has the reconstruction and piecing together of this puzzle occupied our scientists since the end of the Second World War?

Turning aside for a moment, as stated, this book was written as guide to German flying discs. As such, the reader should be cautioned about at least one pitfall. This pitfall consists of a series of technical diagrams of alleged German field propulsion

saucers, prominently displaying a date of November, 1944. In some of these drawings mention is made of a "Thule-Tachyonator". This word "Tachyonator" obviously has its origins in the word tachyon. This word bothered me for years but I loved those "old" drawings so much that my nagging doubts were put aside. What bothered me was the fact that this word never arose in my introductory physics course in the 1960s. This ate at me until I called the Physics Department at the University of California at Los Angeles for their opinion as to the origin of this word. An old physicist said from his memory the word was not even coined until the mid-1960s, thus casting doubt on the technical drawings. He gave me a reference and his memory proved correct. The word "tachyon" was coined by Dr. Gerald Feinberg in 1966 (33). This means that there was no word "Tachyonator" in 1944. Unless better evidence surfaces, the veracity of these documents must be questioned. It hurts to admit that I count myself as one of the people taken in by this deception.

## CHAPTER FIVE

### Lore And Loose Ends: A Discussion of German Saucers Sources

#### Sources and References

1. Vesco, Renato, 1976, page 158
2. Vesco, Renato, 1976, pages 137, 156-157
3. United States Strategic Air Forces In Europe, Office Of The Director Of Intelligence, 1944, "An Evaluation Of German Capabilities In 1945"
4. Federal Bureau of Investigation, United States Department of Justice File Number 65-57183, "Patent Verwertungs Gesellschaft Espionage", American Embassy, London
5. Hogg, I. V., 1970, page 48, German Secret Weapons Of World War 2, Arco Publishing Company, Inc., New York
6. Federal Bureau of Investigation, United States Department of Justice, File Number 65-57193, "Patent Verwertungs Gesellschaft Espionage", American Embassy, London
7. Vesco, Renato, 1976, pages 156-157
8. Vesco, Renato, 1976, pages 134-135
9. *ibid*
10. Moore, W. L., date unknown, page number not specified in publication, " #4510 Research File Project "y" and the 'Avro' Flying Disc", W. L. Moore Publications, Burbank, California
11. Campagna, Palmiro, 2000, pages 74 and 75, "Nazi UFO? Released documents increase speculation that Nazis did research disc technology", Article from UFO Magazine, United Kingdom
12. Luftfahrt International, 1975, page 1366, "Deutsche Flugkreisel Gab's die?"
13. Vesco, Renato, 1976, page 145
14. Lyne, William R., 1999, pages 206-207, Space Aliens, Creatopia Productions, Lamy, New Mexico
15. Vesco, Renato, 1976, page 157
16. Zollikofer, Otto, February 3, 1955, "Die Fliegenden Teller Ein Deutungsversuch", an article appearing in the Neue Zuercher Zeitung
17. Vesco, Renato, 1976, page 134
18. Vesco, Renato, 1976, page 158
19. *ibid*
20. *ibid*
21. Vesco, Renato, 1976, page 145
22. Landig, Wilhelm, 1971, page 27, Goetzen Gegen Thule, Volksturm Wilhelm Landig, Vienna, Austria
23. *ibid*
24. Piccard, George, 1999, Liquid Conspiracy JFKr LSD. The CIA, Area 51. And UFOs. Adventures Unlimited Press, Kempton, Illinois
25. Cook, Nick, 2001, page 188, The Hunt For Zero Point One Man's Journey To Discover The Biggest Secret Since The Invention Of The Atom Bomb. The Random House Group Limited, 20 Vauxhall Bridge Road, London, SW1V 2SA
26. Cook, Nick, 2001, page 195
27. Cook, Nick, 2001, page 194



28. Cook, Nick, 2001, page 192
29. Cook, Nick, 2001, page 198
30. Stoll, Axel Ph.D., 2001, page 12, Hochtechnologie Im Dritten Reich Reichsdeutsche Entwicklungen und die vermutlich wahre Herkunft der "UFOs" . Amun-Verlag, Schleusesiedlung 2, D-98553
31. Stoll, Axe., Ph.D., 2001, pages 106 and 107.
32. ibid
33. Alleged photocopy of SS plans for a Haunebu II being designed in 1943. From the German book Die Dunkle Seite Des Mondes (The DarkSide of the Moon) by Brad Harris (1996, Pandora Books, Germany).

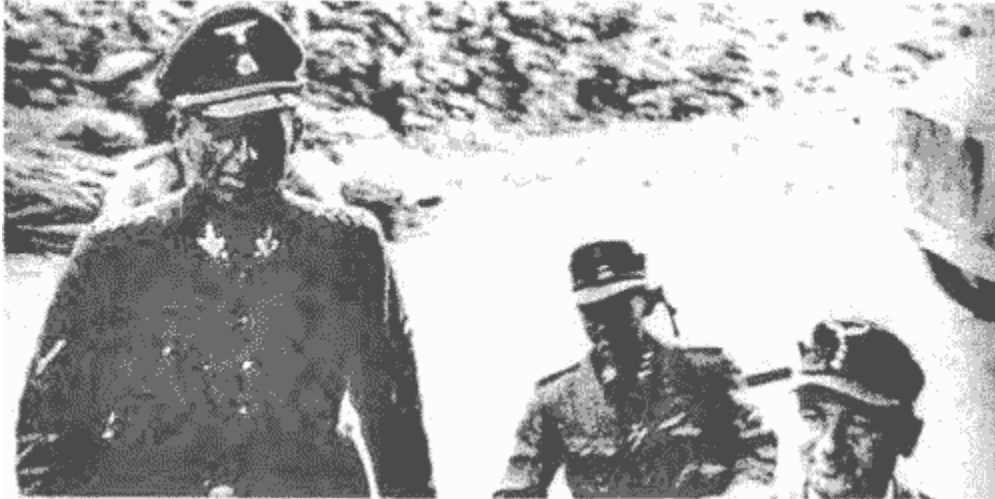

SS-Gruppenfuhrer Hans Kammler circa 1944. He was allegedly in charge of the Polish saucer bases.

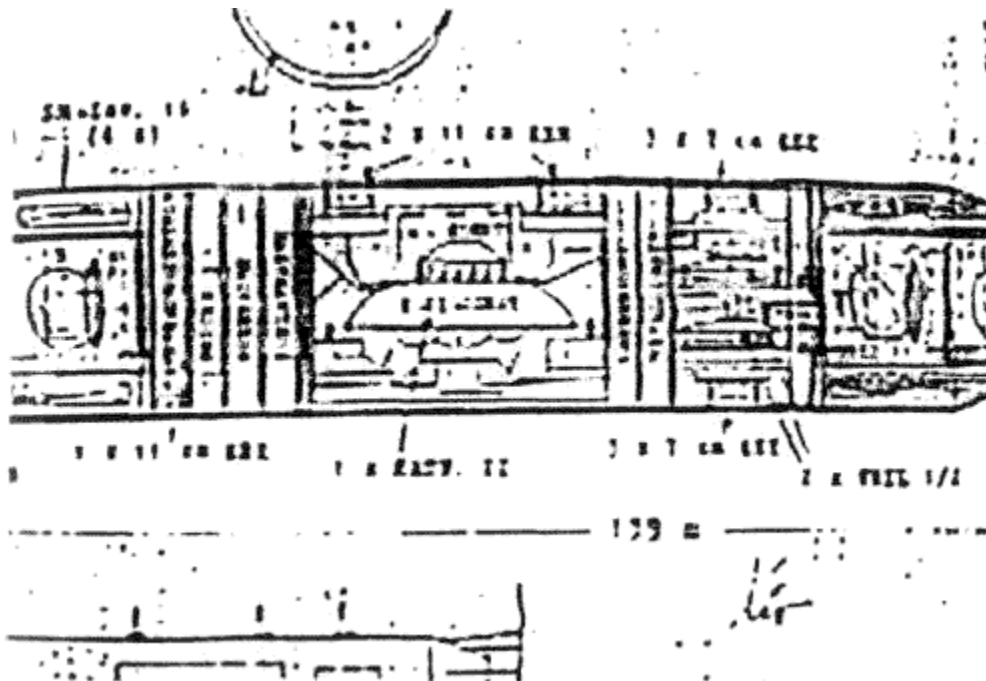

Internal plans for a "mothership" craft called "Andromeda," according to Polish historian Igor Witkowski.



One of the books on "Hitler's Super Weapons" by Polish military historian Igor Witkowski.

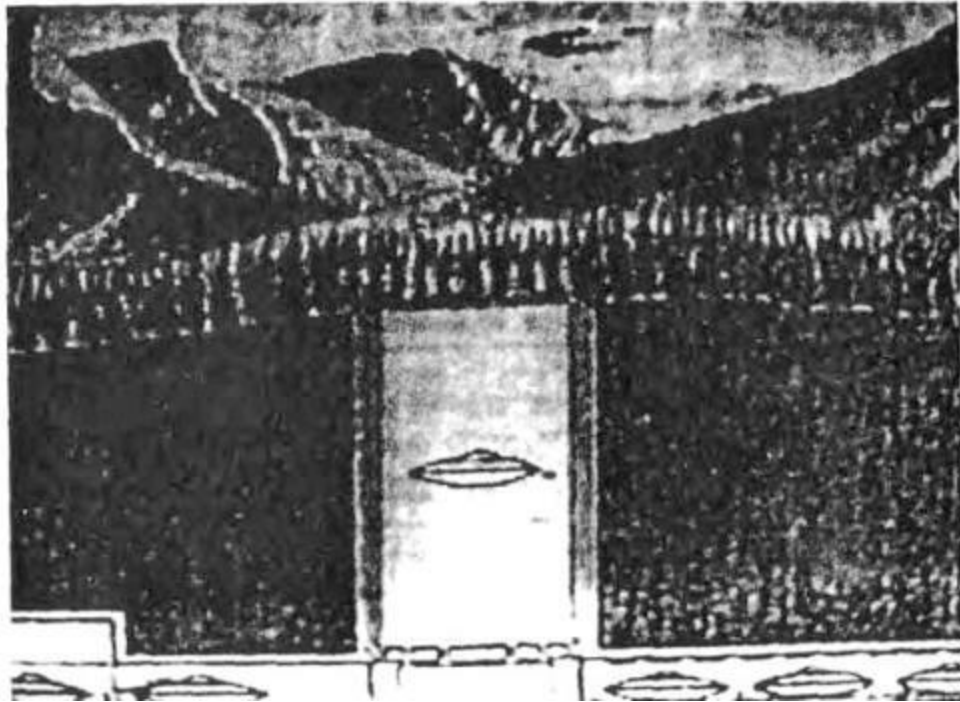

German plans for an underground saucer base, according to Polish historian Igor Witkowski.

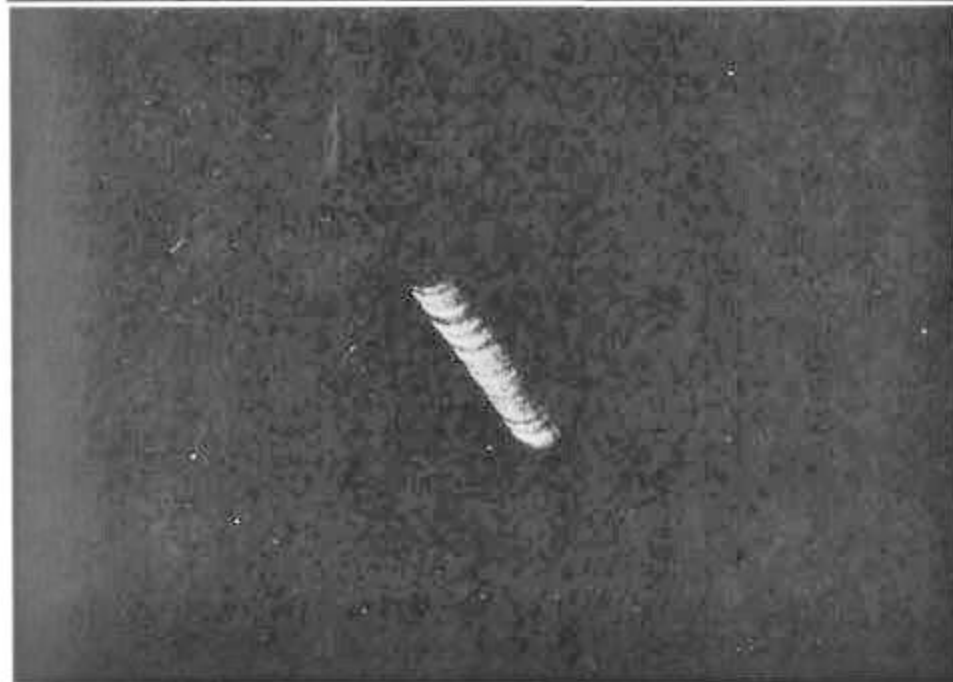

Above: Photos from the Project Blue Book files of a cylindrical UFO that hovered over New York City on March 30, 1950. The military suggested that it was possibly "the Moon." The photographer's name was deleted from the Project's files, as were most of the names when the material was finally declassified and released. These are some of the best photographs of a cylindrical UFO, thought to be a "Mothership" that would launch flying saucers.

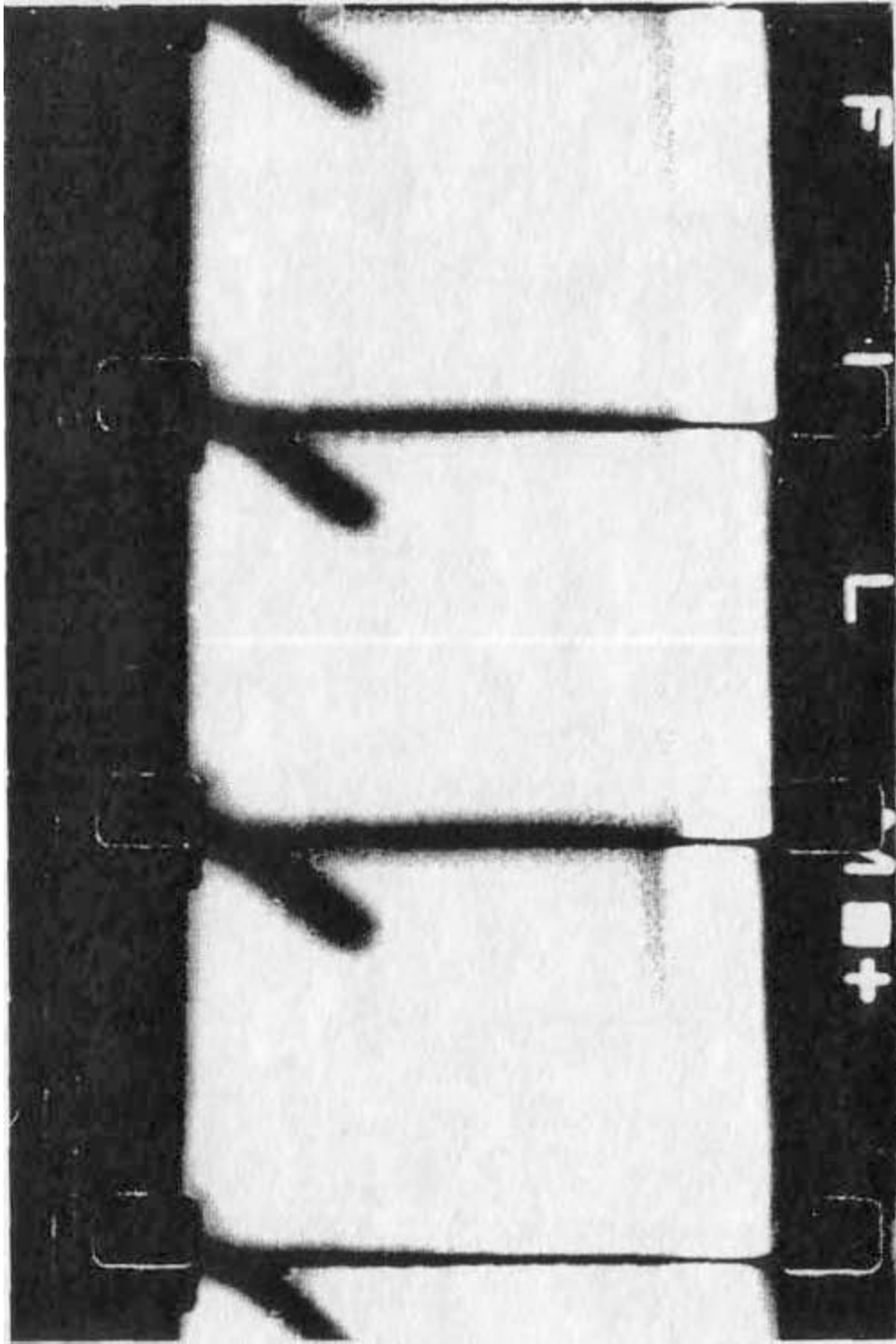

Above: Project Blue Book examined this gun-camera film footage from Victorville, California taken on February 2, 1953. It apparently shows a cylindrical "Mothership" in flight.

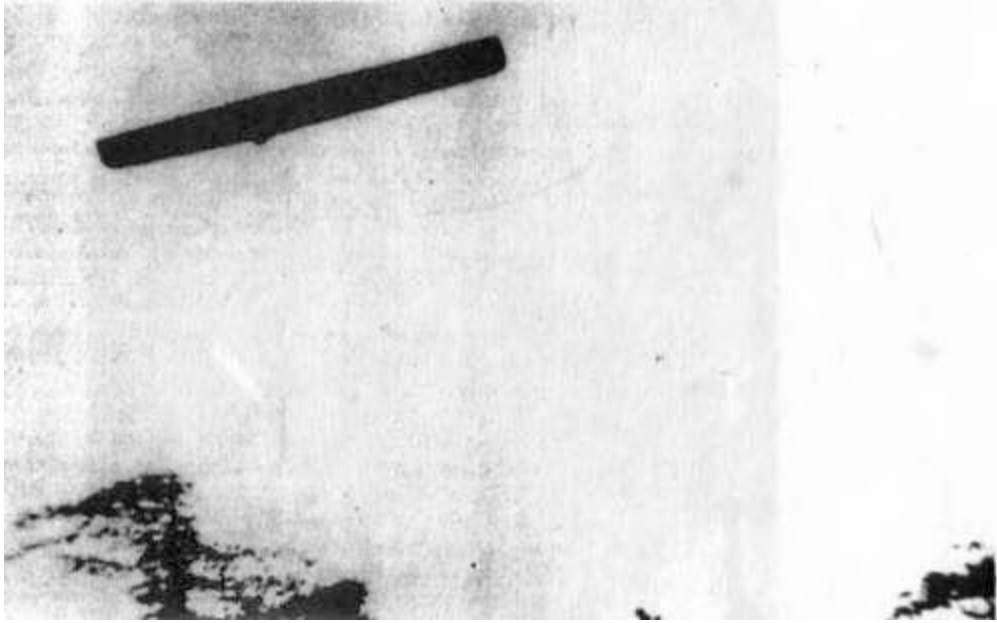

A classic cigar-shaped UFO allegedly seen by Joe Ferriere near Woonsocket, Rhode Island in the early 1950s. Ferriere claimed that a dome-shaped object, which he also photographed, emerged from the craft. Observers have pointed out that craft is remarkable for its ability to absorb light, being almost completely non-reflective.

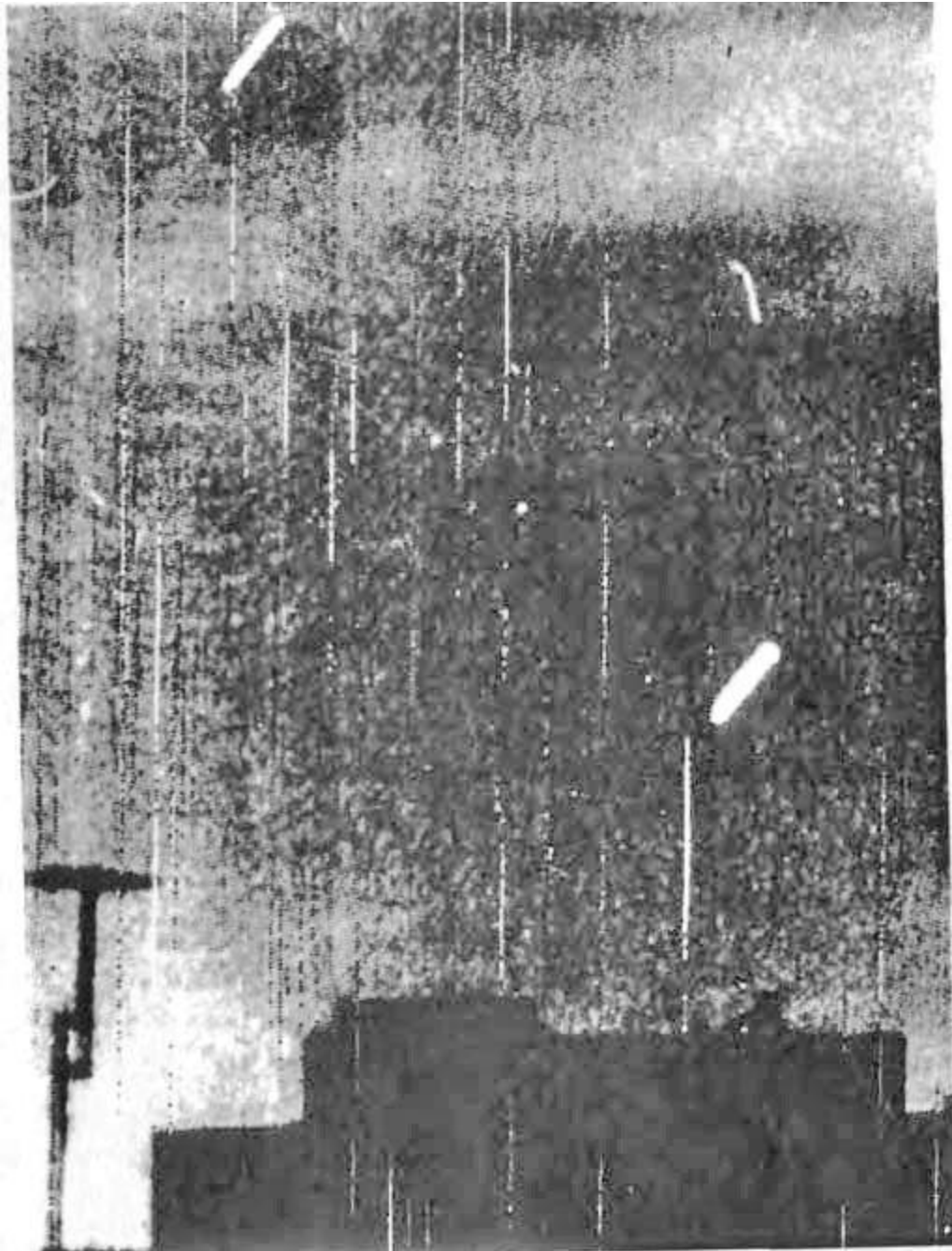

Above: Two cylindrical objects were photographed in a one-minute exposure hovering over Buenos Aires, Argentina in 1965. They remained stationary over the city for 10 minutes and then departed at very high speed according to witnesses.



## [Index](#)

### **CHAPTER SIX: "SONDERBUERO"**

A topic worthy of discussion is the alleged German agency called "Sonderbuero" or Special Bureau. Sonderbuero is sometimes also referenced by a sub-bureau working within it called "Operation Uranus" or "U-13". In the past, debate has centered around the reality of Sonderbuero. Discussion of Sonderbuero or Sonderbuero-13 have been made recently by Juergen-Ratthofer (1),and Zunneck (2).

There is no real record of Sonderbuero in official sources. Searches have been made in Germany as well as in the U.S.A. under provisions of the Freedom Of Information Act. All inquiries came back with negative results. This, however, may not

be the final word on the subject. German sources may be classified or buried within another designation. The American Freedom Of Information Act is something less than advertised as anyone ever attempting to use these provisions knows full well.

Rather than get "official" about Sonderbuero, please let me relate what is said about it, its relation to this story and to the history of UFOs as a whole. With this information the reader can make up his or her own mind about the subject.

It is said that in Germany during the war there was a quest to make Germany independent of outside energy sources. An organization was formed to investigate things we would now call "alternative energy". This included, among other things, the making of synthetic fuel and lubricants out of coal using a special process which was perfected by the Germans during the war. But it may have, and probably did, included other, more exotic, research encompassing into such topics as nuclear energy and possibly even "free energy" or "new energy".

A spin off of this research was said by Juergen-Ratthofer to have yielded field propulsion. Research toward this end was said to have been conducted by Sonderbuero. About this time strange things were taking to the skies in Germany. To keep a lid on publicity, the following scenario is cited by Juergen-Ratthofer to have been employed (3).

Germany was surrounded by enemies and their agents permeated much of the German war effort. The Germans needed to get control over what was accidentally seen by spies. To do this they enlisted the help of an unwitting German civilian population. An attempt was consciously made by Sonderbuero to "spin" reports of these sightings as they came in from civilian sources. A sub-department was set up within Special Bureau which sent out orders, countrywide, that all sightings of unusual flying craft be reported directly to that office and not discussed or publicized.

So while a German governmental agency is doing research and testing on unconventional aircraft, at this same time the same agency is gathering reports from the citizenry on sightings of unconventional aircraft. In order to confuse and disguise real testing from the Allies or their agents in Germany, a spin could be put on those sightings describing them as something other than what they were. Of course, all this time, the German civilians are believing the point is to observe and report Allied secret spy aircraft or other Allied secret weaponry. The Allied intelligence agencies may have even bought into this ruse. Remember, this was a German operation to fool its own people and so envelope Allied intelligence gathering organizations in this deception. This was done very subtly and very cleverly.

But what evidence do we really have that this actually occurred? After all, there is no official mention on Sonderbuero. Perhaps there is an overall picture. Let us see if we can find a pattern. After cessation of hostilities the Allies, especially the Americans, seized every piece of German technology they could lay their hands on. They also seized every scientist, manager, and technician having anything to do with the German scientific community, military, or intelligence service. The hardware was analyzed and the personnel interviewed. In some cases both were retaken to America for further study.

The technology was reconstructed and further developed. In America the latest German jet technology made its appearance five years later in the Korean War. America got its hands on the V-1 which was further developed into the cruise missile. America got the V-2 which was further developed into intercontinental ballistic missiles and into our space program culminating in our landing on the moon. America got the V-3, the high pressure cannon, further developed by Dr. Gerald Bull into Iraq's super cannon, which, after being pointed at Israel was the real trigger for the Gulf War. And America got at least part of the German saucer program, the outcome of which was the Silver Bug Program, the Lenticular Reentry Vehicle project recently disclosed under pressure of the Freedom Of Information Act, and the UFO activity reported at Area 51. There are probably other examples which are, as of yet, undisclosed. Many other examples of technology transfer exist but the point need not be belabored.

America received more than just technical assistance from the Germans. For example, they received the services of General Reinhard Gehlen, former intelligence chief of the German Army General Staff on the eastern front. Gehlen turned over to the Americans his entire spy apparatus, giving a then blinded America an eye into Soviet military objectives. Further, he set up and modernized our intelligence apparatus, culminating in the C.I.A., as a means to counter the Soviet threat. This spy effort was massive but please keep it in mind as we turn our attention to something smaller and seemingly less significant.

As mentioned, in the 1950s the United States Air Force was busy developing and testing flying saucers derived from captured German technology. Of course, the Air Force wanted it to remain a secret project, after all, we were involved in a Cold War. Given this problem might the Americans have asked the question as they always did: How did the Germans do this? If they did they would have formed, as an adjunct to the secret saucer programs, a program to gather material on all civilian sightings of strange unidentified flying objects, under the cover of national security, as if an external threat existed.



This agency would have then been in a position to "explain" or spin the data so as not to alarm the populace while still maintaining secrecy concerning its own projects.

As the reader may have surmised by now, this is exactly what the United States Air Force did so successfully in the form of Project Blue Book and its predecessors. The Air Force experimented on flying saucers on one hand while gathering reported sightings from civilians on the other hand, spinning and manipulating the information according to dictates of their agenda.

When viewed in this perspective, the similarity between Sonderbuero and Project Blue Book is striking. Is not the greatest evidence for the existence of Sonderbuero the American pattern of imitation which infiltrated all post-war intelligence work? The only real question is whether the Germans originated the term "swamp gas" or if this was an American embellishment.

Although not central to our discussion, one might ask why, if it was successful, why was Project Blue Book suspended? Remember that the Americans tried to further develop German ideas. In this case the solution was so imaginative and uniquely American that the Pentagon must have resounded with the reverberation of back-slapping and belly laughs at its implementation.

Remember Mark Twain's tale of Tom Sawyer whitewashing the picket fence? Instead of being compelled to an afternoon of drudgery, Tom pretended to his friends that this work was play. Not only did he enlist them to do the painting, but his friends were so eager to help paint that they paid Tom to do this work.

The United States Air Force followed this paradigm. They infiltrated an existing civilian intelligence gathering organization researching UFOs. They did this at no cost to the United States Air Force or any other governmental intelligence service. There were no official records, and no accounting trail. And best of all those doing the work and volunteering the intelligence would pay for the privilege in the form of dues to maintain the organization. If there is any question in the reader's mind as to whether MUFON (Mutual UFO Network) has been co-opted, ask yourself this question: would the intelligence services of the United States government allow the largest civilian intelligence gathering agency in the world to operate within its purview without at least monitoring it? Of course the answer is a resounding "no". This is one reason why MUFON is allowed to remain in operation within the USA without attempts to discredit it.

Given this sophisticated government intervention, would it not be a simple matter not only to manipulate the incoming sightings data, but to spin and confuse the debate concerning the origins of UFOs, even setting the agenda for the entire inquiry? Perhaps this is the reason MUFON has taken such a negative view of terrestrially originating UFOs and of the German origin of UFOs in particular. In the early 1990s, this writer was told via telephone from his home in Texas by the head man of MUFON himself that: "We investigated that a long time ago and found nothing to it". The "that" referred to was German saucers.

As an aside, he further went on to say that the idea of a German origin would for UFOs would not even be on the table for discussion if it were not for one, Vladimir Terziski, who, "is the guy pushing it", to directly quote this individual. Mr. Terziski has formed his own ideas about German saucers which he has never been afraid to share, and, to his undying credit, he stood up and lectured on this topic to the faces of MUFON in the very temples of the alien world, UFO conferences, worldwide. Mr. Terziski, almost alone, forced these facts into those conferences and subsequently forced all those UFO magazines to deal with the subject of German flying discs. And although he never got credit for it, he also supplied the technical assistance for a world famous Japanese television producer to bring an hour of this German saucer story to Japan in prime-time. Mr. Terziski, almost single-handedly, opened up two continents to this UFO reality.

MUFON's successful existence is tied to their implicit and explicit assumptions of UFOs as alien machines. The greatest appeal the extraterrestrial hypothesis has for the government is that this hypothesis is simply not testable. MUFON does not even try to test anything. Instead, they chase sightings. They train their followers to take meaningless celestial measurements accompanying these sightings and then analyze this "data" into gibberish. MUFON then lends itself to endless rambling speculation involving increasingly more exotic alien scenarios.

It is not MUFON's rank and file membership which is to blame. The individuals I have met are honest and sincere as are 99% of all the participants in the quest to understand these mysterious flying objects. Their methods may stimulate UFO interest and UFO enthusiasts but it utterly fails to advance our quest for knowledge about these devices. This is perfectly alright with the behind the scenes government manipulators, however, since this result is their real goal. It is unknown to what extent the Americans have succeeded in improving and further developing the original German saucers. The extent to which they have succeeded in further developing Sonderbuero, however, should be apparent to all.

## Sources and References

Zunneck, Karl-Heinz, 1998, page 125, Geheimtechnologien, Wunderwaffen Und Irdischen Facetten Des UFO-Phaenomens, CTT-Verlag, Suhl, Germany

Two photos taken by a barber named Ralph Ditter, in Zanesville, Ohio on November 13, 1966. Ditter was leaving home with his camera when he chanced to look back and saw the UFO over his house. He took two exposures within a short period of time of the helmet-like craft, with an apparent "canon" on the underside of the craft. Ditter did not seek publicity but put them in his shop window to stimulate business. Eventually a news service bought them and they were widely published. The object is similar to the "Heflin UFO" and is said to be an original German design with a Panzer Tank canon mounted beneath it. Such a craft at such a late date would tend to indicate that this was not a captured test craft but rather a "renegade craft" possibly from South America as late as 1966.



Above: Aerospace expert Stuart Nixon, executive director of the National Investigations Committee on Aerial Phenomena (NICAP), which was founded in Washington, DC, in 1956 to conduct a civilian study of UFOs. Note the apparent "cannon barrel" beneath the craft.

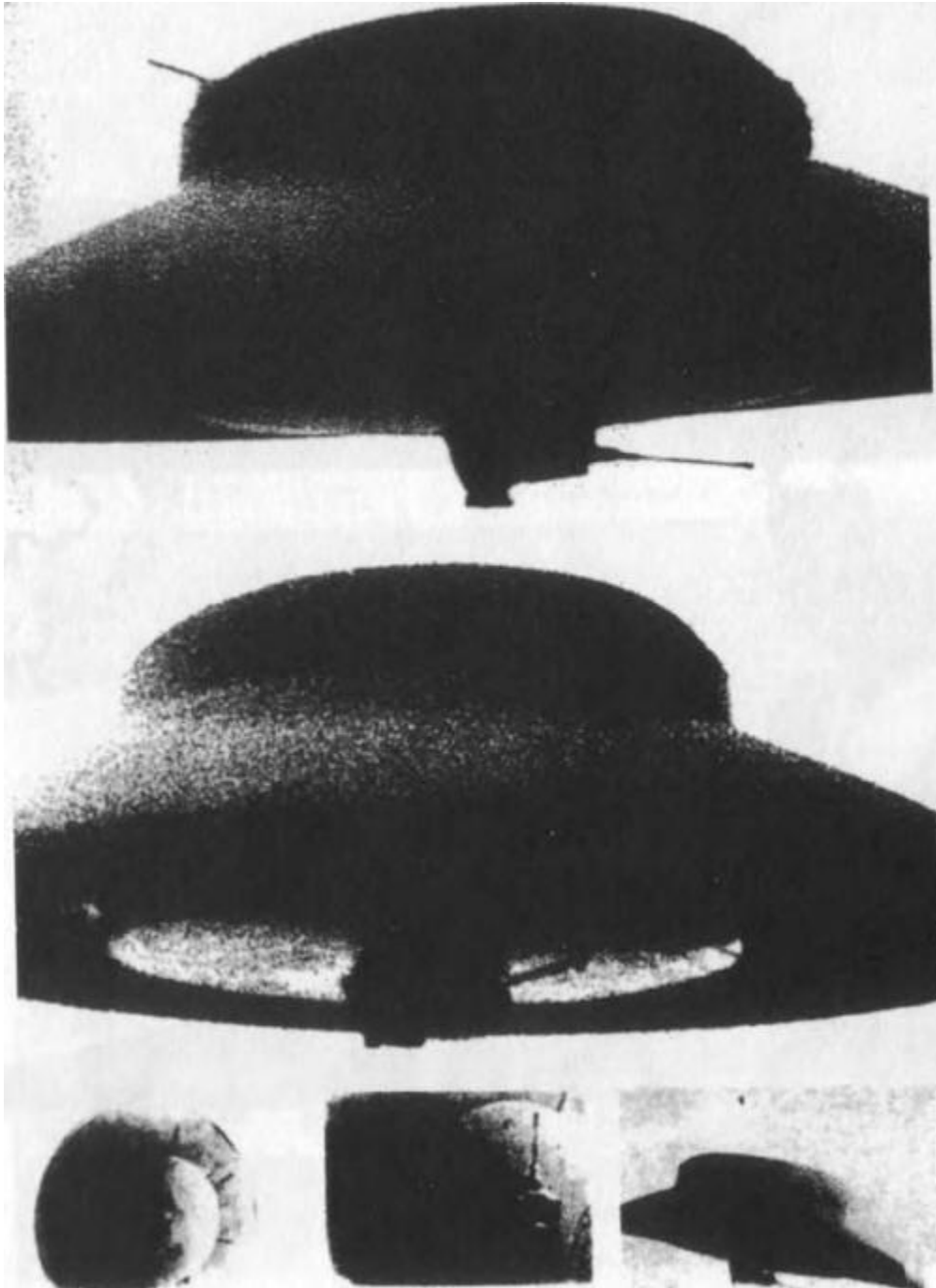

Alleged photos from SS files of a Haunebu II in flight circa 1944. Note the Panzer tank canon mounted underneath the craft. From the German book *Die Dunkle Seite Des Mondes* (The Dark Side of the Moon) by Brad Harris (1996, Pandora Books, Germany).

[Index](#)

CHAPTER SEVEN:

**DISPOSITION OF GERMAN SAUCER TECHNOLOGY AFTER THE WAR**



The question arises as to what ever became of the saucer designs and saucer designers referred to in this discussion? For some there are easy answers. For others, there whereabouts after the war is more clouded.

Dr. Richard Miethe, for instance, has been rumored to have gone to work in Canada on the joint Canadian-U.S. Air Force saucer project. Dr. Miethe is not the only German scientist very willing to start construction on a post-war flying disc. All the scientists involved, with the exception of Rudolf Schriever, seem to have been eager to begin at once.

Heinrich Fleissner, who claimed to have been a technical advisor on a German flying disc project at Peenemuende, filed an American patent for a flying disc on March 28, 1955. This was patent number 2,939,648 which can be obtained from the United States Department of Commerce, U.S. Patent Office for a small fee. The patent was not granted until June 7, 1960, a delay of over five years. One can not help but wonder if the delay Fleissner experienced had anything to do with

the work going on at the same time at the A.V. Roe, Limited organization or the black project to develop the Lenticular Reentry Vehicle or even on some black project which is still undisclosed.

Another German saucer designer eager to get things rolling after the war was Georg Klein. When asked about future plans in the Tages-Anzeiger fuer Stadt und Kanton Zuerich on September 18, 1954, Klein replied that he had already demonstrated a flying saucer model utilizing electric propulsion.

But probably the most anxious to begin work, no matter the obstacles, was Joseph Andreas Epp. This is said because according to government files, which were first located by researcher Mark Kneipp, Epp went so far as to enlist in the Soviet flying saucer project which began immediately after the war in East Germany using former German scientists (1).

#### Post-War Soviet "German" Saucer

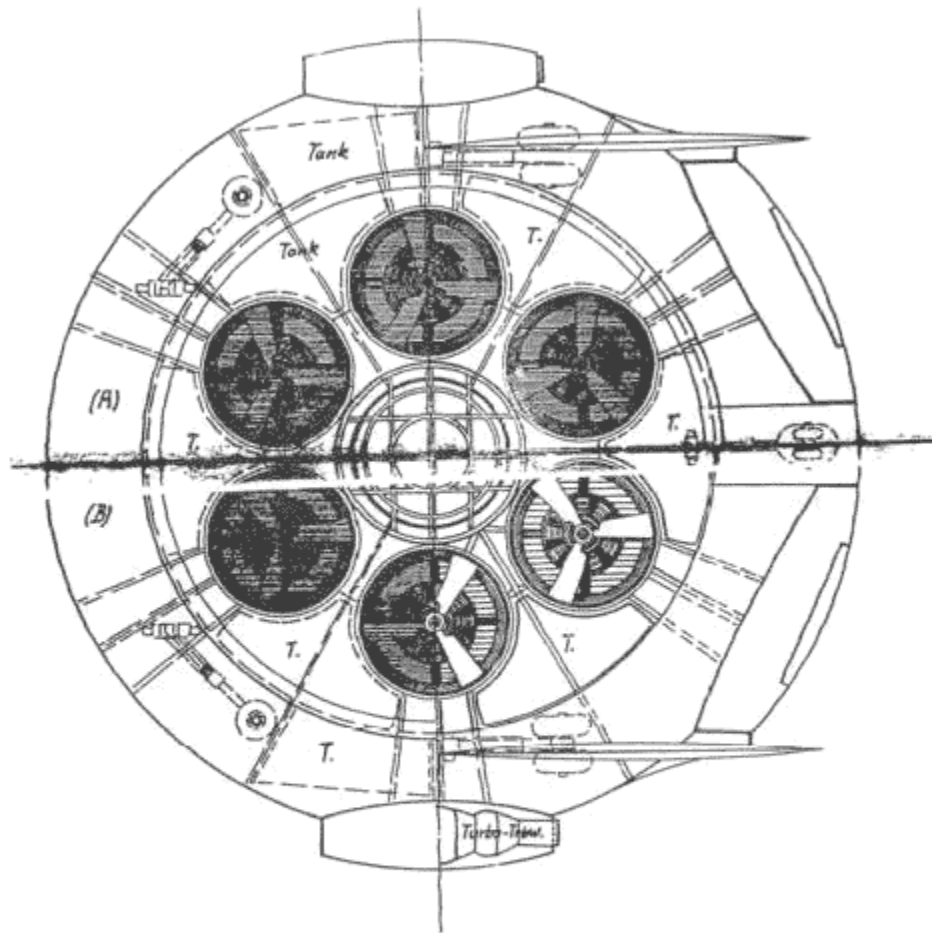

	<i>Udss R.</i>	<i>Datum</i> <i>29.11.50</i>
	<i>Rekonstruktion 7/54.</i>	<i>Prüfer</i> <i>DDR</i>
	<i>Nr. 4-6642-0-7/54.</i>	<i>Skala:</i> <i>1:100</i>
	<i>gepaust am: 27. III. 57. (mizma)</i>	

After the war J. Andreas Epp worked briefly for the Soviets along with other German experts on a flying saucer. This is a drawing he made of the Soviet saucer. It was to be used in the polar regions.

According to this F.B.I. file which was secluded by the National Archives, Epp became disenchanted with the Soviets after working for them for about a year. He then defected to the West. Epp re-drew their designs from his seemingly photographic memory. He provided detailed test and technical specifications, including his apparent area of specialty, the steering linkage system. His comments were that the type of flying craft being built for the Soviets was especially designed for polar conditions.

After settling in Bavaria, Epp continued design work on flying discs himself. He designed the "Omega Disc" which is remarkably similar to the Soviet design. Epp was very interested in working for Bell Aircraft, builders of the X-1 which broke the sound barrier in 1947. Epp sent me copies of correspondence with Dr. Walter Dornberger, at this time executive of Bell Aircraft, who, at one time was Dr. Wernher von Braun's boss at Peenemuende. Epp did mention the flying saucer in this correspondence. Nothing came of it, however. To his death in 1997, Andreas Epp was still trying to realize this dream of building a flying saucer.

These are the stories of saucer designers of which we know something. There were others of which we have completely lost track. Otto Habermohl is one of these. Habermohl was presumed captured by the Soviets. This presumption seems to be solely based on the fact that he disappeared after the capture of Prag.

What about the post-war disposition of the flying saucers themselves? We know, for instance, that examples were destroyed by the Germans so the advancing Allies would not benefit from them. This very thing happened to saucers designed by the Schriever-Habermohl team at Prag. The scorched earth policy was a standing solution and ruthlessly imposed by the SS, especially concerning German high technology. Yet we all know flying saucers did not disappear after the collapse of Germany, as a matter of fact quite the contrary. Michael X. Barton tells us that their earliest appearance was not over the State of Washington in 1947 as usually given but in South America. In fact, there were many sightings of UFOs in South America during this post-war time frame. Latin American sightings continue to this day.

South America is a long way from the USA. Even if the Americans were experimenting with captured German technology at that time, the sightings from other parts of the world can not be explained as originating from the USA. There must be more at work here.

Could die-hard Nazis have exported this technology to a stronghold in the Antarctic or Andes as some often claim? Or did these craft appear from "Beaver Dam", a secret German base on the east coast of Greenland as disclosed by Dr. Jesensky and Mr. Lesniakiewicz (2). Was part of this technology appropriated by the British and further developed in Canada as stated by Renato Vesco? Or was this technology completely absorbed by the USA in a secret deal with Admiral Karl Doenitz after Hitler's death as stated by Bill Lyne (3)?

In the first of the aforementioned possibilities, these die-hard Nazis and their technology, including saucers, are sometimes called the "Third Power" by German writers on the subject. The Third Power is meant to signify a power besides the West (the First Power) or the East (the Second Power). The Third Power allegedly operates in secret as regards the general population of this planet but is very well known to the First and Second Powers. The sole reason the Third Power has survived is their high technology and high finance both of which resulted from picking clean the bones of the Third Reich. The story is as follows and at least some of it is factual.

It is known that the Germans made contingency plans for the war's loss. On August 10, 1944, nine months before the war in Europe ended, a meeting was called at the hotel Rotes Haus in Strassbourg. In attendance were representatives of all the major German industrial concerns including I.G. Farben, Thyssen, Siemens, Krupp, Daimler-Benz, Rheinmetall-Borsig, as well as representatives of the major German banks. Meeting with them were members of the SS. They were planning measures which would insure their survival after the coming German defeat (4).

Scientists, scientific plans, strategic materials, and money were to be taken from Germany and secured in secret hiding places. Long range cargo aircraft were to fly from Germany to Spain carrying the goods. From here items were to be loaded on to U-boats bound for South America. It is possible that other destinations were also planned such as Japan and the Antarctic base originally established in 1938-1939 by the Ritscher Antarctic Expedition.

Surprisingly, the Ritscher Antarctic Expedition (1937-38) was setup and funded by Hermann Goering, head of the German Air Force. The ship Schwabenland, equipped with amphibious aircraft which could be launched via catapult explored, mapped and claimed a large portion of the Antarctic Continent for Germany during this expedition. Weighted metal flags were dropped from these aircraft clearly delineating the territory in which Germany was claiming. The territory included ice-free lakes which were naturally heated from below by geothermal means (5). Along the line of these lakes a huge fault line bisects "Neuschwabenland", as it was called, so presumably a permanent heat source was built into this new territory. One German writer has perused reports of Neuschwabenland and states that during the war repeated trips were made to this vicinity at which time a permanent base was established there (6). Another writer, Wilhelm Landig, in novel form, describes this and other secret post-war German bases in Antarctica, the Andes as well as a secret polar base near the North Pole (7). Mr. Landig recently died and it is now known that he was a Third Reich insider and knew of which he wrote. As mentioned earlier, it is now known that Landig was a member of the Waffen SS and at one time was responsible for security for the development of German saucers (8). He knew that of which he spoke. His books each bore the sub-

title "Ein Roman voller Wirklichkeiten" or "a novel filled with realities" as this novel treatment was an easy avenue in avoiding post-war legal entanglements.

Through the descriptions of the writers mentioned and other records it is possible to pinpoint the location of these secret German bases in Antarctica as well as a large Andean base in Chile. Bill Lyne as well as Mr. Robert Lesniakiewicz and Dr. Milos Jesensky state that a mysterious polar base existed in Greenland (9) (10). The latter writers cite the coast of eastern Greenland and cite a code-name which translates into "Beaver Dam", complete with underwater U-boat entrances.

The Antarctic base was first attacked by forces of many nations, led by the United States, in a 1946 military action code-named "Operation High Jump". This operation involved a fleet of ships, including an aircraft carrier, submarines and support craft. It also involved aircraft and four thousand armed troops under the command of Admiral Richard Byrd. Immediately four aircraft were mysteriously lost and the whole operation, scheduled for six months duration, was canceled after less than six weeks (11)(12).

The Antarctic base, Landig's Point 211 (13), was in operation until the late 1950s when it became the subject of an American nuclear "test". In this test three bombs were detonated under cover of the International Geophysical Year 1957-58 (14). Landig claims the type of rockets used in the "test" to attack Point 211 were prototypes of the American Polaris missile, a solid-fuel rocket which was used later operationally, the final design being fired from submarines underwater (15). Detonation of these atomic weapons over the base generated electromagnetic shock waves which, it was hoped, would destroy apparatus in the base used for defensive purposes (16). Landig claims this tactic failed. The electromagnetic pulse attack was insufficient to destroy the improved apparatus (17). Both "High Jump" and this 1957-58 attack turned out not only to be a fiasco, but to be superfluous. The greater part of the German forces had already abandon the Antarctic base in favor of a base in the South American Andes.

Landig claims that the reason for its abandonment was the purity of the atmosphere in the Antarctic which is almost germ-free (18). It seems that the human immune system needs constant challenge to remain healthy even if this challenge does not always result in illness. Without a constant influx of visitors supplying this challenge, the staff on-hand lost almost all immunity to infection after a few years. The common cold became a serious matter.

As mentioned earlier, writers Dr. Milos Jesensky and Robert Lesniakiewicz see the origin of flying saucers over the USA during the late 1950s as coming from a forgotten German facility called "Beaver Dam" in Eastern Greenland. According to these writers, this base did not surrender with the fall of Germany but continued to function. It was from this base that flying saucers were directed to the USA on spy missions, especially toward our nuclear facilities in New Mexico. Additionally, one wonders if this base was the real origin of the ghost rockets seen moving south from Northwestern Europe immediately after the war. The status of this base today is unknown.

There is no doubt that the Germans had bases in the Arctic. German bases were located on Soviet soil, as well as the soil of Greenland which belonged to Denmark. Denmark had been overrun by the Germans early in the war. What is most surprising is that Landig's claim that the Germans maintained a base in the high Canadian arctic right under the noses of Canada and the USA (19).

Is this all fantasy? Is there any hard evidence for secret post-war German bases? Has a post-war German base ever been discovered? Yes, one has. New evidence for this exodus theory comes to us from the discovery of a German U-boat way-station in the Atlantic which had a hand in moving this clandestine cargo from Europe to the austral world well after the war, right into the 1950s. This information is revealed in an article in the July, 1984 issue of Nugget magazine titled "Der U-Boot Bunker von Fuerteventura" (20). Fuerteventura is the eastern most island of the Canary Island chain and lies just out of sight off the west coast of North Africa.

Geologically, the base was formed by an huge, ancient volcanic bubble around which the molten rock solidified in the center of the island. According to the article, the Germans brought in excavation equipment and bored out three tunnels for underwater access by U-boats. On top of the island, directly over the bubble and the military facility rested a villa with a stairway leading down to the base from the cellar. The villa was owned by a respectable German family, named Winter. This base functioned during the war as a secret U-boat base for the Germans. It continued this function after the war as a way-station for transport U-boats.

In our modern world of science and academic history this claim of lost islands and hidden bases sounds like something out of a Jules Verne fantasy. If such a base really existed, would we all not be aware of its existence above and beyond an obscure reference in a publication which mainly deals with treasure hunting?





Top: **Neuschwabenland** (Antarctica). Bottom: "**Colonia Dignidad**" in Argentina near Chilean border comprising 25,000 quadratkilometers (over half as large as Switzerland)

The subterranean island base was actually visited by two eyewitnesses, according to the Nugget report. There, two derelict U-boats were discovered which had remained undetected for over thirty years. One of these U-boats was entered by the two adventurers. Inside they found detailed nautical maps of South America. To add to the mystery, the assertion is made that these U-boats and this base functioned with the full knowledge of the U.S. government right into the 1950s.

This base would have formed a physical link between the ports of Spain and destinations in South America. Perhaps even bridging bases in Greenland with Antarctica, if certain reports are true. It is also fuel for the argument that a technological transfer actually took place between the Third Reich and entities in the Southern Hemisphere. As surely as die-hard Nazis spread into the Southern Hemisphere sightings of flying saucers followed. Further, if the government of the United States knew of this transfer and these U-boat bases then there then there may have been some actual political link or understanding between the government of the United States and the post-war Nazis, the "Third Power".

If his words are read carefully, Landig's Point 211, the Antarctic base, can be located on the maps he supplies (21). Until, however, this base is visited and excavated and the evidence made public, this base along with the ones in Canada and Greenland constitute more speculation than fact. This is not true, however, in the South American situation.

In the immediate post-war world South America was a haven for Germans who could not stomach Occupied Germany for one reason or another. The political climate in these countries was favorable toward these refugees. Nazi gold and money was transferred to South America, particularly Argentina. Hunted Nazis found a market for their services in a variety of occupations. SS organizations set up shop as they had in Franco's Spain. These facts are hardly in dispute. They are covered in detail by Infield (22) as well as by Farago (23) a whole genre of "Nazi Hunter" writers. What is less often mentioned is that German technical people infused these countries with expertise gained during the Second World War. For instance, Argentina and Brazil had state-of-the-art jet fighters in the 1950s thanks to the efforts of German immigrant scientists and technicians.

Along with this monetary and technical transfer, large landholdings were purchased, secured and set aside with the full knowledge of the South American governments in power. From these vast secure areas members of these German organizations simply did as they pleased. It is not out of the question to think that the flying saucers seen in the late 1940s and 1950, both conventional and field propulsion, were built and flown from these bases. One of these Andean bases, referred to as "Colonia Dignidad" consisted a land area half the size of Switzerland (24). This is certainly more than enough room to develop hide anything.

The South American industrial base during these times was more than adequate to make these saucers. But even if this were not true, this is no argument against construction of flying saucers in South America. Parts could have been ordered from suppliers in other countries as are done by major aircraft firms today. Each major aircraft firm has a host of sub-contractors who manufacture everything from individual screws to complete sub-assemblies. Many if not most of these sub-contractors are accustomed to filling these orders without ever knowing what the final assembled product will be. This is part of the security system and unquestioned. Germans working in South America would have no trouble using this system. They could have even ordered parts and sub-assemblies from companies in Europe and the USA.

This is exactly what Dr. Gerald Bull did in Iraq when he built the largest of his high-pressure cannons for that country. This nearly mile long fixed gun was built resting on the slope of a hill pointed at Tel Aviv. It would have been able to shoot projectiles weighing about 1800 pounds. Parts were built by sub-contractors all over the world and sent to Iraq for assembly where it was nearly completed. The sub-contractors were lied to or otherwise kept in the dark as to the purpose of their components. It was only by chance that word of this project reached the hands of opposing intelligence services. The result was near panic in the intelligence services of these countries. What followed was the assassination of Dr. Gerald Bull and a diplomatic ruse which bated Saddam Hussein into an invasion of Kuwait. This invasion facilitated the entry of the Americans into the conflict. The high pressure cannon was destroyed immediately, even though it was pointed in the opposite direction from Kuwait. If this risky, bulky weapon's system could be almost completed using a system of unwitting sub-contractors world-wide, imagine how easily a one-off flying vehicle could be built using the same system.

Richard Ross, a UFO researcher based in Austin, Texas, reports that even today vast tracts of land in South America are avoided by airline pilots there because of UFO activity in these areas. He obtained this information by interviewing the South American airline pilots themselves. He goes on to make the point that Latin America is a hotbed of UFO activity. Reports of this activity for some reason never find their way into the mainstream American news media.

There still remains one possible hiding place on European soil. There remains the possibility that German flying discs were flown to Switzerland during the last moments of the 3rd Reich and hidden there in the vast system of caves built there for defensive purposes by the Swiss. This would imply a limited partnership with the Swiss concerning a technology that neither country wanted to lose. In modern times we have witnessed something similar when Iraq flew its jet aircraft to Iran for safe keeping during the Gulf War. Iraq and Iran had been bitter enemies only a few years before but put these differences aside in order to save technology. If they could do it certainly the Germans and Swiss could do it also. One eye witness claims that he saw an experimental aircraft crossing the German border into Switzerland on the morning of May 9, 1945, the day after the surrender of the 3rd Reich (25). This same procedure could have taken place with even more exotic flying craft.

One of our most trusted sources, Renato Vesco believes that Canada was strongly involved in further developing captured German saucer technology. Vesco's belief seems to be that the British kept this information to themselves. That is, they did not share it with the United States. They did this in response to the latter's refusal to share atomic secrets with Great Britain. The British hid this research in the Canadian forests where they spent time and money developing it into the flying saucers of the 1950s. Somewhat related to this idea, the German researcher Klaus-Peter Rothkugel also believes post-war saucer research was the product of a massive and still-secret Anglo-American effort. Jim Wilson adds fuel to this fire in that there was apparently joint British-American-Australian involvement in the Lenticular Reentry Vehicle project (26).

Bill Lyne has another opinion. He believes all German saucer data was transferred to the government of the United States in a deal done with Admiral Karl Doenitz who was acting head of Germany for the week or so between the time Hitler shot himself in the bunker and Germany surrendered. Recently, Mark Kneipp has found some very interesting evidence which seems to support Mr. Lyne's sequence of events in this deal with Admiral Doenitz. This is one surprise I do not want to spoil so it will be left to Mr. Kneipp to reveal his research.

One real mystery remains absolutely untouched. This concerns the man who did know everything about Germany's saucer development and all its V-weaponry and other high technology for that matter. This was SS General and Doctor of Engineering Hans Kammler. Kammler first came to prominence because of his expertise in building extensive underground installations. Soon his high intelligence and "can do" attitude were recognized, resulting in a meteoric rise in rank and influence within the Third Reich. Kammler assembled the best of the best as far as weaponry was concerned and kept it close to him in the form of the Kammler Group, based at the Skoda industrial complexes near Prag. By war's end he was among the top five most powerful people in Germany. He had the entire SS technical organization to do his bidding. He was in charge of Peenemuende, "Der Riese" in modern Poland, Kordhausen, Kahla, the many facilities at the Jonas Valley in Thuringia, as well as the huge underground facility he built for himself in Austria. The Kammler Group was everywhere on the cutting edge of the cutting edge of applied technology. For instance it was the Kammler Group which was in the process of applying nuclear energy toward missile and aircraft propulsion (27).

What happened to Kammler? This was the most knowledgeable of all the German technical people. Even Albert Speer, German Minister of Munitions, admitted under Allied interrogation, that Kammler was the expert in the area of V-weapon development. This was no small admission for Speer. With the cessation of hostilities in Europe, Kammler simply waltzed off the pages of history, never to be seen or heard from again. Why, then, was there no post-war manhunt for Kammler? What are we missing here?

Tom Agoston recounts the stories of Kammler's death (28). There are five in all. They all read like pulp fiction. None are even remotely believable. As proof of this, no serious investigation was ever done into any of these stories by any of the Allied Powers. But equally shocking is the fact that Kammler was ignored by the "Nazi Hunter" aficionados. A quick call to the Simon Wiesenthal Center in Los Angeles revealed that they were not looking for Kammler and have never looked for Kammler even though they fully agreed that the stories of his death stretched credulity. This, in spite of the fact that it was Kammler who was responsible for the many slave-labor camps, including Dora and S-3, where many inmates died working for the SS.

There is a sixth possible story for Kammler's demise. Could not the answer to this enigma be found in a practice commonly given to criminals in the USA, that of the "witness protection program"? Was Kammler given a new identity in exchange for his knowledge and knowledge of where the treasure-trove of SS technical information was stored? Actually, any country in the world at the time would have made Kammler this deal in a second. He was simply too technologically valuable to lose or to involve in a showcase criminal trial. A new identity was the best way out of his problems.

One thing is striking concerning the technological history of the Twentieth Century. The preponderance of that century's technology has its roots in the 1940s. The technology we use and take for granted today was invented or developed to the utilitarian degree during this time frame. These technological roots sink most deeply into Nazi Germany. In support of this argument, there is a laundry list too long to fully recount. It ranges from synthetic materials such as plastics and artificial

rubber to metallurgy. It included the host of technologies which gave us the jet engine, rockets and so access to space travel. It includes atomic power. It also includes early semi-conductor research upon which our modern computer-based research, economy and communications are built. Technically speaking, we are still living off the Caracas of the Third Reich. Yet, still, to this day, much of that German technology remains veiled. Counted among this still-veiled technology are the German flying discs.

## Disposition of German Saucer Technology After The War

### Sources and References

1. Dossier/Joseph Andreas Epp, U.S. Army Intelligence, Record Group 319, The National Archives at College Park, College Park, Maryland.
2. Jesensky, Milos, Ph.D. and Robert Lesniakiewicz, 1998, page 143, "Wunderland" Mimoszemske Technologie Treti Rise. AosPublishing
3. Lyne, William R., 1999, page 48, [Pentagon Aliens](#), Creatopia Publishing, Lamy, New Mexico
4. Infield, Brian, 1981, page 179, Skorzeny Hitler's Commando, St. Martin's Press, New York
5. Mattern, W., date unknown, page 79, UFO's Unbekanntes Flugobjekt? Letzte Geheimwaffe des Dritten Reiches?, Samisdat Publishing, Toronto, Canada
6. Bergmann, O., 1988, page 14, 1 Deutsche Flugscheiben und U- Boote Ueberwachen Die Weltmeere. Hugin Gesellschaft Fuer Politisch-Philosophische Studiern E.V., Wetter/Ruhr
7. Landig, Wilhelm, 1971, Goetzen Gegen Thule Ein Roman voller Wirklichkeiten, Hans Pfeiffer Verlag GmbH. Hannover
8. Informationsdienst gegen Rechtsexremismus, URL address: <http://www.idgr.de/texte-1/esoterik/landig.htm>
9. Lyne, William R., 1999, page 97
10. Jesensky, Milos, Ph.D. and Robert Lesniakiewicz, 1998, page 143
11. Buechner, Howard A. Col. and Bernhart, Wilhelm Capt., 1989, Hitler's Ashes, pages 229-232, Thunderbird Press, Inc., Metairie, Louisiana
12. Landig, Wilhelm, 1991, page 571, Rebellen Fuer Thule Das Erbe Von Atlantis, Voldstum-Verlag, Wien
13. ibid
14. ibid
15. Landig, Wilhelm, 1991, page 572
16. ibid
17. ibid
18. ibid
19. Landig, Wilhelm, 1971, pages 109-142
20. Nugget, July and August editions 1984, "Der U-Boot Bunker von Fuerteventura"
21. Landig, Wilhelm, 1980, pages 486-489, Wolfzeit Um Thule, Volksturm-Verlag Wilhelm Alndig, Wein
22. Infield, Glenn B., 1981, Skorzeny Hitler's Commando. St. Martin's Press, New York
23. Farago, Ladislav, 1974, Aftermath Martin Bormann and the Fourth Reich. Simon and Schuster, New York
24. Wilson, Harvey, 1994, "Hitlers Fluchtweg nach Argentinien", in Zeiten Schrift, Sept-Nov. 1994, Number 4, Berneck, Switzerland
25. Heppner, Siegfried, 1997, page 11, "Geheimnisse...dem Deutschen Volke", self-published, A-9142, Globasnich-Podjuna, Austria
26. Wilson, Jim, November 2000, page 71, "America's Nuclear Flying Saucer", Popular Mechanics
27. Agoston, Tom, 1985, pages 13, 83-84, 87, 129, Blunder How the
28. U.S. Gave Away Nazi Supersecrets to Russia, Dodd Mead Company, Inc., New York
29. Agoston, Tom, 1985, pages 102-109

TOP SECRET  
EYES ONLY

\* TOP SECRET \*  
\*\*\*\*\*

EYES ONLY

COPY ONE OF ONE.

SUBJECT: OPERATION MAJESTIC-12 PRELIMINARY BRIEFING FOR  
PRESIDENT-ELECT EISENHOWER.

DOCUMENT PREPARED 18 NOVEMBER, 1952.

BRIEFING OFFICER: ADM. ROSCOE H. HILLENKOTTER (MJ-1)

NOTE: This document has been prepared as a preliminary briefing only. It should be regarded as introductory to a full operations briefing intended to follow.

\*\*\*\*\*

OPERATION MAJESTIC-12 is a TOP SECRET Research and Development/Intelligence operation responsible directly and only to the President of the United States. Operations of the project are carried out under control of the Majestic-12 (Majic-12) Group which was established by special classified executive order of President Truman on 24 September, 1947, upon recommendation by Dr. Vannevar Bush and Secretary James Forrestal. (See Attachment "A.") Members of the Majestic-12 Group were designated as follows:

Adm. Roscoe H. Hillenkotter  
Dr. Vannevar Bush  
Secy. James V. Forrestal  
Gen. Nathan F. Twining  
Gen. Hoyt S. Vandenberg  
Dr. Detlev Bronk  
Dr. Jerome Hunsaker  
Mr. Sidney W. Souers  
Mr. Gordon Gray  
Dr. Donald Mensel  
Gen. Robert H. Montague  
Dr. Lloyd V. Berkner

The death of Secretary Forrestal on 22 May, 1949, created a vacancy which remained unfilled until 01 August, 1950, upon which date Gen. Walter B. Smith was designated as permanent replacement.

On 24 June, 1947, a civilian pilot flying over the Cascade Mountains in the State of Washington observed nine flying disc-shaped aircraft traveling in formation at a high rate of speed. Although this was not the first known sighting of such objects, it was the first to gain widespread attention in the public media. Hundreds of reports of sightings of similar objects followed. Many of these came from highly credible military and civilian sources. These reports resulted in independent efforts by several different elements of the military to ascertain the nature and purpose of these objects in the interests of national defense. A number of witnesses were interviewed and there were several unsuccessful attempts to utilize aircraft in efforts to pursue reported discs in flight. Public reaction bordered on near hysteria at times.

In spite of these efforts, little of substance was learned about the objects until a local rancher reported that one had crashed in a remote region of New Mexico located approximately seventy-five miles northwest of Roswell Army Air Base (now Walker Field).

On 07 July, 1947, a secret operation was begun to assure recovery of the wreckage of this object for scientific study. During the course of this operation, aerial reconnaissance discovered that four small human-like beings had apparently ejected from the craft at some point before it exploded. These had fallen to earth about two miles east of the wreckage site. All four were dead and badly decomposed due to action by predators and exposure to the elements during the approximately one week time period which had elapsed before their discovery. A special scientific team took charge of removing these bodies for study. (See Attachment "C.") The wreckage of the craft was also removed to several different locations. (See Attachment "B.") Civilian and military witnesses in the area were debriefed, and news reporters were given the effective cover story that the object had been a misguided weather research balloon.

c. There is a possibility that some of the incidents may be caused by natural phenomena, such as meteors.

d. The reported operating characteristics such as extreme rates of climb, maneuverability (particularly in roll), and action which must be considered evasive when sighted or contacted by friendly aircraft and radar, lend belief to the possibility that some of the objects are controlled either manually, automatically or remotely.

e. The apparent common description of the objects is as follows:-

- (1) Metallic or light reflecting surface.

~~SECRET~~

U-39592

~~SECRET~~

Basic Ltr fr CG, AMC, WF to CG, AAF, Wash. D. C. subj "AMC Opinion Concerning "Flying Discs".

- (2) Absence of trail, except in a few instances when the object apparently was operating under high performance conditions.
- (3) Circular or elliptical in shape, flat on bottom and domed on top.
- (4) Several reports of well kept formation flights varying from three to nine objects.
- (5) Normally no associated sound, except in three instances a substantial rumbling roar was noted.
- (6) Level flight speeds normally above 300 knots are estimated.

f. It is possible within the present U. S. knowledge -- provided extensive detailed development is undertaken -- to construct a piloted aircraft which has the general description of the object in subparagraph (e) above which would be capable of an approximate range of 7000 miles at subsonic speeds.

g. Any developments in this country along the lines indicated would be extremely expensive, time consuming and at the considerable expense of current projects and therefore, if directed, should be set up independently of existing projects.

h. Due consideration must be given the following:-

- (1) The possibility that these objects are of domestic origin - the product of some high security project not known to JC/AS-2 or this Command.
- (2) The lack of physical evidence in the shape of crash recovered exhibits which would undeniably prove the existence of these objects.
- (3) The possibility that some foreign nation has a form of propulsion possibly nuclear, which is outside of our domestic knowledge.

3. It is recommended that:

a. Headquarters, Army Air Forces issue a directive assigning a priority, security classification and Code Name for a detailed study of this matter to include the preparation of complete sets of all available and pertinent data which will then be made available to the Army, Navy, Atomic Energy Commission, JEDS, the Air Force Scientific Advisory Group, NACA, and the RAND and NEPA projects for comments and recommendations, with a preliminary report to be forwarded within 15 days of receipt of the data and a detailed report thereafter every 30 days as the investi-

~~SECRET~~

-2-

U-39592

~~SECRET~~

Basic Ltr fr CG, AMC, WF to CG, AAF, Wash. D.C. subj "AMC Opinion Concerning "Flying Discs"

gation develops. A complete interchange of data should be effected.

4. Awaiting a specific directive AMC will continue the investigation within its current resources in order to more closely define the nature of the phenomenon. Detailed Essential Elements of Information will be formulated immediately for transmittal thru channels.

*M. F. Twining*  
M. F. TWINING  
Lieutenant General, U.S.A.  
Commanding

COPY



A Polish-language map of Nazi enclaves in South America, particularly Argentina. It is thought that some of the UFO activity in South America came from German saucers relocated to remote parts of that continent.

[Index](#)

## CHAPTER EIGHT: CONCLUDING THOUGHTS

What can be concluded from this glimpse into the world of German flying discs? Certainly, it can be said that some of these projects were realized. This being true, it can be said that these were the first "flying saucers". It is also certainly true that German flying discs were re-created and perhaps further developed by countries comprising the former Allied Powers. It can be said that in all probability, Germans immigrated to places outside Europe after the war and also built these flying craft. It is also a certainty that the exact nature and real history of these flying devices has remained a closely guarded secret in all these countries. Not only has a secret been kept but an active effort, a conspiracy, has been made to keep it that way. This means that there exists an effort to keep the exact knowledge of these devices from the general populace for the foreseeable future. This effort extends back into time, into the origins of these projects in Germany and extends into the present. The victors wrote history. The victors omitted German flying discs and the victors are keeping quiet now.

The exact methods of propulsion of the exotic versions of these discs still remains a mystery. Jet and rocket engines were used but there is still debate as to which models used which engine at what time. There is no doubt in my mind that field propulsion techniques were at least experimented upon during the 3rd Reich. This is established in my mind, if for no other reason, by the series of F.B.I. reports dealing with the witness who saw such a device while a prisoner of war near Gut Alte Gossen. The F.B.I. took these reports seriously enough to take them and save them all these years. Maybe we should also.

One overriding question concerning UFOs is why are they so, so secret? Dr. Milos Jesensky and engineer Robert Lesmakiewicz propose an atomic saucer in their book "Wunderland" Mimoszemské Technoloaie Treti Rise. This conclusion is seconded by Klaus- Peter Rothkugel and Jim Wilson. This assertion should be taken very seriously.

The UFO-atomic connection fits the historical facts concerning both atomic energy and UFOs. UFOs have always been and are today associated with atomic energy facilities. Los Alamos, Hanford and Area 51 are examples of nuclear facilities at which or very near to which UFOs are or were regularly seen. If we suppose atomic energy as a power source it might explain this association. But that can not be all there is to this matter. Methods of propulsion involving atomic energy seem to be known to us. Indeed, some were reviewed in this book. Why the extreme secrecy then? Might it be that there is some other arrangement involving nuclear energy of which we know nothing? Might the Germans have stumbled on to something really exciting during those war years, perhaps coupling field propulsion with atomic energy? If this is so then not only would the association of UFO activity over and near nuclear facilities be explained but some of the extreme secrecy and conspiracy to cover-up the matter might also be explained.

At this point the reader may smiling and shaking his or her head in disbelief, perhaps even making comments involving the words "fantasy" or "science fiction". The German watch-word of those times was "nothing is impossible" and it is clear that within the Reich scientists took this saying to heart. Those scientists were not surprised by breakthroughs, they expected them. Please let me remind the reader that the alternative explanation is ethereal science fiction or fantasy. In this origin of UFOs a multitude of alien beings seemingly travel to earth from intergalactic space not to exchange ideas, exploit earth's resources or conquer the planet, but to abduct and inseminate our females. And above all, if we buy into this reasoning, these aliens seem particularly attracted to American women.

The story goes on from here to describe genetic experiments, mixing the DNA of humans and aliens to produce a hybrid human-alien. Anybody who entertains such nonsense has absolutely no understanding of the species concept in biology. Unfortunately, many individuals subscribing to the alien hypothesis fall into this category, even some with advanced degrees. Only one of two possibilities are within reason. The first is that these hominids are manifested in the minds of the witnesses as the result of some black mind control project sponsored by the government. The second possibility is that they are the result of experimentation by the government involving human, hominid or hominid genes. Either option is possible but both options are beyond the scope of this book. Both discussions are superfluous, however, since the topic of this book is UFOs, not aliens. "Aliens" have been used by the media and the government long enough to misdirect the inquiry into UFOs. Aliens are the ultimate "red herring".

In trying to crystallize these thoughts on the origin of UFOs, we are presented with two mutually exclusive hypotheses for the origin of flying saucers. The first is that they are a man-made technology. The second is that they are a non-man-made technology. In view of the fact that we now know the first scenario is true, why are we even considering holding on to the second hypothesis? There is no reason for a duplicity of theory. If a failure to explain the facts is ever encountered in the "UFOs are man-made theory", then and only then are we justified in moving to another hypothesis.

Before signing off it is felt that an obligation exists to discuss another reason for the suppression of the German connection in the history of UFOs. English speakers sometimes recognize this as an unuttered truth once it is out in the open but many German speakers and others are usually well ahead of the curve on this one. Unfortunately, this is not going to be pleasant.

In some circles, the flying discs built by the Germans during the war are called "Nazi UFOs". Some may do this as a way to quickly name a concept but some others do this for an entirely different reason. The point that is being made is that technology usually does not adopt a political name. The atomic bomb dropped on the Japanese by the Americans was not called the "Democrat Bomb", for example, even though a Democrat was in power in the United States at the time. The Nazis are a special case, however, and this is a central problem and roadblock we encounter in researching their innovations.

The Nazis were defeated militarily by the Allies. Yet some in the media elite continue to fight this war. Of course, the Allies always win but that is not the purpose of their fight. The purpose is the nature of the Nazis themselves. The Nazis were not just a military machine. Hitler and his supporters brought other ideas with them into power. These ideas were historical, social, artistic, economic and scientific. In other words, the Nazis brought a completely new culture into prominence almost overnight and with at least the passive acceptance of most of the general populace.

It is sometimes said by these media people in question that America defines itself as what the Nazis were not. The fascination that the mass media, especially in Hollywood, has for the Nazis is evidenced in their ongoing campaign to insure that these cultural ideas are as thoroughly defeated as the Nazi military. In defeating the Nazis militarily on the silver screen they believe they also defeat the cultural ideas associated with the Nazis. They take every opportunity to do this. The media fight this propaganda war over and over again, as if the war was still going on, while attempting to link the military defeat of the Nazis with the cultural defeat of their ideas.

For a moment I want to digress in order to illustrate an example of exactly what I am talking about. This example is both germane to our discussion of UFOs as well as cutting to the very heart of this cultural conflict. It has to do with Hitler's myrmidons, the SS.

Historians tell us that the abbreviation "SS" stands for "Schutzstaffel". "Schutzstaffel" could be thought of as "bodyguard" and in the early days of the Nazi movement members of this order dressed in black and were Hitler's personal bodyguard. As it developed, this order changed into many things.

Portrayal of the SS in the media has degenerated simply into a negative caricature to which we are all supposed to respond immediately with a politically correct, knee-jerk type of condemnation formula. As far as the media is concerned, this is all the SS was. Their point is that we now know enough about the SS and are supposed to drop further inquiry. This first unwritten law has already been violated in this book. In this discussion we have focused on the SS as the organizational and in some cases the research and development framework behind German super-weapon's technology. But the SS was more than this. To insiders, initiates within the 3rd Reich, the abbreviation "SS" did not stand for "Schutzstaffel" at all but for the words "Schwarze Sonne".

"Schwarze Sonne" means "Black Sun" in English. The Black Sun to these initiated individuals was a physical body like our visible sun except that the Black Sun was not visible to the naked eye. This Black Sun radiated light which was invisible to the human eye. The concept of the Black Sun seems to have bordered upon the religious. It was said to be located at the center of our galaxy. The earth along with every other celestial body in the galaxy rotate around this Black Sun.

The Black Sun is sometimes represented symbolically as a black sphere out of which eight arms extend. Such is its most famous rendition on the mosaic floor at Wewelsburg Castle which served as the spiritual home of the SS. The number of arms are unimportant. There could be eight or six or only four. The more astute reader will recognize at this point that the swastika, thievery icon of the Nazi Party, was itself is a Black Sun symbol.

The point is that concept of the Black Sun is not just Nazi mumbo-jumbo. The Black Sun is in reality a cold, collapsing implosive vortex as described by Viktor Schauberger or Karl Schappeller. It gathers and densities yet is as cold as interstellar space. It does generate unseen radiation in the form of cosmic, gamma and x-ray radiation. This is possible because in spite of what was said about those crazy "Nazi madmen", the Black Sun is very real. In fact, the Black Sun is the most powerful force yet observed in our universe.

Forty or so years after the demise of the SS, scientists, in this case astronomers, have located the Black Sun at the very center of our galaxy. In fact, we are all familiar with it by another name. Today, we call it a "black hole". It is the center of great spiral vortex of stars which draws in matter and energy and generates the aforementioned radiations near its periphery. The Black Sun is, in reality, a huge system or perhaps it could even be called a huge machine. We and our entire galaxy are all part of this machine whirling through space. All the matter it contains, the stars, planets, asteroids, comets, meteors and so forth, are all bound in a context of energy. Our galaxy, with the Black Sun as its heart, operates as a vast machine using all the matter and energy contained therein and using every law of physics at once in its operation. Its counterpart, the centrifugal vortex which remains unseen, may even be a doorway into another dimension



into which this matter and energy from our dimension spew forth like a fountain. It is the same kind of implosive vortex from which the Germans were about to build a "new science" based upon creative, living energy as we have discussed. It may have been the same force which was to propel their flying discs.

Yet who in the media would dare give credit to those associated with the 3rd Reich for making these connections so long ago? In fact, who in the media would even point out this connection today? None. As far as they are concerned, one is politically incorrect to ever say or imply that the Nazis thought of or developed anything of value. To do so would be to commit professional suicide. To do so would mean the end of one's career whether in the business or the academic world. Even if one wanted to make this connection in print or film form, no politically correct publisher or producer would touch it, at least in English.

Not only does the media fail to give credit where credit is due, or to even mention or explain this concept, but anyone seeking to look into such concepts runs the real risk of being branded anew-Nazi. This threat clearly extends into the UFO world. As a result, this threat has had a chilling effect on real UFO inquiry for over fifty years.

How should the media be treated in this case? How are we going to handle institutions within our culture which actively seek to stymie knowledge? Regardless of one's personal opinion of the Nazis, should we and are we going to allow these "open-minded champions of truth" the right to omit the history of UFOs, let alone the new science of this force of nature, simply because "they" find its origin politically offensive?

Returning from this example to our broader discussion of the media, in American culture it is sometimes said that the media's power rivals or exceeds that of the three branches of American government. With power such as this, the media believes itself up to any propaganda challenge. They are correct in this belief. As any thoughtful person realizes, the mass media's power has been used frequently in the last forty years to radically alter the course of those three branches of government.

In addition to the above referenced dilemma regarding media bias, we face a second obstacle in any effort to arrive at the truth. It is a culture of secrecy within the government itself. Vesco recognized this immediately. According to this "Vesco Doctrine" no German secret was acknowledged publicly unless that secret fell into the hands of more than one of the four occupying powers, (USA, Soviet Union, Great Britain, France). He says: "In fact, of the numerous revolutionary "new weapons" that the Germans developed in that period, we know only those—fortunately, they comprise the majority—that fell into the hands of all, or at least more than one, of the four occupying powers"(1).

These governments seem to keep secrets for the sake of keeping secrets. In any event, they operate on a "need to know" basis in dispensing these secrets. We simply have no need to know in their eyes.

The differences between the media and the government itself are becoming more and more blurred. Politicians rely on instant polls, conducted the night before by the media, to plot today's public policy. The results of these polls are whatever the media says they are. In the meantime, the media itself is doing everything it can through "news", through entertainment and through movies to influence the results of those polls. The media and the government are so closely intertwined that for all practical purposes they can be considered as one. The C.I.A. spends a large portion of its budget in an effort to frame public discussion on issues it deems sensitive. The point here is that "truth" is not the goal of the government and in accomplishing their ends they use the methods of the mass media if they are not in partnership with the mass media itself.

For almost sixty years this government/media has been telling us through their propaganda machine, "Hollywood", that all the ideas of the Nazis were meritless, if not dangerous. "The Nazis never had a good idea" seems to be their simplistic mantra. Of course government, at some level, knows what you now know about the origins of UFOs. In fact, they know that there is much more to this still-secret high technology than just UFOs. In the past, they have no trouble using captured German scientists when it is in their interest to do so, but they hate to admit it. The problem they face is that they have boxed themselves in a corner. They can not admit the origins of UFO technology without a re-appraisal of other ideas which they have succeeded in putting to bed. If they were to admit one good "Nazi" idea, the question might arise as to if there is another good idea. The elite media has already preempted this question rhetorically, calling any re-appraisal of the Second World War "Revisionism". They use this word disparagingly. Using a sort of "new-speak" they have kept the genie bottled up for almost sixty years.

What does this all mean to the researcher or truth seeker? With enough evidence could this information ever be acknowledged officially? With what level of proof could this elite media/government power axis acknowledge the fact that Germans working for Hitler built experimental flying craft that we could not even touch? The simple answer is that they

can not do so,period. Not with "all the proof in the world". Why should they? What is the upside for them? There are no good Nazi ideas. There is no need to know. There is perhaps a technological breakthrough behind the mystery. This is a loose-loose-loose situation for them by any reckoning.

Perhaps we can crystallize this nightmare for the power elite in an image. Suppose that tomorrow a highly technically advanced flying saucer landed on the White House steps in front of full, live, media coverage. Their nightmare would not be a little greyalien emerging from the saucer saying: "Take me to your leader". Their nightmare would be a former SS scientist emerging from the flying saucer saying: "I have an appointment".

The implications are obvious. For over forty years the UFO community has been saying that we are on the verge of full government UFO disclosure. For the reasons outlined above, we are not now nor will we ever be on the verge of full UFO disclosure by the government.

This means that it is up to us to do the "disclosure". Anyone interested in doing research along these lines will be encouraged to know that there is plenty of room in this field. It is not necessary to be a scientist. It is not necessary to live in Europe. It is not necessary to read German. The most important ingredient in this research is interest. If you are interested, there are mountains of government files which remain unexplored. The censors did not edit-out everything. They made mistakes which can be caught and pieced together. If each researcher could contribute just one fact to this growing body of knowledge, our trouble would be over quickly. In short, "Disclosure" isn't going to happen unless we make it happen.

These scientists and technicians who built these early flying saucers may have been the very best and brightest of their time but they got up each morning and put their pants on just like the rest of us. In fact, they are us. Now that we know that we earthlings are capable of manufacturing objects we call UFOs, should we not use these facts we possess in explaining this phenomena rather than ignoring this information altogether? Should we not cease creating a new and superfluous mythology, if not an outright religion, to explain this phenomena which is completely devoid of a factual basis? Real truth is usually quite simple. In this case the real truth is that the origin of UFOs and many more technological secrets are resting in the grave of Nazi Germany, simply awaiting our re-discovery.

This has not been "The Complete Book of UFOs" or even "The Complete Book of German Flying Discs". Within each topic touched upon in this book lie worlds within worlds of details and additional information. It is for the reader to use the references cited as a starting point to root out what is of interest. This book was designed to get you started. It was only a guide.

## **Concluding Thoughts-References**

Vesco, Renato, 1976, Intercept UFO, page 96, Pinnacle Books, New York, NY.

## **THANKS**

Most everyone who has ever looked in to the matter of German flying discs has come to the conclusion that there is at least some truth to it. Still, opinions and interpretations within this group differ with the individual doing the research. Nobody can know or find everything. This certainly is true of the study of German flying discs. Many researchers in this field have setup a circle of correspondence or exchange with others interested in this topic. Even the brightest, most hard working individuals have benefited from an exchange of information.

I have written up this book by doing some research and receiving a great deal of help, input and information sent to me by my friends. My deepest thanks and appreciation go out to those individuals who have shared their findings with me, explained their research to me and/or shared the counsel of their wisdom. This is true even in cases of disagreement or in cases of differing interpretations. In all cases, they have gone much beyond their published material. These include: Michael Blaeser, Rainer Daehnhardt, the late Joseph Andreas Epp, Dr. Gordon Freeman, Heiner Gehring, Friedrich Georg, Dr. Milos Jesensky, Kadmon, Mark Kneipp, Robert Lesniakiewicz, William Lyne, Thomas Mehner, Theo Paymans, Richard Ross, Klaus-Peter Rothkugel, Horst Schuppmann, Vladimir Terziski, Milos Vnenk and Michael Watson. I would also like to thank my daughter, Lisa Stevens, for her work in proof reading and editing this text.

What the American Government Really Thought About UFOs

SECRET

1 JAN 1952



DEPARTMENT OF THE AIR FORCE  
HEADQUARTERS UNITED STATES AIR FORCE  
WASHINGTON 25, D. C.

1 JAN 1952

AFOPD-4

MEMORANDUM FOR FEDERAL BUREAU OF INVESTIGATION

SUBJECT: (SECRET) Contemplated Action to Determine the Nature and Origin of the Phenomena Connected with the Reports of Unusual Flying Objects

1. The continued reports of unusual flying objects requires positive action to determine the nature and origin of this phenomena. The action taken thus far has been designed to track down and evaluate reports from casual observers throughout the country. Thus far, this action has produced results of doubtful value and the uncertainties inherent in the nature of the reports has given neither positive nor negative proof of the claims.

2. It is logical to relate the reported sightings to the known development of aircraft, jet propulsion, rockets and range extension capabilities in Germany and the U.S.S.R. In this connection, it is to be noted that certain developments by the Germans, particularly the Horton wing, jet propulsion, and refueling, combined with their extensive employment of V-1 and V-2 weapons during World War II, lend credence to the possibility that the flying objects may be of German and Russian origin. The developments mentioned above were completed and operational between 1941 and 1944 and subsequently fell into the hands of the Soviets at the end of the war. There is evidence that the Germans were working on these projects as far back as 1931 to 1938. Therefore, it may be assumed that the Germans had at least a 7 to 10 year lead over the United States in the development of rockets, jet engines, and aircraft of the Horton-wing design. The Air Corps developed refueling experimentally as early as 1928, but did not develop operational capability until 1948.

3. In view of the above facts and the persistent reports of unusual flying objects over parts of the United States, particularly the east and west coast and in the vicinity of the atomic energy production and testing facilities, it is apparent that positive action must be taken to determine the nature of the objects and, if possible, their origin. Since it is known fact that the Soviets did not detonate an atomic bomb prior to 1949, it is believed possible that the Soviets may have developed the German aircraft designs at an accelerated rate in order to have a suitable carrier for the delivery of weapons of mass destruction. In other words, the Soviets may have a carrier without the weapons required while we have relatively superior weapons with relatively inferior carriers available. If the Soviets should get the carrier and the weapon, combined with adequate defensive aircraft, they might surpass us technologically for a sufficient period of time to permit them to execute a decisive air campaign against the United States and her allies. The basic philosophy of the Soviets has been to surpass the western powers technologically and the Germans have given them the opportunity.

4. In view of the facts outlined above, it is considered mandatory that the Air Force take positive action as soon as definitely determine the nature and, if possible, the origin of the reported unusual flying objects. The following action is now contemplated:

- a. to require AFSC to provide at least three teams to be matched up with an equal number of teams from ADG for the purpose of taking radar scope photographs and visual photographs of the phenomena;
- b. to select sites for these teams, based on the concentrations of already reported sightings over the United States; (these areas are, generally, the Seattle area, the Albuquerque area, and the New York-Philadelphia area) and
- c. to take the initial steps in this project during early January 1952.

1 Incl  
Tech. Rept #16-45

*W. M. Garland*  
W. M. GARLAND  
Brigadier General, USAF  
Assistant for Production  
Directorate of Intelligence

copy - 1 - High School

Left, U.S. Air Force document, Jan. 3, 1952 Right, blowup of the second paragraph

[Index](#)

# German Moon Base

from [VJEnterprise](#) Website

Following the belief that the Germans had gained advanced technologies in the early 1940's (possibly from recovered crashed UFOs or through contact with an alien culture), this article by Vladimir Terziski, President of the American Academy of Dissident Sciences, is a study of the Germans involvement in the exploration of the Moon and Mars.

## SIAM

For all further inquiries, list of publications and videos, available from the Academy, please write to me at the following address:

**Vladimir Terziski,**  
President,- American Academy of Dissident Sciences,  
10970 Ashton Ave. #310, Los Angeles, CA 90024,  
phone and fax: USA-(310)-473-9717.

## HALF A CENTURY OF THE GERMAN MOON BASE

( 1942 - 1992 )

**From:** rkrouse@netcom.com (Robert K. Rouse)  
**Newsgroups:** alt.paranet.ufo,alt.alien.visitors,alt.conspiracy  
**Subject:** Moon and Mars Bases  
**Date:** 24 Aug 93 16:20:45 GMT

The Germans landed on the Moon as early as probably 1942, utilizing their larger exo-atmospheric rocket saucers of the Miethe and Schriever type. The Miethe rocket craft was built in diameters of 15 and 50 meters, and the Schriever Walter turbine powered craft was designed as an interplanetary exploration vehicle. It had a diameter of 60 meters, had 10 stories of crew compartments, and stood 45 meters high.

Welcome to Alice in Saucerland. In my extensive research of dissident American theories about the physical conditions on the Moon I have proved beyond the shadow of a doubt that there is atmosphere, water and vegetation on the Moon, and that man does not need a space suit to walk on the Moon. A pair of jeans, a pullover and sneakers are just about enough.

Everything **NASA** has told the world about the Moon is a lie and it was done to keep the exclusivity of the club from joinings by the third world countries. All these physical conditions make it a lot more easier to build a Moon base.

Ever since their first day of landing on the Moon, the Germans started boring - and tunneling under the surface, and by the end of the war there was a small Nazi research base on the Moon. The free energy tachyon drive craft of the [Haunebu-1 and 2 type](#) were used after 1944 to haul people, materiel and the first robots to the construction site on the Moon.

When Russians and Americans secretly landed jointly on the Moon in the early fifties with their own saucers, they spent their first night there as guests of the .... Nazi underground base. In the sixties a massive Russian - American base had been built on the Moon, that now has a population of 40,000 people, as the rumor goes.

After the end of the war in May 1945, the Germans continued their space effort from their south polar colony of [Neu Schwabenland](#). I have discovered a photograph of their underground space control center there.

---

## GERMAN-JAPANESE MILITARY R&D COOPERATION:

According to **Renato Vesco** again, Germany was sharing a great deal of the advances in weaponry with their allies the Italians during the war. At the Fiat experimental facility at lake La Garda, a facility that fittingly bore the name of air martial [Hermann Goering](#), the Italians were experimenting with numerous advanced weapons, rockets and airplanes, created in Germany.

In a similar fashion, the Germans kept a close contact with the Japanese military establishment and were supplying it with many advanced weapons. I have discovered for example a photo of a copy of the manned version of the V-1 - the Reichenberg - produced in Japan by Mitsubishi. The best fighter in the world - the push-pull twin propeller Domier-335 was duplicated at the Kawashima works. Or a photo of Japanese high ranking Imperial navy officers inspecting the latest German radar station.

A Japanese friend of mine in Los Angeles related to me the story of his friend's father, who worked as technician in an aircraft research bureau in Japan during the war. In July of 1945, two and a half

months after the war ended in Germany, a huge German transport submarine brought to Japan the latest of German inventions - two spherical wingless flying devices.

The Japanese R&D team put the machines together, following the German instructions, and... there was something very bizarre and other-earthly standing in front of them - a ball shaped flying device without wings or propellers, that nobody knew how it flew. The fuel was added, the start button of this unmanned machine was pressed and it .... disappeared with a roar and flames without a in the sky. The team never saw it again.

The engineers were so frightened by the unexpected might of the machine, that they promptly dynamited the second prototype and choose to forget the whole incident.

---

## **GERMAN-JAPANESE FLIGHT TO THE MOON AND MARS IN 1945-46:**

According to the authors of the underground German documentary movie from [the Thule society](#), the only produced craft of the Haunebu-3 type - the 74 meter diameter naval warfare dreadnought - was chosen for the most courageous mission of this whole century - the trip to Mars.

The craft was of saucer shape, had the bigger Andromeda tachyon drives, and was armed with four triple gun turrets of large naval caliber (three inverted upside down and attached to the underside of the craft, and the fourth on top of the crew compartments).

A volunteer suicide crew of Germans and Japanese was chosen, because everybody knew that this journey was a one-way journey with no return. The large intensity of the electro-magnetogravitic fields and the inferior quality of the metal alloys used then for the structural elements of the drive, was causing the metal to fatigue and get very brittle only after a few months of work of the drive. The flight to Mars departed from Germany one month before the war ended - in April 1945.

It was probably a large crew, numbering in the hundreds, because of the low level of automation and electronic controls inside the saucer. Most of the systems of the craft had to be operated like these on a U-boat of that time - manually. Because the structurally weakened tachyon drives were not working with full power and not all the time, the trip to Mars took almost 8 months to accomplish.

An initial short trust towards Mars was probably used the strong gravitational field close to Earth, after that the craft was "coasting" for 8 months in an elliptical orbit to Mars with its main drives turned off. Later trips to Mars by the joint [Soviet-American craft](#) in 1952 and by [the Vatican craft](#) of the Marconi project from Argentina in 1956 reached Mars in only 2 - 3 days, because their drives were working during the whole flight: accelerating in the first half and decelerating in the second.

Smaller *Kohler converters* were probably used to power the systems and life support equipment on board. I do not have any information at the present time about any artificial gravity capability on board the craft, but that could have been easily done with the large antigravity drives of the ship.

After a heavy, almost crashing landing, the saucer slammed to a stop, damaging irreparably its drives, but saving the crew. That happened in the middle of January 1946. The crash landing on Mars was not only due to the crippled tachyon drives of the craft - it was also due to the smaller gravitational field of Mars generating less power for the tachyon drives; and also due to the thinner atmosphere on Mars, that could not be used as effectively for air breaking as the Earth's atmosphere could.

The craft was shaped as a giant saucer - a form that is very efficient as an air brake, when it is entered into the atmosphere with its huge cross section perpendicular to the trajectory of descent.

One question, that I have not answered yet in the affirmative is how were the Germans able to regenerate the air inside the craft for 8 months for this big crew. Quite probably they were using advanced life support systems, developed initially for their larger Walter turbine and free energy submarines, that were cruising the oceans without resurfacing.

The radio message with the mixed news was received by the German underground space control center in [Neu Schwabenland](#) and by their research base on the Moon.

**Return to La Luna  
Return to German Disc Aircrafts**

1942-1992  
Half A Century of...  
**The German Moon Base**

by Vladimir Terziski  
President of the American Academy of Dissident Sciences

from [GreyFalcon](#) Website

## **German Moon Base Alpha**

The Germans landed on the Moon as early as probably 1942, utilizing their larger exo-atmospheric rocket saucers of the Miethe and Schriever type.

The *Miethe rocket craft* was built in diameters of 15 and 50 meters, and the *Schriever Walter turbine powered craft* was designed as an interplanetary exploration vehicle.

It had a diameter of 60 meters, had 10 stories of crew compartments, and stood 45 meters high.



**Germans had gained advanced technologies in the early 1940's**

**(possibly from recovered crashed UFOs or through contact with an alien culture)**

**This article by Vladimir Terziski, President of the American Academy of Dissident Sciences,  
is a study of the Germans involvement in the exploration of the Moon and Mars.**

In my extensive research of dissident American theories about the physical conditions on the Moon I have proved beyond the shadow of a doubt that there is atmosphere, water and vegetation on the Moon, and that man does not need a space suit to walk on the Moon.

A pair of jeans, a pullover and sneakers are just about enough. Everything NASA has told the world about the Moon is a lie and it was done to keep the exclusivity of the club from joinings by the third world countries. All these physical conditions make it a lot more easier to build a Moon base.

Ever since their first day of landing on the Moon, the Germans started boring and tunneling under the surface, and by the end of the war there was a small Nazi research base on the Moon. The free energy tachyon drive craft of the Haunebu-1 and 2 type were used after 1944 to haul people, " materiel and the first robots to the construction site on the Moon.

When Russians and Americans secretly landed jointly on the Moon in the early fifties with their own saucers, they spent their first night there as guests of the.... Nazi underground base. In the sixties a massive Russian - American base had been built on the Moon, that now has a population of 40,000 people, as the rumor goes.

After the end of the war in May 1945, the Germans continued their space effort from their [south polar colony of Neu Schwabenland](#).

I have discovered a photograph of their underground space control centre there.

## **GERMAN-JAPANESE MILITARY R&D COOPERATION**

According to **Renato Vesco** again, Germany was sharing a great deal of the advances in weaponry with their allies the Italians during the war.

At the Fiat experimental facility at lake Garda, a facility that fittingly bore the name of Air Marshall **Hermann Göring**, the Italians were experimenting with numerous advanced weapons, rockets and airplanes, created in Germany.

In a similar fashion, the Germans kept a close contact with the Japanese military establishment and were supplying it with many advanced weapons.

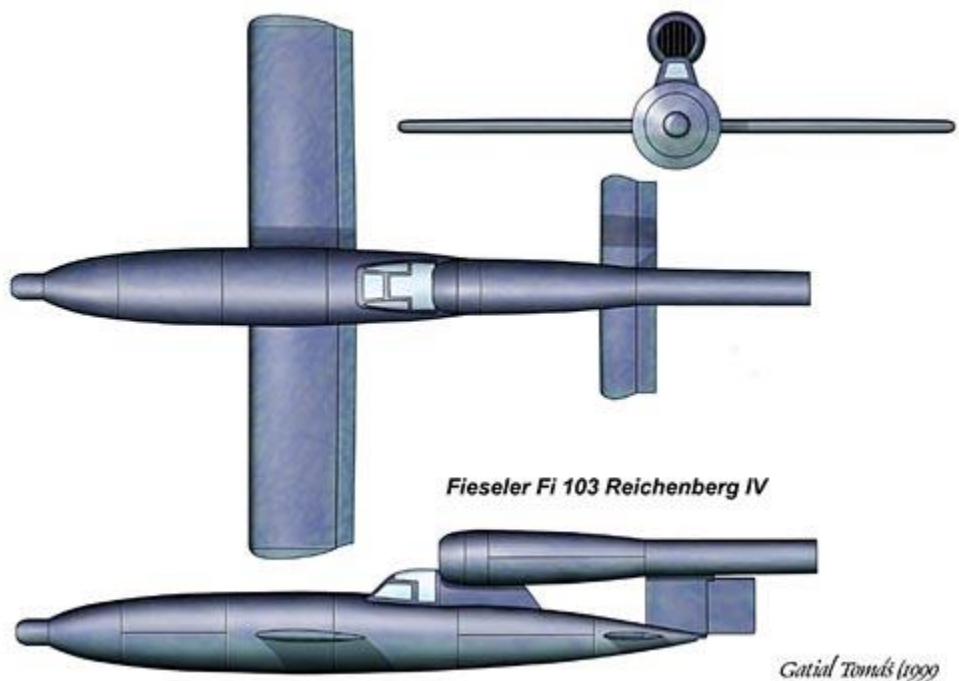

I have discovered for example a photo of a copy of the manned version of the V-1 - the Reichenberg - produced in Japan by Mitsubishi.

The best fighter in the world - the push-pull twin propeller Domier-335 was duplicated at the Kawashima works. Or a photo of Japanese high ranking Imperial navy officers inspecting the latest German radar station.

A Japanese friend of mine in Los Angeles related to me the story of his friend's father, who worked as technician in an aircraft research bureau in Japan during the war.

In July of 1945, two and a half months after the war ended in Germany, a huge German transport submarine brought to Japan the latest of German inventions - *two spherical wingless flying devices*. The Japanese R&D (*research and develop*) team put the machines together, following the German instructions, and... there was something very bizarre and other-earthly standing in front of them - a ball shaped flying device without wings or propellers, that nobody knew how it flew.

The fuel was added, the start button of this unmanned machine was pressed and it.... disappeared with a roar and flames without a sign in the sky. The team never saw it again.

The engineers were so frightened by the unexpected might of the machine, that they promptly dynamited the second prototype and choose to forget the whole incident.

## **Japanese Wonder Weaponry created in conjunction with Germany Foo-Fighters (Feuerball) artifacts**

These are remote-controlled spheres which are sent against the enemy with supposed electromagnetic effects in aircraft or simple psychological weapons for frightening enemy pilots.



Weapon identified as [AEG Kugelwaffen](#) sent to Japan via submarine and long-range aircraft technology transfers. Several of the Kugelwaffen are seen trailing Sally bombers with the gunners making no attempt to shoot them down, suggesting they were being tested.

Encountered in the Pacific after Germany surrendered, the 20th and 21st BGs reported these weapons in over 300 sightings.

### Disc-shaped or cylindrical air vehicles

Cylindrical or disc-shaped aircraft with advanced engines that Germany sent to Japan in the last days of the war, again by submarine technology transfer.

Type of discs sent supposedly WNF Feuerball type. No Vril or Haunebu Type would fit in any of the German submarines and the Germans were not likely to share any of the occult SS E-IV Technical Branch knowledge as those discs were being moved to South America and *Base 211 in Neu Schwabenland, Antarctica* from Mar-Apr 1945 for continued postwar development.

In the Antarctic area there was a supposed technical exchange of Japanese Sub Type I-400/M6A1 Seiran bombers with the Germans for other military technology that they gave to the Japanese.

Base 211 was constructed between 1941-43 in the Muhlig-Hoffman mountains.

["Neu-Schwabenland"](#) underground complex with "Neu Berlin" as capital of surviving Reich led by [SS General Hans Kammler](#). There is ample evidence of construction of this base with German surface raiders and U-boats making continuous journeys to the South Atlantic, Argentina's Tierra del Fuego (Fire Island), and Antarctic waters. The Germans set up meteorological bouys and weather stations from Antarctica all the way up to the Patagonia region of Argentina.

[Grossadmiral Karl Dönitz](#) kept a large number of U-boats in the South Atlantic despite the raging war in the North Atlantic and it was Dönitz who became the second Führer of European Germany, Neu Schwabenland having never surrendered. Both the US and UK established presences in Antarctica during the war and some Germans were captured on the Falkland Islands (Islas Malvinas).

Argentina made their Antarctic claim the same year as Base 211 became operational-1943 and aided the Nazis against US and other South American national pressure. In March 1945, the US finally pressured Argentina to declare war on Germany and Japan but to no avail. The Perons sheltered the Nazis and let Odessa ferret war criminals into Argentina postwar.

Argentine naval records report unusual disc craft operating off their coast during and after the war, BEFORE the US 1947 UFO sightings began ironically where German weapons were being tested in New Mexico.

### Sonic, wind and ray weapons

Other strange types of weapons used sounds, used the wind, or shot energy rays, respectively.

They are similar to the [Windkanone](#) (Windcannon), [Schallkanone](#) (Soundcannon), [Donar Kraftstrahlkanone](#) (Power Ray Cannon). Germany supposedly sent many plans over these artifacts, but no information exists indicating that any of these were constructed in the last days of the conflict. However, the Captain of [U-977 that surrendered in Argentina](#) months after Germany's capitulation revealed in his book, "U-977" that the Japanese delegations sent to Berlin observed the SS death rays (crude microwave weapons) in 1945.

### Japanese-German Space programs

Supposedly, Germany previously and during the war developed a SS space program (Raumflug), which included specialists from the Japanese Army and Navy. No confirmation of this exists.

## Joint Programs

- Japanese-German Lunar Station Alpha-1, the alleged lunar base station constructed by the Nazis in 1943–1945.
- Japanese-German suicide space mission to the planet Mars in April–May 1945, using the Haunebu III space vehicle modified with long range capacity.

With respect to all this, there exist only some references or memories of some Japanese researchers who supposedly worked on some assignments over these technologies, but no real evidence about them exists.

One of these references is about an ancient technician of the Mitsubishi company who remembers a strange cylindrical or spherical artifact acquired from a German submarine in the last days of the conflict. The Japanese armed one of these two examples (very similar to the German "Feuerball" objects) but found it very hard to control.

The Japanese were highly superstitious and could not conceive of the type of invisible propulsion system that these objects operated by; subsequently they were associated with demons and dynamited in a pit after Japan officially surrendered.

Other references about these weapons are the encounter of a Japanese Navy Mitsubishi A6M Zero with a Disc over Genzan (Chosen) and the reports of B-29 pilots in Marianas and Japan of some Spheres of Light (Foo-Fighters) in the last days of the war.

Both Nakajima and Mitsubishi are suspected of having tried to construct purely Japanese discs during the war, exemplified by the 1942 "Battle for L.A." disc that was fired upon to no effect. Recent analysis of the photos reveals a disc design different than that of the Germans, same for the 1942 sighting of a strange disc over Hopeh Province in China.

These supposed Japanese discs had one thing in common- they were quite slow and tended to fly in a straight flight path. German discs by comparison were running off powerful EMG engines capable of speeds of well over 7,000 km/h and were heat-shielded by a metal called Viktalen. Some call this "Frozen Smoke".

A Bulgarian researcher, **Vladimir Terzinsky**, investigated the German-Japanese Space program and its connections with Military technical collaboration.

For example, he spoke about the [Fieseler Fi-103 \(V1\)](#) and [Dornier Do 335 Pfeil](#) and the Japanese developed Kawanishi Baika suicide pulsejet plane and the Kawanishi J1W1 Shinden interceptor.

During a routine inspection of the Japanese merchant vessel Asama Maru on January 21, 1940, in the Indian Ocean, officers of the British cruiser HMS Liverpool discovered twenty-one German civilians on board. All were highly qualified technicians being sent to Japan to service German surface raiders and U-boats soon to be operating in the Pacific area. The technicians were removed and interned as prisoners-of-war but as Britain was not at war with Japan at this time the Asama Maru was allowed to proceed to her destination. Some weeks later, on February 29th, Britain handed back nine of the technicians to Japan after Japan agrees not to send them back to their homeland.

## **GERMAN-JAPANESE FLIGHT TO THE MOON AND MARS IN 1945-46**

According to the authors of the underground German documentary movie from the [Thule society](#), the only produced craft of the Haunibu-3 type - the 74 meter diameter naval warfare dreadnought - was chosen for the most courageous mission of this whole century - the trip to Mars.

The craft was of saucer shape, had the bigger Andromeda tachyon drives, and was armed with four triple gun turrets of large naval caliber (three inverted upside down and attached to the underside of the craft, and the fourth on top of the crew compartments).

A volunteer suicide crew of Germans and Japanese was chosen, because everybody knew that this journey was a one-way journey with no return. The large intensity of the electro-magnetogravitic fields and the inferior quality of the metal alloys used then for the structural elements of the drive, was causing the metal to fatigue and get very brittle only after a few months of work of the drive.

The flight to Mars departed from Germany one month before the war ended - in April 1945.

It was probably a large crew, numbering in the hundreds, because of the low level of automation and electronic controls inside the saucer. Most of the systems of the craft had to be operated like these on a U-boat of that time - manually. Because the structurally weakened tachyon drives were not working with full power and not all the time, *the trip to Mars took almost 8 months to accomplish.*

An initial short trust towards Mars was probably used to overcome the strong gravitational field close to Earth, after that the craft was "coasting" for 8 months in an elliptical orbit to Mars with its main drives turned off.

Later trips to Mars by the joint Soviet-American craft in 1952 and by the Vatican craft of the *Marconi project* from Argentina in 1956 reached Mars in only 2-3 days, because their drives were working during the whole flight: accelerating in the first half and decelerating in the second.

*Smaller Kohler converters* were probably used to power the systems and life support equipment on board. I do not have any information at the present time about any artificial gravity capability on board the craft, but that could have been easily done with the large antigravity drives of the ship.

After a heavy, almost crashing landing, the saucer slammed to a stop, damaging irreparably its drives, but saving the crew.

That happened in the middle of January 1946. The crash landing on Mars was not only due to the crippled tachyon drives of the craft - it was also due to the smaller gravitational field of Mars generating less power for the tachyon drives; and also due to the thinner atmosphere on Mars, that could not be used as effectively for air breaking as the Earth's atmosphere could.

The craft was shaped as a giant saucer - a form that is very efficient as an air brake, when it is entered into the atmosphere with its huge cross section perpendicular to the trajectory of descent.

First landing on the moon by the Germans was at Mare Imbrium on August 23, 1942 at 11:26 MEZ, using a Miethe rocket.

The first man on the moon was Kapitänleutnant **Werner Theisenberg** of the Kriegsmarine. Actually, the Navy did most of the work on the moon shots, not the Luftwaffe.

Landing took place without radio contact to the main control center at the Wilhelmshaven or the second control center located near Anzio, Italy. Ever since their first day of landing on the Moon, the Germans started borinq and tunneling under the surface and by the end of the war there was a small Nazi research base on the Moon.

One question, that I have not answered yet in the affirmative is how were the Germans able to regenerate the air inside the craft for 8 months for this big crew. Quite probably they were using advanced life support systems, developed initially for their larger Walter turbine and free energy submarines, that were cruising the oceans without resurfacing.

The radio message with the mixed news was received by the German underground space control centre in *Neu Schwabenland* and by their research base on the Moon.

The *Andromeda* was a craft with a diameter of 139 meters that was meant to transport troops, up to 5 saucers, and equipment. It was probably not built, although they could have done it easily...

Maybe some of the "flying cigars" that have been seen are later models...

#### Nikola Tesla

##### "Journey to Mars - Are We Already There?"

Jules Verne - and other early science fiction pioneers - wrote what was then considered to be far-fetched stories about the exploration of the moon and the planet Mars. They based their classic literary works not just on their own fertile imaginations, but on 'wild rumors' circulating that such voyages had already been made, accomplished by a group of scientists - all members of the same secret society.

They had tapped into an unknown power source, using it to facilitate the birth of flight, years before the Wright Brothers. Contacted by this secret fraternal order, Nikola Tesla furthered their cause, coming up with his own improved method of interplanetary travel, soon to be stolen and used by Adolf Hitler and the New World Order.

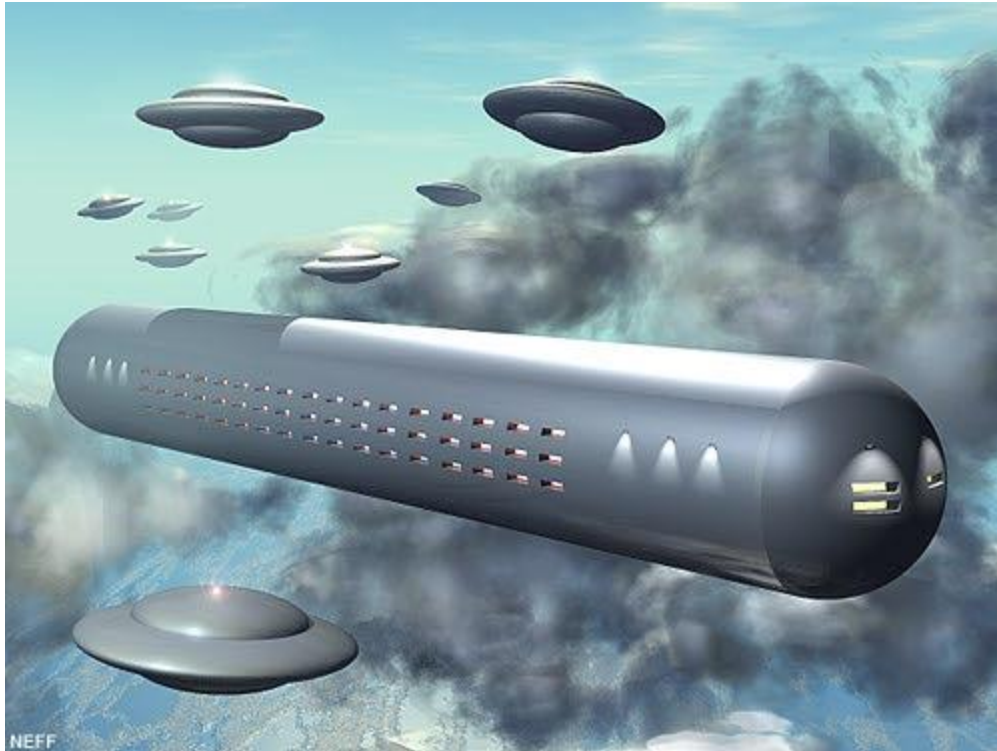

Forty seven years after World War II, in 1991, **Vladimir Terziski**, a Bulgarian immigree, came into possession of some German documentary film describing the Nazi V-7 special weapons programs. The secret V-7 projects were in fact a series of circular aircraft research designs developing radical new weapons platforms that could rise and descend vertically and fly at high speeds and very high altitudes using a new "implosion" motor design and other electro-gravitic energy conversion principles producing a self-sufficient electrostatically generated force for power.

Such engines were manufactured by **AEC**, (Allgemeine Elektrizitäts Gesellschaft), the great electrical giant of industrial Germany, for this program as early as 1944. These power devices generated their own electro-gravity field which neutralized the Earth's natural gravity, in effect making them weightless. Another new engine principle used helium for fuel.

There were at least three major developments within the V-7 program. There were the Haunebu models 1 through 3, at least; and Vril models 1 through 7 as well, and most likely beyond that. Then there was the cylindrical mother-ship carrier project designed to transport the Haunebu and Vril craft in flight. Research along these lines had been carried out since early in 1941.

The Haunebu models were larger discs ranging from 25 through 40 meters in diameter.

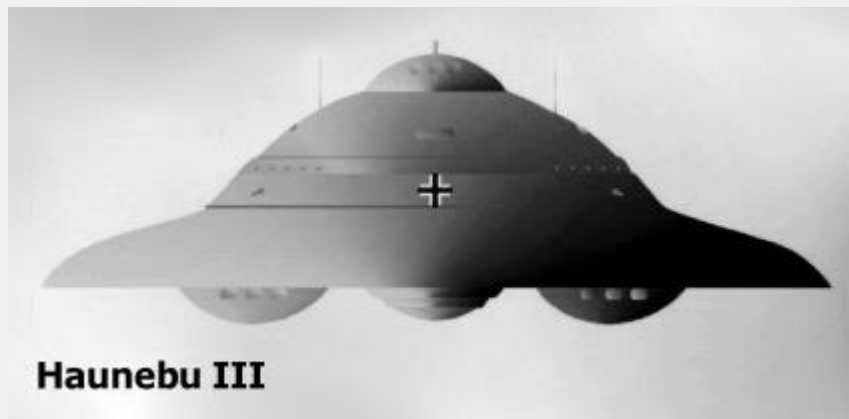

That is 75 to 120 feet. They were powered by multiple-ganged energy units working together, like the AEG System, and these units also generated their own electro-gravitic field which neutralized the natural gravity around them, thus making the craft and all it carried essentially weightless.

Experimental versions of this circular disc-shaped craft carried one to three 7.5 centimeter anti-tank cannon on their underside. Photographs of such craft have been collected by Mr. Terziski, some of which also appeared in the movie documentary.

One picture shows a 2 1/2 ton military truck parked beside a Haunebu 2, a lifting crane on the far side, and 2 men under the big disc working on something. Other pictures showed the Haunebu models in flight.

The Vril models were smaller deeper discs of nearly bell-shaped configuration in appearance with 3 hemispherical protuberances underneath, very similar to the bell-shaped flying objects photographed by George Adamski in 1952 and 1953, however the Vril 2, which is closest to that appearance, was actually being tested in 1943 and 1944 in Nazi Germany. The Vril 3 models and beyond were far more streamlined and looked more like the domed discs we are more familiar with. These little ships were 10.5 to 15 meters (30' to 45') in diameter and carried crews of 1 to 5 men.

The cylindrical carrier craft were over 100' in diameter and could carry one or more of the Haunebu models and 3 or more of the smaller Vril models, all internally, and could launch and recover them in flight.

When the High Command in Germany concluded that they could no longer win the war, and some of the key leaders began leaving the country to prepare for a resurgent 4th Reich, these important programs were apparently dismantled and carried to new bases in the Antarctic and to remote places in Brazil and elsewhere in South America.

Most of their key scientists went with them, which may be why we have heard so little of these programs up to now. The few scientists who remained behind were picked up by the U.S. and Russian governments and put to work on domestic programs, but our programs lacked the organization of the parent German programs that were evacuated.

Of course none of this report is proven by massive support evidence, nor should we expect it to be, given the secret nature of the work; and so this information can only stand as a speculative report - but it does raise a lot of unanswered questions.

---

Vril, Haunebu and the Andromeda-Gerät, were never mentioned by any source before **Vladimir Tersiski** hit the scene.

This is the same writer who claims to have proved that there is a breathable atmosphere, water, vegetation and even animals on the moon. Strangely enough, his descriptions of conditions on the moon sound an awful lot like those that were described by **George Adamski**, in *Inside the Space Ships*.

The fact that Terziski has obviously drawn heavily from Adamski's various writings seems to make no impression on those who want to believe in the existence of German flying saucers. They tend to characterize the similarities between the Haunebu and Adamski's 'Venusian scout ship', or the Andromeda-Gerät and Adamski's 'mother ship', as corroborative evidence.

In reality, it only proves that Terziski imitated Adamski.

## Nazis And The Grays

Researcher **Vladimir Terziski** believes, in spite of all the descriptions of 'aliens' given by abductees, that there are also craft constructed by 'the Illuminati' which are taking advantage of the 'alien' question by attempting to pass off their own black projects as 'alien technology'.

Although Terziski is uncertain as to the existence of [the so-called 'greys'](#), he does admit his belief in an ancient human-like society which possesses antigravity craft.

Terziski states that whether or not the 'greys' exist, the [New World Order](#) may be using the 'external' alien threat as a means to bring about world unity after the fall of Russia while,

"...at the same time hundreds of valid, but undesirable ET contacts with...more advanced races are debunked or ignored by the government."

If some researchers are correct, Bavarian Intelligence [the Illuminati's [Skull & Bones society](#), the Thule Societies "Nazi" Empire, and the **CIA-NSA** network that was 'german'ated from within the [Bavarian Illuminati](#) and Bavarian Thule societies] are actually working with [the 'Greys'](#) in secret.

Even if the 'New World Order' declares 'war' on these creatures, as opposed to a grassroots 'human resistance', one can be assured that this war be a farce as have other conflicts in the past.

It would very well be like the Korean war conflict wherein SOCIALISTS within the 'United Nations' waged a no-win 'police action' against southeast Asian COMMUNISTS. General George Douglas MacArthur for one accused the Socialist leadership of the U.N. of intentionally SABOTAGING his forces in Korea by leaking American positions to their Communist allies.

Now in recent years 'Patriot' organizations have been warning of a possible "RED DAWN" takeover of the U.S. by Socialist [UNITED NATIONS](#) troops who NOW HAVE AN INCREASING ARMY OF U.N. TROOPS "IN TRAINING" within the borders of the United States.

(If such a take-over attempt were to occur, we would suggest that the UNITED NATIONS complex in New York City increase it's security by at least a thousand fold to defend itself from the retaliation that would follow. Let's just say that there is an entire 'Army' of grassroots Patriots waiting-in-the-wings to defend America from such a threat if or when such an invasion is attempted).

The Bavarian "National" Socialists who ultimately control the U.N., such as [the Trilaterals](#), are reportedly tied-in with the reptilian gray empire, so it is doubtful that any resistance to the invaders will come through the *Trojanhorse United Nazis* (er, excuse us... United Nations!).

Such a 'war' may be the grand finale of a series of outward Machiavellian 'conflicts' which the Bavarian Empire has allegedly 'arranged' between nations over the centuries for the purpose of simply keeping the human race in the state of disorder, chaos, confusion and fear which is so necessary to ensure the final goal - an absolute electronic dictatorship in which every human being will be 'tagged' and branded like cattle with an electronic chip implant which will make them the absolute spiritual, mental and physical slaves of the 'New World Order'.

Multitudes may be deceived into receiving this "mark" of the Beast (or the "Serpent"?) and in doing so will have relinquished the greatest thing that they possess, their FREE AGENCY (and with it, their soul).

Terziski alleges that the Illuminati has been involved in top secret 'space R&D' [*Research & Development*] since the turn of the century, and that the Nazi's, the American Eastern Establishment, and the KGB has been involved as well. In other words, the lower classes of all these nations were themselves largely unfamiliar with such top secret research, although the 'Illuminists' working in the highest levels of internationalism were and are intricately involved.

Although it may sound rather incredible, Terziski alleges that he possesses confirming information such as the first video expose of Nazi UFOs. German/Japanese saucer *landings on the moon and Mars in 1944-46*, Marconi group's landing on Mars in 1956..., video footage of Nazi interplanetary dreadnoughts and... of *secret Soviet-American saucer landing on Mars* (below video).

LAND ON MARS 1962 (reconstruction or real document?)



Although many of the 'Greys' have been described as being of neo-sauroid configuration, other 'Greys' pose a different mystery as to their origin and seem to be more of a bio-synthetic or 'manufactured' configuration.

Vladimir Terziski suggests that some of these greys may be,

"...a product of the US government's biogenetic cyborg R&D program."

There may have been "secret society" ties behind the AXIS Alliance of World War II.

The [JESUITS ORDER](#) of ITALY, according to researcher **Edmond Paris**, *had strong connections with Adolf Hitler's S.S.*, and in fact may have been working with the THULE SOCIETY of GERMANY in establishing the S.S. as the premier German Intelligence Agency.

In turn, according to **Trevor Ravenscroft**, the Nazi occult lodges were in close contact with the occult *GREEN DRAGON society of JAPAN*.

ITALY, GERMANY and JAPAN were the three members of the "AXIS" powers who fought against the "ALLIED" alliance: the United States, Great Britain, and to a lesser degree, Russia.

Terziski is a Bulgarian born engineer and physicist, graduated Cum Laude from the Master of Science program of Tokai University in Tokyo in 1980. Served as a solar energy researcher, Bulgarian Academy of Sciences, before immigrating to the U.S. in 1984. International UFO researcher with command of English, Japanese, Russian, German, and Bulgarian. Creator/lecturer of UFOLOGY-101 course for University level attendance.

In a June 5, 1993 interview with talk-show host [Sam Russell](#) on *K-TALK radio* in Salt Lake City, Utah, Vladimir Terziski made the bold assertion that in one way or another, any independent scientists who discovers the secret of electromagnetic 'free-energy' antigravity-propulsion is soon *bought off, black-listed or killed by the Bavarian Illuminati*, which has for centuries been extremely determined to **maintain their monopoly** on such technology and keep it out of the hands of the masses.



The military arm of the Bavarian Empire, the Third Reich, was allowed to 'field test' much of this technology under supervision during World War II as the Bavarians were intent on establishing the "New World Order", by force if necessary.

Terziski also stated that a joint German-Japanese 'suicide' volunteer crew utilizing this 'confiscated' Illuminati 'free-energy' technology - a Hans-Kohler converter powered 'Dreadnaught', a giant craft approximately 230 feet in diameter - landed on Mars in mid January, 1946 after 8 months of heavy flight.

He did not say what became of this expedition, but he did state that the German Illuminati had established a base on the moon and planted their swastika flags there years before the Apollo program.

Terziski also stated that a 'secret' joint American-Russian space program - behind-the-scenes of the public program - had landed men on the moon BEFORE [the Apollo flights](#) as well, and had discovered the "ex-Nazi" base already in existence there.

One of the more startling claims made by Terziski in this interview was that the German experiments in [mind control](#), genetics, and hybridization (between humans and animals) - which were apparently aided by the discovery and perfection of the microscope in Germany, including a Tesla scaler-wave microscope which helped the Germans to unlock the human [genome](#) - were repeated in ten times their intensity in the underground Nazi South Polar colony or 'city'.

This base-city, rumor has it, is known by its inhabitants as the 'NEW BERLIN' and contains a population of over 2,000,000 people loyal to the Nazi philosophy. These include so-called pure-bred 'Aryan S.S.' who apparently utilize slave labor to expand their underground empire. The genetic experiments in this underground metropolis (as in the trilateral [Dulce-Dreamland-Luna facilities](#)) is reportedly continuing unabated.

Terziski claims that German occultists gained entrance to underground repositories below Tibet with the help of *Ahrimanic* and *Luciferian secret societies* in that country, where they gained access to ancient records from an early civilization which developed its own form of occult-technology.

According to Vladimir, the Nazi's had made contact with 'half a dozen' [alien races](#), including the malevolent reptilians, which may explain why they were so successful in their technological pursuits.

Could the U.S. government, fearful of the Nazi Empire/Gray Empire alliance, have chosen to negotiate with this powerful force rather than stand against it? ["if you can't beat'em, join'em"].

If so, it may have been a tragic, pathetic and cowardly decision not only for themselves but for their and our posterity. Apparently the Germans-Nazis-Illuminati had established a 'pact' with *the serpent races* long years before the American 'secret/conventional' hybrid government had done so.

The [South Polar base](#) according to [Vladimir Terziski](#) is also actively involved in space travel, and if the theories of **W. A. Harbinson** and others are correct, they may in fact constitute *the 'Aryan' blonds* who have been seen working with the grays and reptilians in UFO scenarios in their attempts to abduct, implant and program the minds of humans in an apparent long-term agenda to conquer the MINDS of the nations, and therefore the nations themselves.

Failing to do so during World War II in an overt manner, is Bavarian-Draconian alliance now attempting to bring about a covert takeover of the planet from their South Polar installation?

**Harbinson**, the author of the fact-fiction book '[GENESIS](#)', is convinced that they are...

## **We never went to the Moon**

It's all true. We never went to the Moon. **Neil Armstrong** and **Buzz Aldrin** *never set foot on Mare Tranquillitatus*. They filmed it all on a soundstage in Nevada's [Area 51](#).

**Stanley Kubrick** directed, slowing down the film speed to make it look like the astronauts were walking in low gravity. He used the same techniques he developed for his movie [2001: A Space Odyssey](#), which "coincidentally" came out in 1968, the same year that **NASA** claimed to send Apollo 8 around the moon.

But Kubrick was forced to do it, and so he left clues in the photographs. If you look at them closely you can see that some of the shadows do not match up and there are other inconsistencies. The flags wave when there is no air.

There are no blast craters under the lunar landers. Kubrick was a master filmmaker and he would not have been so sloppy with his art - he would have put the blast craters there and he would not have allowed the flags to wave. But perhaps he was trying to tell us something, provided we are smart enough to recognize it. Maybe that is why he died under mysterious circumstances in 1999.

President [John F. Kennedy](#) announced the lunar goal in 1961. But NASA scientists quickly realized that traveling to the moon is impossible. The Van Allen radiation belts will kill anybody who tries to reach the moon. NASA officials knew this early on and realized that they would have to fake it.

In fact, one of the reasons that the CIA, Lyndon Johnson, the Joint Chiefs of Staff, the military-industrial complex, and the Knights Templar *had John F. Kennedy killed* was because Kennedy was about to cancel the Apollo program. Too many people were going to make too much money from *faking the lunar program*, so Apollo had to continue.

Oliver Stone knew it. He even mentioned it in his movie *JFK*. And he has hardly worked since then. That is not a coincidence.

Lyndon Johnson knew that he had to get somebody competent to run the lunar hoax project, so he recruited the same person who told Franklin Roosevelt in November 1941 that the Japanese were planning to bomb Pearl Harbor. This man—we'll call him Mr. X—had previously helped Johnson fake the Gulf of Tonkin Incident and can be seen in photos of the grassy knoll in Dallas, carrying an umbrella. He worked as the executive secretary for [MAJESTIC-12](#).

For the lunar hoax project Mr. X recruited a number of people from the Philadelphia Experiment. The Brown and Root Company (now Halliburton) built the soundstages.

Of course it is ironic that the Americans had to fake the moon landings, because they already had access to the [flying saucer technology recovered at Roswell in 1947](#).

We now know from reputable sources that the Soviets were about to upstage the American Apollo 8 and Apollo 11 missions by sending cosmonauts to orbit the moon. But their rockets failed, which some people believe is even more proof that it is impossible to send people to the moon. Unfortunately, the Soviet Union lacked the filmmaking technology of the United States and they were unable to fake their own moon missions.

But they did find out about the American deception and blackmailed the United States into shipping them millions of tons of grain to buy their silence. Yuri Gagarin found out about this plan, which is why the KGB had him killed. Why else would the United States prevent its adversary from starving except to keep them silent about a major scandal?

Of course it is ironic that the Americans had to fake the moon landings, because they already had access to the flying saucer technology recovered at Roswell in 1947. The three alien pilots all died and were dissected at Wright Patterson Air Force Base, but the flying disc was relatively intact. Unfortunately, the Air Force was not able to successfully copy the disc's power source, which used a form of [Zero Point Energy](#) that the Nazis had tried to perfect.

After nearly two decades of trying, the project was finally shelved until the technology was later revived in the 1980s and successfully used to power the Aurora spy-plane during test flights in the Bermuda Triangle. Some of the flying disc technology was used in the Stealth Bomber.

By an amazing coincidence, the same hangar at Area 51 that for years housed the alien craft was used as the soundstage for the faked moon landings.

## Moon, life on

Among ancient philosophers to speculate about possible lunar inhabitants were **Anaxagoras**, **Xenophanes**, **Pythagoras** and his followers, **Plutarch**, and (in fiction) Lucian.

In the late middle ages, Nicholas of Cusa favored life on the Moon. However, speculation became more intense following the Copernican Revolution and Galileo's first lunar studies with the aid of a telescope (1608).

In his *Discovery of a New World in the Moone* (1638), **John Wilkins** summarized what were then widely held beliefs:

That those spots and brighter parts which by our sight might be distinguished in the Moon, do show the difference between the Sea and Land of that other World... The spots represent the Sea, and the brighter parts Land... That there are high mountains, deep valleys, and spacious plains in the body of the Moon...

That there is an atmosphere, or an orb of gross vaporous air, immediately encompassing the body of the Moon... That it is probable there may be inhabitants in this other World, but of what kind they are is uncertain...

Even at this early stage, however, there was sharp disagreement over how to interpret what the telescope showed. The two great lunar map-makers of the seventeenth century, Johannes Hevelius and Giovanni Riccioli, stood at opposite poles of the debate.

Whereas Hevelius populated his chart with seas and "selenites" (as he called his lunar inhabitants), Riccioli's Moon was dry and dead. The battle over lunar life continued throughout the eighteenth century, Johann Bode and William Herschel being notable among the pro-selenites.

By the turn of the nineteenth century, persuasive evidence was accumulating that the Moon lacked both sufficient air and water to support substantial life. Yet still the selenites had their champions, including the extremists Schröter and Gruithuisen, and the moderates Gauss, von Littrow, and Olbers. Improved lunar maps in the 1830s, by Wilhelm Lohrmann and by Beer and Mädler, helped persuade most astronomers that the Moon was unlikely to be inhabited.

Even so, this did not prevent **Richard Locke** from creating a worldwide sensation in 1835 with his great "Moon Hoax".

By the end of the 19th century, lunar life had passed more or less from the realm of science into that of science fiction. Jules Verne posed the question in *Around the Moon* (1870) and teased with his reply, George Griffith's adventurers in *Stories of Other Worlds* (1900) find the ruins of a civilization and its bestial offspring, while, as late as 1901, in *The First Men in the Moon*, **H. G. Wells** was able to exploit lingering public credulity with his tale of a hollow Moon, richly varied selenites, and massively cerebral Grand Lunar.

And yet the romance did not quite end with these gaslight fantasies.

In the 1920s, **William H. Pickering**, a staunch advocate of Martian vegetation, argued that certain dark areas on the Moon which changed shape were due to spreading plants,<sup>1</sup> while almost half a century later the remote possibility of microbial lunar life was still on the minds of NASA scientists when they quarantined the first Apollo astronauts and their rock samples – a well-advised (but, in the event, ill-performed) precaution in view of the bacterial survivors found on the returned camera of Surveyor 3. Arthur C. Clarke suggested remains of another kind on the Moon in his short story "The Sentinel"<sup>2</sup> which blossomed into *2001: A Space Odyssey*.

In reality, it seems, the Moon has always been dead. However, the prospects for future intelligent (human) life on our nearest neighbor have been greatly improved by the discovery of billions of tons of ice in some deep lunar craters (see [Lunar Prospector](#)).

See also Moon trees.

## References

1. Pickering, W. H. "Eratosthenes," 1 to 6, *Popular Astronomy*, nos. 269, 287, 312, and 317 (1919-25).
2. Clarke, Arthur C. "The Sentinel." In *Expedition to Earth*. New York: Harcourt, Brace and World (1970).

## **Moon, water on**

The belief that the dark lunar areas, or *maria*, might be seas was held by Plutarch and others in the ancient world.

In his *Siderius Nunctius*, **Galileo** wrote that,

" ... [the] brighter part most fitly represents its land surface, but its darker part the watery surface ..."

Later, he came to doubt this interpretation, but others, including Wilkins, Hevelius, Schröter, and William Herschel kept the idea of a maritime Moon alive for the next two centuries.

The demise of lunar water accompanied that of a lunar atmosphere, since liquid water cannot exist where the atmospheric pressure is extremely low or zero. Ice, however, does exist in regions at the Moon's poles.

This surprising fact, first suggested by data from the Clementine probe, in 1994, was confirmed, in March 1998, by observations made by Lunar Prospector. After further analysis,<sup>1</sup> the initial conservative estimate of 300 million tons was increased by a factor of 10, to 3 billion tons at each pole, enough to fill a lake about 100 meters deep and 6 km across. The possibility also exists that there may be more.

The instrument aboard Lunar Prospector used for this determination can detect the presence of water (or, more precisely, hydrogen) to a depth of 0.5 meter.

Since lunar soil has been turned over by meteorite impacts during the past couple of billion years to a depth of about 2 meters, water could theoretically be present to this depth. However, if (as suspected) this water exists as crystals mixed in with the lunar regolith, larger amounts of pure water ice deposits could potentially exist at much greater depths.

The lunar ice is thought to have come from comets which collided with the Moon in the remote past. Although most of the water deposited on the lunar surface in this way would have been vaporized long ago by the daytime heat of the Sun, in small, permanently shaded regions at the poles it has evidently survived. Its presence is further evidence that water, frozen or otherwise, is a common commodity on many worlds, and this, in turn, raises the prospects for extraterrestrial life.

The availability of water on the Moon is also a major boost to any plans for establishing a self-sustaining lunar colony.

## References

Feldman, W. C., Maurice, S., Binder, A. B., Barraclough, B. L., Elphic, R. C., and Lawrence, D. J. "Fluxes of Fast and Epithermal Neutrons from Lunar Prospector: Evidence for Water Ice at the Lunar Poles," *Science*, 281, 1496 (1998).

## Alien Presence on the Moon?

Is there an "Alien Base" on the Moon?

More and more people are coming forward with stories of an Alien presence on the Moon. Rumors say that there is an *Alien Moon Base* on the far side of the moon, the side we never see from Earth.

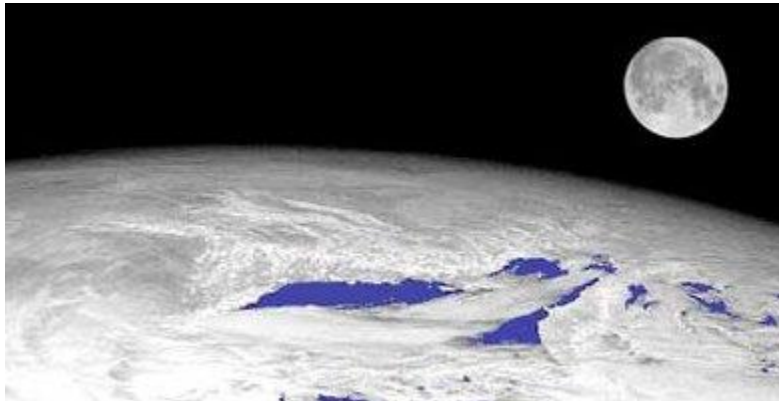

Did you ever wonder why the Moon landings stopped and why we have not tried to build a Moon Base?

It does seem like a better and easier idea than a floating space station with no access to any raw materials or supplies? According to NASA Astronaut **Neil Armstrong** the *Aliens have a base on the Moon and told us in no uncertain terms to get off and stay off the Moon!*

Sound far fetched?

**Milton Cooper** a Naval Intelligence Officer tell us that not only does the *Alien Moon Base* exist but the U.S. Naval Intelligence Community refers to the Alien Moon Base as "Luna", that there is a huge mining operation going on there, and that is where the Aliens keep their huge mother ships while the trips to Earth are made in smaller "flying saucers".

"LUNA: The Alien base on the far side of the Moon. It was seen and filmed by the [Apollo Astronauts](#). A base, a mining operation using very large machines, and the very large alien craft described in sighting reports as mother ships exist there."

**Milton Cooper**

in **Apollo 11 Encounter UFOs on the Moon?** from the Book "**Above Top Secret**" by Timothy Good

---

## Did Apollo 11 Encounter UFOs on the Moon?

by Timothy Good

from the Book "Above Top Secret"

According to hitherto unconfirmed reports, both Neil Armstrong and Edwin "Buzz" Aldrin saw UFOs shortly after that historic landing on the Moon in Apollo 11 on 21 July 1969. I remember [hearing one of the astronauts](#) refer to a "light" in or on a carter during the television transmission, followed by a request from mission control for further information. Nothing more was heard.

According to a former NASA employee **Otto Binder**, unnamed radio hams with their own VHF receiving facilities that bypassed NASA's broadcasting outlets picked up the following exchange:

NASA: What's there? Mission Control calling Apollo 11...

Apollo: These "Babies" are huge, Sir! Enormous! OH MY GOD! You wouldn't believe it! I'm telling you there are other spacecraft out there, Lined up on the far side of the crater edge! They're on the Moon watching us!

In 1979 **Maurice Chatelain**, former chief of *NASA Communications Systems* confirmed that Armstrong had indeed reported seeing two UFOs on the rim of a crater.

"The encounter was common knowledge in NASA," he revealed, "but nobody has talked about it until now."

Soviet scientists were allegedly the first to confirm the incident.

"According to our information, the encounter was reported immediately after the landing of the module," said Dr. Vladimir Azhazha, a physicist and Professor of Mathematics at Moscow University. "Neil Armstrong relayed the message to Mission Control that two large, mysterious objects were watching them after having landed near the moon module. But his message was never heard by the public - because NASA censored it."

According to another Soviet scientist, Dr. **Aleksandr Kazantsev**, Buss Aldrin took color movie film of the UFOs from inside the module, and continued filming them after he and Armstrong went outside. Dr. [Azhazha](#) claims that the UFOs departed minutes after the astronauts came out on to the lunar surface.

Maurice Chatelain also confirmed that Apollo 11's radio transmissions were interrupted on several occasions in order to hide the news from the public.

Before dismissing Chatelain's sensational claims, it is worth noting his impressive background in the aerospace industry and space program. His first job after moving from France was as an electronics engineer with Convair, specializing in telecommunications, telemetry and radar. In 1959 he was in charge of an electromagnetic research group, developing new radar and telecommunications systems for Ryan. One of his eleven patents was an automatic flights to the Moon.

Later, at *North American Aviation*, Chatelain was offered the job of designing and building the Apollo communications and data-processing systems.

Chatelain claims that,

"all Apollo and Gemini flights were followed, both at a distance and sometimes also quite closely, by space vehicles of extraterrestrial origin - flying saucers, or UFOs, if you want to call them by that name. Every time it occurred, the astronauts informed Mission Control, who then ordered absolute silence."

He goes on to say:

"I think that Walter Schirra aboard Mercury 8 was the first of the astronauts to use the code name 'Santa Claus' to indicate the presence of flying saucers next to space capsules. However, his announcements were barely noticed by the general public.

It was a little different when James Lovell on board the Apollo 8 command module came out from behind the moon and said for everybody to hear: 'PLEASE BE INFORMED THAT THERE IS A SANTA CLAUS.' Even though this happened on Christmas Day 1968, many people sensed a hidden meaning in those words."

Rumors persist. **NASA** may well be a civilian agency, but many of its programs are funded by the defense budget and most of the astronauts are subject to military security regulations.

Apart from the fact that the *National Security Agency (NSA)* screens all films and probably radio communications as well. We have the statements by [Otto Binder](#), Dr. [Garry Henderson](#) and [Maurice Chatelain](#) that the astronauts were under strict orders not to discuss their sightings.

And Gordon Cooper has testified to a United Nations committee that one of the astronauts actually witnessed a UFO on the ground. If there is no secrecy, why has this sighting not been made public?

A certain professor, who wished to remain anonymous, was engaged in a discussion with Neil Armstrong during a NASA symposium.

**Professor:** What REALLY happened out there with Apollo 11?

**Armstrong:** It was incredible, of course we had always known there was a possibility, the fact is, we were warned off! (by the Aliens). There was never any question then of a space station or a moon city.

**Professor:** How do you mean "warned off"?

**Armstrong:** I can't go into details, except to say that their ships were far superior to ours both in size and technology - Boy, were they big!... and menacing! No, there is no question of a space station.

**Professor:** But NASA had other missions after Apollo 11?

**Armstrong:** Naturally. NASA was committed at that time, and couldn't risk panic on Earth. But it really was a quick scoop and back again.

Armstrong confirmed that the story was true but refused to go into further detail, beyond admitting that the CIA was behind the cover-up. (thanks to BBS)

**More information: Sensation - Cities Found on the Moon!**

Reasonable activity of an alien civilization showed up unexpectedly close to us. We were not ready for it psychologically



We still can come across publications trying to find an answer to the question: Are we alone in the universe?

At the same time, presence of reasonable creatures has been detected just close to our home, in the Moon. However, the discovery was immediately classified as secret, as it was so much incredible that even could shake the already existing social principles, reports Russia's newspaper *Vecherny Volgograd*.

Here is an extract from the official press-release:

"NASA scientists and engineers participating in exploration of Mars and Moon reported results of their discoveries at a briefing at the Washington national press club on March 21, 1996. It was announced for the first time that *man-caused structures and objects had been discovered on the Moon.*"

The scientists spoke rather cautiously and evasively about the functioning objects, with the exception of UFO. They always mentioned the man-caused objects as possible, and pointed out the information was still under study, and official results would be published later.

It was mentioned at the briefing as well that the Soviet Union used to own some photo materials proving presence of reasonable activity on the Moon. And although it wasn't identified what kind of reasonable activity it was, thousands of photo-and video materials photographed from the Apollos and the Clementine space station demonstrated many parts on the lunar surface where the activity and its traces were perfectly evident.

The video films and photos made by US astronauts during the Apollo program were demonstrated at the briefing. And people were extremely surprised why the materials hadn't been presented to the public earlier.

And **NASA** specialists answered:

"It was difficult to forecast the reaction of people to the information that some creatures had been or still were on the Moon. Besides, there were some other reasons to it, which were beyond NASA.

Specialist for lunar artifacts [Richard Hoagland](#) says that NASA is still trying to veil photo materials before they are published in public catalogues and files, they do retouching or partially refocus them while copying.

Some investigators, Hoagland is among them, suppose that an extraterrestrial race had used the Moon as a terminal station during their activity on the Earth.

The suggestions are confirmed by the *legends and myths invented* by different nations of our planet.

[Ruins of lunar cities](#) stretched along many kilometers, huge transparent domes on massive basements, numerous tunnels and other constructions make scientists reconsider their opinions concerning the lunar problems. How the Moon appeared and principles of its revolving around the Earth still pose a great problem for scientists.

Some partially destroyed objects on the lunar surface can't be placed among natural geological formations, as they are of

complex organization and geometrical structure. In the upper part of *Rima Hadley*, not far from the place where the Apollo-15 had landed, a construction surrounded with a tall D-shaped wall was discovered.

As of now, different artifacts have been discovered in 44 regions. The *NASA Goddard Space Flight Center*, the *Houston Planetary Institute* and specialists from the bank of space information are investigating the regions.

Mysterious terrace-shaped excavations of the rock have been discovered near the Tiho crater. The concentric hexahedral excavations and the tunnel entry at the terrace side cant be results of natural geological processes; instead, they look very much like open cast mines. A transparent dome raised above the crater edge was discovered near the crater Copernicus.

The dome is unusual as it is glowing white and blue from inside. A rather unusual object, which is unusual indeed even for the Moon, was discovered in the upper part of the Factory area. A disk of about 50 meters in diameter stands on a square basement surrounded with rhombi walls. In the picture, close to the rhombi, we can also see a dark round embrasure in the ground, which resembles an entry in an underground caponier.

There is a *regular rectangular area* between Factory and the crater Copernicus which is 300 meters wide 400 meters long.

Apollo-10 astronauts made a unique picture ([AS10-32-4822](#)) of a one-mile long object called *Castle*, which is hanging at the height of 14 kilometers and casts a distinct shadow on the lunar surface. The object seems to be consisting of several cylindrical units and a large conjunctive unit. Internal porous structure of the Castle is clearly seen in one of the pictures, which makes an impression that some parts of the object are transparent.

As it turned out at the briefing where many NASA scientists were present, when Richard Hoagland had requested originals of the Castle pictures for the second time, no pictures were found there at all. They *disappeared* even from the list of pictures made by the Apollo-10 crew. Only intermediate pictures of the object were found in the archives, which unfortunately donut depict the internal structure of the object.

When Apollo-12 crew landed on the lunar surface, they saw that the landing was observed by a half-transparent pyramidal object. It was hanging just several meters above the lunar surface and shimmered with all rainbow colors against the black sky.

In 1969, when the film about astronauts traveling to the Sea of Storms was demonstrated (the astronauts saw the strange objects once again, which were later called "striped glasses"), NASA finally understood what consequences such kind of control could bring.

Astronaut **Mitchell** answered the question about his feelings after a successful return the following:

"My neck still aches as I had to constantly turn my head around because we felt we were not alone there. We had no choice but pray."

Johnston, who worked at the Houston Space Center and studied photos and video materials done during the Apollo program, discussed the artifacts with Richard Hoagland and said, the NASA leadership was awfully annoyed with the great number of anomalous, to put it mildly, objects on the Moon. It was even said that piloted flights to the Moon could be banned in the programs network.

Investigators are especially interested in ancient structures resembling partially destroyed cities. The orbital shooting reveals an astonishingly regular geometry of square and rectangular constructions. They resemble our terrestrial cities seen from the height of 5-8 kilometers. A mission control specialist commented on the pictures:

“Our guys observed ruins of the Lunar cities, transparent pyramids, domes and God knows what else, which are currently hidden deep inside the NASA safes, and felt like Robinson Crusoe when he suddenly came across prints of human bare feet on the sand of the desert island.”

What do geologists and scientists say after studying the pictures of lunar cities and other anomalous objects? They say, such objects can't be natural formations.

“We should admit they are artificial, especially the domes and pyramids. “

Reasonable activity of an alien civilization showed up unexpectedly close to us. We were not ready for it psychologically, and some people hardly believe they are true even now.

---

## **UFOlogy Journal**

1996 Chinese UFOlogy Association  
China (Taiwan)

# 飛碟探索

UFOlogy Journal 中華飛碟學研究會出版

台灣幽浮界廿年大事記 飛碟在中國可以破謎 收藏本 7  
多重時空詮釋佛經諸天 幽浮追蹤 龍在中國

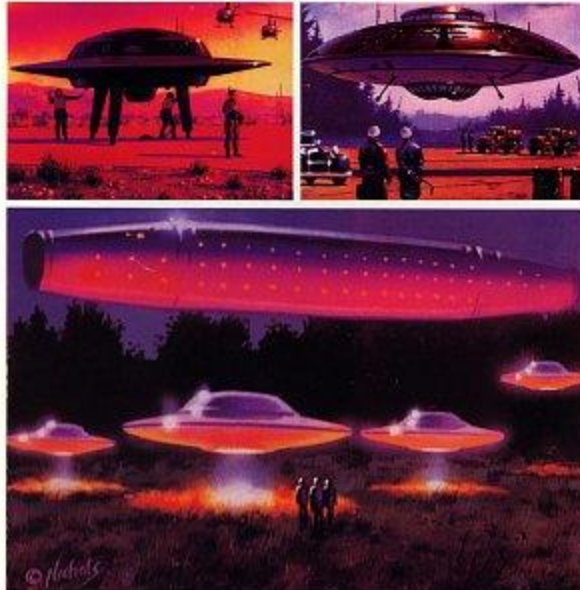

In a now infamous 1961 speech, US President John F. Kennedy pledged that America's space program would "place a man on the moon before the decade's close."

At the heart of cold war battles for geopolitical supremacy, the *National Aeronautics and Space Administration's (NASA)* Mercury, Gemini and Apollo programs also became the vehicle for inculcating domestic populations with American values and belief systems.

NASA's growing power, its protection by the Kennedy administration, and the rise of the Right Stuff astronaut as celebrity hid the steady growth of the Military-Industrial Complex that Eisenhower had warned about.

These anxieties - of monolithic social institutions controlling information, and the decline of US global empires - are the core of conspiracy theories claiming the historic Apollo moon landings were elaborately faked.

The world was *hoaxed*.

Conspiracy theorists like **Bill Kaysing** and **Ralph Rene** claim that:

- The Nazis built a small moon base.
- Strange geological structures are evidence of alien life.

- NASA photos were 'doctored' and transmissions were censored.
- NASA "stage managed" astronaut interviews and press conferences.
- NASA "conditioned" astronauts by Nazi-derived mind control techniques.
- The Van Allen Belt's high radiation levels prevented the astronauts from leaving Earth.
- Apollo 1 astronauts Grissom, Chaffee and White were going to reveal NASA's conspiracy to the world, so they were murdered in a 1967 launch-pad fire.

Perhaps the most believable part of Kaysing and Rene's scenario is their analysis of the space industry as a political economy.

The authors contend that, in a climate of lucrative multimillion dollar industrial contracts and public euphoria, the Military-Industrial Complex fueled the conspiratorial imperative for creating *Lunargate*.

These hoax theories can teach us much about the Paranoid Style of post-Watergate American politics. The fascination with decoding NASA photographs for clues and analyzing suggestive scenes in films like *Diamonds Are Forever* (1971) and *Capricorn One* (1978) echo Marshall McLuhan's media models and postmodern theorists' fascination with ambiguous texts and the limits of knowledge.

When [Bill Kaysing](#) claims that the Apollo 13 debacle was a "simulation within a simulation," or anonymous theorists suggest that director Stanley Kubrick filmed the historic Apollo 11 moon landing (July 20, 1969) on a Nevada soundstage, they offer scenarios that closely resemble postmodernist Jean Baudrillard's concept of American culture as hyper-real:

People's imagination demands the real thing, but in order to get it, they have to create fakes.

NASA's verifiable history has had some questionable aspects:

- The use of Nazi V2 rocket scientists saved by [Operation Paperclip](#).
- Several key Apollo astronauts were 33° [Masons](#).
- The questionable management decisions by Morton Thiokol Inc that indirectly caused the [Challenger space shuttle disaster](#).

The real concern of these conspiracy theorists, maybe, is the long-term fate of NASA's space program. Resource allocation pressures have made it difficult over the past thirty years for a large-scale population the Overview Effect (comprehending Earth as a single integrated system that is post nation-state/tribal band) consciousness change that astronauts experienced.

US Congress passed a bill in 1999, celebrating the 30th anniversary of the Apollo moon landing... and then cut NASA's annual budget by over \$1 billion.

Maybe the real conspiracy is one of institutional infighting and bureaucratic stupidity.

---

## The alternative conquest of the Moon

by Philip Coppens



This article originally appeared in  
Frontier Magazine 1.3 (1995) and was slightly adapted  
from [PhilipCoppens](#) Website

Man officially set foot on the Moon for the first time in July 1969. Or if you believe we never went to the moon: it is promoted that we officially set foot on the Moon for the first time in July 1969. But there have been stories that extraterrestrial beings had already been to the Moon, or had a basis there... and even that we ourselves went to the Moon long before Neil Armstrong.  
Philip Coppens



Our earth's satellite, which once every moon turns around our Earth, has driven Mankind for centuries to lunacy.

Seeing "the man in the moon" is but one in a long series of stories that echoes our fascination with the white disc that lights up our nightly skies.

The introduction of modern equipment that allowed Mankind to look towards the Moon with telescopes, meant that one Englishman, Sir John Herschel, directed his scope to the moon at the start of the 19<sup>th</sup> century. Through his lens, he claimed to see strange objects on the surface of the moon. During an eclipse, he stated that he had observed lights, lights that seemed to move. As early as 1788, the astronomer Schroeter had observed small "swollen parts" on the Moon. He argued that these were the result of industrial activity of the "*Selenites*", the inhabitants of the moon.

Other astronomers from the era reported light structures, which looked remarkable similar to those observed on cities on Earth. In 1869, the *Royal Astronomical Society* of Great Britain started a three year long investigation, after numerous sightings of anomalous lights in the Mare Crisium part of the Moon.

Though one century before Apollo 11's mission to the Moon, it was nevertheless not the first time that Mare Crisium had been the focus of attention. It would not be the last time either. On July 29, 1953, John J. O'Neill, editor in chief of the scientific columns of the *New York Herald Tribune*, dedicated his free time by observing our satellite through his

telescope. He observed what he felt was a bridge that spanned the crater in the Mare Crisium. He estimated that the bridge measured approx. 15 miles long.

O'Neill spoke about his discovery in a rather careful tone, suggesting that this was a "natural bridge" which "somehow" had formed itself, this in the course of just one night. He reported his find to the Association of Lunar and Planetary Observers, but his report was mocked and attacked.

One month later, the legendary British astronomer Dr. H.P. Wilkins confirmed the findings of O'Neill. Patrick Moore, another of the leading figures of English astronomy, confirmed the observation.



In the 1970s, NASA wanted to investigate what they had labeled "*Lunar Transient Phenomena*" (LTP): suddenly visible objects on the surface of the moon ([above image](#)).

The project was not a success as the project members did not adhere to the project scope. Nevertheless, NASA offered an explanation to these phenomena; it involved gases that escaped from lava, which occurred at sunrise, resulting in ultraviolet light, as well as other particles that create the luminous effect. And if this was not the correct or only explanation, then it could also be due to volcanic activity.

LTP or ULOs, *Unidentified Light Objects*, were nevertheless not a new phenomenon – astronomers knew about it. But what was it? Was NASA correct in its explanations that it involved purely natural phenomena? Or was it indeed evidence of the presence of an intelligence?

The British UFO researcher **Timothy Good** reports the story of "a certain professor", whose name is not given, working for the British military intelligence agency, speaking to Neil Armstrong.

The conversation occurred during a NASA conference, when the professor prodded Armstrong for details as to what exactly happened during the Apollo 11 mission.

"It was incredible", reported Armstrong.

"Naturally, we always knew that the possibility existed... but it is so; we were warned. Ever since, the possibility of a space station or building a city on the Moon, has disappeared."

The professor asked what Armstrong meant when he stated they had been "*warned*".

"I cannot give details, except to say that their ships are superior to ours, both in science and technology... boy, they were big... and menacing... no, there is just no way we can build a space station."

The professor prodded that NASA had nevertheless sent further missions to the Moon, following Armstrong's visit.

"Of course, NASA could not do otherwise, they could not risk that a panic would break out on Earth."

Later, Armstrong would deny that this conversation ever occurred.

Almost twenty years before Armstrong's trip, America had been confronted with **George Adamski**, the archetypal UFO contactéé, who claimed to have met alien beings... and have even been given rides in their spaceship.

Adamski claimed that amongst the excursion on offer were many trips to the Moon. He stated that he seen plants and even animals roaming the surface of the Moon.

In August 1954, Adamski had observed large hangars, harboring gigantic spacecrafts.

**Howard Menger**, another contactéé, stated that he had gone to the Moon in August 1956, where he had seen many buildings. It seems that July-August, even before Armstrong's visit to the Moon, was already the Moon's top season for earthly tourism.

During a second visit to the Moon, Menger was allowed to take photographs, which he published in his book [From Outer Space to You](#). Menger also reported that he had seen visitors from Russia, Japan and Germany, all visiting the Moon.

Japan and Germany were the old enemies of a war that had barely ended a decade before Menger's lunar tourism. The possibility of a basis on the Moon at the time was not just the bailiwick of extraterrestrial beings; for some, it was the legacy of the Nazi regime, who had always been fascinated, if not obsessed with the conquest of space. There are stories that the Nazis had a lunar basis since 1942.

To reach the Moon, the Nazis had built an "exo-atmospheric rocket", measuring 15 by 50 meters, with an engine powerful enough to allow this form on interplanetary exploration possible. The basis itself was said to measure 60 by 45 meters, splashed out over ten floors. NASA was said to know about the basis, but had elected to keep it a secret. Apparently, its inhabitants did not require space suits to walk on the surface of the Moon: normal clothing was sufficient.

According to the story, the Germans had preoccupied themselves with the creation of tunnels in the surface of the Moon. They would have used a free energy device to travel between the Earth and the Moon, used to transport personnel, material and even robots. The launches occurred from the South polar colony on [Neu Schwabenland](#).

To round off the tale, it was said that when the Americans and Soviets made their first joint voyage to the Moon in their own flying saucers, the visitors spent their first night on the Moon in the Nazi sublunar base.



Photograph taken by Howard Menger of one of his "spaceship", in which he claimed to visit the Moon



These tales are far away from the much more mundane conquest of the Moon. Nevertheless, some mystery surrounding the Moon has always intrigued scientists. The front page of the November 2 1966 edition of *The Washington Post* read:

“Six Mysterious Statuesque Shadows Photographed on the Moon by Orbiter”.

The Lunar Orbiter 2 had photographed a lunar area of approximately 30 by 50 kilometers. The photo apparently showed six or seven towers, appearing in a specific geometric pattern, rising from the *Mare Tranquillis*. Their pointed shadow indicated that they were either conical or pyramid-shaped. (image left)

One of the towers measured an impressive 213 meters. NASA countered that the photographs did not show anything of any interest... whatsoever. Perhaps in an effort to merely embarrass the Americans, the Russian magazine *Argosy* offered the opinion of the Russian space scientist Alexander Abromov.

He stated that the Russian Luna 9 had, on landing on the Moon on February 4 1966, taken some bizarre photographs: structures that stood in the landscape in a certain pattern.

“The location of these lunar objects is comparable to the location of the pyramids at Gizeh. The tops of the towers show the same pattern as the tops of the pyramids.”

One decade afterwards, in 1976, George Leonard published [Somebody Else is on our Moon](#).

Leonard stated he done extensive research in NASA's archives and had found several photographs, including some of the first, unmanned mission to the Moon. Leonard's effort was followed by Fred Steckling, who wrote [We Discovered alien Bases on the Moon](#) in 1981.

It was an analysis of 125 photographs, on which [Steckling](#) pointed out “evidence” of buildings and other constructions on the surface of the Moon. Major parts of this publication, privately published, were later reused by David Hatcher Childress in his [Extraterrestrial Archaeology](#).

Indeed, many of the photographs that were used did seem to indicate anomalies that apparently did not belong on the surface of our Moon. In the late 1980s, Leonard's research was handed over to **James Sylvan**, who reanalyzed Leonard's material.

Sylvan then handed his material over to [Richard Hoagland](#), who had been writing about the strange objects that were visible in photographs of the planet Mars. Hoagland and co. used “fractal imaging” to analyze the photographs and identified the various anomalous structures as “the shard”, “the tower” and “the cube”.

Specific attention was given to the Ukert crater, a crater which is the closest part of the Moon to Earth. Hoagland's contact with geologist Dr. Bruce Cornet resulted in the observation that the crater apparently contained a triangle.

Cornet confirmed that this could not be a natural event, but was proof of an artificial origin. Cornet also stated that the structure labeled “the Shard”, visible on a photograph of the Lunar Orbiter III in 1967, was the best available evidence that there were enigmatic – artificial – structures on the surface of our Moon.

The Shard was apparently more than 1.5 kilometers high. He stated that if it was natural, it would be the miracle of the universe, defying all known patterns of erosion. But the Shard was apparently topped by “the Tower”, which rose no less than five miles above the surface of the Earth.



“The Castle”, one of the structures identified in lunar photographs, identified by Richard Hoagland

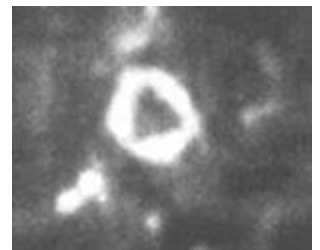



The Shard, believed by some to be the best evidence of artificial structures on the Moon

Such massive construction projects were possible because of the lower gravitational pull that existed on the surface of the Moon. Hoagland and team stated that the Tower had been seen by Armstrong and team... and had even been filmed by them.

All these structures were apparently made from glass. Though fragile on Earth, in the void environment of the Moon, glass would achieve the same rigidity as steel is known to have on Earth.

What are we to make of these stories?

The photographs of most if not all of these claims are grainy at best, and impossible to view at worst. In the case of the claims of Sir John Herschel, it seems that the entire event of his "discoveries" on the Moon was nothing more than a hoax, run by a newspaper.

The *New York Sun* ran the article about Herschel in late August 1835. The article immediately invited skepticism.

On August 29, 1835 the *New York Commercial Advertiser* argued it was a hoax. Authorship of the hoax was attributed to Richard Adams Locke, a Cambridge-educated reporter working for the Sun.

Locke never admitted to being the author of the hoax, and the Sun equally never conceded it was a hoax.

On September 16, 1835, *the Sun* did publish a column in which it discussed the possibility that the story was a hoax, but it never confessed to anything.

Quite the contrary.

"Certain correspondents have been urging us to come out and confess the whole to be a hoax; but this we can by no means do, until we have the testimony of the English or Scotch papers to corroborate such a declaration."

And as with all of these stories, it will only take a culture of openness and trust – and only then return visits to the Moon – before we can compare the two versions of history: the *official version*, and the *alternative version*.

## Return to The Moon

### "Moon Hoax"

There are two "*Moon hoaxes*."

1. **The first**, sometimes referred to as the "Great Moon Hoax," was perpetrated in 1835 by Richard Adams Locke, a writer hired by the newly established 'New York Sun'.

Having already dabbled in science fiction, it occurred to him to expand his activity in this direction without actually telling anyone. For his subject, he chose the astronomical expedition of John Herschel to the Cape of Good Hope. Beginning with the Aug. 25, 1835 issue of the Sun, Locke describes in detail all kinds of fantastic discoveries having been made by Herschel with a telescope of such power, he said, that it could see objects on the lunar surface as small as 18 inches across.

In the second installment, the exotic variety of life supposedly found by Herschel is revealed, including a *goat-like animal* with a single horn and "an amphibious creature of spherical form, which rolled with great velocity across the pebbly beach." On Aug. 29, Locke broke the news that lunar intelligence had been found in the guise of "Vespertilio-homo", or bat-men.

Finally, on Aug. 31, he spoke of the discovery of yet higher beings and of "the universal state of amity among all classes of lunar creatures...."

Huge interest was created by the articles and, briefly, the Sun became the best-selling newspaper in the world. 'The New York Times' believed the reports both "probable and possible", the 'New Yorker' thought they heralded "a new era in astronomy", Yale was said to be "alive with staunch supporters", while, according to another report, an American clergyman considered starting a collection for Bibles for the lunar inhabitants.

The fact that the "Moon Hoax" was almost certainly nothing of the kind has been argued compellingly by Michael Crowe who cites an account of the affair written by **William Griggs** in 1852.

According to Griggs:

"We have the assurance of the author, in a letter published some years since, in the New World, that it was written expressly to satirize the unwarranted and extravagant anticipations upon this subject...."

Yet, the irony is, the hoax failed because the public had been primed for so long by the strident advocates of pluralism to expect intelligent life on other worlds.

2. **The second** "Moon hoax" is the more modern claim that the Apollo missions never landed on the Moon. Sadly, this is born of the same kind of scientific ignorance and naïveté that allowed Locke's tale to take root. It may seem incredible that, in the 21st century, a considerable number of people in developed nations, notably the USA, could entertain the notion that men have not visited the Moon.

This silly scenario was given unnecessary (but, doubtless, commercially successful) support, in February 2001, by a prime-time Fox TV special, "Conspiracy Theory: Did We Land on the Moon?" Amateur theorists were allowed to parade such easily-countered objections as "Why are there no stars in the pictures sent back from the Moon?" (Answer: If the cameras had been adjusted to pick up the stars, the surface would have appeared dazzlingly bright).

Unfortunately, **NASA** may have compounded the problem in 2002 by budgeting \$15,000 to hire a former rocket scientist, James Oberg, to produce a small book refuting the disbelievers' claims (primarily for the benefit of teachers and students) but then backing away from the project for fear that it would lend credibility to, as NASA Administrator Sean O'Keefe put it, "something that is, on its face, asinine."

However, there remains a need, especially in the United States, to counter scientific illiteracy and the growing belief in pseudoscience of all descriptions, including creationism.

While attending the Cape Canaveral premiere of the IMAX version of *Apollo 13 in November 2002*, *Tom Hanks* said the film industry had a responsibility to promote historical literacy.

He took a jab at the 1978 movie *Capricorn One*, which had NASA's first manned mission to Mars being faked on a sound stage.

He said:

"We live in a society where there is no law in making money in the promulgation of ignorance or, in some cases, stupidity."

Of course, there will always be those who remain unconvinced. But it is important for the future, and for the education of young people who may be easily influenced by nonsensical but sensational claims, that the scientific record is set straight.

## References

Evans, David S. "The Great Moon Hoax," *Sky & Telescope*, 196 (September 1981) and 308 (October 1981).

---



**NASA Lunar Digger Device  
1958 photo is of unidentified German engineer who proposed it**

## **World's biggest telescope to prove *Americans really walked on Moon***

by **Robert Matthews**

Science Correspondent

24/November/2002

from [Rense](#) Website

Conspiracy theorists, you have a problem. In an effort to silence claims that the Apollo Moon landings were faked, European scientists are to use the world's newest and largest telescope to see whether remains of the spacecraft are still on the lunar surface.

For years, doubters have claimed that NASA, the US space agency, spent billions of dollars faking the landings to convince the world that it had beaten the Soviet Union to the Moon. A host of supposed evidence has been put forward, ranging from the absence of stars on any photographs taken by the astronauts to the fact that the Stars and Stripes they planted seemed to flutter in a vacuum.

Earlier this month, NASA tried to put an end to the controversy by commissioning a definitive account of the evidence for the landings. Days later, it dropped the idea after criticism that it was wasting money by taking on the lunatic fringe: naturally, this only boosted claims that the space agency was trying to hide something.

The row even boiled over into personal conflict in September when police in Beverly Hills were called in to investigate claims that Edwin "Buzz" Aldrin - the second man on the Moon - punched a conspiracy theorist who accused him of lying about the landings.

Now astronomers hope to kill off the conspiracy theory once and for all by using the Very Large Telescope (VLT) - by far the most powerful telescope in the world - to spot the *Apollo lunar landers*.

Operated by European astronomers in the Chilean Andes, the VLT consists of four mirrors 27ft across linked by optical fibres. It can see a single human hair at a distance of 10 miles.

Trained on the Moon, such astonishing resolution should enable it to see the base of one or more of the six lunar modules which NASA insists landed on the Moon between 1969 and 1972. Any images of the modules would be the first not to have been taken from space by NASA.

Dr **Richard West**, an astronomer at the VLT, confirmed that his team was aiming to achieve "a high-resolution image of one of the Apollo landing sites".

The first attempt to spot the spacecraft will be made using only one of the VLT's four telescope mirrors, which are fitted with special "adaptive optics" to cancel the distorting effect of the Earth's atmosphere. A trial run of the equipment this summer produced the sharpest image of the Moon taken from the Earth, showing details 400ft across from a distance of 238,000 miles.

The VLT team hopes to improve on this, with the aim of detecting clear evidence for the presence of the landers. The base of the lunar modules measured about 10ft across, but would cast a much longer shadow under ideal conditions.

Dr West said that the challenge pushed the optical abilities of one VLT mirror to its limits: if this attempt failed, the team planned to use the power of all four mirrors.

"They would most probably be sufficiently sharp to show something at the sites," he said.

Dr West insisted, however, that the decision to examine the landing sites was not driven by the conspiracy theory.

"We do not question the reality of the landings," he said. "It is more for instrument-testing purposes."

Supporters of the conspiracy theory welcomed the news that astronomers are to photograph the landing sites.

**Marcus Allen**, UK publisher of *Nexus magazine* and a long-time advocate of the theory, said:

"I would be the first to accept what they find as powerful evidence that something was placed on the Moon by man."

He added, however, that photographs of the lander would not prove that America put men on the Moon.

"Getting to the Moon really isn't much of a problem - the Russians did that in 1959," said Mr Allen. "The big problem is getting people there."

According to Mr Allen, NASA was forced to send robots to the Moon and faked the manned missions because radiation levels in space were lethal to humans.

"We know that no lead shielding was carried on Apollo, so how were 27 astronauts able to survive a journey of several days to and from the Moon?"

Dr **Duncan Steel**, a space scientist at *Stanford University*, said that the supposed radiation hazard is a myth spread by conspiracy theorists.

Dr **Robert Massey**, an astronomer at the *Royal Greenwich Observatory*, said that the conspiracy theorists are unlikely to be deterred by photographic evidence.

"Even if the VLT does see something, I suspect it won't silence them. In science we can never totally prove anything - but we can prove things beyond reasonable doubt."

**Return to Moon Bases**  
**Return to German Disc Aircrafts**

→ Exopolitics Journal Vol3:4 ←

# India Cosmology Revisited

...in The Light of Current Facts

by **Come Carpentier de Gourdon**

June 2011

from [ExopoliticsJournal](#) Website  
[Spanish version](#)



#### About the Author

Come Carpentier De Gourdon is currently the Convener of the Editorial Board of the World Affairs Journal, a quarterly publication dedicated to international issues, sponsored by the Kapur Surya Foundation (a co-sponsor of the "World Public Forum for Dialogue of Civilisations") New Delhi, India. He has been associated with various businesses and not-for-profit organizations. They include the Nuclear Disarmament Forum and the Foundation for Global Dialog, Zug, Switzerland (in 2001-2002), the Tissot Economic Foundation of Neuchatel, Switzerland (1991-2000), the Global Commission to Finance the United Nations (from 1994 to date), the FEGAWERK Group of Companies, Switzerland (1991-1999), the Business Council for Sustainable Development (BUSCO, Paris, France, 1994-1995), Planet India Ltd. of New Delhi, India (from 1995 to date), the Conference of World Affairs of the University of Colorado in Boulder, USA (1985 to 1988), Orbit Productions, Washington D.C., USA (1987 to 1989), the Together Foundation for Global Unity of Caracas, Venezuela and Boulder, Colorado (1990-1992) and the Swiss Academy of Technical and Engineering Sciences (SATW) (1992-1993) among others. He is the author of numerous papers including a presentation at the 2006 World Public Forum on "The Case for Exopolitics: Ushering in a Cosmic Dialogue." His website is: <http://www.comecarpentier.com/>

## **Abstract**

Indian mythological and historical literature, written over the course of well over three to four thousand years, contains a number of fairly detailed references to and descriptions of non-human, "semi-divine" living beings and of various visible and invisible realms which in some cases appear to be located in other dimensions of reality or in parallel universes.

There are also accounts and reports of aircraft and space faring vehicles, as well as of very powerful weapons of war capable of bringing about massive destruction over very large areas.

Those vehicles and tools are used by both deities and human beings according to those stories.

On the other hand, contemporary scientific evidence and official conclusions in various countries point out that extremely advanced spacecraft and humanoid but seemingly non-human (probably "trans-dimensional") beings are active on our planet and in outer space.

This paper establishes a connection between those separate findings and suggests that an updated and expanded vision of [the structure of the universe](#) is required as the present, classical cosmology is inadequate to account for many observations.

## **Introduction**

Myths and legends are not accepted as factually real according to the methods, criteria and notions of science.

They are regarded either as imaginary stories designed to provide ritual and moral teachings as well as cultural entertainment to society; or as fictionalized and symbolic accounts of ancient events, whose original character and circumstances were partly forgotten.

The Euhemerist school of thought (named after the 4<sup>th</sup> century Greek mythographer [Euhemerus](#), in line with the Skeptic approach of the Cyrenian philosophers) regards gods and super-natural beings as latter-day depictions of historical human figures who were, in the course of centuries or millennia, invested with divine or heroic supra-human attributes.

Though there is evidence that those socio-historical interpretations are justified in many if not all cases, there is also ground for considering another way of reading those stories, without prejudice to the previously described exegeses. That would be the open-minded, objective method which looks at the descriptions and events reported in mythology and sees how they might relate to current or recent events for which we have scientifically admissible proof.

**Erich von Daniken** is perhaps the best known researcher and author to have carried out this task though inevitably, many of his interpretations, which are so bold as to be on the outer fringe of speculation, have been met by controversy and often outright dismissal among mainstream scholars.

Given that myths and legends are known to be legible at various levels, from the literal to the psychological and metaphysical, not to forget the historical dimension, we will not be doing a disservice to this ancient lore by accepting it in principle, as a bona fide account of actual happenings even though obviously, literary embellishments and inevitable inaccuracies were inserted in the course of time.

What are the factors that make it worthwhile and even necessary to take this factual, unprejudiced view?

Firstly, the Indian traditional systems of cosmogony, metaphysics and cosmology took shape over many centuries, if not millennia and were held to be factual and accurate in several civilizations within the greater Indian area of influence. They are still respected and influential in the country, adjoining areas and increasingly, in regions of the world where various aspects of Hindu-Buddhist culture such as yoga and religious practices are becoming known and followed.

On the other hand recent scientific discoveries tend to support some of the conclusions and observations recorded in many of the Indian philosophical and technical texts.

Secondly, many repeatedly observed and scientifically confirmed phenomena do not find a satisfactory explanation according to the current scientific principles and theories while they are accounted for in the traditional Indian cosmology.

Therefore, it may be useful or even necessary to revisit the cosmos depicted by the [Vedic and Puranic texts](#) in order to make sense of some enigmatic aspects of the universal reality that confronts us.

## Space and Time

“Modern” science evolved under the influence of materialistic rationality which drew its principles partly from Medieval Theologian [William of Occam’s “razor”](#).

An effect of that attitude is that (western) scientific astronomy for one started from the lowest common denominator in terms of its assumptions about space and time and initially discarded the ancient Indian chronologies which were it regarded as outlandishly implausible, especially when compared with the Hebrew Biblical records that placed the creation of the Universe a mere six millennia ago (4004 BC).

In the nineteenth century, astronomers were still very timid in their cosmological estimates and only a few visionaries like astronomer **Camille Flammarion** dared to depict the universe as being *possibly infinite or at least inconceivably large*. Only reluctantly did his successors admit that the Milky Way was a galaxy containing billions of stars and it took even longer to realize that it was just one of a huge number of similar or larger galaxies.

Time scales did not expand easily either in the minds of scientists.

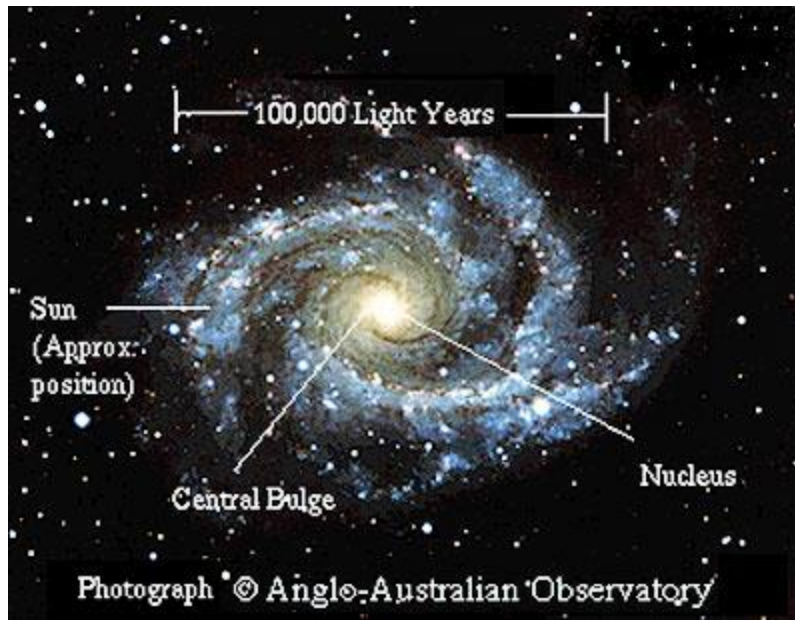

Therefore the orders of magnitudes of,

- [yugas](#)
- devavatsaras
- caturyugas
- devavatsaras
- mahayugas
- manvantaras
- kalpas,

...of Indian Scriptures, encompassing *trillions of solar years* remained practically beyond their intellectual grasp until the advances made in telescopic and astrophysical observation in the first half of the twentieth century gradually reconciled them with the fact that the universe is not only larger than we imagine but also possibly larger than we can imagine or measure.

In the light of science the Biblical record about the cosmos being made in six days by *God* a few thousand years ago appears comparatively primitive and, contrary to the theory of linear human progress, ancient civilizations founded on cosmological myths similar to those of India, China, Africa or the Americas may be said to have regressed intellectually when they adopted the “science” that came together with christianity.

There is evidence that many of the texts compiled and assembled in *the Torah or Old Testament* are derived from much older sources and held a symbolic meaning which was mostly lost when a literal interpretation was promoted.

The estimates provided by contemporary astronomy for the age and size of the cosmos and of its galaxies and stars are now broadly congruent with the numbers found in Indian scriptures. On the other hand the theories of creation and matter expounded in them are still outside the pale of the current scientific worldview which describes them as “mystical visions” or unproven speculations though it cannot actually disprove them.

Yet the fact that some “mythological” annals are uncannily accurate or at least plausible in their mathematical evaluations should prompt physicists to take a closer look at the “Indic” descriptions of the structure of reality.

It can be said in a few lines that the various schools of Hindu, Buddhist and Jain physics teach that there are several parallel fields of reality within our universe, made up of different substances; or, more accurately, of the same substance at different density levels. The underlying stuff, from where all originates, is undefinable, but is generally called Brahman or Prakrti, that can be defined as the original ground of consciousness.

We may detect it in what contemporary astrophysics calls the dark matter of the cosmos which seems to make up some 96% of the total.

From that initial substrate a number of realms emerge, first the causal (karana), then the subtle (sukhma) and finally the



physical or gross (sthula) field of matter, made up of the combinations of the five basic elements - actually “states of the energy field” that we define as ether, fire, air, water and earth - in varying degrees.

Therefore, what we can experience and observe according to our scientific methods is all or mostly in this particular world of matter, called Bhu which is surrounded and pervaded by thirteen other [lokas](#) (the greek word *logos* is derived from the same root, as is the latin *locus*: place), in descending order six higher planes:

- Satya
- Jana
- Mahar
- Svava (the heaven of the devas or shining ones)
- Bhava and seven lower ones, netherworlds, sometimes improperly described as hells:
  - Atala
  - Vitala
  - Sutala
  - Talatala
  - Rasatala
  - Mahatala
  - Patala

Those “concentric” spheres may be regarded as geographic locations situated above or below the surface of Earth or even as physical continents; but these names generally seem to other levels of existence, not topographically removed from ours, but parallel to it, deployed in extra-sensory dimensions that exist beyond the three and half we live in (with time as a half-dimension since we cannot physically reverse it at our level of reality).

Some Buddhist Scriptures, based on the same cosmological system, refer to countless worlds that compose the “chiliocosms” or galaxies spread throughout space.

Man is said to have come into the flesh in this world (the *kamadhatu* or realm of desire) from the higher sphere of the Abhasvara devas (pure light gods). All those planes many of which are invisible and imperceptible to “ordinary humans” are held to be as thriving with life as our own.

They contain their own elements, plants and animals, including some similar in shape and behavior to humans.



The *parallel worlds* are in constant contact with ours because, unlike us, most of their denizens are aware of our existence, can observe us and indeed intrude into our space-time, usually “below the radar” of our conscious awareness.

Naturally, especially as long as they remain in their respective spheres, they escape all criteria of scientific detection since the latter are formulated on the assumption that only perceptible and quantifiable creation exists.

However, certain humans can also accede to those other worlds, either due to special gifts and powers or through intensive psychic and spiritual training or magical practices but they thereby automatically violate the rules of the scientific game, set in the age of Enlightenment, so that their experiences are ignored as being invalid by definition.

Revealingly, the criteria of proof that are generally upheld by scientific methodology are not deemed sufficient in cases which violate the laws of nature as defined by "science".

In this attitude, the "knowledge establishment" remains faithful to the dogma:

*Non potest sicut non est*: it can't be, therefore it is not, or in a milder version "extraordinary claims require extraordinary proof".

The spatial map of the cosmos we have just outlined is reflected in a chronological order that we have already alluded.

Each cycle of life is said to be divided into four ages of decreasing duration and virtue: the Satya or Kriti, Treta, Dwapara and Kali yugas. As Creation drifts or outflows farther away from its source, its purity decreases and its light wanes.

The actual duration of the yugas, which is interpreted diversely depending upon the sources being consulted, is less important than the notion that as the age declines, spiritual power fades and technology becomes increasingly prevalent and sophisticated.

Since we are in the age of Kali that we entered more than five thousand years ago, our spiritual and psychic faculties are said to have dwindled to a mere shadow of their original power, we are witnessing the rise of advanced technologies that enable us to venture always deeper into outer space and visit other planetary bodies.

The Puranic scriptures say that while in the Satya Yuga, humans had all the gifts that we now regard as supernatural.

In the Treta Yuga they had to use mantras (or verbal formulas) to access those powers, or control their [Vimanas](#) (flying vehicles) and also their weapons (astras and shastras) because war had become a fact of life then. In the Dvapara Yuga, they needed yantras (magical signs and drawings).

Science and technology are mentioned and even described but they are regarded as crutches built by degenerating mankind in order to make up for the loss of natural faculties.

In the Kali Yuga, predictably machines (kritakas) must be built and operated with metals and other material substances and propelled by physical energy generated by burning or otherwise harnessing material substances.

Mantras, Tantras and Yantras do still exist, although many were reportedly lost, but since their power lies at the invisible or at least mathematically unquantifiable levels of spiritual and psychic existence, they are not deemed relevant by our technocratic and intellectual leaderships. The power of our technologies is hence, paradoxically, rooted in our limitations as a species which is described as being a shadow of its glorious original self.

After reporting uncritically what is alleged in those scriptures, we may point out that similar accounts of evolution are found in many other sacred and ancient texts throughout the world.

There is a hoary, quasi-universal tradition behind the belief that modern mankind is the descending incarnation of much higher life forms, not the result of a long and gradual linear progression as the modern *Theory of Evolution* (TOE) holds.

Other major implications of the Indian traditional history of the world are that the material means for conveying knowledge and for record keeping, such as writing and, more recently, taping or filming were not needed in earlier times since oral or telepathic communication and memorization were far superior methods for the acquisition and preservation of information and above all wisdom.

Thus the progress made in those areas does not denote a rise from barbarity to true humanity but constitutes instead an imperfect substitute for the lost powers and abilities of our remote ancestors or predecessors on this planet.

The extraordinary quality and depth of the remaining Vedic texts, apparently consigned to memory in an oral form for untold centuries, seem to confirm the refinement and elevation of the civilization which preserved them with flawless precision down to our days.

The contention that they originated in a highly evolved culture endowed with now lost spiritual and cognitive techniques is hence plausible and it finds an echo in Plato's doctrine who *describes the invention of writing as an effect of the loss of primeval wisdom.*

## Other Worlds and Their Inhabitants

Contrary to modern humans, the other creatures described throughout Indian ancient and medieval literature, have not declined but remained in their original condition, with all the powers and attributes assigned to them.

Although they may have made themselves more discreet, perhaps simply because our growing physical "density" has robbed us of most of our extra-sensorial means of perception. As said earlier, the materialistic, skeptical or agnostic mindset that Western societies have exported all over the planet in the last two or three centuries has played a major role in deporting all traditional lore to the "no man's land" of primitive legends or ethnic fiction.

However since the origins, Indian texts record that human beings mixed and mingled with the various gods, genii and "demons" (in the greek, ambiguous or "good" sense of the term) and often inter-married with them, giving birth to hybrid beings.

Some highly meritorious and gifted men and women became gods and rose into the higher heavens while others were semi-demonic and moved freely between various worlds. Certain super-natural creatures are said to descend from apparently human ancestors, like the rakshasas who were begotten by the great Vedic [Rishi Pulastya](#).

The latter is identified as one of the stars in the [Big Dipper constellation](#) (Pheida in modern astronomy) and hence his own nature is both earthly and celestial, as are the other six demiurgic rishis of Indian cosmology. The Dipper or Great Bear points to the North Pole or cosmic axis where Vedic cosmology locates the holy Meru mountain, the home of the gods.

There lies the origin of the famed "Indo-Aryan" arctic symbolism adopted in certain esoteric circles of 19<sup>th</sup> and early 20<sup>th</sup> century Europe.

The sciences of yoga and tantra are known to give their advanced practitioners the ability to explore other dimensions and to dwell at least temporarily in them, depending upon the level of mastery achieved in the techniques. Thus, those parallel universes may be closed to most ordinary humans but are not so mysterious to those who know the teachings of the seers.

Among the beings who live in them, some of the closest to humans are the,

- pitris
- pisacha
- bhutas
- yakshas
- nagas
- gandharvas
- kinnaras
- ganas
- rakshasas
- asuras
- garudas
- suparnas
- vidyadharas
- devas,

...in no particular order.

Though not all of them are described precisely, there are enough references to them in the Vedic and Puranic texts as well as in the Ramayana, Mahabharata and in later texts to form a fairly complete image of what they represent.

Many scholars have concluded that those apparently super-natural creatures are in fact totemic characterizations of

various tribal populations and foreign nations but, aside from that naturalistic interpretation, we should also look at the possibility that they are or were in fact really in existence, as many current observations might well confirm.

[The pitris](#) are among the closest to living humans. Like the greek *Manes* they are the souls of the dead ancestors and they inhabit [the astral dimension](#). Pisachas and Bhutas are akin to the ghosts or spirits of western lore and sometimes have the characteristics of goblins.

[Yakshas](#) are usually protective village spirits and often act as guardian deities of underground treasures, groves or springs. Their monarch Kubera, who also rules over the gandharvas is the god of wealth and metal and he is the “emperor” of the Northern or polar quarter.

The yaksha kingdom, said to lie around Mount Kailasa in the Western Himalayas, is called Alaka and is rich in gold.

In that same region are the Garudas, mythical eagle-men or flying humanoids, said to have white faces, golden bodies and large red wings, who hail from Hiranmaya and who are rather similar to the Suparnas, also human faced and winged.

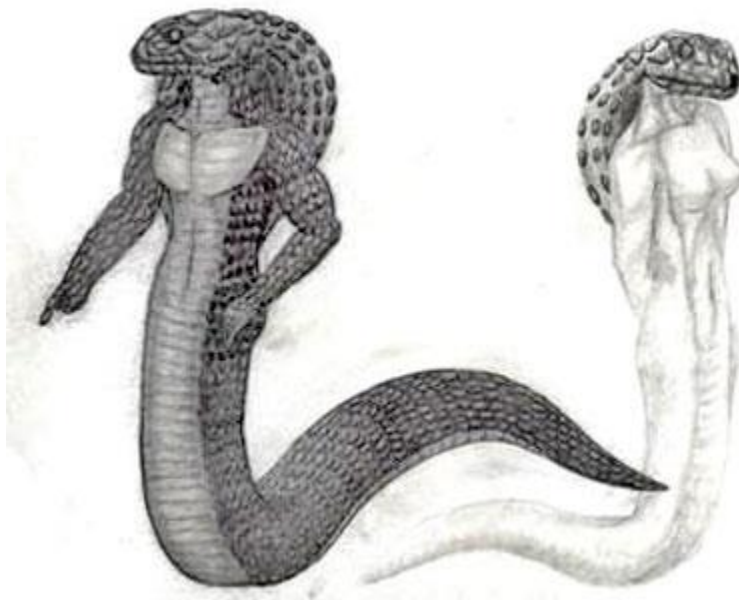

[The Nagas](#), often situated in the same broad region - and whose subterranean abode (the Patala) is said in Tibet to be reachable through a secret opening located under the homonymous temple-palace of Lhasa (the Potala) - are described as serpents or dragons but can assume human forms and like several of those fabulous beings are in fact “shape-shifters”, if we choose to borrow a term of contemporary science-fiction.

The Gandharvas, at once warriors and musicians serve the devas and are divided into twenty seven tribes, many of which reside in the enchanted gardens of Chitraratha, north of Kailash. They are also aerial beings whose ancestor or ruler is said to be the great musician rishi Narada.

If the Apsaras evoke both the Naiads, Nereids and Valkyries to the western imagination by their appearance and connection with water and heaven, the kimpurusas are lion-faced anthropomorphic creatures and the kinnaras are horse-headed like Hayagriva, the Hindu and Buddhist “demonic” icon who is often called their leader.

They have a clear etymological link with the greek Centaurs (kentauri).

Their consorts, the kinnaris, however are half-bird, half -woman. The ganas are dwarfish, often misshapen beings who are associated with underground minerals and secrets, like their Western equivalents (leprechauns or goblins) and their name relates them to the Arab Jinns, said to be “made of pure fire without smoke” (astral light, possibly).

On a higher plane are the higher “gods”, the Rudras, Maruts, Adityas and Vasus who dwell in subtler realms.

Significantly one of the Adityas (children of Aditi: infinite space) is Tvastr, the architect and builder of the universe and the carpenter of the flying vehicles that carry the gods across heaven.

Among the Asuras, the powerful rivals of the “[shining ones](#)”, is Maya (“the maker”), another cosmic demiurge who crafted the Pushpaka Vimana, described in the Ramayana as the flying chariot of Kubera “resembling a bright cloud in the sky”, taken from him by his envious and ambitious brother Ravana, king of the Rakshasas of Lanka.

The rakshasas are also super-human beings who have all sorts of magical and prodigious powers. Their name comes from the root raksh: to protect, indicating that, although they are regarded as generally cruel and destructive forces in classical Hinduism, (though capable of “redemption”) originally they were ambivalent as are most other kinds of divine or supra-human beings.

Even more enigmatic are the vidyadharas (holders of wisdom), semi-divine beings, often located in remote Himalayan regions and described as possessors of many fantastic abilities like flying, changing shape and becoming invisible. They are sometimes cited as attendants of Rudra Shiva, the Cosmic Mountain Lord who is “The Destroyer of worlds”.

Their monarch is Kandarpabali, according to [the Hitopadesha](#) and they are the guardians of tantric wisdom and “supernatural” science.

Many of those beings are indeed associated with the great mountain ranges which border India on the North and surround the polar Meru according traditional geography. While many scholars interpret this nomenclature as describing, in a mythological garb, to tribal populations and kingdoms located in the upper Himalayas and on the Tibetan high plateaux, others tend to see them as imaginary creatures with which poetic fantasy populated the inaccessible snowy fastnesses that lay on the horizon.

However one can also consider the possibility that there may have been groups of beings “descended from above” or from their boreal abode on those highlands, as the original and pre-Buddhist shamanistic tradition of the Bon religion of Tibet records.

The Bon books trace their origins to Dropha **Shenrab Miwoche** who, more than 18,000 years ago came from the *hidden realm of Shambhala* flying on the Tagzig Olmo Lug Rig (space) and taught the original form of the Vedic religion handed down to him by his own teacher Shelha or Shiwa Okar (perhaps the Indian Shiva).



The [Bon myth](#) about the initial source of all wisdom seems to have inspired the Buddhist doctrine of the hidden Kings (or Kulikas) of Shambhala who have their seat in the wondrous city of Kalapa where they preside over the secret rite of the Wheel of Time (Kalachakra).

In all there will be thirty-two lords of Shambhala, each one ruling for one century, from the first, Suchandra (Dawa Sangpo in Tibetan) to the final one, Raudra Chakrin or Trakpo Chokhorchen who will come in the twenty-fourth century of the common era, with the contemporary one being Aniruddha or Nagakpo, the 21<sup>st</sup> in the line.

In the Tarim basin of Chinese Turkestan and outlying areas as well as in Mongolia, there are many related legends about Shambhala and Agartha and some intriguing archeological remains have been found (dropa stones and mummies at Baian Kara Ula), leading Chinese archeologists to speculate about “out of this world” origins.

It is in that broad region that Taoist cosmology situates the Hsi Tien, the Western Paradise of the Lady of the golden plums of immortality Hsi Wang Mu. It is said to be the Central Asian Holy Land of Belovodye described by the Orthodox Old Believers, Raskolniki.

The French esoteric philosopher **Saint Yves d'Alveydre** in his various books, particularly in his *Mission de l'Inde en Europe*, written in 1886 under the inspiration of certain Hindu spiritual teachers, claimed to have visited Agartha in his astral body ten years earlier and to have been initiated to his sacred language, called Vatan.

He describes it as the nerve-centre and main sanctuary of Paradesa:

“the highest land” in Samskrt, (the name from which paradise is derived, according to him).

He hints that this realm is partly subterranean, beneath the Himalayas and at least partly hidden in another dimension, which makes it invisible and inaccessible to most people who are not invited into it.

Saint Yves gives several other details on this mysterious empire whose population he evaluates at about twenty million.

He adds that it is surrounded by various tributary kingdoms, ruled by their respective Rajas and that this confederacy numbers forty million people in all. The ruling hierarchy consists, in ascending order of yogis, pandits, bhagwandases (who are 360) and above them, of twelve world gurus, headed by the supreme triumvirate of the Brihatma (depository of the spiritual authority), the Mahatma (entrusted with juridical power) and the Mahanga who is the executive enforcer.

Saint Yves who was socially prominent and enjoyed great respect in esoteric circles, was so confident of the knowledge he had gained about Agartha that he wrote letters to the Pope, Queen-Empress Victoria and Tzar Alexander III of Russia to offer his introduction to the governors of that hidden kingdom in order to allow the Mahatma and his court to come out in the open and make available the stupendous treasury of knowledge accumulated in the great underground libraries kept by the scholars of Agartha all over the planet.

He wrote that all the records of times past since the dawn of the ages and scientific knowledge immeasurably more advanced than that of his contemporaries, was available in those archives, compiled in the last fifty five thousand years since the days of Manu.

He cited the 18<sup>th</sup> century Swedish mystical theologian and polymath **Emmanuel Swedenborg**, who had described seeing through his extrasensorial faculties the annals of forgotten human history from the origins, buried deep beneath the steppes of Central Asia.

The tradition recorded by Saint Yves influenced a number of later esoteric researchers, such as **Rene Guenon** and **Ferdinand Ossendowski** as well as **Nicholas Roerich**.

All wrote about or sought the abode of the “king of the world” somewhere between the Himalayas and Mongolia.

D'Alveydre indicates that the denizens and rulers of Paradesa are human, though they exist at a very advanced stage of evolution which lends them the attributes of divinity; but he notes that in the course of their investigations of the universe, both beneath the earth surface and into “the highest heavens”, the Agarthans have discovered various intelligent species, some of which are similar to humans while others seem to be hybrids of men and various types of animals.

He further says that they use “dirigibles” (zeppelins) to explore the sky and the regions above but that could be an allusion to spacecraft of a type unknown to him who, in his age, could only understand the principle of aerostats since the principle of “heavier than air” aircraft was regarded as unrealistic by most.

Also linked to the lore of Agartha are the legends of the underground sacred cities of Shonshe and Shangwa in Eastern Turkestan, refuges of the ancient celestial Uyghur race which is believed to have left the visible world after a great cataclysm many thousands of years ago.

In the Mahabharata the abode of the Devas is given as [Uttara Kurus](#), North of Tibet and of the kingdom of the gandharvas (generally equated with modern Afghanistan and Central Asia).

It may be the Samskrt version of Homer's *Hyperborea*.

## Heavenly Vehicles

As we have seen, some of the fantastic creatures alluded to in the previous chapter, whether fully "divine" or at least half-human are said to fly in heavenly chariots and to hold extraordinarily powerful weapons as well having the ability to carry out many magical actions, such as changing shapes, increasing their sizes to colossal proportions or inversely, shrinking to the scale of a gnat or an atom and so on.

Such abilities are however also accessible to the greatest yogis so that there is no clear separation between humans and other living beings.

The weapons of the immortals, which are gifts of the gods or acquired through a combination of technical knowledge and extraordinary penance and mental concentration (tapas) have practically infinite capabilities, as demonstrated through many Puranas as well as in the course of the great epics.

- the Agneyastra produces a very intense fire which cannot be put out and sears everything to ashes
- the Varunastra triggers diluvian rains which flood an entire country
- the Suryastra creates a blazing light that blinds and paralyzes all who see it
- the Vayavastra unleashes tornado-like blasts of air that can overthrow the strongest buildings and ravage the landscape
- the sanmohana induces the target population or army into a collective trance or hallucination
- the Tvastra triggers such confusion and panic that those exposed to it may fight with each other to the death without reason

The Sudarshan chakra (or fiery wheel) of Vishnu is irresistibly destructive but can only be used once because on second launch it boomerangs and can annihilate he who shoots it as well as his troop.

It is an "intelligent" missile as the name *sudarshan* (all seeing) indicates and that feature irresistibly brings to mind the celestial wheel "covered with eyes" [described by Ezechiel](#) in his Biblical Prophecy.

The kaumodaki is Visnu's mace whose effects are also devastating and irresistible. The Indravajra is a beam of searing light, a "laser" thunderbolt which is directed and shot through a circular shield acting as a sort of reflector.

Finally the Narayanastra, the Pashupatastra and above all the Brahmastra are so lethal that they extinguish all life in the area in which they are unleashed and cause long-term and fatal damage to the ecosystem.

There is no need to remark that many of the features and effects of those *mythical weapons* are very similar to the capabilities of the ballistic, chemical, meteorological, electromagnetic and nuclear arms that have been developed by the most advanced military powers or are envisioned by strategic planners and scientists for the future.

Though the stock response of academics is that such descriptions merely reflect the breathless imagination of the ancient bards, the abundance of uncannily technical allusions appears to indicate the transmission of a very old experiential knowledge.

For instance, in [the Mahabharata](#), Krishna, when his opponent Saubha makes himself invisible on the battlefield, shoots at him an arrow or missile that is guided by sound to hit its target.

[Vimanas](#) are of many sorts and are described throughout the long and rich period of Indian ancient and medieval literature. In the Mahabharata their builders are said to be the yavanas, a western people that has been identified with the Greeks by many later sources but that probably refers to a large family of Western Indo-European nations or tribes.

However, the minority religion of Jainism which is extremely ancient, has recorded that some of its Enlightened Guides (Tirthankaras) came to the world on jayanta Vimanas.

In later texts some twenty-five shapes of Vimanas of diverse sizes, from the tiny to the gigantic (celestial cities) are described, some in fairly great details. In the language of architecture, a Vimana is a tower or building that has seven stories and is the specific name of the spire which arises above the sanctum (garbhagriha: house of the egg or germ) of a temple.

More recent [Sanskrit treatises](#) such as the Visnudharmottaram, the Aparajitaprachcha, the Abhilasirtharta Chintamani and the Narada and Kasyapa Silpa Sastras contain information on the construction and performance specifics of Vimanas.

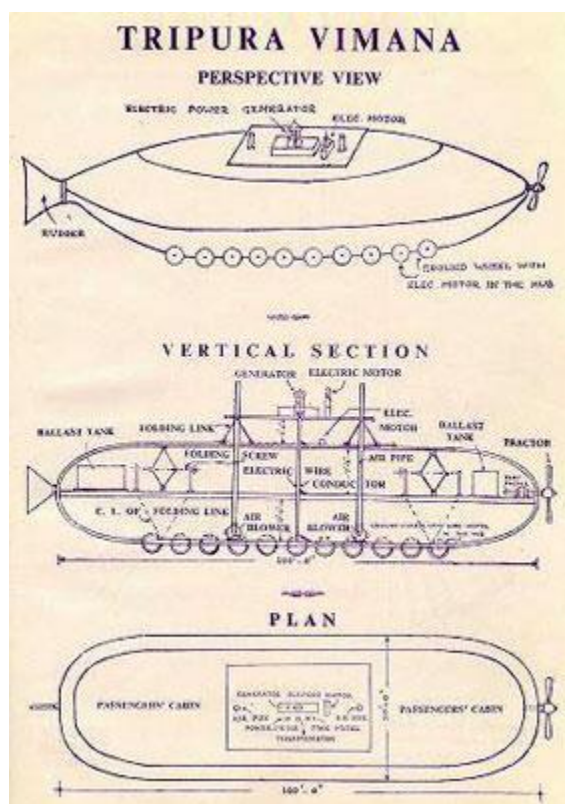

The best known source, the [Samarangana Sutradhara](#), attributed to 11<sup>th</sup> century King **Bhoja of Dhara** and his vast scientific and literary academy has the following to say on those space vehicles:

“Strong and durable must the body of the Vimana be made, like a great flying bird of light material.

Inside one must put the mercury engine with its iron heating apparatus underneath. By means of the power latent in the mercury, which sets the driving whirlwind in motion, a man sitting inside may travel a great distance in the sky.

The movements of a Vimana are such that it can vertically ascend, vertically descend, or move standing forwards or backwards. With the help of machines, human beings can fly through the air and heavenly beings can come down to earth”.  
(chapter 1, 95-100)

The same text describes bio-mechanical robots used as guards and soldiers (ibid., 101-107),

From the aforesaid we can conclude that Indian sacred, historical and technical literature knows of many different worlds and dimensions and of several types of beings that generally move back and forth among those dimensions, just as we probably do unconsciously.



Ancient India also kept the memory - perhaps refreshed by occasional or frequent observations - of artificially built spacecraft powered by psychic or mechanical energy, and capable of moving in the air as also on and beneath the water.

We can now do a rapid review of relatively recent and contemporary reports which tally with the Indian legends, annals and chronicles and thus give reason to believe that these ancient accounts were based on real experience or at least on visual evidence.

## Modern Records and Observations

Even if we refrain from going back to the 19<sup>th</sup> century or to even older times where some reports (and even a few early photographs) of unknown aircraft and “non-human” creatures descended from the sky exist but for which hard proof may be lacking, we must recollect some significant statements, made by important figures of science and by military leader, indicating beyond reasonable doubt that an awareness of “higher beings” has existed for well over a century among the technocratic elite of our societies.

It appears that for some unclear reason, a super-human, non-earthly or at least non-earthbound presence manifested itself to a number of people in both Europe and America shortly after the First World War.

As if that great civilizational crisis, which marked the end of an era, had triggered intense interest “from above”. UFO sightings and even landings were reported in the USA and in Germany and some secret societies were formed, purportedly under the guidance of otherworldly beings.

The most influential were the rumored but not historically established *Black Sun and Vril Gesellschafts* in Bavaria and the now well known [Thule Group](#).

The [Vril Society](#), called after the cosmic energy of life that is equivalent to Prana in Samskrit, drew its inspiration from a young and beautiful Medium, Maria Orsic, who claimed to be in contact with a very advanced group of beings from a planet around [the Aldebaran giant star](#) (*Rohini* in Samskrit astronomy) within the Taurus constellation.

Those beings allegedly sent her periodic messages and thereby conveyed high-level scientific information, designed to enable the members of the group to produce inexhaustible, non polluting energy and build aircraft capable of flying at virtually unlimited speed in order to reach the stars.

The data channeled by **Maria Orsic** and other “Vrilerinnen” (young female mediums) were interpreted by Professor **W. Schumann** from the Technical University of Munich and used to try building the “flying saucers”, from a first unsuccessful prototype tried out as early as 1922 over a Bavarian lake.

The program was later taken over by the Third Reich under the purview of its SS E-IV Division, as some members of the Vril and Thule groups (closed down by the Gestapo, as most other secret societies) became high-ranking officials of the new regime.

Though much controversy surrounds the extent and rate of success of the [“Haunebu” and “Vril ships” building program](#), there is no doubt that the Germans experimented throughout the war years with “flying disc” gyroscopic and turbojet technologies,- side by side with the more conventional V1 and V2 rockets built by **Willy Ley** and **Wernher von Braun** - through such craft as the RFZ-1, first tested in 1934, and the later and superior RFZ-2 which is believed to have achieved impressive performance levels.



SS General **Hans Kammler**, who organized the use of prisoner labour from the concentration camps for the space weaponry program headed by General Dornberger, reportedly supervised the R&D effort into anti-gravity propulsion.

It is significant that the propulsion technology is said to have consisted essentially in the assembly of "[Thule Tachyonators](#)", spheres of vertically rotating mercury, in line with what some of the Indian Shastras describe in the Vimanas.

As Professor **Hermann Oberth**, one of the fathers of the German and later American space programs and the major mentor of von Braun, put it succinctly, they were helped by "people of other worlds".

In parallel with the German research effort, there is documentary proof that Benito Mussolini was briefed by his officials on the fall or landing of a UFO (an *aeromobile sconosciuto*: unknown aircraft) in the Veneto province of Italy in late 1932 and personally ordered the "leaden cast" of his own telegraphic instructions to be destroyed, as well as "total silence" to be kept, further instructing the state media to describe the object as a meteorite in their releases.

Evidence for this is supplied in the form of facsimiles of the telegrams from the Dictator reproduced in the book "Contattismi di Massa" (2005) by Stefano Breccia (publish in English as "Mass Contacts" - Authorhouse, 2009).

Mussolini - who soon afterwards created the Research Unit RS/33 dedicated to new technologies, with the participation of Guglielmo Marconi, the inventor of the Radio - would turn out to be one of many statesmen to be confronted with material evidence of this kind; and, like almost all others, he treated it as a top secret matter of national security.

A semi-ironic allusion to the clandestine discovery can be detected in the Duce's famous speech to the Federation of Fascist Trade Unions at Teatro Adriano in Rome on February 23<sup>rd</sup>, 1941 in which he said:

"In any event, it is more plausible that the United States (would be) invaded, rather than by troops from the Axis, by the denizens of planet Mars, not well known, but it seems rather warlike who shall come down from sidereal space on unimaginable flying fortresses."

German ballistic and space-related research was obviously of utmost interest to the main victors of the war, the USA, the Soviet Union and Britain; and they took great pains to identify and "mop up" the evidence and equipment they found when they invaded the country.

The American and Soviet space programs can be said to have arisen from the ashes of the Third Reich's achievements and plans for winning the mastery of airspace and venturing out of the atmosphere.

Skeptics have argued that the Vril is the name of a psycho-physical cosmic force first described in the 1871 novel "[Vril - The Power of the Coming Race](#)" by British writer and occultist Lord **Bulwer Lytton**, the famed author of the *Last Days of Pompeii*; and that, being a fictional name could hardly have been adopted as a symbol and a goal by a German occult research society.

However it must be noted that the Vril, the essential energy in light sound and electro-magnetism which Bulwer Lytton associates with a gigantic race of Indo-Aryan origin, living in a network of deep underground caverns and endowed with

“Enochian knowledge”, was held to be real by eminent scholars of that period, not to mention other occultists like **Helena P. Blavatsky** and her theosophist colleagues.

For one, the Indologist **Louis Jacolliot** who served as France’s Consul in Calcutta in the second half of the 19<sup>th</sup> century, mentioned the Vril as the invisible power tapped by the Jain initiates he met in Gujarat and Mysore and described in his book *Traditions indo-europeennes* (1876), proving that the name was used in a non-fictional context to account for real phenomena.

Another reference to the Vril in an Indian context is found in the writings of Saint Yves d’Alveydre and I have personally heard testimonies from at least two persons, otherwise quite unaware of the above literature, who had heard from their relatives during the Second World War about secret weapons being developed by the German leadership and made possible by the discovery of Vril energy.

Such contemporary accounts show at least that the stories had spread in German and Italian civil society and there may have been some fire behind that smoke.

## The Polar Enigma

The German connection with an “Alien power” before and during World War II remains a matter of conjuncture and speculation until more documentation is found or made public.

A puzzling statement was uttered by Reich Admiral **Donitz** during his trial at Nuremberg to the effect that the Reich had kept “an invisible fortification in the midst of the eternal ice”, interpreted by many as a hint of a remaining secret Nazi base near [the South Pole](#).



In this regard some intriguing clues can be retrieved from well established events.

In late 1946, barely a year after the end of the War, when “ghost rockets” were being reported by the OSS (the precursor of the CIA) in Sweden, U.S. Secretary of Defense **James Forrestal** commissioned for [Operation High Jump](#) to Antarctica a large armada, consisting of two large vessels, amphibious command ship, USS Mount Olympus and the aircraft carrier USS Philippine Sea, 13 support ships, 2 seaplane tenders, 15 other aircraft, 6 helicopters et al. manned by 4700 men and commanded by the pioneer of polar exploration, Admiral Richard Byrd.

The operation, surprisingly large and well armed for a “scientific” mission in an uninhabited part of the world was to last until the fall of 1947 but it was abruptly recalled in early March after apparently meeting with something unexpected and quite upsetting.

A reported secret diary of [Admiral Byrd](#), signed December 24<sup>th</sup>, 1956 surfaced several years after his demise on March 11<sup>th</sup> 1957. There has been so far no confirmation of its authenticity but some cryptic statements made by Byrd on his

return journey from Antarctica, would seem to lend it some plausibility.

Byrd's interview with journalist Lee von Atta of INS (International New Service) and carried in the Chilean newspaper El Mercurio on March 5<sup>th</sup> 1947 reads as follows:

"Admiral Byrd warned today of the necessity for the USA to adopt protective measures against the possibility of an invasion of the country by hostile aircraft proceeding from the polar regions".

On the reasons for terminating the expedition six months ahead of schedule, he said:

"The most important of the observations and discoveries made was of the present political situation as it relates to the security of the USA" and he called for "the country to remain in a state of alert and watchfulness. We are abandoning the region after making important geographical discoveries".

Given that the U.S. was at the time the sole nuclear power - the USSR would spring a major surprise in August 1949 by detonating its own atom bomb - and the absolute winner of the recent global conflict while most of the world, including Western Europe, China, Japan and the USSR, lay in ruins or was still under colonial rule or American occupation, the warning given by Byrd is not easy to explain.

The Soviet Union had already become the new enemy, but America could hardly fear the prospect of waves of Red Army bombers going all the way down to the South Pole on their way to North America and the Pentagon had more than enough means to repulse any "Bolshevik" air raid.

In all probability, Byrd was referring to a clear and present danger that was not Soviet and which he could not publicly identify.

If we accept his secret diary as genuine, then we must believe that, according to his own words, as he flew over Antarctica from Base Camp "Little America IV" on Whales's Bay, on the 2<sup>nd</sup> of February 1947 he was "intercepted" and escorted by "disc shaped craft" that took him to a sprawling underground facility, called "the domain of Arionni" where he met the leader of a mysterious Scandinavian-looking group of men, who spoke German-accented English and who warned him about the trials to be faced by mankind in future decades.

Byrd further records in his diary that on his return to the USA, he submitted his secret account to Forrestal and was debriefed at the Pentagon for six and a half hours on March 11, 1947.

## **A Rising Presence**

That year which saw the independence of India and Pakistan, the creation of Israel and several other major international developments, was especially eventful on the "alien" front.

It is well known that in June of that year, three months after Byrd's return, many American newspapers carried the report of Aviator [Kenneth Arnold](#) about sighting a squadron of crescent shaped "flying wings" silently gliding "saucer-like" in the air over the State of Washington at 1200 nautical miles an hour.

He was a highly credible and expert witness so that his testimony was unquestioned as there was no official policy yet to deny UFO reports.



Between the 4<sup>th</sup> and the 6<sup>th</sup> of July, one or more craft, apparently crescent-shaped as well, [crash landed or were brought down in the desert of New Mexico near Roswell](#) in the general area of the Los Alamos, White Sands and Alamo Gordo (the nerve centre of the still ongoing Manhattan Project), as announced by the local army spokesmen, reported in the newspapers and on the radio, triggering a flurry of activity within the U.S. Government which promptly ordered the concerned military authorities to issue retractions and rushed by Executive Order the passage of a draconian and secretive National Security Act in the fall of that year.

Whether coincidentally or not, Forrestal's 3000 page day to day journal skips the period between July 3<sup>rd</sup> and 14<sup>th</sup> completely. Subsequent UFO alerts and "crashes" were thence dealt with the same mixture of barely concealed alarm and stringent censorship.

In September, the Strategic Air Command sent a wing of B-29 bombers on a mission to the Arctic, basing them at Fort Richardson, Alaska, possibly in response to Admiral Byrd's cautionary warning about the danger of attack from the poles. Like the records of Operation High Jump, the goals and findings of that mission were classified.

Less than two years later, the circumstances of Forrestal's mental breakdown and subsequent death by suicide in circumstances that were never properly investigated, while under 24 hour watch at the Bethesda Naval Hospital, provide support for theories about a major and ominous secret that may have been suspected by the American leadership during the War and at least partly discovered by Byrd during the *High Jump Antarctic mission*.

That secret has been kept since by certain persons and agencies in the U.S. government, if we judge by the amount of indicative evidence available in public records.

It has been established by his biographers that the ex-Secretary of Defense was under heavy stress on 28<sup>th</sup> March 1949, when President Truman made him tender his resignation, at which time the Secretary of the Air Force, Stuart Symington told him in confidence something which seems to have pushed him "off the edge".

The very next day Forrestal was flown to the house of future Defense Secretary **Robert Lovett** in Florida under military supervision, placed under the care of a Navy psychiatrist who heavily medicated him, and then checked into Bethesda on April 2<sup>nd</sup> as an in-patient; his journal was removed to the White House on Truman's order.

**Richard Dolan**, in his detailed chapter on Forrestal's death included in his book "[UFOs and The National Security State - Part I](#)", notes that very few people were allowed to meet with him (his brother Henry had to ask many times before being allowed to visit) and that even his own religious confessors were inexplicably kept away by the Navy minders who supervised his care (Forrestal was a practicing Roman Catholic).

On the other hand, Truman, his successor at the Department of Defense, **Louis Johnson**, his old foe Stuart Symington and a few other high government officials called on him though he had not requested to see them. Truman was demonstrably worried about any undiscovered papers or recordings that might have been kept by his former cabinet member and in August of 1949, Louis Johnson sent him a confidential memo to reassure him that no voice recordings or any other documents concerning Truman's conversation with Forrestal remained.

Effectively, Forrestal had become a prisoner of the U.S. Navy. It appears that the government's concern was to prevent disclosures by the former cabinet member who ended his own life (or was made to) on May 22, 1949, in the night before his brother was to take him home following his apparent recovery.

Incidentally one of Air Force Secretary Stuart Symington's cousins is no other than **Fife Symington** who, while Governor of Arizona, on March 13<sup>th</sup> 1997 was one of the thousands of baffled witnesses to the spectacular "Phoenix Lights", described as the passage of a silent 2000 to 3000 feet wide delta-shaped matte black craft sporting a row of dazzling headlights, over the city.

After attempting to ridicule the sighting at a press conference by getting one of his staff to wear an "Alien grey" mask, Symington years later, when out of office apologized and readily acknowledged on camera at the Washington DC National Press Club that what he had seen was indeed "some form of an alien spacecraft".

The "ET factor" does seem to run across generations for some families.

There are of course many matters on which Forrestal must have had very privileged information that might have caused distress to Truman if he had spoken out, but an intriguing clue was provided by General **Arthur Exon**, the former commanding officer of the Wright Patterson Air Base (the site of Air Materiel Command) in 1990 when he stated that Stuart Symington had been a member of "Unholy 13" who controlled policy on UFO-related matters in the Government.

That group is almost certainly the "above top secret" [MJ-12 or Majestic Committee](#), reportedly appointed by Truman and Forrestal to manage the alien situation, on which Forrestal sat.

An exhaustive collection of the solid and confirmed reports of Alien sightings and encounters compiled since 1947 to this day would fill many books (which have already been written) and so we can only briefly mention a few of the most unquestionable records.

It is important to point out, as we noted earlier, that since the second half of World War, the U.S. had embarked not only on the top-secret, exorbitantly expensive Manhattan Project (the Oak Ridge Laboratory alone consumed one sixth of all the electrical power produced in the country during the War years) but also on an elaborate program to gain possession of all the advanced research and technology to be found in the Third Reich, through the JIOA (Joint Intelligence Objectives Agency).

Hundreds of "Nazi" scientists and engineers were identified and singled out for transfer to the USA in the belief that they could make an invaluable contribution to the American war machine as well as to its civilian economy.

No less than 86 aeronautical engineers and 127 rocket scientists, among them **von Braun**, and his boss **Dornberger**, were targeted by *Operation Lusty* (Luftwaffe Secret Technology) out of a total of some 1600 men. From 1945 on, most were brought to the USA after being secretly detained, often in violation of the Geneva convention since the Red Cross was kept in the dark about their locations.

Furthermore, in order to circumvent a U.S. legislation prohibiting asylum to those connected directly to the Nazi regime, those who could be held accountable for war crimes were provided with false records by the OSS.

The high priority operation known first as *Overcast* and [later as Paperclip](#) reflects the hypocrisy or at least the moral ambiguity of an all powerful military complex which blithely ignored national and international laws in order to achieve its goals, following in the footsteps of the Manhattan Project, coordinated by Dr. **Vannevar Bush**, the founder and head of the secretive *Office of Scientific Research and Development* ([OSRD](#)).

Bush is also believed to have set up and headed MJ-12, which according to classified correspondence of the time was kept at a higher level of secrecy than its now famous atom-bomb making predecessor.

The Lusty Operation acquired and stored at its Air Materiel Command Headquarters at Wright Field, Ohio (later Wright Patterson AFB) more than 16000 items, weighing 6200 tons, of blacklisted "foreign equipment" from the Axis powers, most of it related to aeronautics and ballistics. Since there was no independent U.S. Air Force as yet, the supervising authority was the Army's "Foreign technology Desk" at the Pentagon.

The late Colonel [Philip J Corso](#), a high-level military intelligence officer, has affirmed in his memoirs that said desk also received and held some "alien technology" recovered aboard the captured flying discs.

There is no escaping the conclusion that a hegemonic but paranoid United States, in the wake of the greatest war of the

20<sup>th</sup> century, quickly geared for a new confrontation, not only with the Communist powers in Russia and then in China, but also with a seemingly non-human off world agency, first believed to originate at or under the poles, which it defined as a secret but major threat.

President Truman, extensively briefed on the UFO sightings and encounters by his military Liaison officer Colonel **Robert Landry**, must, like all officials in the know, have been unnerved by the frequent visits of “unknown intelligent aircraft” to the most sensitive and restricted strategic facilities of the country, including the White Sands and Alamo Gordo installations.

Faced with a rising tide of reports about “alien spacecraft” in the media and an increasingly worried public, Truman admitted to the White House Press corps on April 4<sup>th</sup> 1950:

“I can assure you that flying saucers, given that they exists are not constructed by any power of on this Earth”.

The following years were to witness thousands of sightings and several spectacular UFO overflights of many of the world’s capitals, [particularly over Washington DC](#) as also over the Air Force bases and nuclear power plants of the USA and of the other great powers.



In 1952, shortly after the massive passages over the White House and the Pentagon by UFOs on January 19<sup>th</sup>, the President had General **Hoyt Sanford Vandenberg**, the Air Force Chief of Staff tell that it had been confirmed that they were neither Russian nor American and that the government did not know their identity or origin.

However Vandenberg, a former director of Central Intelligence, had been directly associated with the official handling of the Roswell incident in 1947 and is listed as a member of Majestic 12.

In 1948, he had partly dismissed, without giving his reasons but seemingly on grounds of national security, the “Estimate of the Situation” appended to his own USAF staff’s [Project Sign report](#) on UFOs, favoring an Extra-terrestrial origin. The report was subsequently burnt on his orders in 1950. The evidence of an attempt at a cover up appears overwhelming.

It is worth noting that the personal papers of the General are kept at the National Archives where they are classified (inaccessible to the public). He thus arguably knew more than he publicly declared in 1952 about the nature of the flying vehicles that had buzzed the federal capital.

Other superior officers were more outspoken as shown by General George Ramey, deputy chief of AF staff for operations, on July 29, 1952 when he gave a press conference in which, according to the San Francisco Examiner, he

stated: Jets have been placed on 24 hour nationwide alert against flying saucers with orders to shoot them down if they refuse to land.

According to reporter Robert Gardner, General **Benjamin Childlaw**, GOC, Air Defense Command in February 1953 told him significantly:

We take them seriously (flying saucers) when you consider we have lost many men and planes trying to intercept them.

In Europe and on the other side of the iron curtain, Soviet top military officers were making similar comments though those were usually censored or downplayed in the state media.

Rumors supported by credible “inside” sources, spread about President [Eisenhower meeting twice with “Nordic” looking alien visitors](#) on board their spacecraft at two Air Forces bases in 1954 but whether that happened or not, we cannot ignore Wernher von Braun’s revealing 1959 announcement:

“We find ourselves faced by powers which are far stronger than hitherto assumed, and whose base is at present unknown to us. More I cannot say at present. We are now engaged in entering into closer contact with these powers, and within six or nine months it may be possible to speak with more precision on the matter”.

(quoted in *Above Top Secret*, by Timothy Good, 1988)

Von Braun seems to have approached the UFO mystery with an open mind and a rather optimistic disposition; but such was not the mindset of the Generals and civilian officials who ran the Pentagon and the Intelligence Agencies.

They obviously saw potential enemies in the unknown visitors and called for mental and technical mobilization at the highest levels of government against what they perceived as a formidable threat.

Statements on record from top men in uniform such as **Nathan Twining**, **Benjamin Childlaw** and **Douglas MacArthur** attest to that.

The latter issued a stern warning to the graduating class of 1962, on May 12<sup>th</sup> at the West Point Academy, possibly letting out more than what his peers wished when he talked about,

“ultimate conflict between a united human race and the sinister forces of another planetary galaxy”.

Already then, perhaps from the time of the Mars invasion broadcast by Orson Welles in October 1938, the UFO-ET phenomenon had become part of popular culture through innumerable books, radio programs, films and television series.

The information has spread around ever more widely, though it is surrounded by an equally large amount of misinformation, generating a climate of general confusion.

In recent years, classified documents released by the governments of several countries, including the Defence Ministries of Britain, France, Brazil, Peru and Mexico, have once and for all provided hard evidence for the existence of Alien beings piloting very advanced flying craft and landing on earth.

One of the reports released by the MOD of the UK in July 2010 indicates that Prime Minister Winston Churchill had agreed with General Eisenhower to cover up close encounters between military Planes and UFOs during the War, in the interest of national security and social stability. Revealingly, Churchill was concerned that religion might be fatally harmed as a result of public disclosure of those incidents.

However, side by side with the technological and military developments connected with the official reaction to the UFO phenomenon, there was a less visible spiritual effect. General Dornberger occupied a high position at the Bell Aerospace Corporation, in which was associated with Arthur M Young, the visionary engineer and inventor who founded the Institute for the Study of Consciousness.

Young and researcher [Andrija Puharich](#) were both members of the Round Table Foundation, at Glen Cove, Maine, which acted as a “channel” for a series of messages reportedly sent by an assembly of Extra-terrestrial authorities designated as [the Council of Nine](#), through a visiting Indian medium, the respected Indian spiritual teacher and clairvoyant Maharshi **Nyayaratna DG Vinod** from Mumbai, known to many of the leading figures of India at the time of the Independence, including Mahatma Gandhi, Sri Aurobindo and Rabindranath Tagore and who had been invited to the USA by the University of Duke.

The Nine were said to have inspired Gene Roddenberry to create his immensely successful Star Trek television series.



Vinod achieved great fame in the world of ESP research as he lectured and collaborated with several universities and specialized institutes in the USA (such as Dr. Pfeiffer's parapsychological research center in Spring Valley, NY) and Europe. He met figures of the caliber of Jung, Aldous Huxley, Einstein and Millikan.

The Round Table Foundation was supported by the prestigious Stanford Research Institute (SRI), whose director was then Dr. [Harold Puthoff](#), a pioneer in para-normal and UFO-related studies.

A related organization was the Jason Institute which focused on defence-related matters and was thereby related to the CIA whose various, and generally infamous, programs to investigate and test the potential for mind warfare and related clandestine operations, such as [MK Ultra](#) and Artichoke, bear a relation to the observation and investigation of UFOs, as recognized by the well known researcher **H.P. Albarelli**, founding member of the *North American Truth and Accountability Commission on Human Experimentation* and author of *A Terrible Mistake: the Murder of Frank Olson and the CIA's Secret Cold War Experiments* (2010), though the exact nature of the link is often difficult to assess.

There seems to be a form of cooperation between some "Aliens" and those U.S. agencies unless the latter are simply trying to use the information they gather from those beings.

Similar hints can be gleaned from other governments at one time or another. For example, the President of the Russian Buddhist Republic of Kalmykia, **Kirsan Ilyumzhinov** declared in 2010 on a prime time show on Russian Television that he had been abducted in 1997 from his Moscow home by "Alien yellow-clad cosmonauts" aboard a spaceship and told that they were "not ready" to publicly interact with mankind.

This statement triggered an official letter from a deputy from the Duma, the Russian Parliament, to President **Dimitri Medvedev** seeking a clarification on the significance of this testimony and its implications for national security.

However no response from the Russian head of state seems to have been forthcoming so far and his silence may be another evidence of the deep quandary that many states find themselves in.

In 2009, the wife of Japanese then-Prime Minister Hatoyama reiterated to the Media that she had been "taken to Venus" on a UFO.

## Coded Messages

One of the most puzzling but spiritually and aesthetically pleasing phenomena generally regarded as a corollary of the presence of UFOs is the frequent appearance of the "[crop circles](#)" in various parts of the world, but more often in England.

The extraordinary complexity of those geometric patterns whose shapes and designs closely resemble the Indian yantras and mandalas denotes not only an unknown and very sophisticated technology - seemingly using microwave beams - to produce them, generally in the dead of the night and in a matter of seconds, with no visible agent being present (except for some rapidly moving lights which disappear as suddenly as they manifest) but also a deep familiarity with the sacred geometry of the ancient world and with advanced mathematics and bio-physical laws.

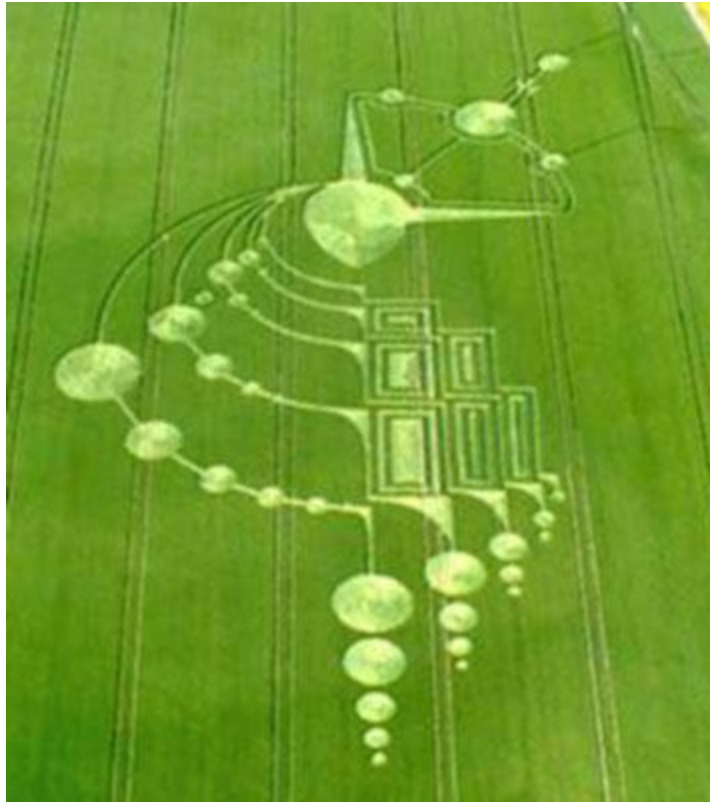

It has been demonstrated by various scholars in the subject that those “circles” sometimes contain elaborate scientific formulations and reveal new equations and physical laws.

Attempts by professional skeptics to “debunk” the mystery by getting pranksters to draw some of the relatively cruder patterns on fields with the help of ropes and other primitive tools, belong to the systematic policy of denying the “para-normal” reality altogether, dismissing evidence by means of flimsy pseudo-explanations.

They don’t change anything to the reality of the crop circle phenomenon, no matter what many people, unfamiliar with the facts, have been led to believe.

NASA photographs taken in outer space have been interpreted by some experts to show some gigantic artificial objects that appear to be the “massive spaceships” alluded to by astrophysicist **Stephen Hawking** in a recent TV documentary on cosmology and the flying cities and celestial lokas described in some ancient Indian texts.

Even more amazing are some genuine, unretouched or photoshopped pictures showing UFOs, sometimes of a very large size, as being almost invisible or transparent, as if they moved on the fringe of our physical universe or at least on the edge of electromagnetic perception. They would hence appear to belong to the other dimensions often described in ancient texts as also by contemporary “occultist” writers.

It is therefore much easier to understand why that facet of reality has generally been discounted or ignored by mainstream scientific research.

We will give the last word to eminent psychoanalyst **Carl Gustav Jung** who did considerable research on the subject of UFOs and who concluded:

“It remains an established fact, supported by numerous observations, that UFOs have not only been seen visually but have also been picked up on the radar screen and have left traces on the photographic plate.

It boils down to nothing less than this: that either psychic projections throw back a radar echo, or else the appearance of real objects affords an opportunity for mythological projections”.

([A Fresh Look at Flying Saucers](#), Time, August 4th, 1967)

Then, are Indian mythology and ancient history (Itihasa: “so it was”), among others that have come down from the remote past on most continents, records of an era when human beings acknowledged the presence of gods or “shining ones” hailing from various “heavens” and dimensions, and interacted with them on many levels?

If so, our modern “scientific worldview” is in need of drastic review and correction and the history of our origins could be very different from what we are taught in schools.

**Return to The Vimanas  
Return to The Saga of Flying Objects  
Return to German Disc Aircrafts - 1922-1945 and Beyond**

# **La Sociedad Thule**

por Carlos Sumario  
del Sitio Web [BolinfoDeCarlos](#)

## **Los Ovnis de Hitler**

**Los científicos de Hitler durante muchos años trabajaron en el diseño de extraños objetos voladores. Según informes secretos recientemente descubiertos, el III Reich poseía una tecnología tan altamente avanzada que le permitió construir platillos volantes de origen terrestre.**

**En el año 1919 von Sebotendorf, Klaus Haushofer y Dietrich Ekar fundaron la “Sociedad Tule”, una amalgama de sociedades secretas con ramificaciones por toda Alemania. Se sede central estaba en Munich y muchos miembros de esta sociedad se alzaron en clara oposición contra la breve República Socialista de Baviera.**

**Fundaron un partido político, y en el año 1921 nombraron portavoz político a Adolf Hitler, un joven conocido por su afición al ocultismo. El proyecto de Hitler de fundar un imperio milenarío, estaba inspirado en la doctrina de la Sociedad Tule.**

**Las ambiciones políticas de la Sociedad Tule generaron la formación de pequeños grupos independientes, uno de los cuales se denominó “[Sociedad Vril](#)”. A finales de 1919, un selecto grupo de miembros de las sociedades Tule y Vril se reunieron en una mansión en Berteschgarden.**

**En aquella ocasión la reunión estuvo presidida por el doctor Schumann, su especialidad es lo que hoy denominaríamos “Energías Alternativas”. Sin embargo, en el encuentro también estuvo la medium María Ostich, y una joven llamada Siegrund, que también actuó en algunos momentos como medium.**

**María, leyó unos textos que había recibido de los espíritus en idioma [sumerio](#), y otro cifrado en el código secreto de la [Orden de los Templarios](#), ambos textos fueron traducidos.**

**¿Eran mensajes de los dioses o [indicios de una civilización extraterrestre](#), o a caso planes para desarrollar una tecnología capaz de llegar a las estrellas?**

**A partir de entonces, los miembros de la Sociedad Vril se consagraron a la realización de lo que sería una de las ideas más insólitas que haya concebido la mente humana: la propulsión por levitación.**

**Tras la llegada al poder del Partido Nacional Socialista, las sociedades ocultistas volvieron a la clandestinidad; la Sociedad Tule creó en el seno de las SS una organización secreta denominada “[Schwarzesolenoid - Sol Negro](#)”. La Sociedad Vril**

continuó con sus investigaciones científicas, así a mediados de 1934 creó su primera nave experimental de forma circular, propulsada por energía anti-gravitatoria. Los responsables de su construcción fueron el Doctor Schumann y un ingeniero de Wochum, probablemente, Andreas Epp.

A partir de 1929, la joven Gertie Woch, dirigió la Sociedad Vril, encargándose de atraer inversores particulares amantes del riesgo. A finales de 1934, la Sociedad Vril había construido una nueva aeronave, la [RFZ-II](#), dotada de una “propulsión Vril” mejorada y por primera vez con un sistema de dirección por impulsión magnética.

Medía poco más de 5m. de diámetro, además tenía alguna de las características distintivas de los OVNIS: desaparición óptica del contorno y variación del color según el nivel de potencia, naranja, amarillo, verde, blanco, azul o violeta.

A pesar de su sofisticación técnica, las aeronaves circulares apenas llamaron la atención de los líderes políticos de la época, aún así, animado por Victor Schaurberger y los recientes logros de Vril, el departamento de investigación de las SS, empieza a construir su propia nave circular.

Basándose en el “Convertidor Tacométrico” del capitán Hans Koler y adoptando algunos componentes de Vril, desarrollaron su propio “motor Tule”. A finales de 1938 habían construido una nave circular de reducidas dimensiones, propulsada mediante hélices, la RFZ-IV, para estudiar el comportamiento en vuelo de aquellos prototipos.

En el año 1939, las SS ya habían construido la RFZ-V, la primera gran nave espacial, de 25 m de diámetro y rebautizada con un misterioso nombre:

[Haunebu-I](#).

El primer vuelo de la Haunebu-I se realizó entre fuertes medidas de seguridad en Agosto de 1939.

Hay documentos que demuestran que en 1941 los ingleses poseían información acerca del proyecto ultra-secreto de las SS. Comparado con el sencillo prototipo de Vril, el Haunebu, era de una gran complejidad, por otro lado, la forma del motor le permitía disponer de más espacio aprovechable.

Con el estallido de la II Guerra Mundial, la competencia en el mercado del armamento se intensificó y aparecieron formas alternativas de energía que pretendían emular a los sistemas tradicionales. Se adoptó una fórmula de compromiso referente a los platillos voladores experimentales como el RFZ-VII.

Mientras, otros OVNIS cruzaban el cielo, como el pequeño Vril RFZ-II, que había empezado a prestar sus servicios a finales de 1940 como nave de reconocimiento, o como el RFZ-VI y el Haunebu-II. En Julio de 1942, empezó a hablarse con insistencia del “Fliegengyroskop - Giroscopio Volador Schriber-Habermold”, conocido como la “Peonza Voladora”, una aeronave circular de ascensión vertical propulsada a reacción.

A finales del mes de Julio, empezaron a realizarse los primeros ensayos prácticos, el 12 de Abril de 1945 Richard Niet dijo a Hitler: “Hoy bajo mi dirección y en presencia de tres oficiales de la Luftwaffe, el V-7, ha sido probado sobre el Mar Báltico”.

Las prestaciones y características de esta nave eran: el V-7 era un helicóptero supersónico provisto de 12 motores auxiliares BMW, que en su primer vuelo de pruebas llegó a una altitud de 23.800 m. y que en su segunda elevación llegó a los 24.200 m, además en principio, el aparato también podía ser elevado por fuentes de energía no convencionales.

Pero volvamos a los responsables en primera instancia de cuanto estamos contando. Durante el invierno de 1942, una nueva nave circular cruzaba los cielos del campo de pruebas de Vril, [la Vril-I](#), de 11 m. de diámetro y con un solo tripulante, tenía las dimensiones típicas de un caza-bombardero, esa era su finalidad, su armamento: dos cañones MK-108 calibre 300 y dos ametralladoras MG-17.

Al tiempo que se desarrollaba el Vril-I, se intentaba restablecer los contactos “sobrenaturales” y ya existían planos para construir una nave de mayores dimensiones, el Vril-VII. A finales de 1942, el departamento de investigaciones de las SS empezó a trabajar en una versión mejorada del Haunebu, el Haunebu-II, de 31 m. de diámetro y 11 m. de altura.

El Haunebu-II, debía alcanzar una velocidad de 6.000 km/h dentro de la atmósfera terrestre y se creía capaz de viajar por el espacio exterior. Algunas versiones del Haunebu-II, mostraban su vocación claramente militar, como el protector anti-radiaciones.

Pero las SS tenían aún un proyecto más atrevido, habían diseñado una Haunebu gigante de 120 m. de diámetro y según ciertos informes ya existía una Haunebu-III de 71 m., construida poco antes de acabar la II Guerra Mundial.

El departamento de investigaciones de las SS había incluso proyectado la construcción de una gigantesca estación espacial, guardaba un gran parecido con los antiguos dirigibles y fue bautizada con el nombre de “[Andromeda Maschine - Máquina Andrómeda](#)”.

Sus 100 toneladas de peso no parecían constituir dificultad alguna para situar el aparato en órbita.

El 3 y 4 de Enero de 1944, Hitler y Himmler, supuestamente se reunieron con el Sociedad Vril, para abordar el “Proyecto Vril”, el lanzamiento de una gigantesca nave espacial a través del canal dimensional, un espacio inexplorado a la velocidad de la luz, hacia los confines del Universo.

### Thule y Vril

El año 1919 se fundó en Alemania la [Sociedad de Thule](#), su fundador fue Haushoffer. Muchos jefes alemanes se conocieron en ella. A este individuo se le debe la elección de la esvástica colocada detrás de una reluciente espada como símbolo máximo del nazismo.

El nombre de Thule fue elegido en recuerdo del legendario, y para ellos existente, reino de Thule, que es otro nombre para designar a la legendaria Atlantis. Pensaban que en el desierto de Gobi había existido una avanzada civilización, destruida por un gran catástrofe. Sus habitantes habían tenido que emigrar al norte de

## Europa y otros hacia el Cáucaso.

Estos habitantes eran la raza primigenia de la humanidad, o sea los primeros arios puros. Su ideal era retornar a los orígenes y realizar las correspondientes conquistas para renacer esta civilización, tronco inicial ario.

Sus creencias lo llevaron a tener un conocimiento y contacto con colonias hindúes y círculos tibetanos que tenían una visión muy próxima a sus principios.

El plan de Hitler fue el de fundar un imperio milenario y le fue inspirado por miembros de la sociedad Thule. Las ambiciones políticas de la sociedad generaron la formación de pequeños grupos independientes, uno de los cuales fue la sociedad "Hermanas de la Luz", llamada internamente Die Vril Chefin.

Los miembros de la Sociedad Vril se consagraron a la realización de una de las ideas que nunca jamás habría podido concebir la mente humana: La propulsión por levitación.

Después de la llegada al poder del Partido Nacional Socialista, las sociedades ocultistas pasaron a la clandestinidad. La Sociedad Thule creó en el interior de la "SS" una organización secreta llamada: [Sol Negro](#). Esta sociedad vio los resultados por la sociedad Vril y empezó la fabricación de su propia nave a finales de 1938 y habiendo combinado varias tecnologías.

En el año 1939 la sociedad Sol Negro ya había construido una nave circular la RFZ-5, la primera nave espacial de 26 m de diámetro y 9 m de altura con el nombre de Haunebu-I.

### El asesinato masónico del miembro de Thule Rudolf Hess

Entre los miembros de la sociedad Thule se encontraban, además de los paganos Heinrich Himmler y Alfred Rosenberg, también sacerdotes (como el confesor de Hitler, Bernhard Stempfle), monjes cistercienses (Guido von List) y miembros de la Orden del Temple refundada (los llamados "Herren von Schwarzem Stein"), además de nacionalistas, patriotas, antimarxistas y antijudíos.

El autor alemán Jan Udo Holey afirma en su libro "[Sociedades Secretas y su Poder en el Siglo XX](#)" que, "la Sociedad Thule o bien algún esqueje de ella continúa existiendo hoy".

Vamos a ocuparnos ahora del asesinato (no "suicidio") del miembro de Thule Rudolf Hess.

Para quien no sepa acerca de este y hasta ahora impune asesinato masónico, recordemos que Hess fue asesinado por ahorcamiento en la prisión de Spandau (Berlín) el 17 de Agosto de 1987 a manos de agentes del servicio secreto británico y por orden de la primera ministra Margaret Thatcher, quien a su vez cumplía órdenes de la masonería, a la que pertenece. Este crimen contó con el beneplácito, ocultación y colaboración del gobierno masón de Alemania.

"Oficialmente" Hess se suicidó colgándose con una cuerda al cuello, pero es bien sabido que Hess padecía una terrible artrosis que le había dejado los brazos casi inmóviles y en los que no tenía

además ninguna fuerza, lo cual le hubieran impedido por completo levantarlos para atar la cuerda...

¿Un anciano prácticamente inválido se suicidó así? Es como si un parapléjico saliera corriendo. Por otro lado, ¿por qué iba Hess a suicidarse tras 40 años de prisión, por qué no hizo como Goebbels, que se suicidó con cianuro en 1945?

### Los 20 principales miembros de la Sociedad Thule

Los miembros más importantes de esta sociedad son nombrados en la obra del propio Rudolf von Sebottendorff, "Bevor Hitler kam" ("Antes de que Hitler viniera"):

1. Freiherr Rudolf von Sebottendorff \*, maestro supremo de la Orden.
2. Guido von List, maestro de la Orden.
3. Jörg Lanz von Liebenfels, maestro de la Orden.
4. Adolf Hitler, Führer, canceller del Reich y Führer de Alemania.
5. Rudolf Hess, lugarteniente del Führer y SS-Obergruppenführer.
6. Hermann Göring, mariscal del Reich y SS-Obergruppenführer.
7. Heinrich Himmler, Reichsführer SS y ministro del Reich.
8. Alfred Rosenberg, ministro del Reich y NS-Reichsleiter.
9. Hans Frank, Dr. honoris causa, NS-Reichsleiter y gobernador general en Polonia.
10. Julius Streicher, SA-Obergruppenführer y Gauleiter de Franconia.
11. Karl Haushofer, Prof. Dr., Generalmajor retirado.
12. Gottfried Feder, Prof. Dr., secretario de Estado jubilado.
13. Dietrich Eckart, redactor jefe del "Völkischer Beobachter" e íntimo amigo de Hitler.
14. Bernhard Stempfle, sacerdote confesor de Hitler e íntimo.
15. Theo Morell, médico de cámara de Hitler.
16. Franz Gürtner, presidente de la policía de Munich.
17. Rudolf Steiner, fundador de la doctrina antroposófica.
18. [W. O. Schumann](#), Dr., científico y profesor en la Universidad Técnica de Munich.
19. Trebisch-Lincoln, ocultista y explorador del Himalaya.
20. Condesa Westrap.

\* Nota: "Freiherr" es un título nobiliario, no parte del nombre.

[Regresar a The Thule Society](#)

[Regresar a German Disc Aircrafts - 1922-1945 and Beyond](#)

- La Prodigiosa Tecnología del Tercer Reich -

# Los "Ovnis del Reich"

Nazis en La Luna

Diciembre 8, 2008  
del Sitio Web [ZisisWeblog](#)

El Tercer Reich fue para Alemania una época de progreso en todos los campos: Alemania poseía los autos más rápidos, los aviones más veloces y de mayor autonomía de vuelo, la primera televisión (durante los Juegos Olímpicos de 1936), las mejores películas de entretenimiento, la industria farmacéutica más pionera, etc.

Pronto volaron los primeros aviones a reacción (Me-262) y los primeros misiles de largo alcance (V2). Todo esto es conocido.

Mucho menos conocida es otra tecnología que, por razones obvias, los alemanes del Reich mantuvieron en secreto y sobre la que los aliados, una vez tuvieron noticia de ella, mantuvieron el más absoluto silencio.

Basándose en la filosofía ocultista del Tercer Reich ([Sociedades Thule y Vril](#)), científicos hitlerianos habrían conseguido avances científicos (especialmente aeronáuticos y astronáuticos) de una magnitud inimaginable.



El conocimiento de misteriosos aviones circulares alemanes propulsados por motores anti-gravitacionales con el nombre en clave de "Vril" y "Haunebu", que supuestamente fueron desarrollados no basándose en la técnica convencional, sino en una nueva técnica surgida de la filosofía ocultista NS, ha sido siempre negado por las fuerzas aliadas.

Muchos podrán pensar que es imposible que los alemanes en tan corto espacio de tiempo desarrollaran tan fabulosa técnica, pero olvidan que no se basaron en los principios científicos clásicos, si no, como ya hemos apuntado, en la filosofía ocultista de las sociedades germánicas como Thule y Vril.

Así por ejemplo, el científico alemán **Viktor Schauberger** era un convencido defensor de la "implosión en lugar de explosión". Rechazaba el motor de explosión, pues éste se basa en la destrucción (explosión), pero la Creación divina



es siempre constructiva.

Por lo tanto, una técnica basada en la destrucción es contraria a las leyes de *Dios* y puede denominarse como técnica satánica. En su lugar, proponía los motores de implosión. Éste es tan sólo un ejemplo de la filosofía de estos científicos. Gracias a la forma de pensar del Tercer Reich, los alemanes avanzaron en técnica en pocos años lo que los aliados no avanzarían en cien.



A mediados de los noventa dos documentales de televisión sobre los platillos nazis conmocionaron a la comunidad ufológica internacional. En ellos se vinculaba la existencia de prototipos discoidales diseñados en la Alemania de entreguerras y las tradiciones esotéricas que tanto influyeron en la gestación del III Reich. Personalmente he visionado un video titulado “OVNIs: El arma secreta de Hitler”, en que se trataban estas cuestiones.

Pero mucho antes, libros como “Geheime Wunderwaffen” (“Armas prodigiosas secretas”, partes 1, 2 y 3), de D. H. Haarmann o “Deutsche Flugscheiben und U-Boote überwachen die Weltmeere” (“Platillos y submarinos alemanes vigilan los mares del mundo.)

**O. Bergmann**, hablaban ya de los “OVNIs del Tercer Reich”.

## Proyecto Haunebu

Sobre la denominación “Haunebu” no hay acuerdo. Algunos afirman que se trata en realidad de la abreviatura de Hauneburg\*, lugar en que serían desarrollados. Este nombre sería abreviado como “Haunebu” por falta de espacio en las casillas de los formularios.

\* **NOTA:** Hauneburg era un pueblo situado en el Haunetal (el valle Haune), situado en el norte de la provincia alemana de Hessen. Como vemos, el lugar no es ficticio y probablemente fue allí donde se desarrollaron los platillos de la serie “[Haunebu](#)”.

Aquí mostramos algunas imágenes de los tres modelos de Haunebu.

La pregunta que todos nos hacemos es:

¿por qué los OVNIs que aparecen en las fotografías y el video que filmó [Adamski](#) se parecen TANTO al modelo [Haunebu II](#)?

## Proyecto Vril

El proyecto Vril estaba en manos de [la Sociedad Vril](#), el círculo de *damas* esotéricas. Era un diseño independiente del “Haunebu”.

Los desarrollos empezaron con [el Vril 1](#) y culminaron supuestamente en el Vril 7. El primero ensayo con el Vril 7 tuvo lugar al parecer sobre el mar Báltico en invierno de 1944.

Fue todo un éxito.

## El “Andromeda-Gerät”

El “[Andromeda-Gerät](#)” o “aparato Andrómeda” era una nave nodriza.

Desconocemos si llegó a construirse antes de terminar la Segunda Guerra Mundial, pero de no ser así se construyó en Neuschwabenland tras la guerra con los planos y diseños previos. Tenía forma de cigarro, y esto coincide con la descripción de muchos pilotos de vuelo que dicen haber visto OVNIs con esa forma y de unos 140 metros de longitud.

¿Por qué Alemania, si disponía de esta tecnología, no ganó la guerra? Una pregunta que se formulará todo el mundo.

Las razones que los autores del hitlerismo esotérico apuntan son varias:

1. El desarrollo de esa tecnología llegó demasiado tarde, más bien entre 1944 y 1945, y no se pudo llegar a emplear militarmente. Ciertamente disponían de esa tecnología, pero no se llegó a tiempo a la fabricación masiva.
2. Los OVNIs de Hitler ciertamente eran muchísimo más veloces que cualquier avión existente, pero esto no bastaba. Se mostraron, al menos en esa fecha, no aptos como aeronaves caza.
3. Por alguna razón, los alemanes del Reich vieron la guerra materialmente perdida y decidieron replegarse, esperar un momento futuro en que la victoria del Reich fuese tan segura como contundente.

Si efectivamente el Tercer Reich nunca fue completamente destruido y subsiste actualmente oculto, no podría hablarse en absoluto de que el Reich perdiera la guerra.

El propio Hitler había declarado:

“En esta guerra no habrá vencedores ni vencidos, tan sólo muertos y supervivientes”.

Alemania fue ocupada y lo sigue hoy, pero otra Alemania, la verdadera y legítima, existe fuera del territorio tradicionalmente alemán.

## ¿Qué fue de la prodigiosa tecnología hitleriana?

No puede descartarse que poco antes del fin de la guerra se llegase a fabricar una limitada serie de platillos Haunebu II. Ésta posibilidad es apoyada por las numerosas fotos de OVNIs tras 1945, que tienen un asombroso parecido con el modelo Haunebu II (por ejemplo los OVNIs del contactado Adamski).

Es importante dejar en claro una pregunta fundamental:

¿Consiguieron los aliados esta prodigiosa tecnología como parte del botín de guerra?

En absoluto. Sería una verdadera contradicción pensar que los alemanes fueran capaces de desarrollar semejante tecnología para luego dejarla caer en falsas manos. Los científicos alemanes responsables del desarrollo de esta tecnología y todos sus creaciones habían desaparecido a tiempo de Alemania para cuando la guerra “terminó”.

Así por ejemplo, el terreno de la firma Arado en Brandenburgo, supuestamente empleado por la Vril-Gesellschaft, fue completamente dinamitado y no quedó nada. Los alemanes dejaron a propósito señuelos para despistar y distraer a los aliados.

Estos señuelos eran flamantes proyectos aeronáuticos del Tercer Reich, así como científicos como **Werner von Braun** (gracias al cual los americanos lograrían realizar el programa Apolo y llegar a la Luna), pero estaban basados en la técnica convencional (motores de propulsión a reacción o de hélice, a lo sumo).

La técnica antigravitacional fue puesta a salvo con antelación.

Según algunos autores, *los OVNIs de Hitler* fueron escondidos en algún lugar de [la Antártica](#), razón por la cual se

pondría en marcha la [Operación Highjump](#). Aun hoy hay gente convencida de que los Alemanes aun poseen una base de OVNIs y que los llevaron allí desmontados en submarinos.

El autor **Hans Altmann**, por su parte, escribió “Eine Deutsche Legende”, una novela autobiográfica donde narra su contacto con los alemanes del Reich y describe sus bases en Suramérica.

Los avistamientos OVNIs que en la actualidad se producen se deben a la actividad de los platillos alemanes, pues los alemanes del Reich están vigilando el planeta. Estos platillos serían pilotados por pilotos del “último batallón”. Éste “último batallón” intervendrá en el momento preciso durante la próxima caída de la civilización occidental. Vendrán a salvar Europa cuando el cataclismo sea inevitable.

La civilización occidental habrá caído mucho antes de 50 años. La decadencia de Occidente es patente: manifestaciones de homosexuales, ateísmo y ausencia de valores, aborto, drogadicción, paro y crisis económica, conflictos sociales, confusión generalizada...

Pero esta caída de Occidente no será el Apocalipsis ni tampoco la destrucción de Europa, sino un Renacimiento sobre valores completamente distintos. Muchos famosos visionarios y videntes coinciden cuando hablan de una nueva guerra mundial y de “revoluciones y guerras civiles en casi todos los países de Europa”.

Los miembros del gobierno invisible (judeo-masonería), que controlan las naciones más poderosas del mundo, no pueden hacer nada contra las fuerzas del mundo interior. Tienen miedo del “último batallón”, de los OVNIs de Hitler.

Por eso guardan silencio sobre su existencia y desvían la atención difundiendo que se trata de “extraterrestres”.

## Las bases lunar y marciana del Reich

Además de **Miguel Serrano**, han sido otros autores los que sostienen que los alemanes del Reich hace muchos años (unos sesenta años) que poseen una base en la Luna (si no un auténtico país). Disponiendo de semejantes astronaves, no es ningún problema para ellos alcanzar [la Luna](#) o [Marte](#).

Los OVNIs del Reich no tienen que preocuparse de llevar miles de toneladas en combustible líquido, ni del costo, como los programas espaciales de la NASA o la ESA.

Durante la [misión Apolo 11](#) a la Luna, los tripulantes del Apolo 11 mantuvieron una conversación con el centro de control en Houston, casualmente captada por unos radioaficionados que escuchaban un “canal reservado”, que revela que tuvieron un encuentro con aeronaves,

“muy superiores en tamaño y tecnología a las nuestras”.

Toda la Luna estaría en manos de los alemanes del Reich, razón por la cual los norteamericanos no han vuelto a ella: tienen “Hausverbot”, es decir, los alemanes del Reich les han prohibido poner un pie en la Luna.

Es por ello que ahora la **NASA** dice con cierto tono de desprecio que,  
“la Luna ya no constituye un objetivo interesante para la Agencia Espacial”.

Lo cierto es que después de 1972 (el primer alunizaje fue el 20 de Julio de 1969), no ha habido más misiones a la Luna.



La NASA declara que se interesa más por Marte, donde según autores como [Jan Udo Holey](#) o [Hans Altmann](#) también los alemanes están establecidos en construcciones subterráneas desde hace decenios.

Los repetidos fracasos de la NASA en Marte tendrían su explicación en la actuación de los alemanes del Reich.

## La base lunar Alpha

La base lunar del Tercer Reich tendría el nombre de “Alpha” y se habría empezado a construir en 1942.

**Vladimir Terziski**, presidente de la “American Academy of Dissident Sciences” escribió en 1992 un artículo (en inglés) titulado “[HALF A CENTURY OF THE GERMAN MOON BASE](#) (1942 – 1992)”.

En ese artículo se habla también de la estrecha cooperación entre alemanes y japoneses. Y así fue y lo sigue siendo hoy, pues el Reich de Adolf Hitler hizo partícipe en sus ambiciosos planes de futuro al Imperio Japonés, aliado fiel del Tercer Reich. Lo mejor de Occidente y Oriente se habría unido en esta gran empresa de conquista del espacio.

No fueron los norteamericanos los primeros en pisar la Luna ni los rusos los primeros en poner un hombre en órbita, sino los alemanes del Reich, junto a sus camaradas japoneses.

## El Apolo 11 y su encuentro con “extraterrestres” en la Luna

El ufólogo **Timothy Good**, en su libro [Beyond Top Secret](#), informa de que los astronautas vieron “extraterrestres” en la Luna.

La evidencia reside en una conversación secreta entre el control de la misión y los astronautas del Apolo 11, Armstrong y Aldrin, que fue registrada por unos radioaficionados que pudieron captar un “canal reservado” para estos mensajes, tal como informó mucho después un ex-empleado de la NASA, **Otto Binder**.

La transcripción de la conversación es la siguiente:

- ¡Oh, Dios, nadie lo va a creer!

- Houston: ¿Qué es, diablos, qué es? ¡Es lo único que quiero saber!

- Apolo 11: Estas pequeñas cosas son gigantescas, son enormes... No, no, lo de ahora era una desfiguración óptica del terreno. ¡Oh, Dios, nadie lo va a creer!

- Houston: ¿Qué... qué... qué diablos está ocurriendo allí? ¿Qué os pasa, chicos?

- Apolo 11: Están allí, bajo la superficie.

- Houston: ¿Qué hay allí? [Interferencias, ruido] Control llamando a Apolo 11.

- Apolo 11: Roger, estamos aquí los tres, pero vimos unos visitantes. Estuvieron aquí un rato, observando los instrumentos.
- Houston: Orden de control: ¡Repetid el último informe!
- Apolo 11: Digo que había otras astronaves. Están alineadas en el otro borde del cráter.
- Houston: ¡Repetid, repetid!
- Apolo 11: Dejados sondear esta órbita y a casa... En 625 al 5... Relé automático conectado... Mis manos tiemblan tan fuerte que no puedo hacer nada. ¿Filmar? Cielos, sí, esas malditas cámaras han filmado.
- Houston: ¿Habéis captado algo?
- Apolo 11: No tenía ninguna película a mano [ruidos], tres disparos de los platillos o de lo que fuera pueden haber estropeado la película.
- Houston: Control de mando, aquí, control de mando. ¿Estáis ya en camino? ¿Qué hay con ese jaleo de los ovnis? Cambio.
- Apolo 11: Han aterrizado ahí. Están en la Luna y nos observan.
- Houston: Los espejos, los espejos. ¿Los habéis colocado?
- Apolo 11: Sí los espejos están en su sitio. Pero quien haya fabricado semejantes astronaves puede seguramente venir y quitarlos mañana mismo del suelo. Cambio y fuera.

También cierto profesor, que desea permanecer en el anonimato, mantuvo una conversación con Neil Armstrong durante un simposio:

- Profesor: ¿Qué ocurrió realmente con Apolo 11?
- Armstrong: Fue increíble; claro, pero el hecho es que nos advirtieron que debíamos irnos. Nunca se nos dijo nada sobre una estación lunar...
- Profesor: ¿Qué quiere decir con eso de que “nos advirtieron que debíamos irnos?”.
- Armstrong: No puedo entrar en detalles, excepto para decir que sus naves eran muy superiores a las nuestras en tamaño y tecnología.
- Profesor: ¡Pero la NASA envió otras misiones después de Apolo 11!
- Armstrong: Naturalmente, la NASA estaba comprometida en esa época y no podía arriesgarse a desatar el pánico en la Tierra, pero sí, fue algo rápido y de ida y vuelta.

El ufólogo Timothy Good, en su libro *Beyond Top Secret*, informa de que los astronautas vieron “extraterrestres” en la Luna. La evidencia reside en una conversación secreta entre el control de la misión y los astronautas del Apolo 11 Armstrong y Aldrin, que fue registrada por los soviéticos.

El Dr. Vladimir Azhazha, físico y profesor de matemáticas ruso, dijo que el encuentro ocurrió poco después de que alunizara el módulo lunar, pero que el público nunca pudo escuchar el informe de los astronautas porque la NASA lo prohibió.

Maurice Chatelain, un especialista en comunicaciones de la NASA, comentó que, “el encuentro con OVNIS era perfectamente conocido en la NASA” y que “todas las misiones Apolo habían sido seguidas por OVNIS”.

Esto sugiere que la NASA no está dispuesta a admitir ante el mundo que sus astronautas habían sido vigilados de cerca por OVNIS, y menos todavía por OVNIS del Tercer Reich, y según ciertos autores escenificaron las fotografías en la Tierra para que el público no se asustase con lo que sucedía realmente en el espacio.

En un documental de TV que analizaba la dudas en torno al primer alunizaje, se mencionaba que esta escenificación tuvo lugar en algún estudio de cine de Londres y que se puso al frente de la misma al director Stanley Kubrick, razón

por la cual Stanley vivió obsesionado con el temor de ser asesinado por la CIA por todo cuanto sabía...

Según el Dr. **Vladimir Azhazha**, presidente del Centro de OVNIS de Moscú:

“Neil Armstrong transmitió al Centro de Control un mensaje de que dos objetos grandes y misteriosos los observaban cuando alunizaron. Pero este mensaje nunca fue oído por el público, ya que la NASA lo censuró”.

El Dr. Aleksandr Kasantsev afirma que Aldrin hizo un grabación en color de los OVNIS desde el interior del módulo.

Una de las más extrañas preguntas sobre la Luna es *por qué la NASA no ha enviado más astronautas desde las misiones Apolo* y por qué no tiene intención de hacerlo en el futuro. Ellos aducen que es ahora Marte el astro que les interesa, pero si damos crédito a las informaciones sobre bases permanentes de los Reichsdeutschen en la Luna, tendremos de inmediato la respuesta...

Las actuales misiones de la NASA a Marte tienen como objeto tantear *las fuerzas alemanas establecidas allí*.

Y hay que destacar que son muy sospechosos los repetidos fracasos y la inexplicable “mala suerte” de la **NASA** en estas misiones marcianas...



## Avistamientos por astronautas

Los estudiosos del fenómeno OVNI aseguran que los astronautas que “hablaron demasiado” sobre lo que descubrieron en la Luna pronto fueron dados de baja y tuvieron que abandonar el servicio activo, como en el caso de **Gordon Cooper**, que después de haber integrado el equipo del proyecto Mercury y tripulado éste en 1963 y el Géminis 5 en 1968, no fue enviado con destino a la Luna en el Apolo...

Poco después se declaró abierto partidario de la existencia de OVNIS.

La NASA no ha revelado la existencia de los OVNIs del Reich ni siquiera a sus propios astronautas, que nunca fueron prevenidos y tuvieron que enfrentarse súbitamente al shock de encontrarse de golpe con esas astronaves durante sus misiones en el espacio, poniendo sus vidas en peligro, pues un astronauta con pánico comete errores.

Muy posiblemente, la NASA ha hecho creer a sus propios astronautas que esas astronaves pertenecen a “civilizaciones extraterrestres”, ni los propios astronautas conocen la verdad sobre su origen terrestre. Es por ello que a menudo los astronautas hablan de “[vida extraterrestre](#)”, porque es lo que la **NASA** ha querido que crean, o porque colaboran conscientemente con la campaña de desinformación.

Pero es muy probable que los OVNIs se hayan acercado tanto a los trasbordadores y a astronautas que éstos hayan visto esvásticas y cruces balcánicas en los OVNIs. Hasta la fecha, ningún astronauta ha declarado esto ni ha hablado de “OVNIs del Reich”.

Si lo hiciera, sabe que *sería asesinado*.

Además, los astronautas son adoctrinados en la idea de que la existencia de los OVNIS y todo lo que ellos han visto durante sus misiones debe permanecer bajo secreto por bien de la seguridad nacional y para evitar el pánico en la Tierra.

## Los OVNIS del Proyecto Mercury VII

El 24 de Mayo de 1962, el astronauta **Scott Carpenter** logra fotografiar a un objeto en forma de disco, mientras se encontraba en el espacio a bordo del Aurora VII.

Cuando Carpenter se encontraba a 275.000 metros de altura, vio acercarse “algo” a la cápsula, inmediatamente comunicó a Houston:

“¡Es metálico! y refleja intensamente la luz solar”.

El objeto siguió desplazándose en sentido contrario a la marcha de la Aurora 7, hasta perderse de vista.

Scout Carpenter, mientras orbitaba la Tierra en Mayo de 1962, a la altura de Australia, comunico a la base:

“Estoy observando unas partículas luminosas que vienen a mi encuentro, ¡son muy rápidas! Y parecen tener una luz mas brillante que las estrellas... ¡Entonces ellos existen...! ¡Son ellos...!”

Scott Carpenter, a bordo de la cápsula Aurora 7, vio y fotografió a varios objetos de gran tamaño y luminosidad que siguieron al vehículo norteamericano durante su corto periplo espacial. La NASA dio una absurda explicación a las fotografías, diciendo que eran “cristales de hielo adheridos a las ventanillas”.

En su tercera vuelta a la Tierra, Carpenter vio otro objeto y comunicó a Houston:

“Está claro que aquello no orbita la Tierra... Viene de otra parte”.

Carpenter reconoció haber sentido miedo, también dijo:

“Era cilíndrico, enorme... y se movía a gran velocidad”. *[Nota: ¿Cilíndrico y enorme? ¡El Andromeda-Gerät!]*.

El objeto se inmovilizó junto a la Aurora 7 y siguió su misma trayectoria. Entonces, de aquel cilindro salieron 3 objetos en forma de disco, los cuales se alejaron. Al instante que la nodriza desapareció hacia las estrellas”.

Algunas declaraciones de gente de la NASA.

La NASA siempre ha dicho que lo encontrado en la Luna por las expediciones no tiene ningún secreto, sin embargo, el doctor Farduk Elbaz, uno de los más prominentes científicos de la NASA, admitió:

“No todo lo descubierto se ha anunciado”.

Añadió también que se utilizó un “código secreto” en las conversaciones entre los astronautas y la base de control de la Tierra. ¿Es que había algo que ocultar?

El científico Maurice Chatelain, que estuvo a cargo del equipo de comunicaciones del Apolo, declaro que:

“Todas las naves Apolo y Géminis fueron seguidas por vehículos espaciales que no pertenecen a este planeta. Siempre que esto ocurre los astronautas informan al centro de control y desde allí se les ordena silencio absoluto”.

Añadió además que:

“Los astronautas del Apolo XI no solo escucharon ruidos extraños en la radio cuando se acercaban a la Luna, sino que se encontraron con un comité de bienvenida: dos ovnis que contemplaban el alunizaje”.

Más que “contemplaban” habría que decir “vigilaban”...

**Fred Bell**, otro científico que trabajó para la NASA dice:

“Los astronautas han guardado silencio sobre sus encuentros con ovnis porque están entrenados para creer que es una cuestión de seguridad nacional”.

Además el doctor Bell aseguro haber visto fotografías de OVNIS tomadas por los astronautas. Aseguró que [el Proyecto Apolo](#) fue interrumpido abruptamente debido a que se habían encontrado “demasiadas cosas allá afuera”, tomando seguramente muy en serio la prohibición del Reich de volver allí.

El ex-astronauta **John Glenn**, posteriormente senador de los EE.UU., hizo importantes declaraciones para un programa radiofónico, sin saber que estaba siendo grabado:

“Sabemos perfectamente lo que vimos allí afuera, pero no podemos contar nada”.

Además agregó lo siguiente:

“Nunca conoceremos la verdadera respuesta... Aún así, vimos cosas allá afuera, cosas extrañas...”

**Regresar a La Luna**  
**Regresar a German Disc Aircrafts - 1922-1945 and**  
**Beyond**

**Regresar a Germany's ET Contacts? - Its Legacy On The Twentieth Century And After...**

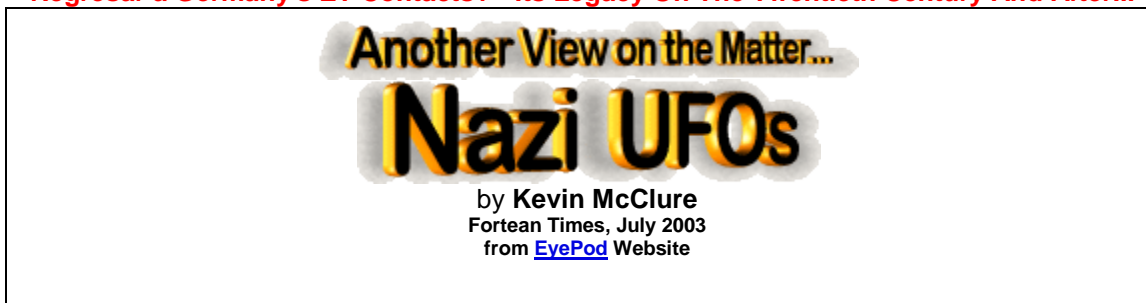

**Kevin McClure** wrote The Fortean Times Book of the Millennium (1996), predicting that nothing of interest would happen. His initial investigation of the Nazi UFO mythos appeared in Fortean Studies 7.

He edited Abduction Watch and has written for FT, Magonia, Fate and others. He is currently collecting evidence of the manipulative presence of neo-nazi and racist influences in the field. In real life, he works for the government.

It's much easier to dismiss an absurd claim that is fresh and new than one which has been around for a while and taken root.

Dislodging established and much-repeated nonsense is much more difficult, but that doesn't mean we shouldn't try. And in cases where such nonsense tends to exaggerate or glorify the activities of the Nazis during World War II, I think we should try particularly hard. In that spirit of endeavour, let's see what we can do about the very untrue story of **Viktor Schauberger** – builder of flying saucers.

The detailed and ever-growing fiction of the *Nazi UFO mythos* tells us that the Nazis were so technically, creatively and scientifically brilliant that, had the war only lasted a few months longer, they would have won it by using their amazing flying saucers, which were so very nearly ready for combat when the Allied forces entered Czechoslovakia and Southern Germany.

There are two hurdles the mythos has always fought to overcome.

Firstly, that there is no historical record that the characters said to have been involved in saucer development – figures like Schriever, Belluzzo, Habermohl, Miethe and Kleinever – had anything to do with the development of 'flying discs'. Only Guisepppe Belluzzo has any verifiable scientific background at all; Schriever was a delivery driver, and it is unclear whether Habermohl and Miethe even so much as existed as identifiable individuals.

Secondly, there is no historical evidence – physical or photographic – of the supposed flying discs. We are repeatedly told of craft of immense power, and sometimes immense size, defying all scientific parameters known before or since. Yet not so much as a bolt or a tachyon drive remains to verify their existence.

There are just the oft-reproduced, fuzzy post-war photos taken by those who wished to convince us of saucer reality, but who usually succeeded only in demonstrating the unexplored potential of domestic containers and the art of close-up photography.

The mythos argument is that rather than being extraterrestrial in origin, the discs photographed between 1947 and 1955 were actually developed from captured Nazi blueprints, by captured Nazi scientists.



Relocated to America, they chose to have their miracle craft chug unimpressively around the dusty back roads of the USA, sometimes landing, sometimes crashing, and sometimes – particularly the very small discs – utilizing conveniently-placed string to hang from trees, swinging gently and photogenically in the wind.

Not one claim of flying Nazi discs pre-dates 1949 and the increased US media interest in reports of flying saucers.

## Enter Schauberger

Once upon a time, in Austria, there was a forester called **Viktor Schauberger**.



He lived from 1885 to 1958, and in his long life he devised and worked on a variety of inventions. He had a keen and original interest in the motion and motive potential of water, and the most notable of his achievements were in the design and development of log flotation methods and flumes in the 1920s.

Thereafter, he seems to have tried to develop his ideas towards turbines and cheap natural power and energy. There is little evidence that any of these later ideas ever reached fruition, and although his son and grandson have continued with some more theoretical aspects of his work, it seems that no repeatable demonstration of Schauberger's supposed flight technology has ever taken place.

For those who want to further the cause of secret Nazi science, or to maintain the flying saucer mystery, or both, Viktor Schauberger ([image left](#)) has been a prayer answered.

Not because he actually built flying discs for the Nazis, but because some round, bulbous inventions he probably worked on were photographed and, with a bit of airbrushing to add Luftwaffe insignia, they looked rather like the round, bulbous inventions that figured in 1950s ufology.

That he left no physical or technical evidence of his supposed disc experiments, was at times somewhat confused about the facts (there is evidence that he spent some time in a psychiatric hospital), and kept a diary in a shorthand that was difficult even for his family to comprehend, could only help.

He even had a long, impressive beard to suggest that he was a misunderstood genius. History was ripe for rewriting – and not just the once.

The 'Nazi UFO' mythos has itself had three distinct phases of life, with long fallow periods between. The first was in the early 1950s, when a few individuals, none of them connected with any post-war rocket or aviation programme in Russia, the USA or anywhere else, claimed to be at least partly responsible for the saucer sightings of the period. Schauberger – still alive at the time – didn't get a mention at that stage, and made no claim of his own.

Then, around 1975, Canadian **Ernst Zundel** ([image right](#)), also known as Christof Friedrich and notorious for his pro-active and well-publicized [skepticism about the reality of the Holocaust](#), published (as *Mattern Friedrich*) the book *UFO – Nazi Secret Weapon?* Amid questions like "*Is Hitler Still Alive?*" and "*Did the Nazis have the Atom Bomb?*" he set out a range of wild speculations about lost Nazi technology and, for the first time to my knowledge, introduced a number of the key elements concerning Schauberger's supposed involvement.



Zundel writes:

"Schauberger did experiments early in 1940-41 in Vienna and his 10 foot (3m) diameter models were so successful that on the very first tests they took off vertically at such surprising speeds that one model shot through the 24-foot (7.3m) high hangar ceiling.

After this 'success', Schauberger's experiments received 'Vordringlichkeitsstufe' – high priority – and he was given funds and facilities as well as help. His aides included Czech engineers who worked at the concentration camp at Mauthausen on some parts of the Schauberger flying saucers. It is largely through these people that the story leaked out."

Zundel also provided an account of Schauberger's later history and death. Although Schauberger actually died at home in 1958, Zundel's version has it that:

"Viktor Schauberger lived for some years in the United States after the war where he was reported to be working on UFO projects. His articles were greatly discussed and then one day in Chicago he just vanished. His battered body was found and as to who killed Schauberger or why has never been discovered. One version has it that gangsters tried to beat his revolutionizing secrets out of him and accidentally killed him."

Zundel published the first drawings of what he referred to as the 'electro-magnetically-powered Flying Hats'.

In the next year, 1976, a biography of sorts appeared (*Living Water*, Gateway Books, 1997), written by Olof Alexandersson, a Swedish 'electrical engineer and archive conservationist'.

While admitting that "the information for the basis of this book is fragile", he managed, from unlisted sources, to add substantially to the myths:

"After a while Schauberger received his call-up. It was now 1943, and even older men were being drafted. He was eventually appointed the commandant of a parachute company in Italy, but after a short stay, orders came from Himmler that he should present himself at the SS college at Vienna-Rosenhugel. When he arrived, he was taken to the concentration camp at Mauthausen, where he was to contact the SS standartenführer Zeireis, who told him he had a personal greeting from Himmler.

'We have considered your scientific research and think there is something in it. You can now either choose to take charge of a scientific team of technicians and physicists from among the prisoners, to develop machines utilizing the energy you have discovered, or you will be hanged.'

Schauberger understandably chose the first option (insisting that his helpers must no longer be regarded as prisoners) and so an intensive period of study began. After the SS college, where the research was taking place, was bombed, Schauberger and his team were transferred to Leonstein, near Linz. The project they initiated there was a 'flying saucer' powered by a 'trout turbine'.

The results of the research were surprising: it was both a success and a failure. Schauberger later explained this briefly in a letter to the West German defense minister Strauss on 28 February 1956:

"The first 'flying saucer' rose unexpectedly, at the first attempt, to the ceiling, and then was wrecked."

Alexandersson offered slightly different pictures of the 'flying hats', probably just removing the Luftwaffe insignia Zundel had added, and reproduced drawings of other absurd imaginary wartime UFOs copied directly from Zundel.

Since then, architect Callum Coats has published a series of books reflecting a persistent interest in Schauberger's theories about water and implosion. In 1996 (*Living Energies*, Gateway, 2001), he published what appear to be actual photos of the 'flying hats', as well as reprinting earlier drawings, telling us that:

"Despite its compact size, this machine generated such a powerful levitational force that when it was first switched on (without Viktor Schauberger's permission and in his absence!), it sheared the six quarter-inch [6mm] diameter high-tensile steel anchor bolts and shot upwards to smash against the roof of the hangar."

Coats also quotes one 'A Khammas', writing in the undated Issue 93 of *Implosion* magazine:

"There are many rumours about what Schauberger was actually doing during this period, most of which suggest he was in charge of developing 'flying discs' under contract to the army. It later became known that the 'flying disc' launched in Prague on the 19 February 1945, which rose to an altitude of 15,000 meters [50,000ft] in three minutes and attained a forward speed of 2,200 kph [1,370 mph], was a development of the prototype he built at Mauthausen concentration camp. Schauberger wrote, 'I only first heard of this event after the war through one of the technicians who had worked with me'.

In a letter to a friend, dated the 2 August 1956, Schauberger commented, 'The machine was supposed to have been destroyed just before the end of the war on Keitel's orders.'"

The tale is a fantasy taken from **Rudolf Lusar's** *German Secret Weapons of the Second World War* (1957).

Perhaps it is significant that while we are told that Schauberger twice effectively rewrote the book on aviation technology, we are also told that he was both absent from the demonstrations, and unaware that they had taken place.



Viktor Schauberger shown holding his implosion device, which is claimed to be the basis for some Nazi Antigravity research.

The most recent phase of belief in the *Nazi UFO mythos* began in the last six years. **Susan Michaels**, in *Sightings: UFOs* (Fireside, 1997), reproduces a range of palpable fictions from unreliable sources, and introduces some freshly-minted nonsense.

Possibly becoming confused by inconsistent, fictional accounts of a meeting with Hitler in 1933, she says: "Also in 1939, German physicist Victor Schauberger developed a design for a flying saucer using energy he claimed could be harnessed from the tonal vibrations, or 'harmonics', of the cosmos. As far-fetched as this theory seems, Schauberger's research attracted the attention of Adolf Hitler, who offered to provide funds to build Schauberger's own anti-gravity saucer. But Schauberger, who was a deeply committed pacifist, turned Hitler down."

The following year, UK aviation writer and photographer Bill Rose wrote an article ("UFO sightings – Why you can blame Adolf Hitler") in the popular science magazine *Focus* (October 1998).

After, apparently, four years of research, he concluded that:

"The father of the German disc programme was Rudolph Schriever, a Luftwaffe aeronautical engineer assigned to Heinkel in 1940... a full-sized piloted version, the V2, first flew in 1943 with Schriever at the controls. Thirty feet [9m] in diameter, the V2 had a fixed central cabin around which a ring with adjustable vanes rotated to provide thrust in both the horizontal and vertical planes..."

Early in 1944, Schriever's top-secret programme was moved to Czechoslovakia... Schriever was joined by a number of leading aeronautical engineers... Another addition was the Austrian scientist Viktor Schauberger, who just before his death in 1958, claimed to have worked on a highly classified US disc programme in Texas."

Rose seems to be the first to have suggested that Schauberger actually worked together with the four other 'engineers' who, according to the mythos, built flying saucers, but even Rose's remarkable 'sources' pale in comparison to those apparently available to Gary Hyland, author of *Blue Fires* (Headline, 2001), who says of Schauberger:

"The first test-flight of the machine was reportedly amazingly successful (it apparently shot through the roof of the laboratory and had to be recovered some distance away)... [Schauberger] developed his ideas further, to the point where a full-sized, though unmanned flying disc prototype that used his new engine apparently flew under radio control..."

At the end of the war, the American forces got to Leonstein ahead of the Russians and found Schauberger and his team of experts.

After letting the members of his team leave after a thorough interrogation, the Americans held Schauberger in protective custody for six months; it would seem that they knew exactly what he had been up to and wanted to prevent other nations, as well as renegade Nazis, from continuing to use his services".

## The Cook Report

Exceeding even the rich imaginations of **Michaels, Rose** and **Hyland** is the much-publicized book [The Hunt for Zero Point](#) (Century, 2001) by **Nick Cook**, a notable freelance aviation journalist who has written for the very respectable [Jane's Defence Weekly](#).

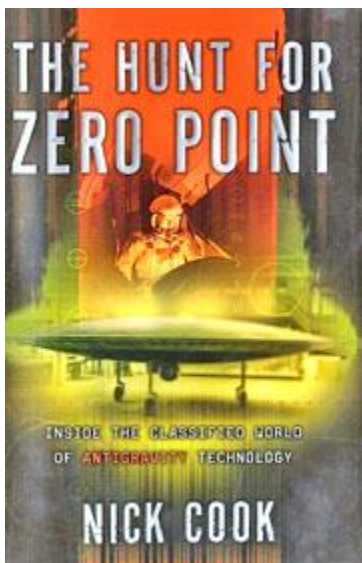

In the course of an investigation lasting, we are told, some 10 years, he appears to have been comprehensively misinformed by a whole series of individuals; or perhaps by individuals acting on behalf of a group with a specific agenda.

It seems that for all the informants he gathered along the way, none of them ever warned Cook that people with an investment in making the Nazi regime (and the SS in particular) look good are quite happy to use deception to do so.

Without going through Cook's oddly directionless book in any detail, it's worth noting that his primary source about Schauberger was a Polish gentleman named Igor Witkowski. Witkowski, apparently, volunteered to drive Cook around, showing him sites where Schauberger had worked for the Nazis, constructing and testing 'The Bell', an experimental device with two cylinders spinning in opposite directions.

Cook was told that this glowed blue and destroyed plants, birds, animals, and sometimes humans. Internet searches for [Witkowski](#) bring him up in conjunction with the loopy,

'1930s-crashed-saucer-back-engineered-by-the-SS' end of Polish ufology, and he has self-published six or more separate items with titles like *Hitler's Supersecret Weapon*.

Witkowski told Cook that his extraordinary information came from an unnamable source, which Cook seems to have accepted without question. It seems that a "Polish government official" phoned [Witkowski](#), inviting him to view documents and take notes about the development and concealment of extraordinary Nazi technology as given in a record of "the activities of a special unit of the Soviet secret intelligence service."

[Witkowski's](#) evidence, together with a visit to [Schauberger's](#) grandson, leads Cook to reproduce the material about imprisonment by the US after the war, and the apartment being blown up by the Russians, together with various unlikely claims about [Schauberger](#) being offered massive sums of money by (right-wing) Americans in the years before he died.

Cook also informs us that Schauberger's designs had been stolen by Heinkel in the early part of the war; that he had worked on secret projects for the Nazis from 1941-45, sometimes using slave labour; that he had created, specifically for the SS, disc-shaped machines with engines so revolutionary that even Cook, an aviation journalist, fails to explain how they worked.

One of the problems faced by the *Nazi ufologists* is to explain the complete absence of palpable evidence. **Cook** chooses to adopt SS General **Hans Kammler** ([image right](#)) for this purpose. [Kammler](#) used concentration camp labour to build the Atlantic Wall, contributed to the construction of the Auschwitz gas chambers, and was in charge of the V2 missile programme, which again ruthlessly exploited slave labour.



He is also, it seems, the person who spirited away all traces of Schauberger's astonishing technical achievements, allegedly to his own advantage by way of trade with the approaching Allies.

However, the earliest version I have found of this story dates from 1989, put about by *Nevada Aerial Research*, who have done much to publicize the supposed *wonders of Nazi technology* (and they later came up with the most unpleasant of the tales of dominant and brutal alien beings living below the US air base at [Dulce](#)). I do not believe that their account of Kammler had any existence prior to 1989, or that it is true.

There is no period of history more thoroughly examined than 1939-1945, and no subject more closely examined than the Nazis, and more particularly, the SS. Had there been any reality in the claims for the construction and testing (or more) of high-speed flying disc technology by the Third Reich during that period, then we would have every reason to expect that it would have been discovered, reported, and analyzed by writers and researchers far more competent than those referred to above. Yet it never has been.

Nonetheless, there is a recurrent and developing counter-cultural argument that insists these extraordinary events actually took place. It is a theory that has sold millions of books and videos, and it continues to fuel a belief that, given just a few more months, the true genius of the Nazis, the fanaticism of the SS, and the inspiration of the Führer would have won through, and the Allies – no, not just the Soviet Union, but all the Allies – would have been defeated.



While I'm happy to be challenged by solid evidence, I've found no reason to believe that **Viktor Schauberger** (left) knew anything of this. I think he died before it was made up. He never built a flying disc, let alone one that flew using some unknown and unprecedented method of propulsion.

He wasn't sought out by Hitler or the SS, didn't choose slave workers from Mauthausen to assist him, and wasn't held by the Americans after the war because of his technical knowledge and achievements. If the Russians burned his flat down, I doubt that they even knew whose flat it was. The only truth seems to be that he visited the USA in the 1950s, leaving behind him components of two experimental water turbines; the objects that Zundel (who adorned them with Nazi insignia) said flew.

I have been told, all too often, not to use the term '*Nazi UFOs*', because this is really about secret and suppressed technology. It just happens that the Germans were clever enough to invent it, and even if **Ernst Zundel** (image right) manufactured or exaggerated some of the facts, then he only did it for the money.



On '*The Zundelsite*', in the '*Zundelsite Zgram*' for 26 December 1998, the matter is explained in his own words. He says of his publications and his radio appearances:

"I realized I had discovered a potent publicity tool with this topic – which would get me lots of free time on radio and TV shows, to expose other, more 'politically incorrect' topics to vast audiences... I slipped in lots and lots of 'Revisions of History'... I talked about the disinfecting procedures to protect the valuable worker inmates in the Dora-Mittelwerke rocket underground assembly factories...

I mentioned the medical facilities in the camps, the calorie count of the meals served, etc... The UFO books themselves also had very important politically otherwise impossible-to-tell messages embedded within them, such as the *National-Socialist Party* program and Hitler's analysis of the Jewish question...

All that – and I made a fine bundle of money! The money I made from the UFO books I invested in publishing the booklets *Die Auschwitz-Lüge* - a translation of *The Auschwitz Lie*, Dr Austin App's booklet *The Six Million Swindle* and *A Straight Look at the Third Reich*; and, of course, later, *Did Six Million Really Die?* by Richard Harwood."

If Zundel's own account is to be believed – and I think it probably is – then his *fictions about Nazi UFOs* have funded the distribution of Holocaust revisionist material around a substantial part of the world.

So, at the end of the day, there's more at stake here than just tall tales and technological fantasies; there would appear to be a good *ethical argument* to *stop repeating such fictions* and to put the '*Nazi UFO*' mythos to *rest* once and for all.

Return

Secrets of...

# The Third Reich

from [Violations](#) Website

Book IV

Secrets of The Third Reich

Part I

Secrets of the Third Reich

**Part I**

The fact that the Germans were developing advanced technologies during the end of the war is a matter of public record. As **Sir Roy Feddon**, Chief of the Technical Mission to Germany for the Ministry of Aircraft Production stated in 1945.

"...I have seen enough of their designs and production plans to realize that if they (the Germans) had managed to prolong the war some months longer, we would have been confronted with a set of entirely new and deadly developments in air warfare."

**Captain Ruppelt**, Chief of the US Air Force [Project Bluebook](#) added in 1956, "When WWII ended, the Germans had several radical types of aircraft and guided missiles under development. The majority were in the most preliminary stages, but they were the only known craft that could even approach the performance of objects reported to UFO observers..."



Some of these German war-time technical advances were well known. The first military jet was the [German Heinkel 178](#) that flew in 1939. In 1943 the Germans also deployed the only jet fighter to go into regular service during the war, the Messerschmitt 262. This jet could easily overtake the fastest Allied aircraft, yet fortunately Hitler ordered that these planes should be fitted as bombers rather than defensive fighters which saved Allied aircraft from devastating casualties.



Then **Heinrich Focke** was involved in the design of and production of the FW6, Fa223, Fa226, Fa283 and 284 models during the war. He designed a propulsion system known as the 'turbo-shaft', which is still used in most helicopters today. Using this technology, **Focke** designed this upright, vertical take-off aircraft, which was just coming off the drawing board as the war ended. At the end of each of the three long arms of this technologically advanced craft was a small jet propulsion unit. The rotating arms were used to lift the body from the ground like the blades of a helicopter.

In 1939 **Focke** patented a saucer-shaped craft with enclosed twin rotors described as follows:

"The exhaust nozzle forked in two at the end of the engine and ended in two auxiliary combustion chambers located on the trailing edge of the wing. When fuel was added these combustion chambers would act as afterburners to provide horizontal propulsion to Focke's design. The control at low speed was achieved by alternatively varying the power from each auxiliary combustion chamber."

Cruise missiles were also first used by the Third Reich and **V-1 bombs** were launched from German occupied territories across the channel into England.

The next German rocket, **the V-2** proved to be the predecessor of the Intercontinental Ballistic Missiles that filled the arsenals of the former Soviet Union and US during the Cold War. This missile could travel 225 miles at five times the speed of sound and a single hit could take out a city block. The Germans also developed a rocket-powered fighter, the ME 163 and although it was never put into regular service, it was the first aircraft to fly faster than 600 miles per hour.

These then, were some of the known German advances. However there were also hints of darker technologies not fully understood. It was in 1944 that knowledge of these became public for the first time when the New York Times of 14<sup>th</sup> December reported "Floating Mystery ball is New German Weapon."

"Supreme Headquarters, Allied Expeditionary Force, Dec 13 - A new German weapon has made its appearance on the western air front, it was disclosed today. Airmen of the American Air Force report that they are encountering silver coloured spheres in the air over German territory. The spheres are encountered either singly or in clusters. Sometimes they are semi-translucent.<sup>(1)</sup>



## Floating Mystery Ball Is New Nazi Air Weapon

**SUPREME HEADQUARTERS,  
Allied Expeditionary Force, Dec.  
18—A new German weapon has  
made its appearance on the  
western air front. It was dis-  
closed today.**

**Alarms of the American Air  
Force report that they are en-  
countering silver colored spheres  
in the air over German territory.  
The spheres are encountered  
either singly or in clusters.**

'Where There's Feu, There's Fire.' Each side in the war seemed to believe that the *Foo Fighters* were the inventions of their enemy and several reconnaissance missions were launched to gain further information. To date, it has never been clearly established where the technology came from, and the origins of the foo-fighters remain an historical puzzle alongside the Scandinavian ghost rockets. What was clear, however, was that it wasn't Allied technology, and that was a serious cause of concern.

A typical incident was reported by a veteran pilot of the 415<sup>th</sup> Night Fighter Squadron. He was flying a mission over Hagenau, Germany on 22<sup>nd</sup> December 1944 when at 6.00am, whilst flying at an altitude of ten thousand feet, the pilot and his radar operator saw two "large orange glows" rapidly climbing towards them.

"Upon reaching our altitude' the pilot reported, the objects 'levelled off and stayed on my tail.' He went into a steep dive and the 'glows' followed in sharp precision. He banked as sharply as he dared and the objects followed. For two minutes the 'lights' stalked the fighter through several intricate manoeuvres, peeled off under perfect control, then blinked out..." (2)

The purpose of these strange objects was a mystery, for they merely followed warplanes, but apparently never opened fire or otherwise attacked them. These objects were named 'Foo Fighters', a term which came from a headline



Over the years fact and fiction regarding the exact nature of these advanced German technologies have become fused, however it is now clear that the Germans were developing craft that could be mistaken for what would nowadays be considered UFOs. In fact, such developments make perfect sense:

Each side during the war relied heavily on their aerial capabilities, and one sure way to disable such abilities was to take out enemy runways. Either side could have had the best air fleet on the planet, but without somewhere to take off from, such a fleet was impotent. Therefore the development of craft that did not require any runway, like **Focke's** designs, could potentially alter the eventual course of the war. As it turned out, the designs were only coming on line as the war ended, but had the conflict continued, it is conceivable that these new technologies could have altered the shape of history.



However, exactly what was being developed is now less a matter of historical record, and more of an historical jigsaw, with not only pieces missing, but other pieces conceived in the minds of writers who then peddled fictitious Nazi flying saucer myths to those who chose to believe them.

Establishing fact from fiction from over fifty years ago is no easy matter, and we are forced to consider information that is largely unverifiable. Yet when pieced together a plausible story of Nazi flying disk technology does begin to emerge.

One person who made claims regarding the development of 'flying saucers' in Nazi Germany is former Luftwaffe Flight Captain and aircraft designer **Rudolph Schriever**. He claimed in 1950 that he and a small team had worked at facilities near Prague developing a saucer-type vehicle.

This story first appeared in 'Der Spiegel' magazine on 30<sup>th</sup> March 1950 in an article entitled 'Untertassen-Flieger Kombination' which stated,

"... **Rudolph Schriever**, who says engineers throughout the world experimented in the early 1940s with flying saucers, is willing to build one for the United States in six to nine months. The 40-year-old Prague University graduate said he made blueprints for such a machine, which he calls a flying top, before Germany's collapse and that the blueprints were stolen from his laboratory. He says the machine would be capable of 2,600mph with a radius of 4,000 miles, Schriever is a US Army driver at Bremerhaven." (3)

His claims are backed up by a 1975 *Luftfahrt International Report* that noted that after **Schriever's** death in the late 1950s, papers found amongst his belongings revealed incomplete notes for a large flying saucer, a series of sketches of the machine and several newspaper clippings of himself and his alleged flying saucer. Up to his death, **Schriever** had repeatedly claimed that the UFO sightings since the end of the war were proof that his original ideas had been taken further with successful results.

Researcher **Bill Rose** was able to discover that Schriever was involved with other scientists **Klaus Habermohl** and **Giuseppe Belluzzo** (an Italian engineer) as well as one **Dr. Walter Miethe**. Rose's research established that Miethe had been the Director of the saucer programme at two facilities located outside Prague. We know little more about Miethe's activities at this time but it does seem that he knew **Wernher von Braun** (of whom much more later) as there is a photograph of them together in 1933.



We certainly do know that one scientist, **Viktor Schauberger** (image right), was involved in the production of flying disks, and that he flew one in 1945 near Prague, just as Schriever had claimed. His experimental prototypes were based on levitation. Born in 1885, Schauberger considered the natural world his greatest teacher although many in the world considered Schauberger to be somewhat deranged. In forests, alongside rivers, he studied what he considered life-enhancing energy, water and air vortices.

He argued that,

"Prevailing technology uses the wrong forms of motion. It is based on entropy – on motions which nature uses to break down and scatter materials. However, nature uses a different type of motion for creating order and new growth. The prevailing explosion-based technology – fuel burning and atom splitting – fills the world with expanding, heat-generating centrifugal motion."

**Schauberger** believed that energy production could instead use inward-moving cold-generating centripetal motion, the same as nature employs to build and enliven substances. Even hydroelectric power plants, **Schauberger** said, use a destructive motion – they pressure water and chop it through turbines. The result is 'dead water'. He built suction turbines that he considered enlivened and invigorated, resulting in clean, life-giving water downstream.



Schauberger also produced electrical power from a unique suction turbine using implosion principles and was later pressured into developing a propulsion system using the same principles applied to air.

His work came to **Hitler's** attention and his son (left) recounts the meeting between his father and Hitler:

"In June of 1934 my father was invited by the Reich's Chancellor **Adolph Hitler** to discuss his work. Hitler wanted to know about his discoveries and talk about the various possibilities and what his great plan was. And he said 'yes, I'm looking for a new technology that must once again harmonize with the natural order of things and that is my real programme.'

"Shortly before the meeting, Hitler as Reich Chancellor gave the two deputies his orders. The two had come to discuss **Herman Goering's** plan. And he said 'Viktor Schauberger, you will speak with the two Reich's deputies and tomorrow or by the latest the day after tomorrow a second meeting will take place. And he said to the two deputies 'I find the plan fascinating. Yes, we Germans will bring about a whole new science.'" (4)

**Hitler** wanted **Schauberger** to supervise the building of a new flying craft that could levitate without burning any fuel.

This idea for this new craft was based upon a discovery made by Schauberger a few years before of how to develop a low-pressure zone at the atomic level. The scientist claimed to have achieved this in a laboratory setting when his prototype whirled air or water 'radically and axially' at a falling temperature. Schauberger named this resulting force as 'diamagnetic levitation power' and noted that nature already used this direct or 'reactionary' suction force in weather generation, solar fusion stability etc.



**Schauberger** was given a team of scientists to help him with his work, and he insisted that these be treated as free men rather than prisoners of the Nazis. During their work, however, their research headquarters was bombed and they were all transferred to Leonstein. There they perfected the 'flying disc' powered by **Schauberger's** turbine which rotated air into a twisting type of oscillation resulting in the build-up of immense power causing levitation. **Schauberger's** prototype was then developed into a vehicle known as the Belluzzo-Schriever-Miethe Diskus, a machine built up to 22ft in diameter. These craft travelled at over 2000 km/hr and were planned to go over 4,000 km/hr. By 1945 they could reach 1300 mph and gain an altitude of 40,000 feet in less than three minutes. The craft was also noted to glow blue-green as it rose and left a silvery glow.





The Munich publication, 'Da Neue Zeitalter' wrote in 1956,

"**Viktor Schauberg** was the inventor and discoverer of the new motive power, implosion, which, with the use of only air and water, generated light, heat and motion."

The publication reported that the first unmanned flying disc, what to an observer would have appeared to be Nazi UFOs, was tested in 1945 near Prague, that it could hover motionless in the air and could fly as fast backwards as forwards. It was also reported to have a diameter of 50 meters.



Other evidence in support of this event had appeared earlier in an interview given on 18th November 1954 to the Zurich-based 'Tages Anzeiger'. One **George Klein** stated that he had witnessed Nazi UFOs flying saucer test on 14<sup>th</sup> February 1945 and that the craft had reached a height of 30,000 foot in three minutes and could travel at hundreds of miles an hour.

In this interview, Klein gave further information regarding developments behind the disks, claiming that some of the work had taken place at Peenemunde, where the V-2 rocket was being developed and where **Wernher von Braun** was director. **Klein** also stated that the stability of the craft had been achieved by using a gyroscope; the same method used by the Von Braun-Dornberger team. The research then moved to the Mittlewerke underground facilities near Nordhausen in the Harz Mountains.

The 'Bible' of the story of the development of the Atomic bomb, '*Brighter than a Thousand Suns*', also confirms these events:

"The first of these flying saucers, as they were later called – circular in shape, with a diameter of some 45 yards – were built by the specialists Schriever, Habermohl and Miethe. They were first airborne on February 14th 1945, over Prague and reached in three minutes a height of nearly eight miles. They had a speed of 1.250 mph which was doubled in subsequent tests." <sup>(5)</sup>

That these events occurred is also supported by former **CIA** agent **Virgil Armstrong** who commented:

"We know that in the early parts of the war there were certain factions of the Allied forces that did not believe he had a secret weapon and it wasn't until the Americans made much emphasis of this that they began to look at it seriously and indeed did discover that **Hitler** not only had a secret weapon, he had what we would call today a **UFO** or spacecraft.

## References:

- (1) New York Times 14th December 1944.
- (2) Lore, Gordon I. R. Jnr., and Deneault, Harold H., Jnr., 'Mysteries of the Skies; UFOs in Perspective' p. 116 Prentice-Hall, New Jersey 1968.
- (3) 'Der Spiegel' magazine 30th March 1950
- (4) Third Reich Video
- (5) Jungk, Robert, 'Brighter Than a Thousand Suns' p. 87

[Return to Menu](#) or [Go To Part II](#)

## Secrets of the Third Reich

### Part II

"He had one already off of the drawing board and flying and it was capable of 1200 miles an hour. Vertical take-off, 90° changes, much like a helicopter, and of course was far superior to anything the Allies powers had at that time. Secondly they knew he had another craft about to be up and going it was capable of doing 2500 miles per hours, which was double the original. Not only did it have the characteristics of the original craft, but it also had a laser weapon aboard it which capable of penetrating four inches of armour. Needless to say that really spooked the allied forces into making a redemptive attempt against him and bringing him ... into a state of capitulation." <sup>(6)</sup>

Bulgarian Physicist **Vladimir Terziski** also wrote the following about these **Nazi UFOs**.

"According to **Renato Vesco** ... Germany was sharing a great deal of the advances in weaponry with their allies the Italians during the war. At the Fiat experimental facility at Lake La Garda, a facility that fittingly bore the name of Air Marshall **Hermann Goering**, the Italians were experimenting with numerous advanced weapons, rockets and airplanes, created in Germany. In a similar fashion, the Germans kept a close contact with the Japanese military establishment and were supplying it with many advanced weapons. I have discovered for example a photo of a copy of the manned version of the V-1 –

the Reichenberg – produced in Japan by Mitsubishi. The best fighter in the world, the push-pull twin propeller Dornier-335 was duplicated at the Kawashima works."

This appears to be the extent of information that can be verified to a degree. However there is much more that 'fits' within the known facts, but cannot be verified independently and therefore may well be fiction portrayed as fact. That said, much of the following information does flow with the themes explored further in the subsequent chapters of this book.

Claims have also been made that **Nazi Occult societies** were involved in the development of such unconventional saucer craft. One such, the 'Vril Society' was allegedly 'channelling' messages from an alien civilization in the **Aldebaran solar system** and planned to develop a craft that could make physical contact with the civilization there. This may or may not be true; but there was certainly a high level of occult activity in mid-Europe at that time, and no doubt organizations did exist then with unconventional beliefs just as they do today.

Whatever the truth of this, by 1934 the **Vril Society** had apparently developed its first UFO shaped aircraft, known as the **Vril 1**, which was propelled by an anti-gravity effect. (This was the same year as **Viktor Schauberger** discussed his flying disk ideas with **Hitler**.)

The society then allegedly went on to develop this craft, and later - and again allegedly - produced the RFC-2. This craft was apparently 16 feet long and fitted with an improved propulsion system and for the first time, magnetic impulse steering. Interestingly, when in flight, it reportedly produced colour effects normally associated with **UFOs**.

Yet the RFC-2 was largely ignored with only the SS showing an interest in the Vril Society's work. An inner organization of the SS then set up its own SSE-4 department to develop new alternative technologies to ensure Germany no longer had to be dependent on external sources of energy and it began work on its own version of the RFC or Vril.

By 1939 the SS had produced the RFC-5, which it called the



**Haunebu 1** (click image right). In August 1939 the machine made its maiden flight and proved its viability, being more than 65 foot in diameter and offering considerable storage space. By the end of 1940 the RFC-2 (**Haunebu II** - click image left) had entered service as a reconnaissance aircraft and there is certainly photographic evidence to support this, for example an RFC-2 was photographed near Antarctica in 1940 (see next chapter.) It should be noted that there is scant corroborative and historically verifiable information to support these claims, however the design of the **Haunebu II** should be noted for future reference.

Whatever their exact nature, it appears confirmed that a range of alternative design aircraft were by now either on the drawing board, hovering above the ground, or crashing into it. Some of these designs proved viable and successes were being reported. On 17<sup>th</sup> April 1945 **Miethe** was able to advise Hitler that the V-7 had been tested in the skies above the Baltic. This particular craft was a supersonic helicopter fitted with 12 BMW Turbo aggregate engines.

During its first test it reached an altitude of 78000feet and then 80000 feet on its second test. Miethe reported that the



new craft could be powered by unconventional energy sources in principle. However these new technologies were coming on-line too late, for the war was already being lost and won.

Within months the Allies and Russians had poured into central Europe, **Hitler** was dead and the war apparently over.

And as soon as the war was over, ghost rockets started appearing over Scandinavia and within two years 'flying saucers' were being reported wholesale over mainland United States.

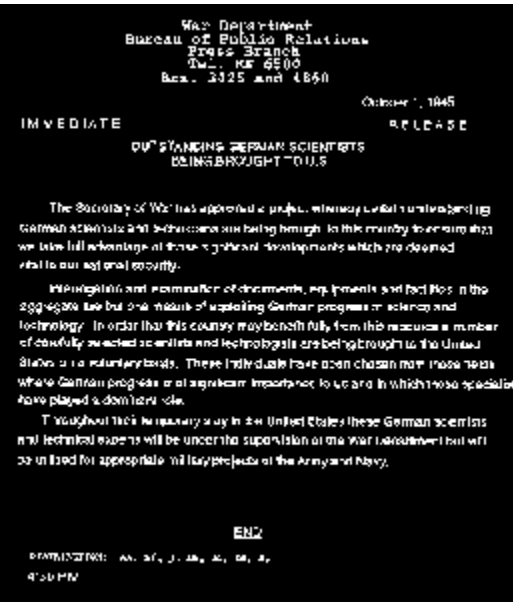

It was no co-incidence.

After the end of the war in 1945, Russian and American intelligence teams began a hunt to track down this perceived military and scientific booty of the advanced German technology. Following the discovery of particle/laser beam weaponry in German military bases, the US War Department decided that the US must not only control this technology, but also the scientists who had helped develop it "to ensure that [America] takes full advantage of those significant developments which are deemed vital to our national security."

It therefore launched a project to bring these personnel to the United States. Whilst initially publicized the nature, extent and secrecy of the project, later termed 'Operation Paperclip' remained classified until 1973.

The thinking behind **Paperclip** was exemplified in a letter Major General **Hugh Knerr**, Deputy Commanding General for Administration of US Strategic Forces in Europe, wrote to Lieutenant General **Carl Spatz** in March 1945:

"Occupation of German scientific and industrial establishments has revealed the fact that we have been alarmingly backward in many fields of research, if we do not take this opportunity to seize apparatus and the brains that developed it and put this combination back to work promptly, we will remain several years behind while we attempt to cover a field already exploited."

There was however, one slight problem: It was illegal, for US law explicitly prohibited Nazi officials from immigrating to America, and as many as three-quarters of the scientists in question were allegedly committed Nazis. (Indeed as at least 1600 scientists and their dependants were taken to America under **Operation Paperclip** and its successor projects, it could hardly avoid including Nazis.)

However President **Truman** (right) decided that the national interest was paramount and that America needed the German scientists to work on America's behalf. In fairness to Truman, he expressly ordered that anyone found to "have been a member of the Nazi party and more than a nominal participant in its activities, or an active supporter of Nazism or militarism" must be excluded from the operation.



Operation Paperclip was carried out by the Joint Intelligence Objectives Agency (**JIOA**) and had two aims:

- Firstly, to exploit German Scientists for American research by rounding up Nazi scientists and taking them to America
- Secondly, to deny these intellectual resources to the Soviet Union (7).

(The name 'Operation Paperclip' derived from the fact that those individuals selected to go to the United States were distinguished by *paperclips* on their files joining their scientific papers with regular immigration forms. (8)) The Joint Intelligence Objectives Agency (**JIOA**) then conducted background investigations on the identified scientists, and in February 1947 the Director of the JIOA, Navy Captain **Bosquet Wev**, submitted the first set of dossiers to the State and Justice Departments for review.

These dossiers, though, proved to be damning, with **Samuel Klaus**, the State Department's representative on the **JIOA** Board claiming that all the scientists in the first batch were 'ardent Nazis'. The visa requests were consequently denied. **Wev** already knew those proposed had Nazi backgrounds this for in a memo dated 27<sup>th</sup> April 1948 to the Pentagon's Director of Intelligence, he wrote

"Security investigations conducted by the military have disclosed the fact that the majority of German scientists were members of either the Nazi Party or one or more of its affiliates." (9)

**Wev** was furious and he fired off a memo to the State Department in March 1948 warning that "the best interests of the United States have been subjugated to the efforts expended in 'beating a dead Nazi horse'" (10).



The following month, 27<sup>th</sup> April 1948, **Wev** again wrote to his superiors concerned about the delays in approving the German scientists. He stated

"In light of the situation existing in Europe today, it is conceivable that continued delay and opposition to the immigration of these scientists could result in their eventually falling into then hands of the Russians who would then gain the valuable information and ability possessed by these men. Such an eventuality could have a most serious and adverse effect on the national Security of the United States." (11)

By this time the Nazi Intelligence leader, **Reinhard Gehlen** had met with the future **CIA** Director (26<sup>th</sup> February 1953 – 29<sup>th</sup> November 1961), **Allen Dulles** (left), and they had hit it off. **Gehlen** was a master spy for the Nazis and had infiltrated Russia with his vast intelligence network. (In 1942 the future **CIA Director Dulles** had moved to Bern, Switzerland, as *Head of Office of Strategic Services* to negotiate with some Nazi leaders who were already convinced they were going to lose WWII and wanted a deal with the US about a possible future war with

the USSR.) **Dulles** was not above pursuing his own agenda with the Nazis, for he had worked with many of them before the war; as a prominent New York lawyer (1926-1942 and again from 1946 to 1950)

When **Gehlen** surrendered to the US, he was taken to Fort Hunt, Virginia, where he and the US Army reached an agreement: his intelligence unit would work for and be funded by the US until a new German Government came into power. In the meantime, should he find a conflict between the interests of Germany and the US, he could consider German interests first (12). For almost ten years the 'Gehlen Org' as it became to be known, operated safely within the **CIA** and was virtually the CIA's only source of intelligence on Eastern Europe. Then in 1955 it evolved into the **BND** (the German equivalent of the CIA) and continued to co-operate with its US counterparts.

The scientists immigration problem was then side-stepped with the dossiers being 'cleansed' of incriminating evidence and, as promised, **Allen Dulles** delivered Gehlen Org, the Nazi Intelligence Unit, to the **CIA**, which later opened many umbrella projects based on earlier Nazi research.

Operation Paperclip also had a part to play in events at Maury Island. Washington State, itself, was the location of several aerospace defense contractors, which were benefiting from the then secret Paperclip Operation. It was also the location of sightings in 1947 of a number of aircraft that looked suspiciously like some that had been seen on Nazi drawing boards and in the skies above Europe towards the end of the war.

The officers who attended the *Maury Island incident*, **Davidson** and **Brown** belonged to G-2: It was G-2's responsibility to ensure Operation Paperclip was kept as a covert activity and provide the necessary security to achieve this. Another function of G-2 was the surveillance of anyone whose activities put Paperclip security at risk. That they were on their way to Wright-Patterson AFB with the objects **Crisman** had given them, was entirely logical – Wright Patterson (then Wright-Field) was the major research and development centre where many of the Nazi scientists had been taken to continue their work.

One of the most prominent of the Paperclip physicians was **Hubertus Strughold**, later known as the '*father of space medicine*' and after whom the Aeromedical Library at the USAF School of Aerospace medicine was named in 1977. His April 1947 intelligence report stated,

"[H]is successful career under **Hitler** would seem to indicate that he must be in full accord with Hitler."  
However he was admitted under *Operation Paperclip* on the grounds that he was "not an ardent Nazi."  
(13)

Other Nazis included **Klaus Barbie**, the so-called 'Butcher of Lyon', **Otto von Bolschwing**, infamous for his holocaust activities and the SS Colonel, **Otto Skorzeny** (14). However the cleansing of the files did not always stand up to the scrutiny of time. In 1984, **Arthur Rudolph**, who, in 1969 had been awarded *NASA's Distinguished Service Award*, left the country rather than face charges as a Nazi war criminal.

Another former alleged Nazi was **Wernher Von Braun**. Born on 23<sup>rd</sup> March 1912, von Braun became one of the world's first and foremost rocket engineers and a leading authority on space travel. Born the son of Prussian aristocrats **Baron Magnus** and **Baroness Emmy von Braun**, the young Wernher (right) read Hermann Oberth's '*By Rocket into Planetary Space*' (*De Rakete zu den Planetenaumen*), and his new interest led him to later enroll at the *Berlin Institute of Technology* in 1930. In 1932 he received his bachelor's degree in mechanical engineering and he was then offered a

grant to conduct and develop scientific investigations on liquid-fuelled rocket engines <sup>(15)</sup>. **Von Braun**'s rocket experiments were tested at the Kummersdorf Proving Grounds, sixty miles south of Berlin, between 1932 and 1937.

Kummersdorf was the launch site of two German V-2 rockets in 1934 <sup>(16)</sup>. After their launch, Braun started work on a jet-assisted take off vehicle for heavy bombers and all-rocket fighters <sup>(17)</sup> however **Kummersdorf** was too small for this task, and so **von Braun** relocated to **Peenemunde** on the Baltic Coast where he became director from 1937-1945. This site was then equipped with laboratories and industrial facilities to facilitate the development, production and testing of the German,

- V-1 (Vengeance Weapon 1)
- V-2 (Vengeance Weapon 2) rockets <sup>(18)</sup>

It was this **V-2 rocket** that inflicted such heavy damage on England during the war. **Von Braun** was not a reluctant Nazi. Indeed,

"he joined the National Socialist Aviation Corps, getting his pilot's license in 1933, the DAF trade organization, a hunting organization associated with the Nazis, the air raid protection investigation, and the SS horseback riding school <sup>(19)</sup>."

**Von Braun**'s own admissions in US Army records further show that he was a former SS Major who frequently visited the underground rocket factory where 25,000 prisoners from the concentration camp Dora had died. According to the former executive producer of CNN's investigative unit, **Linda Hunt**, **von Braun** attended a meeting that discussed rounding up of citizens off the streets of France to be taken to Dora.

As the war entered its dying throws in 1945, **von Braun** ordered two men to find an abandoned mine in the Harz Mountains to hide data about the V-2s. Several large boxes were then placed in a discovered cave and **von Braun** sent his younger brother **Magnus** off on a bicycle he had borrowed from a local innkeeper to look for Allies to whom they could surrender. **Von Braun** and his scientific staff duly surrendered to the US Army whilst most of the production engineers were taken prisoner by the Soviets <sup>(20)</sup>.

After entering America as part of **Project Paperclip**, on a pay of \$6 a day plus lodging in a military installation, **Braun** worked on guided missiles for the US Army. He returned to Bavaria in 1948 to marry his second cousin and he later served as Technical Director then later Chief of the *Guided Missile Development Division of Redstone Arsenal* from 1950 to 1956 whilst living in Huntsville, Alabama <sup>(21)</sup>. **Von Braun** was later appointed Director of Development Operations Division of the Army Missile Agency, which developed the Jupiter-C rocket that was to successfully launch the western's hemisphere's first satellite, 'Explorer-I' on 31<sup>st</sup> January 1958, auguring the birth of the American Space Programme <sup>(22)</sup>.

Two years later **von Braun** and his team were transferred to **NASA**'s Marshall Space Flight Centre where he served as Director from July 1960 to February 1970. During the 1950s and 60s he achieved an almost celebrity status as one of Walt Disney's experts on the 'World of Tomorrow'. In 1970 he became NASA's associate administrator and without him, it is unlikely that the organization would ever have put man on the Moon.

Over a course of twenty years, **von Braun** received approximately 25 honorary degrees and he accepted many other awards and medals, presented to him from small cities, to **NASA** and even the President. (Right - **Von Braun** with President **Kennedy**.)

His dossier was apparently rewritten so he didn't appear an enthusiastic (alleged) Nazi and he attempted to play down his real Nazi involvement by claiming

"In 1939 [sic] I was officially demanded to join the National Socialist Party. At this time I was already Technical Director at Peenemünde ... The technical work had ... attracted attention at higher and higher levels. Thus, my refusal to join the party would have meant that I would have to abandon the work of my life. My membership in the party did not include any political activity <sup>(23)</sup>."

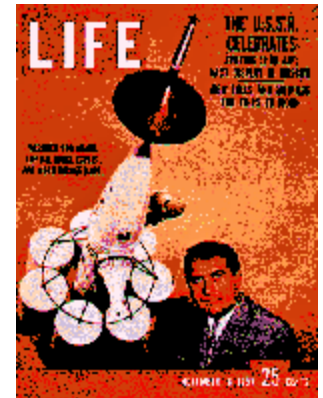



However, von Braun's claim was simply untrue, for other scientists successfully used an old rule of the Weimar Republic that was still in use, forcing anyone in the military to abstain from political affiliation.

**Wernher von Braun's** mentor, **Hermann Oberth** also entered the US after the war under Operation Paperclip. Born 25th June 1894 in the Transylvanian town of Hermannstadt, Oberth (left with von Braun) is widely recognized as the founding father of modern rocketry, having published the paper in 1923 that was to so inspire von Braun, '*Die Rakete zu den Planetenraumen*' (By Rocket into Planetary Space.) This was followed by a longer version (429 pages) in 1929 that was internationally regarded as a work of tremendous scientific importance.

When in his thirties, **Oberth** took **Wernher von Braun** (who affectionately referred to Oberth as his 'teacher') on as an assistant, and they worked together at Peenemunde developing the V2 rocket. After entering the US at the end of the war along with the remaining 100 V2 rockets and components, **Oberth** again worked with Von Braun as the entire Peenemunde team was re-assembled at the White Sands Proving Grounds. Oberth and Von Braun continued their work and it was a later development of the same V2 rocket which had inflicted so much damage on Northern Europe that was eventually to propel the first American into space in the Saturn V rocket. **Oberth** retired three years after entering the US and returned to Germany where he headed up the *Oberth Commission* for the German Government into **the UFO phenomenon**.

## References:

- (6) Ibid
- (7) Memorandum to Members of the Advisory Committee on Human Radiation Experiments 5th April 1995, from Advisory Committee Staff 'Post World War II Recruitment of German Scientists – Operation Paperclip'
- (8) Stuhlinger, Ernest and Ordway, Frederick III, 'Wernher von Braun: Crusader for Space' p. 67 Kreiger Publishing Company, Florida 1994.
- (9) Memorandum to Members of the Advisory Committee on Human Radiation Experiments 5th April 1995, from Advisory Committee Staff 'Post World War II Recruitment of German Scientists – Operation Paperclip'
- (10) Ibid.
- (11) Ibid.
- (12) Zapezauer, Mark 'The CIA's Greatest Hits'
- (13) Memorandum to Members of the Advisory Committee on Human Radiation Experiments 5th April 1995, from Advisory Committee Staff 'Post World War II Recruitment of German Scientists – Operation Paperclip'
- (14) Ibid.
- (15) Buckbee, Edward O., 'Biographical Data: Wernher von Braun' Alabama Space and Rocket Centre, 1983.
- (16) Stuhlinger, Ernest and Ordway, Frederick III, 'Wernher von Braun: Crusader for Space' p.15, Kreiger Publishing Company, Florida 1994.
- (17) Bergaust, Erik, 'Wernher von Braun' pp51-52, National Space Institute, Washington DC, 1978.
- (18) Dooling, David, 'Academic American Encyclopaedia' p. 134 Grolier Inc 1993.
- (19) Donefer, Charles, 'Wernher von Braun: National Hero or Enemy to the World?' 1996
- (20) Ibid p. 134
- (21) Buckbee, Edward O., 'Biographical Data: Wernher von Braun' p. 2 Alabama Space and Rocket Centre, 1983.
- (22) Ibid p. 3
- (23) DeVorkin, David H., 'Science With A Vengeance: How the Military Created the US Space Sciences After World War II' p. 26, Springer-Verlag, New York 1992.

**Return to Menu** or **Go To Part III**  
**Secrets of the Third Reich**  
**Part III**

**Another scientist who brought new knowledge to America was Viktor Schauberger. Although**

there is no evidence that Schauberger had Nazi sympathies, he was viewed by the Americans as a collaborator and put 'into protective custody' for six months at the end of the war.

Dr Walter Miethe, and Rudolph Schriever also entered America under Operation Paperclip, however it is believed that their colleague Habermohl fell into Russian hands.



Whilst in the US, Miethe continued his 'flying disk' work working primarily for the US Air Force, however he was sub-contracted to A. V. Roe and Company.

In 1959 Jack Judges, a freelance cameraman was flying over this company's plant in Canada when he saw and photographed this picture (left) of a disk shaped craft sitting on the ground.

After the photograph was published in the papers, speculation grew that the disk was a secret weapon, and one that may have accounted for many of the UFO sightings during previous years.

In response to the speculation, the US Air Force released the following official photograph of the craft. It was called the 'Avro' and had first been launched in 1955.

A CIA memo of that year confirmed that the craft was based work undertaken by German scientists, notably Miethe, during WWII. The design was later abandoned in the late 1960s with the Air Force maintaining it was still at an experimental stage when abandoned. The 1990s were to reveal the craft was part of the secret 'Project Silver Bug', a project to develop a craft that had VTOL (vertical take-off and landing) capabilities that would dispense with the need for runways – and reduce the risks of such runways been targets of attack thus immobilizing any aircraft that may rely on it.

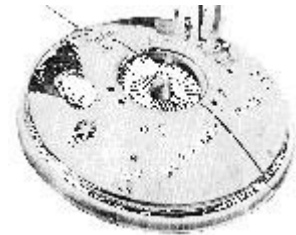

Other German scientists similarly brought their expertise – and designs – into the US after the war. 'America's Aircraft Year Book' notes how many of them worked at Ft. Bliss (von Braun et al above) and Wright Field: the first and second homes of the Roswell wreckage. Among those in the German group at Wright Field were Rudolph Hermann, Alexander Lippisch, Heinz Schmitt, Helmut Heinrich, Fritz Doblhoff and Ernst Zundel.

Hermann was attached to the Peenemunde Research Station for Aerodynamics where Germany's V-2 rockets were hatched and launched against England. A specialist in supersonics, he was in charge of the supersonic wind tunnel at Kochel in the Bavarian Alps. He was also a member of the group entrusted with Hitler's futuristic plans to establish a space-station rocket-refueling bases revolving as a satellite about the Earth at a distance of 4,000 miles – a scheme which he and certain high ranking AAF officers in 1947 still believed possible."



One of these scientists Dr. Alexander Lippisch had designed another German craft that could be mistaken at the time for a flying disc, certainly at least when viewed from the side.

Lippisch had developed a number of projects leading up to the war, having been inspired by witnessing a flight by Orville Wright in September 1909 when a boy of 14. By November 1944, Lippisch, along with his students, had constructed the DM-1 (left), a delta with 60° swept leading edges. This craft was later to be flown at a speed of 497mph under the power of a rocket motor, and was shipped back to the US at the end of the war along with its creator. The DM-1 was to inspire the design of many US delta-wing aircraft such as the F-102 and F-104.

Lippisch joined Collins Radio Company as an expert on special aeronautical problems and in

1966 founded the 'Lippisch Corporation'. He went on to develop the X-113A Aerofoil Boat before dying in 1976 at the age of 81.

Another craft that looked suspiciously like a 'flying disk' was the AS-6 (click right image). This craft was built by Arthur Sack following encouragement from Ernst Udet, Germany's Air Minister in 1939.



Constructed at the Mitteldeutsche Motorwerke Company, and completed at the Flugplatz-Werkstatt at the Brandis Air Base in early 1944, the plane was not a success, and not further developed.

A similar craft to the AS-6, the V-173, was built by 'Chance-Vought', and known as the 'flying pancake'. The V-173 has the honour of being the one occasion that the US authorities actually 'admitted' that technologies developed in Germany during the war years could account for the wave of UFOs seen over America in the 1940s.



The Navy released this picture of a V-173 in 1947 during the wave of UFO excitement generated by Kenneth Arnold's sighting and the headline of the saucer crash at Roswell.

The Navy stated that the V-173 (click image left) was the only craft in operation at that time that could in any way come close to the flying disks being sighted everywhere.

Certainly the V-173, or another development at Chance-Vought was mistaken for a UFO by a local resident Thomas C. Smith whilst working for the company a year before the famous Roswell incident.

In 1997 Smith disclosed his story which appeared in the Lancaster New Era newspaper in Lancaster, Pennsylvania on 12th July, 1997. In the article Smith stated he had seen a flying saucer, but not a visitor from another planet but one that "was a human-engineered, experimental aircraft nestled in a Connecticut hangar.

"My God, what is that?" the 20-year-old Smith wondered. 'It was standing there on these stilts.'

It reminded Smith of something out of Orson Welles' 1938 radio broadcast 'The War of the Worlds,' about a Martian invasion of Earth. Armed with U.S. government security clearance, Smith watched, he says, as the 40-foot-wide elliptical craft hovered 10 feet off the ground and flew away, driven by twin propellers. A pilot lying in a cramped cockpit guided the craft. Smith, now a retired 72-year-old executive, recalled the experience during the UFO frenzy created by the 50th anniversary of the Roswell episode this month. Does he have proof that a craft like the one he saw crashed in Roswell during a test flight? No, but he says he believes that theory is more probable than visitors from outer space.

At the time, Smith was a mechanical-engineering graduate just out of Penn State University. He was working for Chance-Vought Aircraft in Stratford, Conn., which was building planes for the U.S. Navy. Smith was testing the high-altitude bonding of a composite material: wood sandwiched between two layers of metal.

He says he was curious about what would be built with the material, and since he had security clearance, a supervisor led him into a guarded hangar. He was shown a new jet the company was developing, but his attention was attracted to the other craft in the hangar, a flying saucer made of the material he had been testing.

'It was very streamlined,' Smith recalls. The khaki-coloured saucer was a few inches thick at the edges to about two feet thick at the pilot's cockpit, which had a bubble window allowing the pilot to look forward and down at the ground. 'I saw him get in, and he lay down flat,' Smith says. The craft had two propellers and rudders in the back. Smith went back at night to watch test flights. The saucer, he says, would float straight up, then fly off.



'They'd get it off the ground and it would disappear' into the darkness, he says. He says there were reports in the area of unidentified flying objects. About the time he left Chance-Vought in 1947, it moved operations to Texas, where it would have better conditions for test flights, Smith says." (24) Thus, Chance-Vought moved to a state next to New Mexico the year of the Roswell crash.

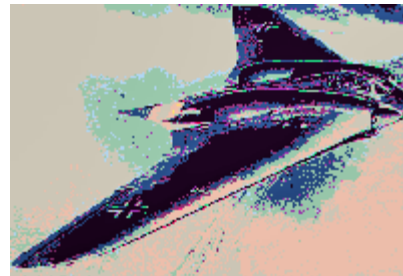

Other aircraft, at the time, seemed equally unconventional. In the 1930s and 1940s in Germany, the Horten brothers, Walter and Reimar, built a range of planes that they called the 'Ho' series. The first of this series, the Ho I, was a simple flying-wing sail plane.



By the end of that decade the brothers had developed the Ho III, a metal framed glider that was fitted with a folding blade propeller for flight. Then in 1944 they finished the prototype HO IX (click left), their first combat intended design, powered by the Junkers Jumo 004B turbojets, the craft had a metal frame and plywood exterior (Appendix I) It made its maiden flight on 2nd February 1945 and

satisfied with its performance, the Air Ministry ordered forty of the craft to be built by the Goetha Waggonfabrik under the designation Ho-229.



When the US Third US Army Corps reached the Goetha plant on 14th April 1945 they took over the factory, and shipped back to the US the near completed HO IX V3.

Another similar looking craft was this 'airplane' photographed in Germany at the end of the war.



In fact, many of these German designs seemingly account for many of the reports of Unidentified Flying Objects seen over the US after the war.

Kenneth Arnold himself described what he saw as a flying disc, yet when Arnold actually drew a picture of what he had seen, it looked little like the popularly conceived silver-round disc that readily springs to mind.

In fact, the diagram Kenneth Arnold actually drew of what he had seen that fateful day in 1947 looks remarkably like the German HO IX or other craft developed during the war.



George Adamski's UFOs also have a similar Nazi connection. This light enhanced frame from a 8mm cine film taken by George Adamski in the presence of Madeleine Rodeffer (Picture credit: Madeleine Rodeffer) and other witnesses at Silver Spring, Maryland in February 1965, looks remarkably like the drawings for the Nazi Haunebu II during the second world war.



Notice the bubble effects under the diagram of the Nazi craft and those captured in the alleged Adamski UFO. Indeed, it obviously is the Haunebu craft.

Again, this object photographed in February 1954 by Stephen Darbishire and his cousin Adrian Myers in the Lake District of England looks suspiciously like the German craft.

Its contours and design are too much like the Haunebu craft to be a coincidence, and on the bottom left hand side can be seen one of the 'bubbles'.

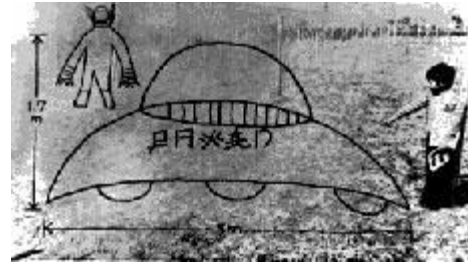

This following picture was drawn following an alleged UFO touchdown near Kofu City, Yamanshi Prefecture in Japan on 23rd February 1975 – thirty years after cessation of hostilities in Europe. According to the artist, an occupant came out of the craft and touched a child on the shoulder, temporarily paralyzing him. (Well, wouldn't you be startled if an alien touched you?)



The idea of such flying disks should come as no surprise for after the war there were a number of such designs in existence. This craft was developed by the Lockheed Skunk Works in Palmdale, California.

An unmanned aerial reconnaissance vehicle, it had a saucer shaped body with long wings and could easily be mistaken for a flying disk when seen at certain angles.

This craft (click below right image), is the prototype of a giant 'flying saucer' designed to revolutionize air transport. Designed by British firm, Airship Industries, the Skyship was planned to cruise at about 100 miles an hour at an altitude of 5000 feet.



It seems likely, therefore, that many of the UFO sighting reports made after the war can be accounted for by misidentified or unrecognized German/US designs that were being developed in a secrecy necessitated by firstly the Cold War and secondly by the fact that most of the technologies were the result of works undertaken by former Nazi scientists secretly and often illegally brought into the US.

Yet this cannot account for all of the sightings, for it is inconceivable that the CIA, NSA, FBI etc. would have been in such a blind panic as described in previous chapters had the sightings simply been known terrestrial if unconventional aircraft. (Each agency may not always have been aware of all developments at all times, but the official investigation into the UFO phenomena in the US went on officially for over twenty years, it would not be unrealistic to have expected a terrestrial explanation to have been circulated within that time frame.)

So if unconventional but terrestrial craft cannot account for many of the sightings – and the official interest – then what can. There have certainly been rumors circulating for many years that the German designs were actually man-made attempts to reproduce crashed real 'flying saucers' - attempts that failed because the engineers and scientists involved were unable to recreate the steering and propulsion systems of the alleged crashed craft.

As bizarre as this sounds, this claim certainly better explains the number of sightings over hundreds if not thousands of years and the inability of the major governmental agencies to account for much of the activity in the skies after the war. And it is a claim that is backed by some major players on the world stage.



One of the most impressive of those backing this claim is Colonel Philip J. Corso (Ret.) (left with Edwards O'Connor, Corso, Lt. Gen. Arthur Trudeau and Victor Fedaiy).

Corso published a book entitled 'The Day After Roswell: A Former Official Reveals the US Government's Shocking UFO Cover-up' in which he makes a number of revelations.

Corso's background itself is formidable. He was Chief of the US Army's Foreign Technology Division, and was a member of President Eisenhower's National Security Council. He later went on to work for Senator Strom

Thurmond after retiring from the army in 1963. Corso was interviewed by Michael Lindemann of CNI News on 5th July 1997 and asked:

ML: There have been rumours and speculations that Roswell, and what came from Roswell – the way we exploited Roswell technology – might not have been the very first time such a thing happened. There have been indications or speculations that the Nazis had done such a thing, that some of their extraordinary technological developments may have come from a similar source. What do you think of that?

PC: Yes. True. I had German scientists on my team. I discussed this with them. I discussed this with Oberth, von Braun. I was part of 'Project Paperclip' with General Trudeau... There were crashes elsewhere, and they [the Germans] gathered material too. The Germans were working on it. They didn't solve the propulsion system. They did a lot of experiments on flying saucers. They had one that went up to 12,000 feet. But where all, we and they, missed out was on the guidance system. In R&D we began to realize that this being [a captured alien] was part of the guidance system, part of the apparatus himself, or itself, as it had no sexual organs."

In his book Corso also describes the UFO that crashed at Roswell and noted General Twinning's observations regarding the design:

"The crescent-shaped craft looked so uncomfortably like the German Horten wings our flyers had seen at the end of the war that he had to suspect the Germans had bumped into something we didn't know about. And his conversations with Wernher von Braun and Willy Ley at Alamogordo in the days after the crash confirmed this. They didn't want to be thought of as verrückt but intimated that there was a deeper story about what the Germans had engineered."

(25)

Certainly this 'deeper story' was confirmed by the father of the modern rocket, Hermann Oberth. He independently confirmed that during the war years there was a Nazi-Extra-terrestrial connection when he stated,

"we cannot take credit for our record advancement in certain scientific fields alone. We have been helped."

When asked by whom, he replied, "the peoples of other worlds." (26)

Wernher von Braun was equally frank about the issue and did not doubt that extraterrestrials were visiting the Earth nor that many of the advancements he was involved in were a result of back engineering alien technology. Indeed, he talked openly about the issue following an incident on 3rd June 1959 when the 'Discoverer III' failed to achieve orbit, having been deflected whilst travelling. Von Braun commented,

"We find ourselves faced by powers, which are far stronger than we had hitherto assumed, and whose base is at present unknown to us. More I cannot say at present. We are now engaged in entering into closer contact with those powers, and in six or nine months it may be possible to speak with some precision on the matter." (27)

If these reports from Oberth and Von Braun are to be believed, then clearly the Germans held a knowledge not previously available to the Western allies.

And it appears that the scientists entering the US after the war under the auspices of [Operation Paperclip](#) shared this knowledge with the US military who within weeks set in place one of the fastest but little known invasions of the Twentieth Century.

References:

(24) Lancaster New Era newspaper, 12th July 1997.

(25) Corso, Philip, 'The Day After Roswell' p. 79 Pocket Books, New York 1997

(26) Collyns, Robin, 'Did Spacemen Colonize the Earth?' p. 236, Pelham Books, London 1974.

(27) 'News Europa' Jan 1959

[Return to German Disc Aircrafts - 1922-1945  
and Beyond](#)

# The Aldebaran Mystery...?

by Jim Nichols  
from [JimNicholsUFO Website](#)

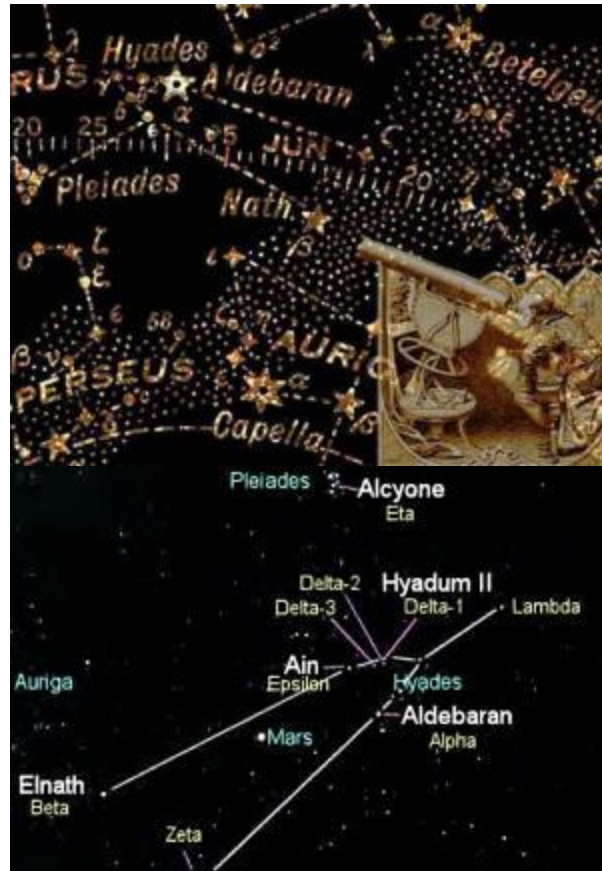

**Dr. Hermann Oberth, who pioneered rocket design for the German Reich during World War II and later advanced rocket technology for the American manned space launches, cryptically stated,**

**“We cannot take the credit for our record advancement in certain scientific fields alone; we have been helped.”**

**When asked by whom, he replied:  
“The people of other worlds.”**



**Oberth’s fellow associate space pioneer, who also served the Third Reich, Werhner Von Braun, echoed similar knowledge of the extra-terrestrial reality when he stated in 1959, “We find ourselves faced by powers which are far stronger than hitherto assumed, and whose base is at present unknown to us. More I cannot say at present. We are now engaged in entering into closer contact with those powers, and within six or nine months time it may be possible to speak with more precision on the matter.”**

**From "Above Top Secret" by Timothy Good, William Morrow and Company, Inc. 1988.  
Just who were “the people of other worlds” that Dr. Oberth spoke of so blithely?**

And were both of these esteemed German scientists making oblique reference to one of UFOlogy's most pervasive and tantalizing 'myths' - the alleged link between the Third Reich of pre-World War II Germany and... EXTRATERRESTRIALS?

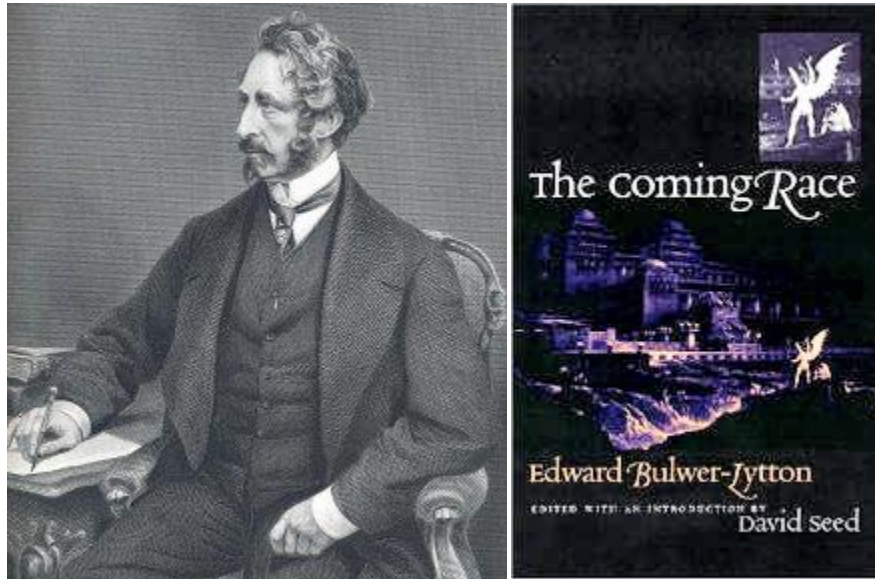

Following military defeat of the First World War, certain occult secret societies emerged in Germany intent upon discovering clues to the existence of ancient lost civilizations that once flourished on this planet; civilizations that reportedly possessed remarkable, almost magical technologies that allowed them mastery of the seas and the skies and even inter-stellar space travel.

Inspiration to rediscover such technologies were found in a novel published in 1871 by Rosicrucian author Edward Bulwer-Lytton, entitled, "[THE COMING RACE](#)". Lytton tells the tale of an intrepid explorer who discovers an advanced race of humans living within a vast subterranean world who call themselves "Vril-ya".

These beings had formerly been surface dwellers until a global catastrophe not unlike the Old Testament flood, forced them to take refuge deep in the Earth.

The survival of this marvelous society was facilitated by their application of a force they referred to as "Vril".

"...An explanation of which I understood very little, for there is no word in any language I know which is an exact synonym for Vril. I should call it electricity, except that it comprehends in its manifold branches other forces of nature, to which in our scientific nomenclature, differing names are assigned, such as magnetism, galvanism, etc.

These people consider that in 'vril' they have arrived at the unity in natural energetic agencies, which has been conjectured by many philosophers above ground..."

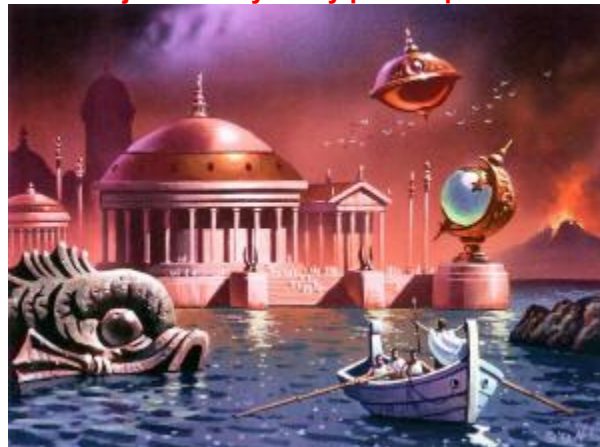

It was supposed by some that Lytton's book was not altogether a work of fiction, and in fact, he was privy to secrets that lost [Lemurian](#) and [Atlantean](#) artifacts still existed in clandestine caches hidden in the Gobi Desert and Tibet.

And indeed, ancient Sanskrit texts from India describe civilizations that flourished before the great flood that possessed technologies beyond the understanding of modern science.

The epic poem 'Saramangana Sutradhara', makes reference to the construction of amazing flying machines...

"Strong and durable must the body of the [Vimana](#) be made, like a great flying bird of light material. Inside one must put the mercury engine with its iron heating apparatus underneath.

By means of the power latent in the mercury, which sets the driving whirlwind in motion, a man sitting inside may travel a great distance in the sky.

The movements of a Vimana are such that it can vertically ascend, vertically descend, or move slanting forwards and backwards. With the help of machines, human beings can fly through the air and heavenly beings can come down to Earth."



German oriental scholars and occultists regarded such ancient myths with complete seriousness and during the lull between the First and Second World War, diligent efforts were put forth by both [the 'Thule'](#) and [the 'Vril'](#) secret societies to transform these myths into a viable technological reality.

Mastery of an occult force such as 'Vril' would not only assure German technical dominance—it would ultimately liberate Germany from any crippling co-dependence upon the international petroleum cartels dominated by Germany's conquerors—the United States and Britain.

Initiates of both the Thule and Vril societies were determined to develop an 'alternative science' and 'alternative technologies' based on principles possessed by the great 'lost' civilization of Atlantis:

"a spiritual 'dynamo-technology' superior to the mechanistic notions of modern science".

Thus to rediscover this source of universal free-energy and make it readily available as a benefit to the modern world became their goal.

Thule member, Dr. [W.O. Schumann](#) of the Technical University in Munich, declared, "In everything we recognize two principles that determine the events; light and darkness, good and evil, creation and destruction—as in electricity we know plus and minus. It is always; either—or..."

Everything destructive is of Satanic origin, everything creative is divine... Every technology based on explosion or combustion has thus to be called Satanic. The coming new age will be an age of new, positive, divine technology... "

Hence, the goal to harness 'Vril', Prana, the fundamental, limitless, cosmic life-force energy - a power source that would function harmoniously with our natural world - became an integral focus of these German secret societies.



The medium Maria Orsic was leader of the 'Vrilerinnen', the beautiful young ladies of the Vril Gesellschaft.

Characteristically they all wore their hair in long horse-tails, contrary to the popular short bobbed fashion of their day, claiming their long hair acted as cosmic antennas that helped facilitate their contact with extraterrestrial beings from beyond.

According to the legend of the German Vril society, a fateful meeting was held in 1919 at an old hunting lodge near Berchtesgaden, where Maria Orsic presented to a small group assembled from the Thule, Vril and Black Sun Societies, telepathic messages she claimed to have received from an extraterrestrial civilization existing in the distant [Aldebaran solar system](#), sixty-eight light years away, in the Constellation of Taurus.

One set of Maria's channeled transmissions was found to be in a secret German Templar script unknown to her. A second series of transmissions appeared to be written in an ancient eastern language, which Babylonian scholars associated with the Thule group, recognized as ancient Sumerian.

Maria Orsic along with Sigrun, another of the Vril Society's female mediums, began the task of translating these transmissions and discovered they contained instructions for building a circular flight machine.

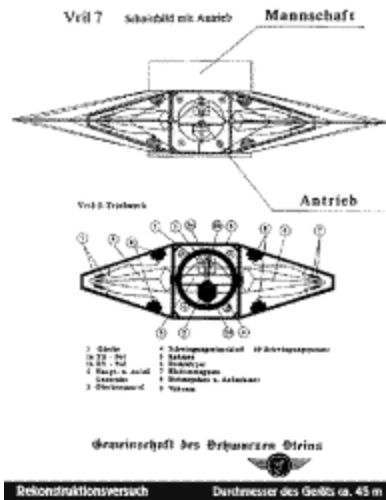

However, it should be important to consider the possible motivation behind the Aldebaran civilization's offer to assist [the Vril Group](#) and Germany.

Researcher Wendelle Stevens tells us that, rather than a militant gesture of aid to aggressive Nazis, the Aldebarans perceived an economic disparity in Earth cultures that fueled perpetual wars and conflict.

To alleviate this disparity the Aldebarans reasoned that by offering 'free-energy' technologies, used to create affordable mass transportation devices, a new innovative generation of industries, promoting prosperity and greater peaceful interaction between nations might result; thus diminishing violent wars.

Clearly such a plan resonated with members of both the Thule and Vril Societies and their dream for a utopian New World based on 'alternative science'.

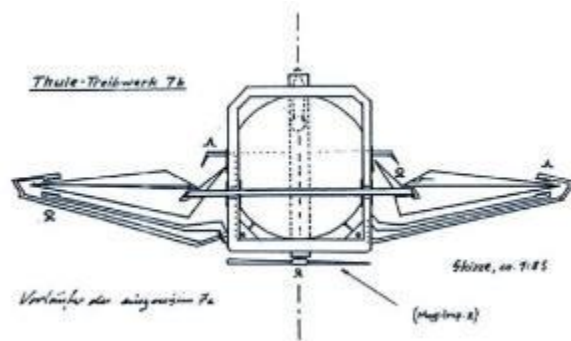

Upon studying these otherworldly, esoteric designs, Dr. [W.O. Schumann](#) and his associates from the University of Munich realized the channeling actually contained viable physics, and over the ensuing years construction was initiated to make this flying machine a reality.

By 1922 development of a working prototype was underway. Meanwhile, Germany saw the inception of the National Socialist Party and Adolph Hitler's rise to power, fueled in part by the utopian visions of a new world order inspired by the Thule and Vril Societies.

By 1934, the first manned test flight of the [RFZ-1](#) took place.

However, the results were less than auspicious. Flown by intrepid World War I ace, Lothar Waiz, the craft wobbled to altitude of 60 meters, and upon landing, the pilot, managed to escape from the craft just in time before it spun out of control, ripping to pieces like a drunken top. Before the end of that year a much improved version, the five meter RFZ-2, was test flown successfully and eventually flying disc development was taken over by Division SS E-IV of the Nazi military.



The fundamental physics were as simple as a child's spinning gyroscope - circular discs spun in counter-rotation create an anti-gravity effect; an effect as timeless as that described by the Old Testament prophet [Ezekiel and his 'fiery chariot'](#)—"a wheel within a wheel."

Had the Hebrew patriarch been witness to a flying machine from Aldebaran?

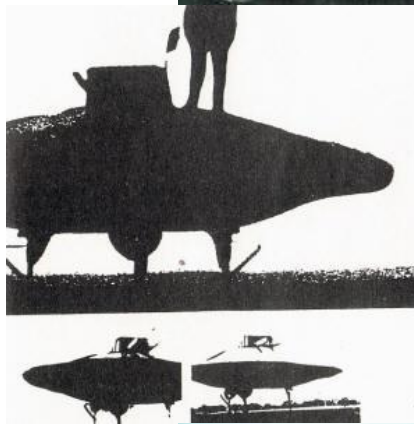

Contrary to his professed aim to create a world of cosmic harmony, Hitler sent his Panzer tanks and infantry into Poland in 1939, thus precipitating the altogether destructive Second World War.

And despite the fact that he also outlawed all secret societies in Germany, the Thule and Vril Gesellschafts maintained their autonomy, and development of Vril levitating saucer craft continued, despite funding competition from conventional Luftwaffe war-production imperatives. Aero-Technical Unit V-7 designed a number of hybrid saucers that combined both exotic anti-gravity and conventional turbojet propulsion systems, creating vertical lift craft that were essentially precursors to modern helicopters.

However, the distinctly separate SS E-IV Unit, bore the sole responsibility of developing Hitler's dream of free-energy propulsion.



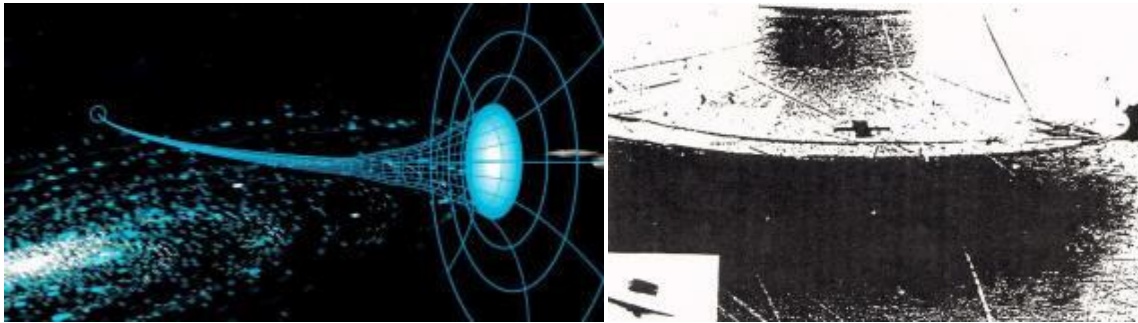

By Christmas of 1943, medium Maria Orsic of the Vril Gesellschaft, claimed that subsequent transmissions from Aldebaran revealed there were two habitable planets orbiting that star and that the ancient Mesopotamian civilization of [Sumeria](#) was linked to earlier colonies of Aldebaran explorers.

The seers discovered that the Aldebaran written language was identical to that of the Sumerians and was phonetically similar to that of spoken German. It was also revealed that a 'dimension channel' or 'worm-hole' existed connecting our two solar systems.

Thus in January of 1944, possibly aware that Germany's war efforts were faltering, Hitler and Himmler authorized an audacious plan to send a Vril-7 saucer ship into the dimensional channel, perhaps to secure assistance from the Aldebaran civilization.

The venture resulted in near disaster, the Vril-7 returned with its hull reportedly aged as if it had been flying for a hundred years and its surface damaged in several places.

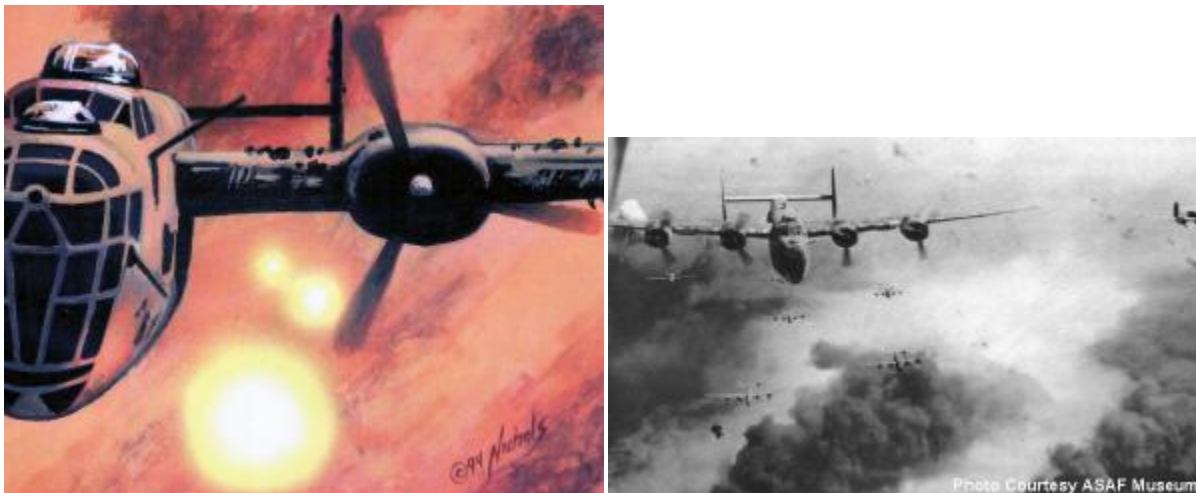

Meanwhile, the Allies sampled an unpleasant taste of the deadly weapons potential of German saucers.

In 1944 a massive bombing raid was launched against the critical ball-bearing plant at Schweinfurt. Within a matter of hours a squadron of ten to fifteen Nazi discs managed to shoot down as many as one-hundred and fifty British and American bombers - one quarter of the entire bomber contingent.

Still, facing overwhelming odds, the crumbling Reich lacked sufficient saucer squadrons to turn the tide.



**With the military fate of the Reich in doubt, an ambitious, energetic General rose within the SS inner circle elite to a level of power that rivaled perhaps that of even the Fuhrer himself.**

**Hans Kammler, a protégé' of Heinrich Himmler, had earned a reputation with his skills for rapid development and implementation of underground manufacturing facilities, and vast mobilization of slave labor consignments from concentration camps.**



**By 1945 Kammler had secured control over all top secret SS projects that were missile or 'aircraft' related.**

**Certainly Vril projects would have been one of his foremost priorities. Cunning and shrewd, Kammler easily bore the qualifications to master mind construction of 'special projects' facilities at the South Pole.**

**And as of April 17, 1945, Kammler disappeared from Germany, presumably escaping capture aboard a lumbering, six engine Junkers 390 Amerika bomber, bound for an unknown destination.**



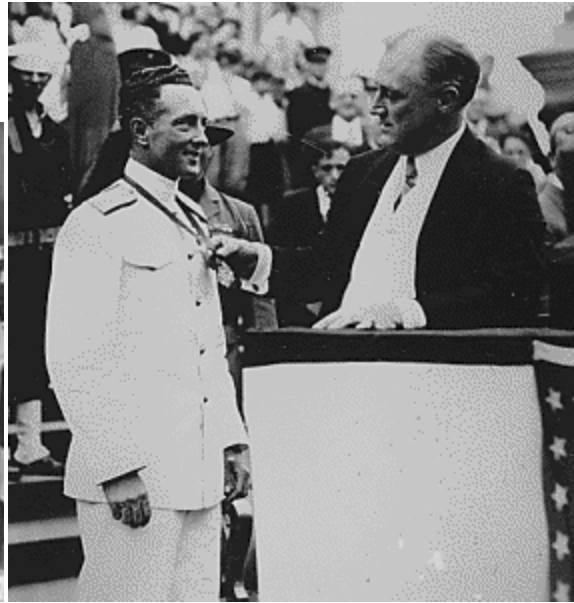

By inevitably seizing the rocket facilities and personnel at Peenemunde, the advancing Allied Army leadership was only too well aware of how dangerously advanced German technology had become.

Despite the Third Reich's unconditional surrender in 1945, a potential Nazi threat still haunted Allied intelligence. Had the German High Command sacrificed its European operation to buy time for installation of a 'fall-back' position in the Antarctic, capable of launching future retaliations from its South Polar redoubt?

Post-script to this legend is the account of "[Operation High-Jump](#)".

In January of 1947, an American military task force, complete with thirteen ships including, an aircraft carrier, seaplanes, helicopters and 4000 combat troops was dispatched to the Antarctic under the command of Admiral Richard E. Byrd, for the stated purpose of 'mapping' the coastline. This task force was provisioned for an eight-month polar stay, but after eight weeks and an undisclosed loss of planes and personnel, Byrd withdrew his forces.

Rumor was, Byrd encountered overwhelming hostile action, he described as, "fighters that are able to fly from one pole to another with incredible speed." He also intimated that he had in fact engaged a German contingent being assisted as well by an 'advanced civilization' with formidable technologies...

Whatever occurred with Byrd's expedition at the South Pole remains shrouded in mystery since all reports, including Byrd's personal log entries, remain classified.

Also, it should be noted that Operation High-Jump was originally organized by Secretary of the Navy, James Forrestal. But later, in 1949, Forrestal was sent to convalesce for a nervous breakdown at Bethesda Naval Hospital. However, after allegedly ranting to hospital staff about the Antarctic, UFOs and an underground Nazi city, Forrestal was denied all visitors and shortly thereafter, died in a fall from his hospital room window.

His death was labeled a 'suicide'.

But again, considering the question posed at the outset of this essay, could the 'advanced civilization' suggested by Byrd be the same extraterrestrials alluded to by both Von Braun and Oberth? Could these "people of other worlds" be Germany's mysterious allies from Aldebaran?

Such is the legend of 'Vril' and the Third Reich's levitating disc projects.

Of course, had all discussion of 'flying saucers' ended in 1945 it would be perfectly simple to dismiss the whole myth as preposterous nonsense. However, as we well know, persistent reports of UFOs and circular flying craft have remained a ubiquitous enigma worldwide for all the decades since World War II. And as long as this mystery goes unanswered the riddle of Nazi saucers will remain an urgent paradox that spins a kaleidoscope of demanding questions.

Viewed from the aspect of classical physics, the whole myth is easily dismissed as fanciful rubbish; the fairy tale notions of occult channeling with space brothers from Aldebaran, and Nazis armed with flying saucers and ray-guns sounds like the most outrageous science fiction!

However, this same legend reconsidered from the radically altered view of [Quantum physics](#) takes on dramatic plausibility!

- Was the Vril Society simply making practical application of the 'Unified Field'?
- Is Vril or "the unity in natural energetic agencies" that Edward Bulwer-Lytton described, far from pulp fiction, but a remarkably accurate description of zero-point energy that pervades the entire universe?
- Did ancient lost civilizations of Earth share understanding with extraterrestrial civilizations among the stars that the universe is in fact a single consciousness and simultaneously an ocean of limitless energy?
- Could it be that a handful of daring German visionaries discovered secrets of harnessing this energy?
- And ultimately, who were the REAL victors in World War II?
- Did a contingent of German physicists and engineers and military personnel successfully drop off the grid in 1945 and establish a new colony, totally self-sufficient and independent of the global petroleum cartels?
- And are the fundamentals of free-energy production fully known and deliberately withheld, at the cost of destroying our environment, merely to serve the greed of multi-national corporate and banking interests to this day?
- And is this 'free-energy' propulsion the ultimate secret behind the UFO cover-up?

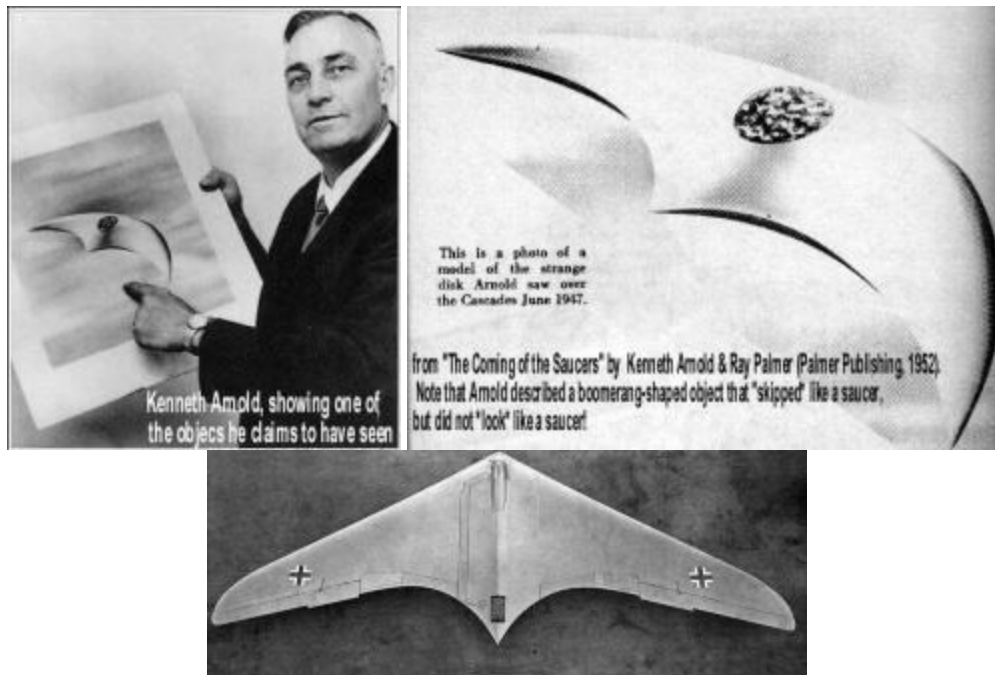

Of course, in the years immediately following World War II, the German saucer mystery compounded even more. In June of 1947 a private pilot named [Kenneth Arnold](#) reported a formation of nine shiny objects speeding along at an unprecedented speed of 1600 mph in the vicinity of Mt. Rainier, Washington.

In Arnold's words, the craft flew "like a saucer would if you skipped it across the water."

Hence the press seized upon his words and launched the public fascination with "Flying Saucers". However, Arnold actually described the craft as more crescent shaped, like 'flying saucers' - which coincidentally was another air form perfected by the German Horten Brothers, during the war.

It was suspected that captured German aircraft were being studied in a joint U.S./British facility in western Canada close to Washington state.



Four months later, in September of 1947, just eight months after Admiral Byrd's aborted mission to the Antarctic, the Strategic Air Command undertook a detailed mapping and reconnaissance mission of the North Pole.

An extensive B-29 support base was established at Ft. Richardson, Alaska. But aside from cameras, these bombers were crammed with state-of-the-art, electromagnetic scanners, sensors and magnetic emissions detectors. And, just as Byrd described, 'high speed craft capable of flying from pole to pole', were again encountered at the Arctic as well. Debriefed flight crews reported seeing metallic vertical lift saucers parked on the ice packs, flying in and out of the water as well as dogging the B-29s.

All evidence, tapes, film canisters and documentation were immediately classified and rushed back to Washington D.C.



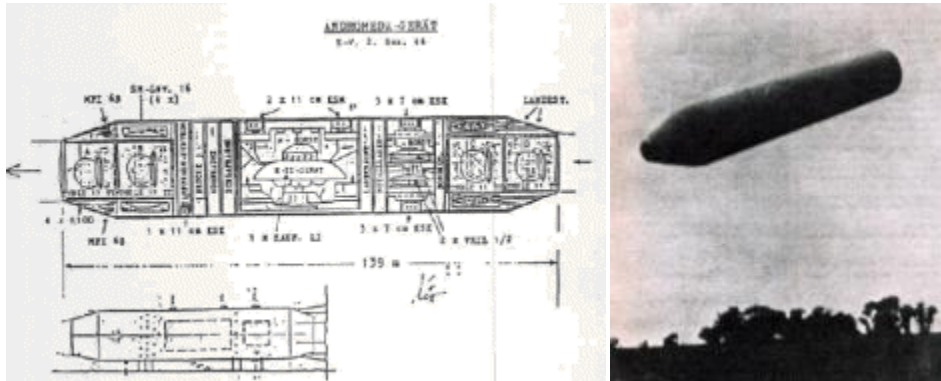

According to the captured records, the Germans also had plans to build a 'Zeppelin'-sized levitating cylinder ship called the "Andromeda" machine.

This 330 foot behemoth was capable of carrying as many as five of the smaller Vril and Haunebu scout ships. In the early 1950's a California man named George Adamski photographed a UFO remarkably similar to this design.

Later, Adamski claimed to have contact with a 'Nordic' looking extraterrestrial near Desert Center, California, who claimed to be from the planet Venus.





However, it should be noted that photographs of the little scout craft this alien flew show a design virtually identical to the German Haunebu II.

Though Adamski was later debunked as a fraud, reports of UFOs identical to the 'Venusian scout ship' continued to surface world wide.



In 1954, President [Dwight Eisenhower](#) was allegedly secreted away to a meeting with [Extraterrestrials](#) at MUROC airfield near Palm Springs, California.

One particular group was reported to be 'Nordic' looking and they offered Eisenhower Free-Energy technology in exchange for nuclear disarmament - Ike declined!

And as the story goes, these 'Nordic' ETs subsequently met with Pope Pius XII at the Vatican as well.

And of course it remains common knowledge that during the war Germany had cordial relations with Argentina and other Latin American countries, and by a curious coincidence even today UFOs are commonly reported the full length an breadth of South America, along with tales of hidden German bases in the ice peaks of Peru and the vast jungles of Brazil...



Consider this suspiciously familiar object allegedly photographed near Lima, Peru in 1973.

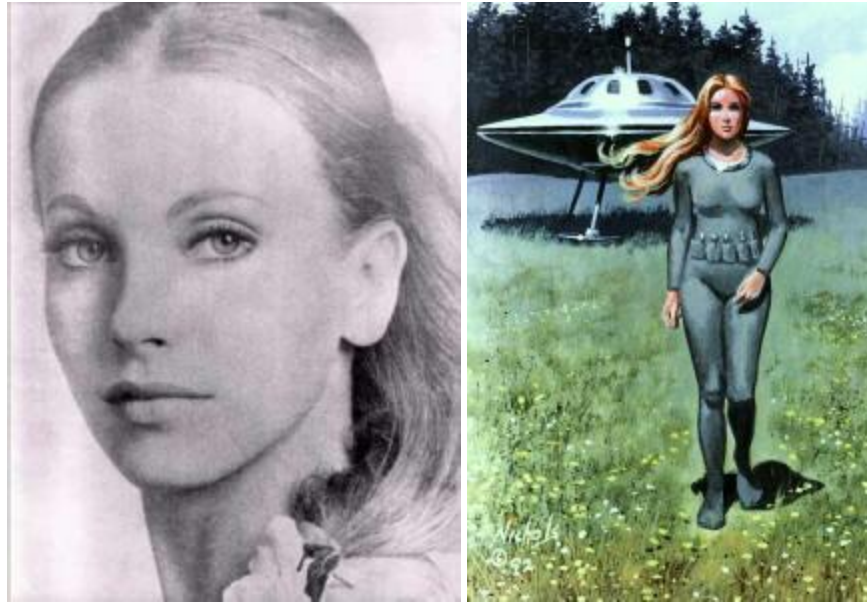

But perhaps the most blatant inference of a German connection with UFOs comes from the famed [Billy Meier](#) case in Switzerland.

In 1975, thirty years after the disappearance of the Vrtil society leaders, a Swiss farmer claimed to have contact with a girl from the '[Pleiades](#)', who bore the pseudonym, "Semjase" and a striking resemblance to the 'Vrtilerinnen' from 1919. This space girl also wore long blonde hair, spoke in fluent Austrian-German and candidly shared comprehensive knowledge about the German saucer projects of World War II.

Were Semjase's 'beamships' actually contemporary versions of the old Haunebus?

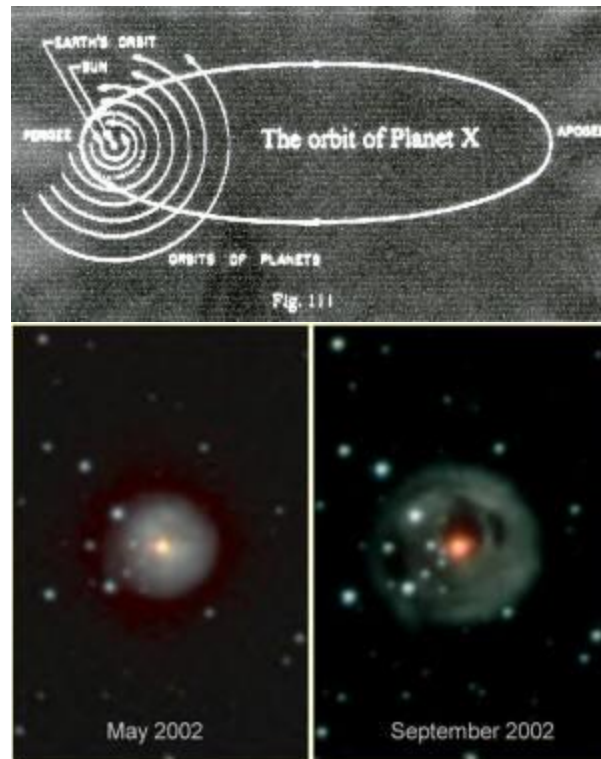

And yet, the riddle remains that, were the surviving modern remnants of the Third Reich to actually possess such vastly superior technology,

- Why then would they not simply flex their muscle and conquer the world in one final swift stroke?
- Or did they realize such a victory might ultimately be a futile gesture?

Suppose the Reich survivors learned from their Aldebaran mentors the secret the ancient Sumerians possessed - that, in a regular 3600 year cycle, the surface of planet Earth is devastated by the passing of a dwarf-star which is companion to our solar system.

And that this [Dark Star](#) was calculated once again to swing through the inner planets during the early years of the 21st Century.

Such a monumental event would grant the “Thousand Year Reich” a meager seventy year or so life span.

- Thus might the Reich survivors not wisely choose to disappear from the surface world and develop hardened underground 'shelters' in the remote wastes of Antarctica, patiently preparing to safely ride out the Dark Star's passing?
- Do we dare suppose that a contemporary generation of subterranean Reichskinder secretly continue to advance their limitless scientific wonders, content to allow the ignorant, expendable 'surface dwellers' to choke in the poisoned atmosphere of their internal-combustion, junk-technology, automobiles, airplanes and industries?
- Could it be that all the incredible levitating machines and free-energy technologies envisioned by the Thule and Vrill Societies are being carefully held in reserve for the promised 'New Age'; a future time when Earth has recovered from the agonies of its Dark Star's encounter...?

We may discover the answers to these questions sooner than we realize!

Meanwhile, the quest to solve the mysteries of Nazi saucers and the secrets from Aldebaran, certainly has gained more relevance to our present world here in the first decade of the 21st Century. It seems an irony that, much like pre-World War II Germany, we find Western Civilization dangerously dependent upon foreign petroleum sources dominated by hostile Muslim nations.

Is there a free-energy/anti-gravity answer to this dilemma?



And lastly, there has surfaced the mystery of the TR-3B. Allegedly one of the latest high-tech, USAF stealth aircraft rumored to be operational is [the 'Astra', otherwise known as the TR-3B.](#)

This craft is delta shaped and capable of vertical lift, as well as all the other radical moves commonly associated with UFOs. This baby comes in two sizes, one 300 feet long and one 600 feet long. Its propulsion is described as “Magnetic Field Disruptor” [anti-gravity], created by spinning mercury plasma at 50,000 rpms, pressurized to 250,000 psi.

This reduces the craft’s gravitational mass by 89%. Multi-mode impulse rockets at each corner of the delta configuration supply the remaining 11% propulsion. Could this plane be the ugly stepchild of the Haunebu III??

It is interesting to note that in ancient India, the name “Astra’ referred to a ‘terrible’ airborne weapon...

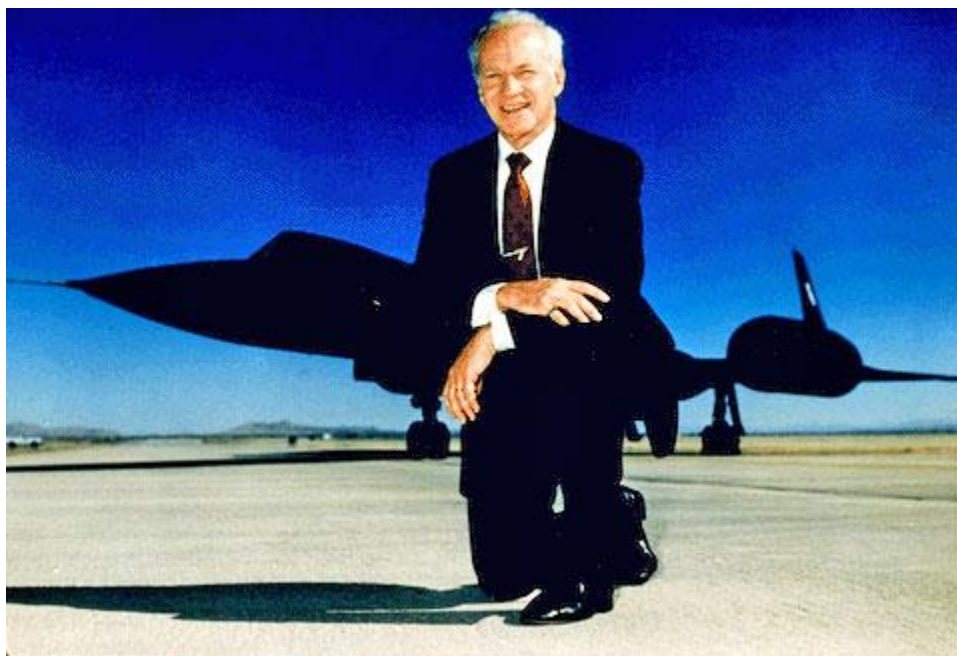

If such aircraft technology seems too far-fetched, one might consider this statement from former director of Lockheed’s [‘Skunk-Works’](#) at Area-51, [Ben Rich...](#) “We already have the means to travel among the stars, but these technologies are locked up in [‘black-projects’](#) and it would take an act of God to ever get them out to benefit humanity.”

Rich is also quoted as saying,  
“Anything you can imagine we already know how to do.”

---

#### Author's Disclaimer

The preceding text is virtually all 'legend'. There is no absolute, conclusive evidence to fully verify the authenticity of such a tale.

I've cobbled this together from the writings of Jan Van Helsing, Vladimir Terziski, Wendelle Stevens and a website called ['Grey Falcon'](#), as well as the video, UFO Secrets of the Third Reich.

Nick Cook's new book, [The Hunt for Zero Point](#), sheds important new light on advanced, hitherto unrevealed, Nazi technologies.

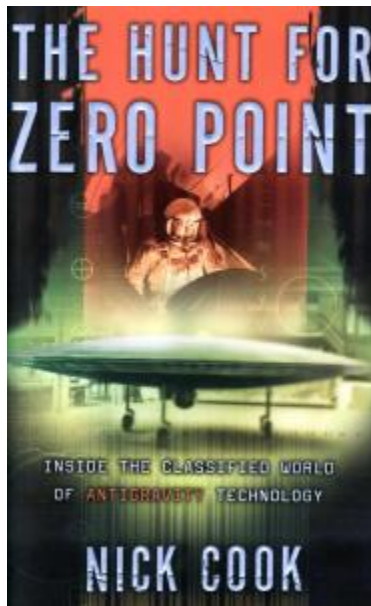

And in addition, I highly recommend two new books, Dark Mission, by [Richard Hoagland](#) and The Rise of the Fourth Reich, by Jim Marrs that follow the post-war trail of insidious covert Nazi influence into American politics, military and space exploration, right up to the present day.

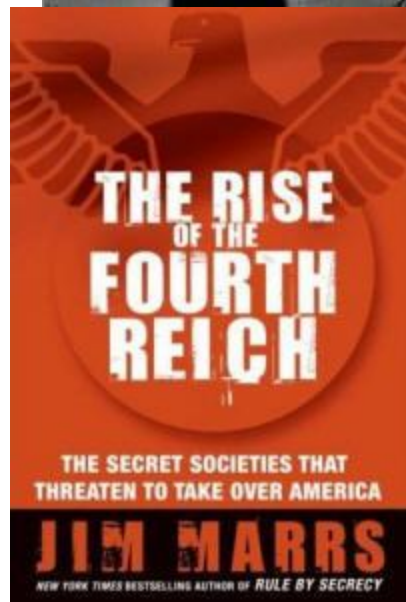

The bottom line has two options; either the whole story is pure fantasy, or Nazi secrets of anti-gravity were gobbled up at the end of the war by Allied Intelligence and given a security classification Above-Top-Secret, with all evidence meticulously hidden or destroyed.

However, it should be noted that anti-gravity propulsion systems, such as the Vril legend suggest, would make all aerospace and avionic technologies obsolete overnight - and these are huge multi-billion dollar industries directly tied to the international petroleum cartels. Surely these combined military/industrial interests would possess the means and the motive to obliterate any conclusive history of German anti-gravity research.

Allegedly [the Rockefeller](#) Foundation paid \$139,000.00 in 1946 to commission the publishing of an "official" history of World War II that deleted any and all references to the mystical and occult interests of the Third Reich.

One of the Rockefeller Foundation's major contributors was...Standard Oil!



[Return to Germany's ET Contacts? - Its Legacy On The Twentieth Century And After...](#)

[Return to The Saga of Flying Objects](#)

[Return to Temas / Vida Alienigena](#)

[Return to Vida en Nuestra Galaxia](#)

[Return to Contact and Contactees](#)

[Return to German Disc Aircrafts](#)

[Return to The Vrill Society](#)

# Cosmología de La India Revisada

...A La Luz de Los Hechos Actuales  
por Come Carpentier de Gourdon

Junio de 2011

del sitio Web ExopoliticsJournal

traducción de [Adela Kaufmann](#)

[Versión original](#)



*Exopolitics*  
**JOURNAL**

*Vol 1 No 1*

[www.ExopoliticsJournal.com](http://www.ExopoliticsJournal.com)



#### Acerca del autor

Come Carpentier De Gourdon es actualmente el Coordinador del Comité Editorial de la revista World Affairs, una publicación trimestral dedicada a temas internacionales, patrocinado por la Fundación Kapur Surya (uno de los patrocinadores del "Foro Público Mundial para el Diálogo de Civilizaciones") Nuevo Delhi, India.

Él se ha asociado con varias empresas y organizaciones sin fines de lucro. Ellos incluyen el Foro desarme nuclear y la Fundación para el Diálogo Global, Zug, Suiza (2001-2002), la Fundación Tissot Económica de Neuchatel, Suiza (1991-2000), la Comisión Mundial de Finanzas de las Naciones Unidas (de 1994 a la fecha ), el Grupo de Empresas FEGAWERK, Suiza (1991-1999), el Consejo Empresarial para el Desarrollo Sostenible (BUSCO, París, Francia, 1994-1995), Planet India Ltd., de Nueva Delhi, India (desde 1995 hasta la fecha), el Conferencia de Asuntos Internacionales de la Universidad de Colorado en Boulder, Estados Unidos (1985 a 1988), producciones de Orbita, Washington DC, Estados Unidos (1987 a 1989), la Fundación Juntos por la Unidad Global de Caracas, Venezuela y Boulder, Colorado (1990-1992 ) y la Academia Suiza de Ciencias Técnicas e Ingeniería (SATW) (1992-1993), entre otras.

Es autor de numerosos trabajos que incluyen una presentación en el Foro Mundial público del 2006 sobre "El Caso para Exopolíticas: Marcando el comienzo de un Diálogo Cósmico" Su sitio web es: <http://www.comecarpentier.com/>

## Abstracto

La literatura mitológica e histórica hindú, escrita a lo largo de más de tres o cuatro mil años, contiene una serie de referencias bastante detalladas de descripciones de seres vivos no-humanos, "semi-divinos y los diversos reinos visibles e invisibles, que en algunos casos parecen estar localizados en otras dimensiones de la realidad o en universos paralelos.

También hay cuentas y reportes de aeronaves y vehículos para viajes espaciales, así como de armas de guerra muy poderosas, capaces de provocar una destrucción masiva en zonas muy extensas.

Esos vehículos y herramientas, de acuerdo con esas historias, eran utilizadas tanto por dioses como por seres humanos.

Por otro lado, la evidencia científica contemporánea y las conclusiones oficiales de varios países señalan que esas naves espaciales extremadamente avanzadas, y de humanoides que eran aparentemente no humanos (probablemente "trans-dimensionales") son seres activos en nuestro planeta y en el espacio exterior.

Este documento establece una conexión entre aquellas conclusiones independientes, y sugiere que una visión actualizada y ampliada de [la estructura del universo](#) es necesaria, ya que la cosmología clásica es insuficiente para dar cuenta de muchas observaciones.

## Introducción

Los mitos y leyendas no son aceptados como hechos reales según los métodos, criterios y conceptos de la ciencia.

Son considerados, ya sea como relatos imaginarios, diseñados para proporcionar enseñanzas rituales y morales, y también como espectáculos culturales a la sociedad, o cuentas de ficción y simbólicas de acontecimientos antiguos, cuyo carácter y circunstancias originales fueron, en parte, olvidadas.

La escuela evermerista de pensamiento (nombrada según el mitógrafo griego del siglo 4 [Evémero](#), en consonancia con el enfoque escéptico de los filósofos de Cirenianos) considera a los dioses y a los seres sobrenaturales como representaciones de figuras humanas que fueron, en el curso de siglos o milenios, investidos con atributos humanos supra-divinos o heroicos.

Aunque hay evidencia de que esas interpretaciones socio-históricas se justifican en muchos, si no en todos los casos, también hay motivo para considerar otra forma de leer esas historias, sin perjuicio de la anteriormente

descrita exégesis. Ese sería el método objetivo, de mente abierta, visto en las descripciones y los hechos denunciados en la mitología y ve cómo podrían relacionarse con los eventos actuales o recientes, para los cuales tenemos pruebas científicamente admisibles.

Erich von Daniken es quizás el mejor conocido investigador y autor que ha llevado a cabo esta tarea, aunque, inevitablemente, muchas de sus interpretaciones, que son tan atrevidas como para estar en el límite exterior de la especulación, se han encontrado con la controversia y el a menudo el rotundo rechazo entre los principales académicos.

Debido a que se sabe que los mitos y leyendas son legibles en diversos niveles, desde lo literal a lo psicológico y lo metafísico, sin olvidar la dimensión histórica, no vamos a estar haciendo un flaco favor a esta antigua tradición, al aceptarlos en principio, como una buena cuenta de buena fe de acontecimientos reales, aunque, obviamente, los adornos literarios y errores inevitables hayan sido insertados en el transcurso del tiempo.

¿Cuáles son los factores que hacen que valga la pena e incluso hagan necesario tomar este punto de vista fáctico, libre de prejuicios?

En primer lugar, los sistemas hindú tradicionales de la cosmogonía, la metafísica y la cosmología fue tomando forma durante muchos siglos, si no miles de años y fueron vistos como objetivos y precisos en varias civilizaciones en el área de influencia de la India. Siguen siendo respetados e influyentes en el país, en las áreas adyacentes y cada vez más, en las regiones del mundo en donde varios aspectos de la cultura hindú-budista, tal como el yoga y las prácticas religiosas son conocidas y seguidas.

Por otro lado los recientes descubrimientos científicos tienden a apoyar algunas de las conclusiones y observaciones registradas en muchos de los textos indios filosóficos y técnicos.

En segundo lugar, los fenómenos repetidamente observados y confirmados científicamente no encuentran una explicación satisfactoria de acuerdo con los principios y teorías científicas, mientras que se contabilizan en la cosmología tradicional hindú.

Por lo tanto, puede ser útil o incluso necesario volver a examinar el cosmos representado por los [textos Védicos](#) y Puranas, con el fin de dar sentido a algunos aspectos enigmáticos de la realidad universal a la que nos enfrentamos.

## Espacio y Tiempo

La ciencia "moderna" se desarrolló bajo la influencia de la racionalidad materialista que sacó sus principios, en parte de la obra "[navaja](#)" del teólogo medieval [Guillermo de Occam](#).

Un efecto de esta actitud es que la astronomía científica (occidental) tuvo su comienzo del mínimo común denominador en cuanto a sus supuestos sobre el espacio y el tiempo y desde un principio descartó las antiguas cronologías Indias, las cuales eran consideradas como extravagantes e inverosímiles, especialmente cuando son comparadas con los registros bíblicos hebreos que colocaban la creación del Universo apenas hace sólo seis mil años (4004 A.C.).

En el siglo XIX, los astrónomos estaban todavía muy tímidos en sus cálculos cosmológicos y sólo unos pocos visionarios, como el astrónomo **Camille Flammarion**, se atrevieron a describir el universo como posiblemente infinito, o al menos inconcebiblemente grande. Sólo a regañadientes sus sucesores admitieron que la Vía Láctea era una galaxia conteniendo miles de millones de estrellas y les tomó aún más tiempo darse cuenta de que era sólo una de un gran número de galaxias similares o mayores.

Las escalas de tiempo no se expanden fácilmente en las mentes de los científicos.

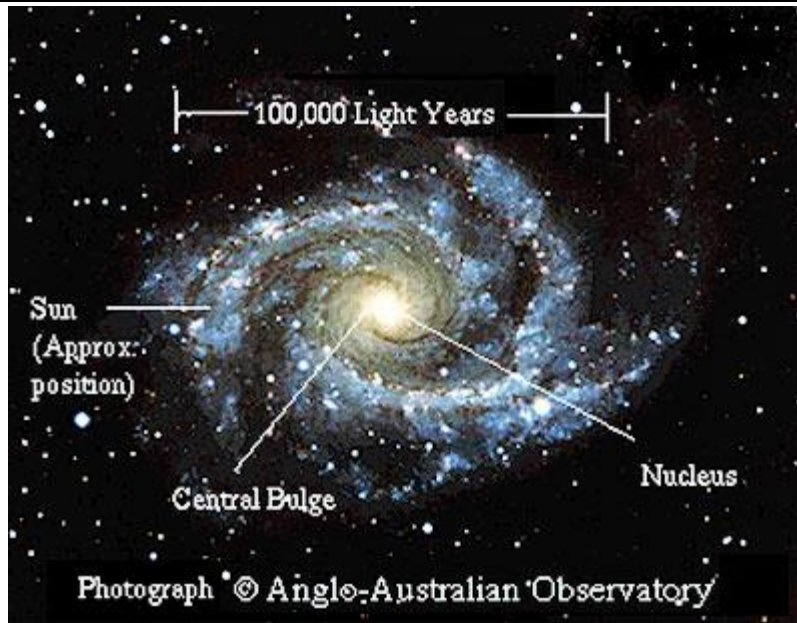

Por lo tanto, las órdenes de magnitudes de los,

- [yugas](#)
- devavatsaras
- caturyugas
- devavatsaras
- mahayugas
- manvantaras
- kalpas,

... de Escrituras de la India, que abarcan miles de billones de años solares permanecieron prácticamente fuera de su alcance intelectual hasta los avances logrados en los telescopios y en la observación astrofísica en la primera mitad del siglo XX, gradualmente se fueron reconciliando con el hecho de que el universo no sólo es más grande de lo que nosotros imaginamos, sino que también, posiblemente, más grande que podemos llegar a imaginar o medir.

A la luz de la ciencia, el registro bíblico acerca del cosmos fue hecho por Dios en seis días hace apenas unos cuantos miles de años aparece como comparativamente primitivo y, contrario a la teoría del progreso humano lineal, las antiguas civilizaciones fundadas en mitayos cosmológicos similares aquellos de la India, China, África o las Américas pudiera decirse que han retrocedido intelectualmente cuando aprobaron la "ciencia" que vino con el cristianismo.

Hay evidencia de que muchos de los textos recopilados y ensamblados en la Torá o Antiguo Testamento proceden de fuentes mucho más antiguas y sostenían un significado simbólico, significando que se había perdido todo cuando fue promovida la interpretación literal.

Las estimaciones de la astronomía contemporánea para la edad y el tamaño del cosmos y de sus galaxias y las estrellas son ahora ampliamente congruentes con los números que se encuentran en las escrituras hindús. Por otro lado, las teorías de la creación y la materia expuesta en ellos todavía están fuera de los límites de la actual visión científica del mundo, que los describe como "visiones místicas" o especulaciones no probadas a pesar de que en realidad no se pueden refutar.

Sin embargo, el hecho de que algunos anales "mitológicos" son asombrosamente exactos o por lo menos plausibles en sus evaluaciones matemáticas deben incitar a los físicos a echar un vistazo más de cerca a las descripciones "indias", de la estructura de la realidad.

Se puede decir en unas pocas líneas que las diversas escuelas de hindúes, budistas y jainistas de física enseñan que hay varios campos paralelos de realidad dentro de nuestro universo, compuesto por diferentes sustancias, o, más exactamente, de la misma sustancia en diferentes niveles de densidades. El material subyacente, desde donde se origina todo, es indefinible, pero que generalmente es llamado Brahman o Prakriti, que puede definirse como el suelo original de la conciencia.

Podemos detectarlo en lo que la astrofísica contemporáneo llama materia oscura del cosmos, que parece que conforma hasta el 96% del total.

A partir de ese sustrato inicial surgen una serie de reinos, primero el causal (karana), el sutil (süksma) y, finalmente, el campo de la material física o bruta (sthula), compuesto por las combinaciones de los cinco elementos básicos - en realidad, "estados de campos de energía "que nosotros definimos como éter, fuego, aire, agua y tierra - en diversos grados.

Por lo tanto, lo que podemos experimentar y observar de acuerdo con nuestros métodos científicos es todo o casi todo en este mundo particular de la materia, llamado Bhu que está rodeado y permeado por otros trece [lokas](#) (la palabra griega logos se deriva de la misma raíz, como es el latín *locus*: lugar), en orden descendente seis planos superiores:

- Satya
- Jana
- Mahar
- Svava (el cielo de los devas o seres brillantes)
- Bhava y los siete inferiores, mundos subterráneos, a veces impropriamente descritos como infiernos:
  - Atala
  - Vitala
  - Sutala
  - Talatala
  - Rasatala
  - Mahatala
  - Patala

Esas esferas "concéntricas" pueden ser consideradas como lugares geográficos, situados por encima o por debajo de la superficie de la Tierra o incluso continentes físicos, pero estos nombres parecen ser generalmente de otros niveles de existencia, no topográficamente eliminados de la nuestra, pero paralelamente, desplegados en dimensiones extra-sensoriales que existen más allá de las tres años y media en la que vivimos (tomando el tiempo como una media-dimensión, ya que no podemos revertirlo físicamente a nuestro nivel de la realidad).

Algunas escrituras budistas, basadas en el mismo sistema cosmológico, se refieren a un sinnúmero de mundos que componen el "chiliocosmos" o galaxias extendidas por todo el espacio.

Se dice que el hombre se ha encarnado en este mundo (el *Kamadhatu* o reino del deseo) desde la esfera más alta de los devas Abhasvara (dioses de pura luz). Todos esos planos, muchos de los cuales son invisibles e imperceptibles para los "humanos normales" son considerados como llenos de vida como la nuestra.

Que contienen sus propios elementos, plantas y animales, incluyendo algunos similares a los seres humanos en forma y comportamiento.



Los mundos paralelos se encuentran en constante contacto con el nuestro porque, a diferencia de nosotros, la mayoría de sus habitantes son conscientes de nuestra existencia, nos observan y de hecho se entrometen en nuestro espacio-tiempo, por lo general "por debajo del radar" de nuestra conciencia.

Naturalmente, todo el tiempo que permanezcan en sus respectivos ámbitos, pueden escapar de todos los criterios de detección científica, ya que estos últimos se formulan en el supuesto de que sólo existe la creación perceptible y cuantificable.

Sin embargo, ciertos seres humanos también pueden acceder a esos otros mundos, ya sea debido a dones y poderes especiales o por medio de un entrenamiento intensivo psíquico y espiritual o de prácticas mágicas, que automáticamente violan las reglas del juego científico, establecido en la época de la Ilustración, de manera que sus experiencias son ignoradas como inválidas por definición.

Es revelador que los criterios de la pruebas que generalmente son confirmadas por la metodología científica, son consideradas insuficientes en los casos que violan las leyes de la naturaleza, tal como esta es definida por la "ciencia".

En esta actitud, el "establecimiento del conocimiento" se mantiene fiel al dogma:

*Non potest sicut non est: no puede ser, por lo tanto no es, o en una versión más suave "las afirmaciones extraordinarias requieren pruebas extraordinarias".*

El mapa espacial del cosmos que acabamos de esbozar es reflejado en un orden cronológico que ya hemos aludido.

Cada ciclo de vida, se dice que está dividido en cuatro edades duración y virtud disminuida: el Satya o Kriti, Treta, Dwapara y Kali yugas. Al desplazarse la creación más lejos de su fuente, su pureza se reduce y su luz disminuye.

La duración real de los yugas, que es interpretada diversamente según las fuentes consultadas, es menos importante que la noción de que a medida que disminuye la era, se desvanece el poder espiritual y la tecnología se vuelve cada vez más frecuente y sofisticada.

Ya que estamos en la era de Kali, a la que entramos hace más de cinco mil años atrás, nuestras facultades espirituales y psíquicas se dice que se han reducido a una mera sombra de su poder original, estamos presenciando el surgimiento de tecnologías avanzadas que nos permiten aventurarnos cada vez más profundamente en el espacio exterior y visitar otros cuerpos planetarios.

Las Escrituras Puránicas dicen que mientras que en el Satya Yuga, los humanos tenían todos los dones que ahora consideramos como sobrenaturales.

En el Treta Yuga tuvieron que utilizar los mantras (o fórmulas verbales) para acceder a esos poderes, o al control de sus [Vimanas](#) (vehículos voladores) y también sus armas (astras y shastras), porque la guerra se había convertido en un hecho de la vida para entonces. En el Dvapara Yuga, necesitaban yantras (signos y dibujos mágicos).

La ciencia y la tecnología son mencionadas e incluso descritas, pero son consideradas como muletas construidas por el ser humano en degeneración, con el fin de compensar la pérdida de las facultades naturales.

En el Kali Yuga, como era previsible, debieron ser construidas y operadas máquinas (kritakas) con metales y otras sustancias materiales, y propulsadas por energía física generada por la quema de sustancias o de otra manera el aprovechamiento de sustancias materiales.

Los Mantras, Yantras y Tantras todavía existen, aunque muchos, al parecer se perdieron, pero ya que su poder está en lo invisible o por lo menos en niveles de la existencia espiritual y psíquica matemáticamente imposibles de cuantificar, no son considerados relevantes por nuestros líderes tecnócratas e intelectuales. El poder de nuestras tecnologías está, por tanto, paradójicamente, arraigado a nuestras limitaciones como especie que ese descrita como una sombra de su glorioso ser original.

Después de haber hecho reportes sin sentido crítico de lo que se afirma en las Escrituras, podemos señalar que cuentas similares de la evolución son encontradas en muchos otros textos sagrados y antiguos a través de todo el mundo.

Hay una tradición casi universal detrás de la creencia de que la humanidad moderna es la encarnación descendiente de formas de vida muy superiores, y no el resultado de una larga y gradual progresión lineal, como lo sostiene la *moderna* Teoría de la Evolución (TdE).

Otras consecuencias importantes de la historia de la India tradicional sobre el mundo es que los medios materiales para transmitir el conocimiento y para el mantenimiento de registros, como la escritura y, más recientemente, la grabación o filmación no eran necesarios en épocas anteriores ya que la comunicación oral o telepática y la memorización eran métodos muy superiores para la adquisición y conservación de la información, y sobre todo la sabiduría.

Así, los progresos realizados en esas áreas no denotan ningún adelanto de la barbarie a la verdadera humanidad, sino que constituyen, en su lugar, un sustituto imperfecto de los poderes perdidos y las habilidades de nuestros remotos antepasados o predecesores en este planeta.

La extraordinaria calidad y profundidad de los remanentes textos védicos, aparentemente consignados en la memoria en forma oral durante incontables siglos, parecen confirmar el perfeccionamiento y la elevación de la civilización que ellos preservaron con una precisión perfecta hasta nuestros días.

El argumento de que se originaron en una cultura altamente evolucionada, dotada con técnicas espirituales y cognitivas ahora perdidas, por lo tanto, es plausible, y encuentra un eco en la doctrina de Platón, que describe la invención de la escritura como un efecto de la pérdida de la sabiduría primitiva.

## Otros Mundos y Sus Habitantes

Al contrario de los humanos modernos, las criaturas descritas a lo largo de la antigua literatura hindú y medieval, no han disminuido, sino que se han mantenido en su estado original, con todas las facultades y atribuciones que les son asignadas.

Aunque pudieran haberse vuelto más discretas, tal vez simplemente porque nuestro crecimiento en "densidad" física nos ha despojado de la mayor parte de nuestros medios extra-sensoriales de percepción. Como se dijo antes, la mentalidad materialista, escéptica o agnóstica que las sociedades occidentales han exportado a todo el planeta en los últimos dos o tres siglos, ha desempeñado un importante papel en la deportación de todo el saber tradicional con la "tierra de nadie" de las leyendas primitivas o ficción étnica .

Sin embargo, desde los orígenes, los textos indios registran a los seres humanos mezclándose e interactuando con los diversos dioses, genios y "demonios" (en el griego, ambiguo o "buen" sentido del término) y, a menudo se casaron con ellos, dando a luz a seres híbridos.

Algunos hombres y mujeres de gran mérito y talento se convertían en dioses y se elevaban al cielo más alto, mientras que otros eran semi-demoníacos y se movían libremente entre varios mundos. Ciertas criaturas sobrenaturales se dice que descienden de ancestros humanos, como los rakshasas que fueron engendrados por el [Rishi Pulastya](#) védico.

Este último es identificado como una de las estrellas en la constelación del [Carro de la Osa Mayor](#) (Pheida en la astronomía moderna) y por lo tanto su propia naturaleza es a la vez terrenal y celestial, al igual que los otros seis rishis demiúrgicos de la cosmología India. La Osa Mayor apunta hacia el Polo Norte o el eje cósmico, donde la cosmología védica localiza el santo monte Meru, el hogar de los dioses.

Allí está el origen del famoso simbolismo ártico "indo-ario" adoptado en determinados círculos esotéricos, de la Europa de los siglos 19 y principios del siglo 20.

Las ciencias de la yoga y el tantra son conocidas por dar a sus practicantes avanzados la posibilidad de explorar otras dimensiones y vivir por lo menos temporalmente en ellas, dependiendo del nivel de dominio alcanzado en las técnicas. Así, los universos paralelos pueden estar cerrados para los seres humanos más comunes pero no son tan misteriosos a los que conocen las enseñanzas de los videntes.

Entre los seres que viven en ellos, algunos de los más cercanos a los seres humanos son,

- pitris
- pisacha
- bhutas
- yakshas
- nagas
- gandharvas
- kinnaras
- ganas
- rakshasas
- asuras
- garudas
- suparnas
- vidyadharas
- devas

...sin ningún orden en particular.

Aunque no todos ellos, son descritos detalladamente, hay suficientes referencias a ellos en los textos Vedas y Puranas, así como en el Ramayana, el Mahabharata y en textos posteriores para formar una imagen bastante completa de lo que representan.

Muchos estudiosos han concluido que esas criaturas aparentemente sobrenaturales son, de hecho, caracterizaciones totémicas de las diferentes poblaciones tribales y naciones extranjeras, pero, aparte de esa interpretación naturalista, hay que ver también la posibilidad de que ellos son o han estado, de hecho, realmente en existencia, como muchas observaciones actuales podrían bien confirmar.

[Los Pitris](#) son entre los más cercanos a los seres humanos vivos. Al igual que los Manes griegos son las almas de los antepasados muertos que habitan [la dimensión astral](#). Los Pisachas y Bhutas son similares a los fantasmas o espíritus de la tradición occidental y, a veces tienen las características de los duendes.

[Los Yakshas](#) suelen ser espíritus protectores del pueblo y a menudo actúan como deidades guardianas de tesoros subterráneos, bosques y manantiales. Su monarca Kubera, que también gobierna sobre los gandharvas es el dios de la riqueza y el metal y es el "emperador" del barrio Norte o polar.

El reino yaksha, se dice que se encuentra alrededor del Monte Kailash en el Himalaya occidental, se llama Alaka y es rico en oro.

En la misma región están los Garuda, míticos hombres-águila o humanoides voladores, se dice que tienen caras blancas y cuerpos dorados, así como grandes alas de color rojo, y provienen de Hiranmaya y que son bastante similares a los Suparnas, también con rostros humanos y alados.

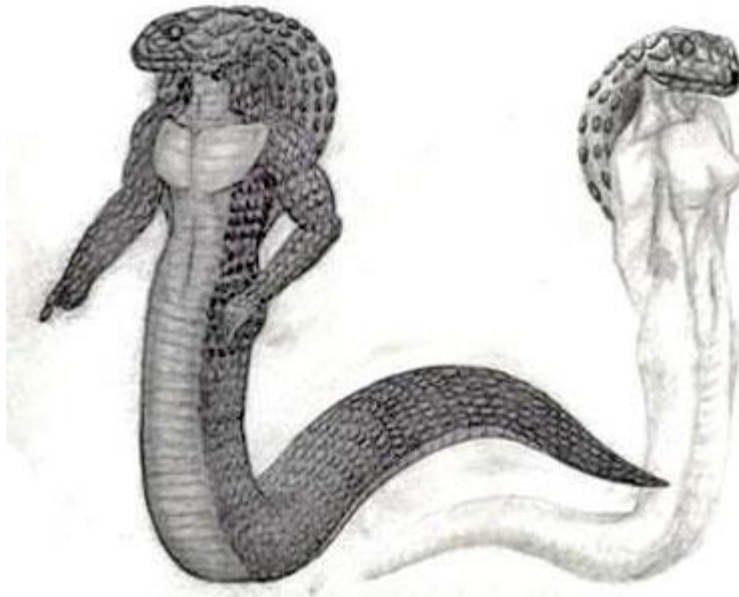

[Los Nagas](#), a menudo localizados en la misma amplia región - y cuya morada subterránea (el Patala) se sitúa en el Tíbet, que es accesible a través de una abertura secreta del mismo nombre, situada bajo el templo-palacio de Lhasa (el Potala) - se describen como serpientes o dragones pero pueden asumir formas humanas y, al igual que varios de esos fabulosos seres, de hecho, "cambian de forma", si optamos por utilizar un término contemporáneo de la ciencia-ficción.

Los Gandharvas, a la vez guerreros y músicos sirven a los devas y se dividen en veintisiete tribus, muchas de las cuales residen en los jardines encantados de Citraratha, al norte del Kailash. Ellos también son seres aéreos, cuyo ancestro o gobernante, se dice que es el gran músico rishi Narada.

Si los Apsaras evocan, tanto a los náyades, nereidas y valquirias de la imaginación occidental, por su apariencia y su relación con el agua y el cielo, los kimpurusas tienen caras de león, y son criaturas antropomorfas, y los kinnaras tienen cabezas de caballo, como Hayagriva, el icono "demoníaco" hindú y budista quien es a menudo llamado su líder.

Ellos tienen una clara relación etimológica con los centauros griegos (kentauri).

Sus consortes, los kinnaris, sin embargo, son mitad pájaro, mitad mujer. Los ganas son peces enanos, a menudo seres deformes que están asociados con minerales subterráneos y secretos, al igual que sus equivalentes occidentales (leprechauns o duendes) y su nombre es asociado con los genios árabes, de quienes se dice que son "hechos de puro fuego sin humo" (posiblemente de luz astral).

En un plano más elevado están los "dioses" más altos, los Rudras, Maruts, Adityas y Vasus que habitan en los reinos más sutiles. Significativamente uno de los Adityas (hijos de Aditi: el espacio infinito) es Tvastr, el arquitecto y constructor del universo y el carpintero de los vehículos voladores que acarrear los dioses a través de los cielos.

Entre los Asuras, los poderosos rivales de los [seres brillantes](#), está Maya ("el hacedor"), otro demiurgo cósmico que diseñó el Vimana Pushpaka, descrito en el Ramayana como el carro volador de Kubera "que parecía una nube de luz en el cielo", tomado de él por su envidioso y ambicioso hermano Ravana, rey de los Rakshasas de Lanka.

Los rakshasas son también super-seres humanos que tienen todo tipo de poderes mágicos y prodigiosos. Su nombre proviene de la raíz raksh: proteger, lo que indica que, aunque son considerados como fuerzas generalmente crueles y destructivos en el hinduismo clásico, (aunque capaces de "redención") originalmente eran ambivalentes, como la mayoría de otros tipos de humanos divinos, o supra-humanos.

Aún más enigmáticos son los vidyadharas (titulares de la sabiduría), seres semi-divinos, a menudo situados en remotas regiones del Himalaya y son descritos como poseedores de muchas habilidades fantásticas como



volar, cambiar de forma y hacerse invisibles. A veces son citados como asistentes de Rudra Shiva, el Señor de la Montaña Cósmica que es "el destructor de mundos".

Su monarca es Kandarpabali, de acuerdo con la [Hitopadesa](#) y ellos son los guardianes de la sabiduría tántrica y la ciencia "sobrenatural".

Muchos de esos seres son, en efecto, asociados con las grandes cadenas montañosas en la frontera India en el Norte y alrededor del Meru polar, según la geografía tradicional. Aunque muchos eruditos interpretan esta nomenclatura como describiendo, en traje mitológico, a las poblaciones tribales y reinos situados en la cordillera del Himalaya superior y en el altiplano tibetano, otros tienden a verlos como seres imaginarios con los que la fantasía poética rellena las inaccesibles fortalezas nevadas que cubren el horizonte.

Sin embargo uno también puede considerar la posibilidad de que haya habido grupos de seres "descendidos desde arriba" o de su domicilio boreal en las tierras altas, como lo registra la tradición chamánica original y prebudista de la religión Bon de del Tíbet.

Los libros de Bon tienen su origen en Dropa **Shenrab Miwoche** que, hace más de 18.000 años vino desde el reino oculto de Shambhala, volando en el Rig Tagzig Olmo Lug (espacio) y enseñando la forma original de la religión védica entregada a él por su propio maestro Shelha o Shiwa Okar (tal vez el Shiva hindú).



El [Mito de Bon](#) acerca de la fuente inicial de toda la sabiduría parece haber inspirado la doctrina budista de los Reyes ocultos (o Kulikas) de Shambhala, que tienen su sede en la maravillosa ciudad de Kalapa donde presiden sobre el rito secreto de la Rueda del Tiempo ( Kalachakra).

En total, serán treinta y dos señores de Shambhala, cada una gobernando durante un siglo, desde el primero, Suchandra, (Dawa Sangpo, en tibetano) hasta el último, Raudra Chakrin o Trakpo Cholkhorchen que vendrá en el siglo XXIV de la era común, con el contemporáneo ser Aniruddha o Nagakpo, el 21<sup>o</sup> en la línea.

En la cuenca del Tarim del Turquestán chino y las zonas periféricas, así como en Mongolia, hay muchas leyendas relacionadas acerca de Shambala y Agartha y algunos intrigantes restos arqueológicos (piedras Dropa y momias en Baian Kara Ula), llevand a los arqueólogos chinos a especular sobre orígenes "fuera de este mundo".

Es en esa amplia región que la cosmología taoísta sitúa el Hsi Tien, el Paraíso Occidental de la Señora de las ciruelas de oro de la inmortalidad, Hsi Wang Mu. Se dice que es la Tierra Santa de Asia Central de Belovodye

descrita por los viejos creyentes ortodoxos, Raskolniki.

El filósofo esotérico francés, **Saint Yves d'Alveydre**, en sus varios libros, particularmente en su Misión de l'Inde en Europe, escrito en 1886 bajo la inspiración de algunos maestros espirituales hindú, afirmó haber visitado Agartha en su cuerpo astral hace diez años y haber sido iniciado a su lengua sagrada, llamada Vatan.

Él lo describe como el centro neurálgico y principal santuario de Paradesa:

"La tierra más alta" en Samskrt, (el nombre de donde se deriva el paraíso, según él).

El sugiere que este reino es en parte subterráneo, debajo de los Himalayas y al menos parcialmente oculto en otra dimensión, lo que lo hace invisible e inaccesible para la mayoría de las personas que no son invitados a él.

Saint Yves ofrece varios otros detalles sobre este misterioso imperio cuya población se evalúa en unos veinte millones.

Añade que está rodeado por varios reinos tributarios, gobernados por sus respectivos Rajas y que esta confederación llega a cuarenta millones de personas en total. La jerarquía gobernante consiste, en orden ascendente de yoguis, panditas, bhagwandases (que son 360) y por encima de ellos, de doce gurús mundiales, encabezados por el triunvirato supremo de Brihatma (depositario de la autoridad espiritual), el Mahatma (encargado con poder jurídico) y el Mahanga que es el ejecutor ejecutivo.

Saint Yves, que era socialmente prominente y disfrutó de un gran respeto en los círculos esotéricos, estaba tan seguro de los conocimientos que había adquirido sobre Agartha, que escribió cartas al Papa, a la reina-emperatriz Victoria y al Zar Alejandro III de Rusia para ofrecer su introducción a los gobernadores de ese reino escondido, con el fin de permitir que el Mahatma y su corte de salieran al aire libre y pusieran a disposición el formidable tesoro de conocimiento acumulado en las grandes bibliotecas subterráneas mantenidas por los eruditos de Agartha en todo el planeta.

Él escribió que todos los registros de los tiempos pasados desde los albores de los tiempos y el conocimiento científico infinitamente más avanzado que el de sus contemporáneos, estaba disponible en esos archivos, recopilados en los últimos cincuenta y cinco mil años desde los días de Manu.

Citó al teólogo místico y erudito sueco del siglo 18, **Emmanuel Swedenborg**, que había descrito, viendo a través de sus facultades extrasensoriales, los anales de la historia olvidada de los orígenes humanos, enterrado en las profundidades de las estepas de Asia Central.

La tradición registrada por Yves Saint influyó en una serie de posteriores investigadores esotéricos, como **René Guenon** y **Fernando Ossendowski** y **Nicholas Roerich**.

Todos escribieron sobre o buscaron la morada del "rey del mundo" en algún lugar entre el Himalaya y Mongolia.

D'Alveydre indica que los habitantes y gobernantes de Paradesa son humanos, a pesar de que existen en un estado muy avanzado de evolución, lo que les da los atributos de divinidad, pero señala que en el curso de sus investigaciones sobre el universo, tanto debajo de la superficie de la tierra y en "las alturas", los Agartianos han descubierto varias especies inteligentes, algunos de los cuales son similares a los humanos mientras que otros parecen ser híbridos de hombres y varios tipos de animales.

Dice además que utilizan "dirigibles" (zeppelines) para explorar el cielo y en las regiones arriba, pero que esa podría ser una alusión a una nave espacial de un tipo desconocido para él, que en su edad, sólo se podía entender el principio de los aerostatos puesto que el principio de la aeronave "más pesada que el aire" era considerada como poco realista por la mayoría.

También vinculado a la tradición de Agartha están las leyendas de las ciudades subterráneas sagradas de Shonshe y Shangwa en el Turkestán oriental, refugios de la antigua raza celestial Uigur que se cree que abandonaron el mundo visible después de un gran cataclismo muchos miles de años atrás.

En el Mahabharata, a la morada de los Devas se conoce como [Uttara Kurus](#), al norte del Tíbet y del reino de los gandharvas (generalmente, equiparado con el actual Afganistán y Asia Central).

Pudiera ser la versión Samskrt del Homero Hiperbóreo.

## Vehículos Celestiales

Como hemos visto, algunas de las criaturas fantásticas aludidas en el capítulo anterior, ya sea totalmente "divinas", o al menos la mitad-humanas se dice que vuelan en carros celestiales, y ocupan armas extraordinariamente poderosas y tienen la capacidad de llevar a cabo muchas acciones mágicas, como el cambio de forma, aumentando su tamaño a proporciones colosales, o inversamente, la reducción a la escala de un mosquito o un átomo, y así sucesivamente.

Tales habilidades son, sin embargo también accesibles a los grandes yoguis, de modo que no hay una separación clara entre los seres humanos y otros seres vivos.

Las armas de los inmortales, que son un regalo de los dioses o adquiridas a través de una combinación de conocimientos técnicos y extraordinaria penitencia y concentración mental (tapas) tienen capacidades casi infinitas, como se demuestra a través de muchos Puranas, así como en el curso de las grandes epopeyas.

- la Agneyastra produce un fuego muy intenso que no puede ser apagado, y todo lo abrasa a cenizas
- Varunastra provoca lluvias diluvianas que inundan todo un país
- la Suryastra crea un resplandor que ciega y paraliza a todos los que lo ven
- la Vayavastra desata ráfagas o explosiones de aire como tornados que pueden derrumbar los más fuertes edificios y hacer estragos en el paisaje
- la sanmohana induce a la población objetivo o ejército en un trance colectivo o una alucinación
- la Tvastra desencadena tal confusión y pánico que las personas expuestas a él pueden luchar entre sí sin razón hasta la muerte

El chakra Sudarshan (o rueda de fuego) de Vishnu es irresistiblemente destructiva, pero sólo puede utilizarse una vez, porque el segundo lanzamiento funciona como boomerang y que puede aniquilar a quien lo dispara, así como a su tropa.

Se trata de un misil "inteligente" como lo indica el nombre de Sudarshan (que todo lo ve) y que esto irresistiblemente trae a la mente [la rueda celestial "llena de ojos", descrita por Ezequiel](#) en su profecía bíblica.

El kaumodaki es el mazo de Visnu, cuyos efectos también son devastadores e irresistibles. El Indravajra es un rayo de luz ardiente, un rayo "láser" que es dirigido y disparado a través de un escudo circular que actúa como una especie de reflector.

Por último, el Narayanastra, Pashupatastra y, sobre todo la Brahmastra son tan letales que extinguen toda la vida en el área en que son desatados y causan daños a largo plazo y fatales para el ecosistema.

No es necesario señalar que muchas de las características y los efectos de las míticas armas son muy similares a las capacidades de las armas químicas, balísticas, meteorológicas, electromagnéticas y nucleares que han sido desarrolladas por las potencias militares más avanzadas, o son visualizadas por planificadores y científicos estratégicos para el futuro.

Aunque la respuesta típica de los académicos es que tales descripciones se limitan a reflejar la gran imaginación de los antiguos bardos, la abundancia de alusiones misteriosamente técnicas parece indicar la transmisión de un conocimiento empírico muy antiguo.

Por ejemplo, en [el Mahabharata](#), Krishna, cuando su oponente Saubha se hace invisible en el campo de batalla, le dispara a él una flecha o un misil guiado por sonido a alcanzar su objetivo.

Los [Vimanas](#) son de muchos tipos y son descritos a lo largo de un largo y rico período de la literatura hindú antigua y medieval. En el Mahabharata sus constructores se dice que son los yavanas, un pueblo del oeste que ha sido identificado con los griegos por muchas fuentes más tarde, pero que probablemente se refiere a una gran familia de occidental indoeuropea de naciones o tribus.

Sin embargo, la religión minorista del jainismo, que es extremadamente antigua, y ha grabado que algunos de sus guías iluminados (Tirthankaras) vinieron al mundo en Vimanas jayanta.

En textos posteriores algunas veinticinco formas de Vimanas de diversos tamaños, desde el pequeño al

gigantesco (ciudades celestiales) son descritas en algunos detalles bastante grandes. En el lenguaje de la arquitectura, un Vimana es una torre o un edificio que tiene siete pisos y es el nombre específico de la aguja que se levanta por encima del santuario (garbhagriha: casa del huevo o germen) de un templo.

Más recientes [tratados sánscritos](#) como el Visnudharmottaram, el Aparajitaprachcha, el Abhilasirtharta Chintamani y el Narada y Kasyapa Silpa Sastras contienen información sobre los detalles de la construcción y el funcionamiento de Vimanas.

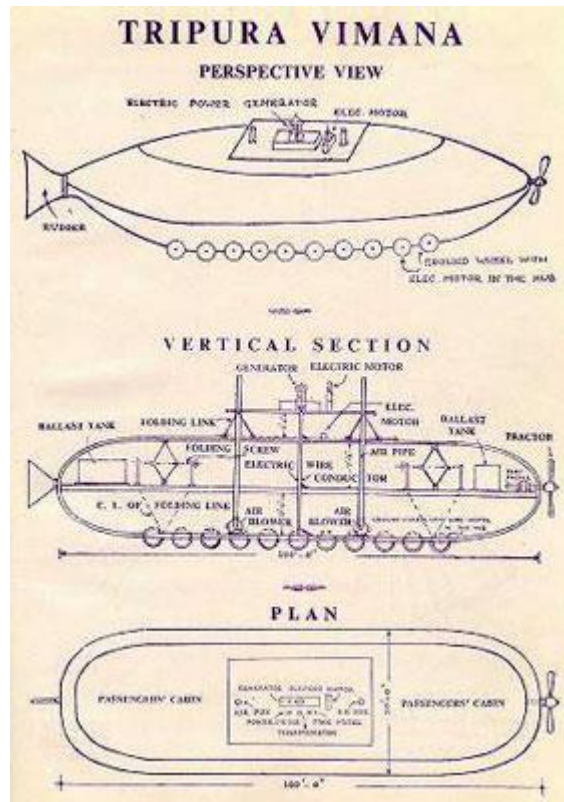

La fuente más conocida, la [Samarangana Sutradhara](#), atribuida al rey Bhoja de Dhara del siglo 11 y su inmensa academia científica y literaria tiene lo siguiente que decir sobre esos vehículos espaciales:

"Fuerte y durable debe ser hecho el cuerpo de la Vimana, como un gran pájaro de vuelo, de material ligero.

En el interior hay que poner el motor de mercurio con su caliente aparato de hierro por debajo. Por medio del poder latente en el mercurio, el cual establece el torbellino de conducción en marcha, un hombre sentado en el interior puede viajar una gran distancia en el cielo.

Los movimientos de un Vimana son tales que puede ascender verticalmente, ascender y descender verticalmente o moverse hacia delante o hacia atrás. Con la ayuda de las máquinas, los seres humanos pueden volar por el aire y los seres celestiales pueden venir a la tierra". (Capítulo 1, 95-100)

El mismo texto describe robots bio-mecánicos usados como guardias y soldados. (ibid., 101-107)

De lo anterior podemos concluir que la literatura hindú sagrada, histórica y técnica sabe de muchos diversos mundos y dimensiones y de varios tipos de seres que se mueven generalmente de ida y vuelta entre esas dimensiones, al igual que nosotros probablemente lo hacemos inconscientemente.

La antigua India también mantuvo la memoria - tal vez refrescada por ocasionales o frecuentes observaciones - o de naves espaciales construidas artificialmente impulsadas por energía psíquica o mecánica, y capaces de moverse en el aire, como también sobre y debajo del agua.

Ahora podemos hacer una rápida revisión de los reportes relativamente recientes y contemporáneos que concuerdan con las leyendas hindús, anales y crónicas, y así dar razones para creer que estos antiguos relatos

están basados en experiencia real o por lo menos en evidencia visual.

## Registros Modernos y Observaciones

Incluso si nos abstenemos de remontarnos al siglo 19, o incluso a tiempos aún más antiguos, en donde existen algunos reportes (e incluso algunas cuantas fotografías antiguas) de aeronaves desconocidas con criaturas "no humanas" que descendieron del cielo, pero para lo cual se pudiera carecer de evidencia dura, hay que recordar que algunas declaraciones importantes, realizadas por importantes figuras de la ciencia y por líderes militares, indican, más allá de toda duda razonable, que el conocimiento de "seres superiores" ha existido por más de un siglo entre la élite tecnocrática de nuestras sociedades.

Parece que por alguna razón poco clara, un súper-humano, no- terrenal, o al menos una presencia no- terrenal se le manifestó en un número de personas en Europa y América poco después de la Primera Guerra Mundial.

Como si esa gran crisis de la civilización, que marcó el final de una época, hubiera provocado un gran interés "desde arriba". Avistamientos de OVNI's, e incluso aterrizajes fueron reportados en los Estados Unidos y en Alemania y se formaron algunas sociedades secretas, supuestamente bajo la guía de seres de otros mundos.

Los más influyentes fueron los rumores de sociedades que, nunca fueron históricamente establecidas, como Sol Negro y Sociedad Vril en Baviera y en el ahora bien conocido [Grupo Thule](#).

La [Sociedad Vril](#), nombrada en honor a la energía cósmica de la vida, que es equivalente a Prana en sánscrito, se inspiró en un joven y hermosa médium, María Orsic, que afirmaba estar en contacto con un grupo muy avanzado de seres de un planeta alrededor de la [gigantesca estrella de Aldebarán](#) (*Rohini* en astronomía en sánscrito) dentro de la constelación de Tauro.

Aquellos seres supuestamente le enviaban mensajes periódicos y por lo tanto transmitían información de alto nivel científico, diseñada para capacitar a los miembros del grupo para producir energía inagotable, no contaminante y construir aviones capaces de volar a una velocidad prácticamente ilimitada, con el fin de alcanzar las estrellas.

Los datos canalizados por María Orsic y otros "Vrileños" (jóvenes mujeres médiums) fueron interpretados por el profesor **W.Schumann**, de la Universidad Técnica de Munich y fueron utilizados para tratar de construir los "platillos voladores", a partir de un primer prototipo probado sin éxito, ya en 1922, sobre un lago de Baviera.

El programa fue llevado adelante más adelante por el Tercer Reich, bajo la supervisión de su División SS E-IV, ya que algunos miembros de los grupos Vril y Thule (cerrados por la Gestapo, como la mayoría de otras sociedades secretas) se convirtieron en funcionarios de alto rango del nuevo régimen.

A pesar de una gran controversia rodeando la extensión y la tasa de éxito del programa de construcción de [naves "Haunebu" y "Vril"](#), no hay duda de que los alemanes experimentaron a lo largo de los años de guerra tecnologías giroscópicas y turborreactores de "discos voladores" - a la par de las tecnologías más convencionales de cohetes V1 y V2, construidos por **Willy Ley** y **Wernher von Braun** - a través de este tipo de embarcaciones como el RFZ-1, probada por primera vez en 1934, y la posterior y superior RFZ-2 se cree que alcanzaron impresionantes niveles de rendimiento.



El general **Hans Kammler** de las SS, quien organizó el uso de mano de obra prisionera de los campos de concentración para el programa de armamento espacial dirigido por el general Dornberger, supuestamente supervisó el esfuerzo de la R&D en propulsión anti-gravedad.

Es significativo que la tecnología de propulsión se dice que consistía básicamente en el montaje de "[Tachyonadores Thule](#)", esferas de mercurio rotando verticalmente, en concordancia con lo que algunos de los Shastras hindúes describen en los Vimanas.

Como dice el profesor **Hermann Oberth**, uno de los padres de los programas espaciales alemanes y estadounidenses más tarde, y el mentor principal de von Braun, lo resumió sucintamente que fueron ayudados por "gente de otros mundos".

En paralelo con el esfuerzo de investigación alemán, hay pruebas documentales de que Benito Mussolini fue informado por sus funcionarios en la caída o el aterrizaje de un OVNI (un *aeromóvil sconosciuto*: aeronave desconocida) en la provincia de Veneto de Italia a finales de 1932 y ordenó personalmente, en sus propias instrucciones telegráficas que fuera destruido a "plomo fundido", así como que fuera mantenido un "silencio total", instruyendo, además, a los medios estatales que describieran el objeto como un meteorito en sus publicaciones.

La evidencia de esto se presenta en forma de facsímiles de los telegramas del dictador reproducidos en el libro "Contattismi di Massa" (2005) de Stefano Breccia (publicado en Inglés como "Contactos masivos" - Authorhouse, 2009).

Mussolini - que poco después creó la Unidad de Investigación RS/33 dedicada a nuevas tecnologías, con la participación de Guglielmo Marconi, el inventor de la radio - resultaría ser uno de muchos estadistas confrontados a evidencia material de este tipo, y, como casi todos los demás, lo trató como un asunto de alto secreto de seguridad nacional.

Una alusión semi-irónica al descubrimiento clandestino puede ser detectada en el famoso discurso del Duce a la Federación de Sindicatos Fascistas en el Teatro Adriano en Roma el, 23 de febrero<sup>a</sup> de 1941, en el que dijo:  
"En cualquier caso, es más plausible que los Estados Unidos (fueran) invadidos, en vez de por las tropas del Eje, por los habitantes del planeta Marte, no tan conocidos, pero parecen más bien guerreros que han de venir desde el espacio sideral en inimaginables fortalezas volantes".

La investigación alemana de balística y asuntos relacionados con el espacio, obviamente, de sumo interés para los principales vencedores de la guerra, los Estados Unidos, la Unión Soviética y Gran Bretaña, hicieron grandes esfuerzos para identificar y "limpiar" la evidencia y el equipo que encontraron cuando invadieron el país.

Los programas espaciales estadounidenses y soviéticos se puede decir que surgieron de las cenizas de los logros y planes del Tercer Reich para ganar el dominio del espacio aéreo y de salir de la atmósfera.

Los escépticos han argumentado que Vril es el nombre de una fuerza cósmica psico-física descrita por primera vez en el 1871 en la novela "Vril - El Poder De La Raza Viene - [Vril - The Power of the Coming Race](#)" del escritor británico y ocultista Lord **Bulwer Lytton**, el famoso autor de los últimos días de Pompeya, y que, por ser un nombre ficticio, difícilmente podría haber sido adoptado como un símbolo y una meta por una sociedad alemana oculta de investigación.

Sin embargo hay que señalar que Vril, la energía esencial en luz, sonido y electromagnetismo, que Bulwer Lytton asocia con una raza de gigantes de origen indo-ario, viven en una red de profundas cavernas subterráneas y están dotados de "conocimiento Enoquiano", fueron considerados como reales por eminentes estudiosos de la época, por no hablar de otros ocultistas como **Helena P. Blavatsky** y sus colegas teósofos.

Por un lado, el indólogo **Louis Jacolliot** quien se desempeñó como cónsul de Francia en Calcuta, en la segunda mitad de siglo 19, mencionó el Vril como el poder invisible aprovechado por los jainistas iniciados que conoció en Gujarat y en Mysore y que describió en su libro Tradiciones de los indo-europeos (1876), demostrando que el nombre fue utilizado en un contexto de no-ficción para dar cuenta de fenómenos reales.

Otra referencia a los Vril en un contexto de la India se encuentra en los escritos de Saint Yves d'Alveydre y yo personalmente he escuchado los testimonios de al menos dos personas, que anteriormente no sabían nada sobre la literatura anteriormente mencionada, que había escuchado de sus familiares durante la Segunda Guerra Mundial sobre las armas secretas estaban siendo desarrolladas por los dirigentes alemanes y hechas posibles por el descubrimiento de la energía Vril.

Tales relatos de la época muestran al menos que las historias se habían extendido en la sociedad civil alemana e italiana y puede haber habido un poco de fuego detrás de ese humo.

## El Enigma Polar

La conexión alemana con una "potencia alienígena" durante la Segunda Guerra Mundial sigue siendo un asunto de coyuntura y especulación hasta que haya sido encontrada más documentación o se haga pública.

Una declaración enigmática fue pronunciada por el almirante del Reich **Doenitz** durante su juicio en Nuremberg, en el sentido de que el Reich había mantenido "una fortificación invisible en medio de los hielos eternos", interpretado por muchos como un indicio de un remanente de una base secreta de los nazis cerca [del Polo Sur](#).



En este sentido algunas interesantes pistas de eventos bien establecidos pueden ser recuperados.

A finales de 1946, apenas un año después del fin de la guerra, cuando "cohetes fantasmas" estaban siendo reportados por la OSS (la precursora de la CIA) en Suecia, el Secretario de Defensa de los Estados Unidos, **James Forrestal**, encargado de la *Operación Salto Alto* ([Operation High Jump](#)) en la Antártida, una gran

armada, consistiendo de dos grandes embarcaciones, naves de comando anfibio, el Mount Olympus estadounidense y el portaaviones estadounidense Philippine Sea, 13 buques de apoyo, dos hidroaviones, 15 otros aviones, helicópteros y otros 6 buques tripulados por 4.700 hombres y comandados por el pionero de la exploración polar, el almirante Richard Byrd.

La operación, sorprendentemente grande y bien armada para una misión "científica" en una zona deshabitada del mundo iba a durar hasta el otoño de 1947, pero fue bruscamente interrumpida a principios de marzo, luego de un encuentro con algo inesperado y bastante molesto.

Un reportado diario secreto del [Almirante Byrd](#), firmado 24 de diciembre de 1956 apareció varios años después de su fallecimiento, el 11 de marzo de 1957. Hasta el momento no hay confirmación alguna de su autenticidad, pero algunas de las declaraciones crípticas hechas por Byrd en su viaje de regreso de la Antártida, parecen prestarle cierta plausibilidad.

La entrevista de Byrd con el periodista Lee von Atta del INS (Nuevo Servicio Internacional) y publicada en el diario chileno El Mercurio el 5 de marzo de 1947 dice lo siguiente:

"El almirante Byrd advirtió hoy de la necesidad de los Estados Unidos de adoptar medidas de protección contra la posibilidad de una invasión del país por aviones enemigos procedentes de las regiones polares".

Sobre las razones para la terminación de la expedición de seis meses de anticipación, dijo:

"La más importante de las observaciones y descubrimientos realizados fue de la situación política actual en lo que respecta a la seguridad de los Estados Unidos" y pidió "al país permanecer en un estado de alerta y vigilancia. Estamos abandonando la región después de hacer importantes descubrimientos geográficos".

Teniendo en cuenta que los Estados Unidos era en ese momento la única potencia nuclear - la URSS daría una gran sorpresa en agosto de 1949 detonando su propia bomba atómica - y el ganador absoluto del conflicto mundial reciente, mientras que la mayor parte del mundo, incluyendo Europa Occidental, China, Japón y la URSS, estaban en ruinas y estaban todavía bajo dominio colonial u ocupación estadounidense, la advertencia dada por Byrd no es fácil de explicar.

La Unión Soviética se había convertido en el nuevo enemigo, pero Estados Unidos no podía temer la posibilidad que oleadas de bombarderos del Ejército Rojo fueran todo el camino hasta el Polo Sur en su camino a América del Norte, y el Pentágono tenía medios suficientes para rechazar cualquier ataque aéreo "bolchevique".

Con toda probabilidad, Byrd se refería a un claro y presente peligro que no era soviético, y que no podía identificar públicamente.

Si aceptamos su diario secreto como genuino, entonces debemos creer que, de acuerdo con sus propias palabras, mientras volaba sobre la Antártida desde el campo base "Pequeña America IV" en la bahía de las Ballenas, por el 2 de febrero de 1947., él fue "interceptado" y escoltado por "una nave en forma de disco" que lo llevó a una extensa instalación subterránea llamada "el dominio de Arionni" donde se reunió con el líder de un misterioso grupo de hombres de apariencia escandinava, que hablaba inglés con acento alemán y que le advirtieron sobre las pruebas a las que sería enfrentada la humanidad en las próximas décadas.

Byrd registra, además, en su diario, que a su regreso a los Estados Unidos, presentó su cuenta secreta a Forrestal y fue interrogado en el Pentágono durante seis horas y media, el 11 de marzo de 1947.

## Una Presencia en Aumento

Ese mismo año que vio la independencia de la India y Pakistán, la creación de Israel y de varios otros acontecimientos internacionales importantes, fue especialmente agitada en el frente "alienígena".

Es bien sabido que en junio de ese año, tres meses después del regreso de Byrd, muchos periódicos estadounidenses llevaron el reporte del aviador [Kenneth Arnold](#) sobre el avistamiento de un escuadrón de "alas voladoras" en forma de media luna deslizándose silenciosamente "como un platillo" en el aire, sobre el Estado de Washington a 1200 millas náuticas por hora.

Él era un testigo y un experto de alta credibilidad, de manera que su testimonio era incuestionable, que no



existía aún ninguna una política oficial para negar los reportes de OVNI



Entre el 4 y el 6 de julio, una o varias embarcaciones, al parecer en forma de medialuna, también [se estrellaron o fueron derribadas en el desierto de Nuevo México, cerca de Roswell](#) en el área general de los Alamos, Arenas blancas y Alamo Gordo (el centro neurálgico del Proyecto Manhattan, todavía en curso), según anunció el portavoz del ejército local, en los periódicos y en la radio, lo que provocó una oleada de actividad en el Gobierno de los Estados Unidos, que rápidamente ordenó a las autoridades militares correspondientes a la edición y tiraje se retractaran por Orden Ejecutiva y apresuraron el paso de la draconiana y secreta Ley Nacional de Seguridad en el otoño de ese año.

Ya sea por coincidencia o no, el diario Forrestal de 3,000 tirajes diarios se saltó completamente el periodo comprendido entre el 03 de julio y el 14. Posteriormente, las alertas y accidentes OVNI fueron "bloqueados", y tratados con la misma mezcla de estricta alarma y censura apenas disimulada.

En septiembre, el Comando Aéreo Estratégico envió un ala de bombarderos B-29 en una misión para el Ártico, basándolas en Fort Richardson, Alaska, posiblemente en respuesta a la advertencia de precaución del Almirante Byrd sobre el peligro de ataque desde los polos. Al igual que los registros de la operación Salto Alto, las metas y los resultados de esa misión fueron clasificados (hechos secretos).

Menos de dos años más tarde, las circunstancias de crisis mental de Forrestal y su posterior muerte por suicidio en circunstancias que nunca fueron debidamente investigadas, mientras estaba bajo vigilancia de 24 horas en el Hospital Naval de Bethesda, prestaron apoyo a las teorías sobre un siniestro e importante secreto que pudo haber sido sospechado por el liderazgo de Estados Unidos durante la guerra y al menos en parte descubierto por Byrd durante El Salto De Altura La Misión de la Antártida .

Ese secreto ha sido desde entonces mantenido por determinadas personas y agencias en el gobierno de los Estados Unidos, si juzgamos por la cantidad de indicios disponibles en los registros públicos.

Fue establecido por sus biógrafos que el ex secretario de Defensa estaba bajo fuerte estrés el 28 marzo de 1949, cuando el presidente Truman le hizo presentar su dimisión, momento en el cual el Secretario de la Fuerza Aérea, Stuart Symington le dijo algo en confianza que parece haberlo empujado "por el borde".

Al día siguiente, Forrestal fue trasladado a la casa del futuro secretario de Defensa, **Robert Lovett** en la Florida, bajo supervisión militar, y colocado bajo el cuidado de un psiquiatra naval, quien en gran medida lo medicó, y luego lo ingresó en Bethesda el 2 de abril, como paciente interno. Su diario fue trasladado a la Casa Blanca por orden de Truman.

Richard Dolan, en su capítulo detallado sobre la muerte de Forrestal incluyó en su libro "[OVNIS y el Estado de seguridad Nacional - Parte I - UFOs and The National Security State - Part I](#)", señala que a muy poca gente se le permitió reunirse con él (su hermano Enrique tuvo que pedirlo varias veces antes de poder visitarle) y que incluso sus propios confesores religiosos fueron inexplicablemente mantenidos fuera de la Armada por los cuidadores de la Naval que supervisaban su cuidado (Forrestal fue un católico romano practicante).

Por otro lado, Truman, su sucesor en el Departamento de Defensa, **Louis Johnson**, su viejo enemigo Stuart

Symington y algunos otros altos funcionarios gubernamentales le llamaban, aunque él no había pedido verlos. Truman estaba obviamente preocupado por cualquier documento descubierto o grabaciones que pudieran haber sido guardadas por sus antiguos miembros del gabinete, y en agosto de 1949, Louis Johnson le envió un memorando confidencial asegurándole que no habían grabaciones de voz ni ningún otro documento relativo a la conversación que Truman mantuvo con Forrestal .

Efectivamente, Forrestal se había convertido en un prisionero de la Marina de los Estados Unidos. Parece que la preocupación del gobierno era evitar revelaciones del antiguo miembro del gabinete que terminó con su vida (o lo hicieron hacerlo) el 22 de mayo de 1949, la noche antes que su hermano lo llevara a casa después de su aparente recuperación.

Incidentalmente, uno de los primos del Secretario de la Fuerza Aérea, Stuart Symington, quien no es otro que **Fife Symington** que, mientras fue gobernador de Arizona, el 13 de marzo de 1997, fue uno de los miles de desconcertados testigos de las espectaculares "Luces de Phoenix", descritas como el paso de una silenciosa nave de 2000 a 3000 pies de ancho, en forma de delta negro mate luciendo una fila de deslumbrantes luces sobre la ciudad.

Después de intentar ridiculizar el avistamiento en una conferencia de prensa, hizo que uno de su personal portara una máscara de un "alienígena gris", Symington años más tarde, cuando ya estaba fuera de servicio se disculpó y reconoció rápidamente ante las cámaras en el Club Nacional de Prensa de Washington DC que lo que había visto era, de hecho, "alguna forma de nave extraterrestre".

El "factor ET" parece operar a través de generaciones para algunas familias.

Por supuesto, hay muchos asuntos en los que Forrestal debe haber tenido información muy privilegiada que podría haber causado angustia a Truman si hubiera hablado, pero una intrigante pista fue proporcionada por el general **Arthur Exon**, el ex oficial jefe de la Base Aérea de Wright Patterson (el sitio del Comando de Material Aéreo) en 1990, cuando declaró que Stuart Symington había sido miembro de los "Unholy 13" que controlaban las políticas sobre los asuntos relacionados con OVNIs en el Gobierno.

Ese grupo es casi seguro que es el "ultra-secreto" [MJ-12 o Comité Majestic](#), según se informa, nombrado por Truman y por Forrestal para manejar la situación de los alienígenas, en el que Forrestal estaba.

Una colección exhaustiva de sólidos y confirmados reportes de avistamientos y encuentros alienígenas compilado desde 1947 hasta nuestros días podría llenar muchos libros (que ya se han escrito), y por lo tanto sólo podemos mencionar brevemente algunos de los registros más incuestionables.

Es importante señalar, como ya hemos señalado antes, que desde la segunda mitad de la Segunda Guerra Mundial, los Estados Unidos se habían embarcado, no sólo en el máximo secreto, el exorbitantemente caro Proyecto Manhattan (sólo el Laboratorio de Oak Ridge consume una sexta parte de toda la energía eléctrica producida en el país durante los años de guerra), sino también de un elaborado programa para ganar la posesión de toda la investigación avanzada y la tecnología a ser encontrada en el Tercer Reich, a través de la JIOA (Agencia de Inteligencia Conjunta de Objetivos).

Cientos de científicos e ingenieros "nazi" fueron identificados y seleccionados para traslado a los Estados Unidos en la creencia de que podían aportar una contribución inestimable a la máquina de guerra de Estados Unidos, así como a la economía civil.

No menos de 86 ingenieros aeronáuticos y 127 científicos de cohetes, entre ellos **von Braun**, y su jefe **Dornberger**, fueron el blanco de la operación Lusty (tecnología secreta de la Fuerza Aérea Alemana - Luftwaffe) de un total de unos 1.600 hombres. A partir de 1945, la mayoría fueron traídos a los Estados Unidos después de ser detenidos secretamente, a menudo en violación de la Convención de Ginebra, ya la Cruz Roja fue mantenida en la oscuridad acerca de su ubicación.

Además, con el fin de eludir una legislación de Estados Unidos prohibiendo el asilo a aquellos relacionados directamente con el régimen nazi, quienes podrían ser responsables de crímenes de guerra, fueron provistos por la OSS con documentos falsos.

La operación de alta prioridad, conocida primero como Overcast-Cubierto y más tarde como [Paperclip](#) refleja la hipocresía o por lo menos la ambigüedad moral del todopoderoso complejo militar, que ignoró las leyes nacionales e internacionales con el fin de lograr sus objetivos, siguiendo los pasos del Proyecto Manhattan, coordinado por el Dr. **Vannevar Bush**, fundador y jefe de la secreta *Oficina de Investigación Científica y*

Desarrollo ([OSRD](#)).

También se cree que Bush creó y dirigió el MJ-12, que, de acuerdo a la correspondencia clasificada de ese tiempo se mantuvo en un nivel secreto más alto que aquel de su ahora famoso predecesor fabricante de la bomba atómica.

La Operación Lusty adquirió y almacenó en su sede el Comando de Material Aéreo en Wright Field, Ohio (más tarde Base de la Fuerza Aérea de Wright Patterson) más de 16.000 artículos, con un peso de 6.200 toneladas, de las listas negras de "equipos extranjeros" de las potencias del Eje, en su mayoría relacionadas con aeronáutica y balística. Dado que aún no había una Fuerza Aérea Independiente de Estados Unidos en esos momentos, la autoridad supervisora era el "Escritorio del Ejército de Información de Tecnología Extranjera" en el Pentágono.

El fallecido coronel [Philip J Corso](#), un oficial de alto nivel de inteligencia militar, ha afirmado en sus memorias que dicho servicio también recibió y mantuvo una "tecnología extraterrestre" recuperada a bordo de los discos voladores capturados.

No hay escapatoria a la conclusión de que unos Estados Unidos hegemónicos, pero paranoicos, como consecuencia de la mayor guerra del siglo 20, rápidamente se preparaban para una nueva confrontación, no sólo con el poder comunista en Rusia y en China, sino también con una agencia aparentemente no-humana de fuera de este mundo, que en primer lugar se creyó que tenían su origen en o por debajo de los polos, que es definida como una secreta, pero importante amenaza.

El presidente Truman, ampliamente informado sobre los avistamientos de OVNI y encuentros con su oficial de enlace militar, el coronel **Robert Landry**, que, al igual que todos los funcionarios que lo conocen, han estado desconcertados por las frecuentes visitas de la "desconocida aeronave inteligente" a las instalaciones estratégicas más sensibles y restringidas del país, incluyendo las instalaciones Arenas Blancas y Alamo Gordo.

Enfrentado al Cuerpo de Prensa de la Casa Blanca el 4 de abril de 1950:

"Les puedo asegurar que los platillos voladores, dado que existen no son construídos por ningún poder en la Tierra".

Los años siguientes habrían de ser testigos de miles de avistamientos y varios espectaculares vuelos de OVNI de muchas de las capitales del mundo, [especialmente sobre Washington DC](#), así como también sobre las bases de la Fuerza Aérea y las centrales nucleares de los Estados Unidos y de las otras grandes potencias.



En 1952, poco después de los masivos sobrevuelos sobre la Casa Blanca y el Pentágono por los OVNIs, el 19 de enero, el Presidente hizo que el General **Hoyt Vandenberg Sanford**, el Jefe de la Fuerza Aérea dijera que había sido confirmado que no eran ni rusos ni americanos, y que el gobierno no conocía su identidad u origen.

Sin embargo Vandenberg, un ex director de la CIA, había sido directamente asociado con el manejo oficial del incidente de Roswell en 1947, y está considerado como un miembro del Majestic 12.

En 1948, había en parte descartado, sin dar sus razones, pero aparentemente por razones de seguridad nacional, la "estimación de la situación", agregado a su propio reporte del personal de USAF [Proyecto Sign](#) sobre los OVNIs, a favor de un origen extraterrestre. El reporte fue posteriormente quemado por orden suya en 1950. La evidencia de un intento de encubrimiento parece abrumadora.

Vale la pena señalar que los documentos personales del General se guardan en los Archivos Nacionales, donde están clasificados (inaccesibles para el público). De este modo podría decirse que sabía más de lo que públicamente declaró en 1952 sobre la naturaleza de los vehículos voladores que habían sobrevolado la capital federal.

Otros oficiales superiores fueron más abiertos, como fue demostrado por el general George Ramey, subjefe de personal de la Fuerza Aérea para operaciones, el 29 de julio de 1952, cuando dio una conferencia de prensa en la que, de acuerdo con el periódico El Examinador de San Francisco, dijo lo siguiente: Que aviones de propulsión habían sido colocados en 24 horas de alerta a nivel nacional contra los platillos voladores, con órdenes de derribarlos si se negaban a aterrizar.

Según el reportero Robert Gardner, el general **Benjamin Childlaw**, GOC, del Comando de Defensa Aérea en febrero de 1953 le dijo de manera significativa:

Las tomamos en serio (los platillos volantes) si tenemos en cuenta que hemos perdido muchos hombres y aviones tratando de interceptarlos.

En Europa y en el otro lado de la cortina de hierro, oficiales militares de alto rango de la Unión Soviética estaban haciendo comentarios similares, aunque por lo general fueron censurados o minimizados en los medios de comunicación estatales.

Rumores apoyados por fuentes "internas" creíbles se extendieron acerca del Presidente [Eisenhower](#) [reuniéndose en dos ocasiones con visitantes alienígenas](#) de apariencia "nórdica a bordo de su nave espacial en

dos bases de Fuerzas Aéreas en 1954, pero si eso pasó o no, no podemos ignorar el revelador anuncio de Wernher von Braun en 1959:

"Nos encontramos frente a poderes que son mucho más fuertes de lo que hasta ahora suponíamos, y cuya base es actualmente desconocida para nosotros. Más no puedo decir actualmente. Estamos empeñados en entrar en contacto más estrecho con estos poderes, y dentro de seis o nueve meses, puede ser posible hablar con más precisión sobre el asunto".  
(Citado en Más Arriba de lo Ultra Secreto, por Timothy Good, 1988)

Von Braun parece haberse acercado al misterio OVNI con una mente abierta y una disposición más bien optimista, pero esa no era la mentalidad de los generales y funcionarios civiles que dirigían el Pentágono y las agencias de inteligencia.

Ellos, obviamente, veían enemigos potenciales en los visitantes desconocidos y llamaron a la movilización mental y técnica a los más altos nivel del gobierno en contra de lo que percibían como una formidable amenaza.

Declaraciones en el registro, de los principales hombres de uniforme, tales como **Nathan Twining, Childlaw Benjamin y Douglas MacArthur** dan fe de ello.

Este último emitió una severa advertencia a la clase graduanda de 1962, el 12 de mayo en la Academia de West Point, posiblemente dejando escapar más de lo que sus compañeros deseaban, cuando habló del, "Conflicto final entre una raza humana unida y fuerzas siniestras de otra galaxia planetaria".

Ya entonces, quizás desde el momento de la transmisión de Orson Welles de la invasión de Marte en octubre de 1938, el fenómeno OVNI-ET se había convertido en parte de la cultura popular a través de innumerables libros, programas de radio, películas y series de televisión.

La información se había extendido cada vez más extensamente, a pesar de que estar rodeada de una cantidad igualmente grande de desinformación, generando un clima de confusión general.

En años recientes, los documentos clasificados de los gobiernos de varios países, incluyendo los Ministerios de Defensa de Gran Bretaña, Francia, Brasil, Perú y México, de una sola vez proporcionaron evidencia de la existencia de seres extraterrestres piloteando naves voladoras muy avanzadas y aterrizando en la tierra.

Uno de los reportes publicados por el Ministerio de Defensa del Reino Unido en julio de 2010 indica que el primer ministro Winston Churchill había acordado con el general Eisenhower encubrir los encuentros cercanos entre aviones militares y los OVNI durante la guerra, en aras de la seguridad nacional y estabilidad social. Es revelador que Churchill estaba preocupado de que la religión podría ser fatalmente dañada como resultado de la divulgación pública de los incidentes.

Sin embargo, al lado de los avances tecnológicos y desarrollos militares conectados con la reacción oficial ante el fenómeno OVNI, se produjo un efecto espiritual, menos visible. El General Dornberger ocupaba un alto cargo en la Corporación Bell Aerospace, en la que estaba asociado con Arthur M. Young, el visionario ingeniero e inventor que fundó el Instituto para el Estudio de la Conciencia.

Young y el investigador [Andrija Puharich](#) eran ambos miembros de la Fundación de la Mesa Redonda, en Glen Cove, Maine, que actuaba como un "canal" para una serie de mensajes supuestamente enviados por una asamblea de autoridades extra-terrestres designadas como [el Consejo de los Nueve](#), a través de un médium visitante de la India, el respetado maestro espiritual y clarividente de la India Maharshi **Nyayaratna DG Vinod** de Mumbai, conocido por muchos de las figuras líderes de la India en el tiempo de la Independencia, incluyendo a Mahatma Gandhi, Sri Aurobindo y Rabindranath Tagore y quien había sido invitado a los Estados Unidos por la Universidad de Duke.

Se dicen que Los Nueve inspiraron a Gene Roddenberry a crear su inmensamente exitosa serie de televisión Star Trek.

Vinod alcanzó gran fama en el mundo de la investigación ESP como conferencista y colaboró con varias universidades e institutos especializados en los Estados Unidos (como el centro de la investigación parapsicológica Dr. Pfeiffer en Spring Valley, Nueva York) y Europa. Se reunió con figuras de la talla de Jung, Aldous Huxley, Eistein y Millikan.

La Fundación Mesa Redonda fue apoyada por el prestigioso Instituto de Investigación Stanford (SRI), cuyo director era entonces el Dr. [Harold Puthoff](#), un pionero en estudios para-normales relacionados con OVNI.

Una organización relacionada fue el Instituto Jason que se centró en asuntos relacionados con defensa, y por ello estaba relacionada a la CIA, cuyos diversos, y por lo general infames programas para investigar y poner a prueba el potencial para la guerra de la mente, relacionada con operaciones clandestinas, tales como [MK Ultra](#) y Artichoke, guardan relación con la observación y la investigación de los OVNI, como lo reconoce el conocido investigador **H.P. Albarelli**, miembro fundador de *La Verdad en América del Norte y la Comisión de Responsabilidad* en la experimentación humana y autor de *Un Terrible Error: el asesinato de Frank Olson y los Secretos Experimentos de la Guerra Fría de la CIA* (2010), aunque la naturaleza exacta de la relación es a menudo difícil de evaluar.

Parece que hay una forma de cooperación entre algunos "Alienígenas" y aquellas agencias de los Estados Unidos, a menos que estos últimos esté simplemente tratando de utilizar la información que obtienen de esos seres.

Pistas similares se pueden obtener de otros gobiernos en un momento u otro. Por ejemplo, el Presidente de la República rusa budista de Kalmykia, **Kirsan Ilyumzhinov** declaró en 2010, en un programa de prime time en la televisión rusa que había sido secuestrado en 1997 en su casa de Moscú por "alienígenas amarillos vestidos de cosmonautas" a bordo de una nave espacial y le dijeron que "no estaban listos" para interactuar públicamente con la humanidad.

Esta declaración provocó una carta oficial de un diputado de la Duma, el Parlamento ruso, el presidente **Dimitri Medvedev** buscando una aclaración sobre el significado de este testimonio y sus implicaciones para la seguridad nacional.

Sin embargo ninguna hay respuesta del jefe de Estado ruso parece haber llegado hasta el momento, y su silencio pudiera ser una evidencia más del profundo dilema en el que muchos estados se encuentran.

En 2009, la esposa del entonces Primer Ministro japonés Hatoyama reiteró a los medios de comunicación que había sido "llevada a Venus" en un OVNI.

## Mensajes Codificados

Uno de los fenómenos más desconcertantes pero espiritual y estéticamente agradables es generalmente, considerado como un corolario de la presencia de OVNI es la frecuente aparición de los "[círculos en los cultivos](#)" en varias partes del mundo, pero más a menudo en Inglaterra.

La extraordinaria complejidad de esos patrones geométricos, cuyas formas y diseños muy parecidos a los yantras y mandalas indios denota no sólo una tecnología desconocida y muy sofisticada - al parecer utilizando haces de microondas - para producirlos, por lo general en la oscuridad de la noche y en cuestión de segundos, sin ningún agente visible estando presente (a excepción de algunas luces moviéndose rápidamente que desaparecen tan repentinamente como se manifiestan), sino también una profunda familiaridad con la geometría sagrada del mundo antiguo y con las matemáticas avanzadas y las leyes biofísicas.

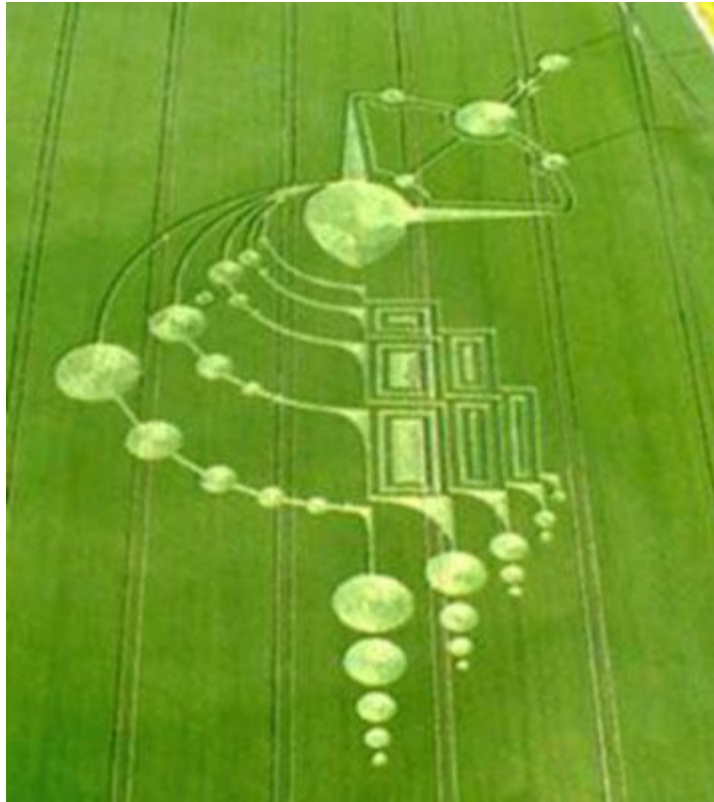

Ha sido demostrado por varios eruditos en el tema que los "círculos", a veces contienen elaboradas formulaciones científicas y revelan nuevas ecuaciones y leyes físicas.

Los intentos de los escépticos profesionales para "desacreditar" el misterio consiguiendo bromistas para dibujar algunos de los patrones relativamente más crudos o simples de los campos, con la ayuda de cuerdas y otras herramientas primitivas, pertenecen a la política sistemática de negar por completo la realidad "para-normal", rechazando declaraciones por medio de endebles pseudo-explicaciones.

Ellos no cambian nada a la realidad del fenómeno de los círculos de cosechas, y sin importar que muchas personas no estén familiarizadas con los hechos, han sido llevadas a creer.

Fotografías de la NASA tomadas en el espacio exterior han sido interpretadas por algunos expertos de mostrar algunos de los gigantescos objetos artificiales que parecen ser "naves espaciales masiva" aludidas, por el astrofísico **Stephen Hawking** en un reciente documental de televisión sobre cosmología y ciudades volantes y lokas celestiales descritas en algunos los antiguos textos indios.

Aún más sorprendentes son algunas imágenes genuinas, sin retoques ni correcciones con Photoshop mostrando OVNIs, a veces de un tamaño muy grande, como casi invisibles o transparentes, como si se movieran en la periferia de nuestro universo físico o por lo menos en el borde de la percepción electromagnética. Por lo tanto, parecen pertenecer a otras dimensiones a menudo descritas en los textos antiguos, así como también por gigantescas contemporáneos "ocultistas".

Por tanto, es mucho más fácil de entender por qué esa faceta de la realidad ha sido generalmente descartada o ignorada por las investigaciones científicas de la corriente principal.

Vamos a dar la última palabra al eminente psicoanalista **Carl Gustav Jung**, que hizo considerables investigaciones sobre el tema de los OVNIs y que llegó a la conclusión:

Sigue siendo un hecho establecido, apoyado por numerosas observaciones, que los OVNIs no sólo han sido vistos visualmente sino que también han sido recogidos en la pantalla del radar y han dejado huellas en la placa fotográfica.

Todo se reduce a nada menos que esto: que, o bien proyecciones psíquicas devuelven un eco de radar, o bien la aparición de objetos reales proporciona una oportunidad para proyecciones mitológicas".

[\(A Fresh Look at Flying Saucers, Time, August 4th, 1967 - Una nueva mirada a los platillos voladores, Time, 04 de agosto 1967\)](#)

Entonces, ¿estará llegando desde el remoto pasado a la mayoría de los continentes la mitología indígena y la historia antigua (Itihasa: "así fue"), entre otros, registrando una era en la cual los seres humanos reconocían la presencia de los dioses o los "resplandecientes", comunicándose desde varios "cielos" y dimensiones, e interactuando con ellos en muchos aspectos?

Si es así, nuestra moderna "visión científica del mundo" necesita una drástica revisión y corrección de la historia de nuestros orígenes, la cual pudiera ser muy diferente de lo que se enseña en las escuelas.

**Regresar a Los Vimanas**  
**Regresar a La Saga de Los Objetos**  
**Voladores**  
**Regresar a German Disc Aircrafts - 1922-**  
**1945 and Beyond**  
**Regresar a Temas / Las Traducciones de Adela**  
**Kaufmann**

## CHAPTER 32

### ADOLF SCHICKLGRUBER AND THE 'THULE-GESELLSCHAFT'

To throw some light on the mysterious "Third Reich" and the role of **Adolf Hitler** I have to go a bit further afield. All over the world Germans were – and since the last attacks on homes for people seeking political asylum still are – linked to the Third Reich. But very few know the actual motives from that time.

One hears about the "Aryan master race theory" and the "gassing of the Jews", but not one percent know about the origin of these. In their schoolbooks the German children are told of the evil Adolf Hitler who apparently, supported by aimed propaganda and mass hypnosis, was the only culprit of those events. They are not told from whom he took his ideology, who had put him into his position and, above all, who had financed him.

Actually, 95% of the financial support came from Jewish sources. Interesting, isn't it? The Allies had quite intentionally removed or forbidden all the books that could have uncovered this, and so today a dark mystic veil lies upon Germany's recent past. Therefore I consider it more than necessary to shed some light into this dark area, even if some theories will be thought by some to be outrageous. At least here you find the "right stuff" to discuss later.

Between 1880 and 1890 many personalities – among them some of England's most brilliant minds – found together and formed "THE HERMETIC ORDER OF THE GOLDEN DAWN" Its members come largely for the Mother Grand Lodge of FREEMASONS and the ROSICRUCIANS. In a way the **Golden Dawn** was leading esoteric Freemasonry (rather positive) in England and was its innermost and most secret circle.

Members are, among others:

- FLORENCE FARR; W.B. YEATS (Nobel prize for Literature)
- BRAM STOKER (author of Dracula)
- GUSTAV MEYRINK (author of The Golem and The Green Face)
- ALEISTER CROWLEY (perhaps the best know magician of the last hundred years who later got into black magic, founder of the Thelma Church and 33rd degree Freemason of the Scottish Rite)
- RUDOLF STEINER (founder of antroposophy, Freemason of the Scottish Rite, head of the German Theosophical Society, Grand Master of the Illuminati order ORDO TEMPLI ORIENTIS (OTO) and Grand Master of the branch MYSTERIA MYSTICA AETERNA, later left the "Golden Dawn" because of differing views).

Steiner refused to allow occultist Trebisch-Lincoln access to the "Golden Dawn", a decision which later was held against him.

In 1917 the occultist BARON RUDOLF VON SEBOTTENDORF, the Gurdjieff disciple KARL HAUSHOFER, the ace pilot LOTHAR WAIZ, PRELATE GERNOT of the secret "Societas Templi Marconi" (The Inheritors of the Knights Templar) and MARIA ORSIC, a transcendental medium from Zagreb, met in Vienna.

They all had extensively studied the Golden Dawn, its teachings, rituals and especially its knowledge about Asian secret lodges. Sebottendorf and Haushofer were experienced travelers of India and Tibet and much influenced by the



teachings and myths of those places. During the First World War, **Karl Haushofer** had made contacts with one of the most influential secret societies of Asia, the Tibetan “Yellow Hats” (**dGe-lugs-pa**).

This sect was formed in 1409 by the Buddhist reformer **Tsong-kha-pa**. Haushofer was initiated and swore to commit suicide should his mission fail. The contacts between Haushofer and the Yellow Hats led in the Twenties to the formation of Tibetan colonies in Germany.

The four young people hoped that during these meeting in Vienna they would learn something about the secret revelatory texts of the KNIGHTS TEMPLAR and also about the secret fraternity DIE HERREN VOM SCHWARZEN STEIN (“The Lords of the Black Stone”). Prelate Gernot was one of the “Inheritors of the Knights Templar”, which to my knowledge are the only true Templar society. They are the descendants of the Templars of 1307 who passed on their secrets from father to son – until today. Prelate Gernot apparently told them about the advent of a new age – the change-over from the Age of Pisces to the Age of Aquarius.

They discussed that our solar year – according to the twelve revolutions of the moon – was divided into twelve months and thus the revolution of our sun around the great central sun (the BLACK SUN of ancient myths) was also divided into twelve parts. Together with the precession of the cone-shaped proper movement of the Earth due to the inclination of the axis, this determines the length of the world age.

Such a “cosmic month” is then 2,155 years, the “cosmic year” 25,860 years long. According to the Templars the next change is not just an ordinary change of the age, but also the end of a cosmic year and the start of an absolutely new one. By completing the 25,860 years the Earth is changing from the age with the weakest (Pisces) to the age with the strongest radiation (Aquarius). Indo-Aryan definition calls this the end of the Kali Yuga, the age of sin.

All age changes have led to political, religious, social and also geological upheavals of great impact. The time of change-over from the old to the new age is called in Mesopotamian teachings the three “*double steps of Marduk*”, of 168 years duration, at the mid-point of which the ILU ray, the Divine Ray, is expected to reach Earth.

The Templars did careful calculations and concluded that February 4, 1962 was the date the ray would reach Earth. This gave the mid-point of the 168 years change-over and the years 1934 and 1990 as other important dates.

The main part of the discussions dealt with the background of a section of the New Testament, Matthew 21:34. For there *Jesus* addresses the JEWS:

“Therefore I tell you that the kingdom of *God* will be taken away from you and given to a people who will produce its fruit.”

The complete original text that is kept in the archives of the “Societas Templi Marcioni” says it even more clearly. But the point is: In that text *Jesus* actually names the “people”, He talks to Teutons serving in the Roman legion and He tells them that it is THEIR people that He had chosen. That was what **Sebottendorf** and his friends wanted to know for sure: That the Teutonic, i.e. the German people was commissioned to form the realm of light upon Earth – in the “Land of the Midnight Mountain” (Germany). The place where the ray would meet the Earth was given as the Untersberg near Salzburg.

At the end of September 1917 Sebottendorf met with members of the Lords of the Black Stone at the Untersberg to receive the power of the “Black-Purple Stone” after which the secret society was named.

The Lords of the Black Stone who formed out of the Marcionite Templar societies in 1221 and were led by Hubertus Koch had set as their aim the fight against evil and the building of *Christ's* realm of light. This dark power they were to fight had revealed himself in the so-called *Old Testament* through Moses and other medium as *God*, starting with the words by YHWH = JAHVEH = Jehovah to Abraham:

“I am *God* Almighty!”

In Hebrew:

“Ani ha El Shaddai”, translated: I am El Shaddai – the “outcast Archangel (Shaddai El) – Sheitan or Satan” (see the original translation of Genesis 17:1, e.g. in : The Bible, New International Version).

**Sebottendorf** clearly recognized: The Shaddai, the *God* of the Old Testament, is the destroyer, the antagonist of *God*. His followers therefore sought to destroy the Earth, Nature and humanity. And the followers were the believers in Mosaic Law, the Hebrews. (Remember the tenets of the Talmud!)

In the Gospel of John, 8:39-45, *Jesus* states this directly. There he addresses the Jews:

‘Abraham is our father’, they (the Jews) answered.

‘If you were Abraham’s children,’ said *Jesus*, ‘then you would do the things Abraham did. As it is, you

are determined to kill me, a man who has told you the truth that I heard from *God*. Abraham did not do such things. You are doing the things your own father does.'

'We are not illegitimate children,' they protested.

'The only Father we have is *God* Himself.'

*Jesus* said to them:

'If *God* were your Father, you would love me, for I came from *God* and now am here. I have not come on my own; but He sent me. Why is my language not clear to you? Because you are unable to hear what I say. You belong to your father, the devil, and you want to carry out your father's desire. He was a murderer from the beginning, not holding to the truth, for there is no truth in him. When he lies, he speaks his native language, for he is a liar and the father of lies. Yet because I tell the truth you do not believe me!'

Today still many people naively ask: But why then did **Hitler** go against the Jews? I hope that the last few lines have shown you. In the eyes of the THULE-GESELLSCHAFT, from which later emerged the DAP (German Worker's Party), the SS (Schutzstaffel), the Jewish people who had been charged by the Old Testament *God* JAHVEH to "raise havoc on Earth" were the reason why the world was always caught up in war and discord.

The Thule people knew about the Jewish banking systems, i.e., Rothschild and allies, and the Protocols of the Elders of Zion and felt it was their task to fight the Jewish people, but especially their banking and lodge system, in accordance with the *Revelation of Sahaja*, and to erect the realm of light upon Earth.

Author's Comment:

As you can see, these people were just as incapable to remedy the cause as their Lord *Jesus* had told them how – to change the world with love for creation, for oneself and for the neighbor (and that neighbor can also be of another race or religion). But they had relinquished self-responsibility and gave it to a GUILTY one, a SATAN. Their hatred made them so blind that they never realized that they used the same weapons as the purportedly satanic *God* Jahveh they wanted to fight. They should have known though that one cannot achieve peace by war.

A circle formed around BARON RUDOLF VON SEBOTTENDORF that via the "Teutonic Order" in 1918 in Bad Aibling became the "THULE-GESELLSCHAFT". The themes they tried to link to politics were scientific magic, astrology, occultism and Templar knowledge as well as Golden Dawn practices like Tantra, Yoga and Eastern meditation.

The **Thule-Gesellschaft** believed, following the revelation of Isais, in a Coming Savior (German: Heiland = the Holy One), the Third Sargon who would bring to Germany glory and a new Aryan culture.

**Dietrich Bronder** (*Before Hitler Came*) and **E.R. Carmin** (*Guru Hitler*) named the leading members as follows:

- Baron Rudolf von Sebottendorf, Grand Master of the Order
- Guido von List, Master of the Order
- Jorg Lanz von Liebenfels, Master of the Order
- Adolf Hitler, "Führer", German Chancellor, SS Superior
- Rudolf Hess, Vice Führer, and SS Obergruppenführer
- Herman Goering, Reichsmarschall and SS Obergruppenführer
- Heinrich Himmler, Reichsführer SS and Reichsminister
- Alfred Rosenberg, Reichsminister and NS-Reichsleiter
- Hans Franck, Dr. Dr. h.c., NS-Reichsleiter and Governor General of Poland
- Julius Streicher, SA-Obergruppenführer and Gauleiter of Franken
- Karl Haushofer, Prof. Dr., Major General ret.
- Gottfried Feder, Prof. Dr., Secretary of State ret.
- Dietrich Eckart, Editor in Chief of the Volkischer Beobachter
- Bernhard Stempfle, father confessor and confidant of Hitler
- Theo Morell, personal physician of Hitler
- Franz Gurtner, president of the police, Munich
- Rudolf Steiner, founder of the antroposophic teaching
- W.O. Schumann, Prof. Dr. at the Technical University Munich
- Trebisch-Lincoln, occultist and traveler to the Himalayas
- Countess Westrap
- AND MANY OTHERS...

Later the Thule-Gesellschaft split in two, the esoterics (Greek: esoterós = the inner), among which counted Rudolf Steiner, and the exoterics (Greek: exoterós = the outer), who later were led by Hitler. The **Thule-Gesellschaft** is its inner core was peaceful in nature, besides knowing about *the Illuminati* and *El Shaddai*.

It was **Hitler** who became more radical. When Hitler had taken over the NSDAP, he prohibited the Thule and [the Vril Gesellschaften](#) after they had helped him to his position. Towards the end of the war he contacted them again, especially the Vril-Gesellschaft, because of their advanced technology and their special contacts.

A short history of "THULE"

"ULTIMA THULE" apparently was the capital city of the first continent peopled by Aryans. This was called HYPERBOREA and was older than [Lemuria](#) and [Atlantis](#) (continents with advanced cultures since submerged). The Scandinavians have a tale of "Ultima Thule", the wonderful land in the high North, where the sun never sets and the ancestors of the Aryan race dwell.

Hyperborea was up in the North Sea and sank during an ice age. It is assumed that the Hyperboreans came from the solar system Alderbaran which is the main star in the constellation Taurus, and that they were about four meters tall, white, blond and blue-eyed.

They knew no war and were vegetarians (so was Hitler). According to alleged Thule texts they were technically very advanced and flew "Vril-ya", flying machines that today we call UFOs. These flying disks were capable of levitation, extreme speeds and the maneuvers known from today's UFOs due to two counter-rotating magnetic fields and they used the so-called Vril power as energy potential or fuel (Vril = ether, Od, Prana, Chi, Ki, cosmic force, Orgon..., but also from the academic "vri-IL" = as the highest deity = *God-like*), i.e., they take the energy from the earth's magnetic field (free energy) like the "tachyon converter" of Captain Hans Coler.

When HYPERBOREA began to sink the Hyperboreans are said to have burrowed with huge machines gigantic tunnels into the Earth's crust and settled under the Himalayan region. The subterranean realm is called AGHARTA and its capital [SHAMBALLAH](#). The Persians call this land "Aryana" the land of origin of the Aryans.

Here we should mention that **Karl Haushofer** claimed that Thule was actually called Atlantis and – contrary to all other researchers of Tibet and India – he said that the surviving Thule-Atlanteans were separated into two groups, a good one and an evil one. Those who called themselves after their oracle Agharta were the good and settled in the Himalayan region, the evil ones were the Shamballah who wanted to subjugate humanity and they went West.

He maintained that the fight between the people of Agharta and Shamballah had been going on for thousands of years and that in the Third Reich the Thule-Gesellschaft as Agharta's representative continued it against the representatives of Shamballah, the Freemasons and the Zionists. This perhaps was his mission.

The head of this subterranean region he said was **Rigden Iyepo**, the king of the world, with his representative upon the Earth's surface, the [Dalai Lama](#). Haushofer was convinced that the land below the Himalayas was the birthplace of the Aryan race, which he claimed to have confirmed during his Tibet and India travels.

The symbol of Thule was the *swastika counter clockwise*. Tibetan lamas and the Dalai Lama personally testified that people from Agartha were still living today. The subterranean land that is anchored in almost all Eastern traditions has spread over the millennia under all of the Earth's surface with huge centers under the Sahara desert, the Matto Grosso and the Santa Catarina mountains in Brazil, Yucatan in Mexico, Mount Shasta in California, England, Egypt, Czechoslovakia.

It seems that **Hitler** especially sought to discover the entrances to the *subterranean world Agartha* and to get in contact with the descendants of the Aryan "*God people*" from Alderbaran-Hyperborea. In the myths and traditions of the subterranean world it is often said that the world's surface was yet to suffer a terrible world war (Third World War) which would though be ended by earthquakes, other natural disasters and a switching of the poles and the deaths therefrom of two thirds of humanity.

After this "last war" the several races of the inner earth would reunite with the survivors on the surface and that the thousand-year GOLDEN AGE (age of Aquarius) would be rung in. Hitler wanted to build an outer "Agartha" or "Aryana" with the Aryan master race, and Germany should be its home. During the existence of the "Third Reich" two large expeditions were sent by the SS to the Himalayas to find those entrances.

Further expeditions searched in the Andes, the Matto Grosso mountains in the North and the Santa Catarina mountains in the south of Brazil, in Czechoslovakia and parts of England.

Some authors claim that the Thule people believed that – quite independently of the subterranean tunnel and city system

– *the Earth was HOLLOW*, with two great openings at the poles. Natural laws were quoted, “as above, so below”. Since blood, body or egg cells, a comet or an atom all have a nucleus and a hollow space surrounding it that is enclosed by a “corona radiata”, an envelope, and the actual “life” is taking place in the core, one has deduced that the Earth was built after the same principles.

Druses confirmed this, as they were hollow and the “life”, the mineral and crystals, were in the interior. Therefore the Earth also had to be hollow – apparently agreeing with the views of the Tibetan Lamas including the Dalai Lama – and had a nucleus, the Central Sun (also called the “Schwarze Sonne”, the Black Sun) that gave the interior an even climate and permanent sunlight, corresponding in the microcosm to the central sun of the galaxy in the macrocosm.

They maintain that the actual life in our planet takes place in the interior – the master race lives inside and the mutants on the surface – and that this was also the reason why we wouldn’t find any life upon other planets of our solar system, because their inhabitants live inside. The main entrances are at the North and South poles through which the central sun is shining and producing the aurora borealis. In the interior the land mass was exceeding the water mass.

The polar explorer **Olaf Jansen** and others said that the water in the interior was fresh, which could explain why the ice of the Arctic and Antarctic is made of freshwater, not salt water. It is interesting to note that this view of the make-up of the world is shared and supported by the polar explorers Cook, Peary, Amundsen, Nansen, and Kane and, last but not least, Admiral E. Byrd. All had the same, strange experiences contradicting existing scientific theory.

All confirmed that after 76 degree latitude the winds became warmer, that birds flew north, that they found colored and gray snow which when thawed left colored pollen or volcanic ash. The question arises: where do flower pollen or volcanic ash near the North Pole come from, as not a single volcano is marked on any of the accessible maps? Further, some of the explorers found themselves in freshwater seas, and all say that at a time during their travels they had seen two suns. Mammoths were found whose flesh was still fresh and whose stomach contained fresh grass.

If you are further interested in the hollow Earth and the experience of the different explorers, some titles are listed under “Further Reading” at the back of this book. [The “Hollow Earth” theory](#) has so far remained just a theory to the public, although some authors and explorers claim to have visited there and even – like **Admiral E. Byrd** – had taken numerous pictures. It cannot be denied that all the Arctic explorers had had extraordinary experiences that so far cannot be explained, which points to something strange happening there.

But the theory that the Earth had a molten core has equally remained just a theory. The fact remains though that the subterranean man-made tunnel and cave systems do exist. They can be found in almost any country of the world and by the largely still existing light source (a greenish glow that gets brighter the deeper one enters the tunnels), by the smooth walls and the unknown machinery that was found in the Boynton Canyon in Sedona, Arizona, are witness to a technically advanced culture that existed millions of years before. Relevant literature is listed at the back.

The myths of a “**Hollow Earth**” were enough for the Thule people to go out to start a serious study of the phenomenon. Therefore there was at least one expedition to the Antarctic during World War II. (Details follow).

To show that the story of the Aryan-Hyperboreans was not entirely invented I would like to mention two examples: When the Spaniards under Pizarro came to South America in 1532, the natives called them “ivicarochas” (white lords). According to their legends there was a master race of very tall white people who centuries before had descended in “flying disks” from heaven. They had long ruled in some of the towns and when they disappeared had promised to return.

When the fair skinned Spaniards arrived, the natives thought them to be the *iviracochas* coming back and therefore in the beginning willingly gave them their gold. Similar occurrences took place when the first white travelers arrived in Tibet and other Himalayan regions. They were scrutinized in astonishment by the Tibetans and asked why they came from BELOW (the foot of the mountains) rather than from ABOVE as they usually did.

It is a pity that most Germans have never heard about these things, since the ideology of Nazi Germany was based on the *El Shaddai* theme and the resulting persecution of Jews, the *Revelation of Isais*, the *knowledge of the Templars* and possibly on the tales just told. All their actions including the Second World War were based thereupon. There are two possibilities to deal with this:

You think all the leaders of the “Third Reich” were mentally disturbed and drug addicts and you simply ignore all of this or You try to find out whether perhaps something of all this is true after all.

But to find literature about this subject you should not look in so-called “free” Germany, for the Allies had cleaned up very thoroughly after the war.

The activities of right wing radicals in Germany would justify the prohibition of some of the literature that openly and often

crudely calls for aggressive racism. But to truthfully render the political and religious events of the past and the present, this information should not be suppressed.

Now enough of these mysteries. As I will show you, the leadership of Germany became very active because of these myths.

In October 1918 **Sebottendorf** gave the lodge brethren KARL HARRER and ANTO DREXLER the task of forming a workers' circle which later became the DAP (German Worker's Party). The Thule-Gesellschaft had a newspaper, the Volkischer Beobachter which was soon taken over by the NSDAP (National Socialist German Worker's Party) into which the DAP soon developed.

In the same month the young occultist and esoteriscist ADOLF HITLER (actually **Adolf Schicklgruber**, Hitler was his mother's maiden name) entered the Thule-DAP and as a good speaker attracted attention. In his book *The Spear of Destiny*, **Trevor Ravenscroft** describes what Hitler's childhood friend WALTER JOHANNES STEIN, a later advisor of the Freemason WINSTON CHURCHILL, also said:

"Hitler, who already at twenty was a close adherent of mysticism, tried to reach higher states of consciousness with the help of drugs. The Viennese bookseller PRETSCHKE, who was a follower of the Germany mysticism and the resulting theory of an Aryan master race, helped Hitler to set the foundation of his future view of the world and also introduced him to the hallucinogenic PEYOTL as a means to get mystic illumination. At this time Hitler also got acquainted with the PROTOCOLS OF THE ELDERS OF ZION which only strengthened his objection of the Jews."

As Hitler was a drug addict already as a young man, it is no wonder he used through his whole life strong narcotics. According to the diaries of his personal physician DR. THEODOR MORELL, Hitler had different painkillers, tranquilizers, strychnine, cocaine, morphine derivatives and other drugs injected during all the six years of the Second World War. The Thule-Gesellschaft engaged Hitler as a speaker at election rallies.

Later the anti-Bolshevik and Thule-brother DIETRICH ECKART taught him how to write and speak properly. Eckart made Hitler what he later represented. He introduced him into the Munich and Berlin scenes and Hitler adopted the Thule views almost completely.

In 1924, when Hitler was imprisoned because of the failed Munich putsch, Haushofer spent several hours with him every day and passed his theories and plans on. Among the books he supplied to Hitler was Bulwer-Lytton's THE COMING RACE which tale about a highly developed subterranean Aryan race is almost identical to the one mentioned above.

In Bulwer-Lytton's book saucer-shaped flying ships play also an important role. A further book came to be published: Ferdinand Ossendowski's *BEASTS, MEN AND GODS* which told of the legends of Agartha and Shamballah. Hitler was completely taken in by the search for the subterranean realm and the Thule-Aryan race theory.

HAUSHOFER and RUDOLF HESS took on the political education of Hitler. In Landsberg Hitler used the theories of Haushofer, the thoughts of Rosenberg and political propaganda and mixed it all together. Rudolf Hess supplied the proper language and wrote it on the typewriter. In this way Hitler's book *MEIN KAMPF* (My Fight) was written. The role of mysticism and occultism in the "Third Reich" is shown by the influence of KARL HAUSHOFER who was called "The Greatest Magician of the German Reich". He was said to have a "prophetic gift" the accuracy of which helped him to quickly raise in the occult power circles of pre-war Germany.

**Jack Fisherman** wrote in his *The Seven Men of Spandau* that RUDOLF HESS was also completely taken in by Haushofer's thoughts and theories. The strange flight by Hess to England shows this. It was caused by a dream Haushofer had where he say "Rudolf Hess walking through the corridors of English castles and brought peace between the two greatest Nordic nations." Since Hess was convinced of the accuracy of Haushofer's prophecies he followed that dream without questions.

How much of the magic "equipment" of the Thule-Gesellschaft was used is shown in the following text:

Hitler took the Thule salute "Heil und Sieg" (Salvation and Victory) and made it into "Sieg Heil". This salute together with the raising of the arm is a magic ritual which is used to form *voltes*. Franz Bardon wrote more about *magic voltes* and their use. Franz Bardon (aka **Frabato**, 1909-1958) was the German magician I knew most about. He had been offered high posts in government by Hitler if he would help him win the war by his magic faculties. Bardon should also give Hitler the addresses of the other 98 "99 Lodges" – Hitler was a member of the Dresden lodge – that exist all over the world. When Bardon denied his help he was subjected to terrible torture.  
(**Franz Bardon: Frabato**).

Magic rites were not only used in Germany, though. The Victory sign of the English, the V-shaped fingers, was until 1940 only known to the highest of the high in high degree masonry. When the high degree Freemason **WINSTON**

**CHURCHILL** feared that England might fall victim to Hitler's successful hand magic (the German salute), his mentor in magic, the Satanist [ALEISTER CROWLEY](#) advised him to counter it with the two spread fingers.

The **SS**, also called the "**Black Order**", was everything but a police troop. It was a proper religious order of a hierarchical makeup. The brutal Nazi party as a holy order? In hindsight this seems ridiculous, until one notices that it wouldn't be the first time in history that a holy order was responsible for the most monstrous atrocities. The Jesuits, but also the Dominicans who ruled the Catholic Inquisition in the Middle Ages, are prime examples.

The **BLACK ORDER** was the practical realization of the esoteric and occult belief system of the Thule-Gesellschaft and the later SS "Schwarze Sonne" (Black Sun) not only worked closely together with the Tibetan colony in Berlin but also with a Tibetan order of black magic. Hitler was in constant contact with a "Guardian of the Key". He is said to have known the entrance to Agartha (Aryana).

On April 25, 1945, when the Russians found in a Berlin cellar the bodies of six Tibetans lying in a circle, the one lying in the center wore green gloves. It seemed they had committed group suicide. On May 2, 1945, after the Russians had entered Berlin more than 1,000 bodies were found who definitely came from the Himalayan region and had fought along with the Germans. What in the world had Tibetans to do here, thousands of kilometers from their country and in German uniforms?

Countless numbers of young men had been trained by the "Black Sun" during the Third Reich, initiated in the Wewelsburg and sent to Tibet to survive there and to prepare for the great final battle at the end of this century.

According to **Franz Bardon**, Adolf Hitler was also a member of a "**F.O.G.C. Lodge**" (*Freimaurerischer Orden der Goldenen Centurie, Dresden, Germany = Masonic Order of the Golden Century*) which is actually known as the "99 Lodges". There are 99 of these "99 Lodges" in many places of the world, all with 99 members.

Each lodge is presided by a demon, and each member has his personal demon. The deal is that the demon helps his person gain money and power, but his soul is after death committed to serve the demon. In addition one member is sacrificed every year to the lodge demon. It will be replaced by a new member. The members of the "99 Lodges" are also industrialists and bankers of the highest caliber and today are more important than ever. The "F.O.G.C." or "99 Lodges" are in my opinion the most dangerous, compared to which the "[Church of Satan](#)" of [Anton LaVey](#) that the media write about is harmless.

**Franz Bardon** confirmed that Hitler and the Thule order were the outer tool of a group of Tibetan magicians.

Only [one] who knows about those circumstances will understand this sentence from a speech by Hitler held on January 30, 1945:

"In this battle again inner Asia will not win, but Europe – led by that nation that for one and a half thousand years has represented Europe as vanguard towards the East and will continue to do so in all eternity: Our great German Reich, the German nation!  
(Max Domarus: *Hitler – Speeches and Declarations 1932-1945*).

There are also many myths about the whereabouts of **Adolf Hitler** after the War. According to [Franz Bardon](#) and [Miguel Serranos](#) (former Chilean ambassador to Germany) Hitler escaped with the help of the "99 Lodge". This is perhaps easier to understand if one knows that Hitler used up to five doubles during his tenure. A large German newspaper wrote on March 5, 1979 that Hitler's private plane had been found in the jungle in South America.

**Joseph Grenier** (*The End of the Hitler Myth*) also states that Hitler had taken off in his plane from Berlin-Tempelhof on April 30, 1945. Later, around the time of the Nuremberg trials, it is said that Stalin asked U.S. officials whether they knew where Hitler was? If Hitler had died in Berlin in 1945, why would Stalin ask?

If Hitler did survive, however, it is most probable that he had availed himself of the developments by [the VRIL-GESELLSCHAFT](#) – which I will describe in the following chapter - for leaving Germany. Whether Hitler died then or not – in the meantime he died anyway!

On March 14, 1946, **Karl Haushofer** had, since his mission had failed, first killed his wife and then committed "seppuku" (hara-kiri) as the "Yellow Hats" had made him swear. The theoretical and practical buildup of the Third Reich on the German side had been wholly initiated and steered by the Thule-Gesellschaft. The financing came from the international bankers. The womb from whence it all came is still fertile, since the **Thule-Gesellschaft** or its offspring are still with us today.

Another secret group that spoke of the coming of an Aryan Savior and to which [Hermann Goering](#), the Nazi's finance chief, belonged was the "EDELWEISS-GESELLSCHAFT". But here it does not concern us.

[Back to Contents](#)

[Back to The Thule Society](#)

## CHAPTER 33

### THE “VRIL-GESELLSCHAFT” OR NOT ALL GOOD COMES FROM ABOVE

The VRIL-GESELLSCHAFT ([VRIL Society](#)) does not exactly fit or subject which has a more political slant, but it is indeed one of the most interesting secret societies that ever existed. Therefore is just has to be mentioned here. In Germany there is not a single book, or indeed any material, to be found that would show up an organization of this name; the Allies successfully removed it all. But as you will see, not all the material has actually disappeared.

And I am very pleased that I can uncover this subject here, because you will see which “non-German” power circles have an interest to keep these events from the German people. In 1919, Karl Haushofer founded a second order, the BRUDER DES LICHTS (Brothers of the Light) that later was renamed VRIL-GESELLSCHAFT.

In this united the new Templar order DIE HERREN VOM SCHWARZEN STEIN (DHvSS, the Lords of the Black Stone) that emerged in 1917 from the Teutonic Order, and the SCHWARZE RITTER (Black Knights) of the Thule and SS elite SCHWARZEN SONNE (Black Sun).

To compare the THULE and the VRIL-GESELLSCHAFTEN, it is easiest said the Thule-Gesellschaft dealt with material and political interests, while the Vril-Gesellschaft was more oriented towards the OTHER SIDE. But many concepts they shared, like Atlantis, Thule, the basic connection between the Teutons and Mesopotamia, but also the old sacred places like the Externsteine (external stones) or the Hausberg at Stronegg were areas of common research.

In December 1919 a small circle of persons from the Thule, the Vril and the DHvSS met in a specially rented forester’s lodge near Perchtesgaden (Germany). They were accompanied by the medium **Maria Orsic** and another medium only known as Sigrun. Maria had mediumistically received transmission in a secret Templar script – a language unknown to her – with the technical data for the construction of a flying machine. According to Vril documents these telepathic messages came from the solar system Aldebaran which is sixty-eight light-years away in the constellation Taurus.

I would like to present here a short summary of the messages *the Vril medium* had received over the years and which formed the basis for all further actions by the **Vril-Gesellschaft**:

“The solar system Aldebaran has a sun around which revolve two inhabited planets that form the empire SUMERAN. The population of the Aldebaran system is divided into the master race of “light *God* people” (Aryans) and several other human races that had developed by negative mutation from the “*God* people” because of climatic changes upon the planets.

The colored mutant races apparently are on a lower stage of spiritual development. The more the races intermixed, the lower the spiritual development of these people sank, which led to the situation that when the sun Aldebaran began expanding they could no longer maintain the space travel technology of their forefathers and could not leave the planets by their own means. The lower races, totally dependant upon the master race, had to be evacuated and were brought to other inhabitable planets. Despite their difference all the races respected one another and did not interfere with each other, neither the so-called *God people* nor the lower races. Each respected that the others just made their own developments (in contrast to what happens on Earth).

“Around 500 million years ago the “light *God* people” started to colonize other earth-like planets, after the expansion of the sun Aldebaran and the resulting heat had made the original planets uninhabitable. It is said that in our system they first colonized the planet Mallona (also called Maldek, **Marduk** or – by the Russians – Phaeton) which existed in the area of today’s asteroid belt, then between Mars and Jupiter. Mars was next. The proof for a highly developed race on Mars is run by the well-known [face on Mars and the pyramid city](#) which has been photographed by the Mars probe Viking in 1976. It is assumed that the master race of Sumeran-Aldebaran then also came to Earth for a first visit, witnessed by the petrified impressions of a shoe found to be about 500 million years old, and squashed under the

heel a trilobite, a little crayfish that lived then upon Earth and became extinct about 400 million years ago.”

“The Vril people thought that later, when Earth became slowly habitable, the race of the Aldebarans landed in Mesopotamia and formed the master caste of the SUMERIANS which were described as fair, white *God* people. The Vril telepaths also found that the Sumerian language was not only identical with that of the German and that the language frequently of German and Sumerian-Aldebaranian were almost identical.”

We cannot know whether these statements about Aldebaran were based on facts, but the construction plans and the technical details that the Vril telepaths received – wherever they came from – were so accurate that they led to the most fantastic idea men ever begot: the construction of a “*Jenseitsflugmaschine*”, a “flying machine for the other side”!

The concept of an “alternative science” emerged (today one would say “alternative energy forms”). But they only started on the project three years later. During this early phase of “alternative science” or “alternative technology”

Dr. **W.O. Schumann** of the Technical University in Munich, both a Thule and a Vril member, held a speech, a section of which is reproduced here:

“In everything we recognize two principles that determine the events: light and darkness, good and evil, creation and destruction – as in electricity we know plus and minus. It is always: either – or.

“These two principles – the creative and the destructive – also determine our technical means...

“Everything destructive is of Satanic origin, everything creative is divine. Every technology based upon explosion or combustion has thus to be called Satanic. The coming new age will be an age of new, positive, divine technology!”  
(from the German SS secret archives).

At the same time the scientist VIKTOR SCHAUBERGER worked on a similar project. **Johannes Kepler**, whose ideas Schauberger followed, had knowledge of the secret teachings of Pythagoras that had been adopted and kept secret by the KNIGHTS TEMPLAR. It was the knowledge of *IMPLOSION* (in this case the utilization of the potential of the inner worlds in the outer world). **Hitler** knew – as did the Thule and Vril people – that the divine principle was always constructive.

A technology however that is based on explosion and therefore is destructive runs against the divine principle. Thus they wanted to create a technology based on IMPLOSION. Schauberger’s theory of oscillation (principled of the overtone sequence, monochord) takes up the knowledge of Implosion. To put it simply: IMPLOSION instead of EXPLOSION! Following the energy paths of the monochord and the implosion technology one reaches the realm of antimatter and thus the cancellation of gravity.

In the summer of 1922 the first saucer-shaped flying machine was built whose drive was based on implosion (the “other-side flying machine”). It had a disk eight meters across with a second disk with a diameter of six and a half meters above and a third disk of seven meters diameter below. These three disks had a hole at the center of one meter eighty across in which the drive, which was two meters forty high, was mounted. At the bottom, the central body was cone-shaped, and there a pendulum reaching the cellar was hung that served for stabilization. In the activated state the top and bottom disk revolved in opposing directions to build up an electromagnetic rotating field.

The performance of this first flying disk is not known. But experiments were carried out with it for two years before it was dismantled and probably stored in the Augsburg works of *Messerschmidt*. In the books of several German industrial companies entries under the codename **JFM** (for *Jenseitsflugmaschine*) can be found that show payments towards financing this work. Certainly the *VRIL DRIVE* (formally called Schumann SM-Levigator) emerged from this machine.

In principle, the “other-side flying machine” should create an extremely strong field around itself extending somewhat into its surroundings which would render the space thus enclosed including the machine a microcosm absolutely independent of the earthbound space. At maximum strength this field would be independent of all surrounding universal forces – like gravitation, electromagnetism, radiation and matter of any kind – and could therefore maneuver within the gravitational or any other field at will, without the acceleration forces being effective or perceptible.

In June 1934, VIKTOR SCHAUBERGER was invited by **HITLER** and the highest representatives of the Thule and Vril Societies and from then on worked with them. After the initial failure, the first so-called German UFO also came out in June 1934. Under the leadership of Dr. **W.O. Schumann**, the first experimental round flying machine, the RFZ 1 (Rundflugzeug I) was developed on the grounds of the aircraft factory Arado in Brandenburg. In its first and only flight it rose vertically to around 60 meters, then wobbled and danced in the air for minutes. The Arado 196 guiding system was



utterly useless. The pilot Lothar Waiz just managed somehow to bring it down to the ground, jump out and run away before it ripped to pieces. That was the end of the RFZ 1, but the beginning of the VRIL flying machines.

Before the end of 1934, the RFZ 2 was ready, with a Vrill drive and a “magnetic field impulse steering unit”. It had a diameter of five meters and the following flying characteristics: With rising speed the visible counters became blurred and the craft showed the colors typical of UFOs: depending on the drive setting red, orange, yellow, green, white, blue or purple. It worked – and it would meet a remarkable destiny in 1941, during the Battle of Britain, when it was used as transatlantic reconnaissance craft, because for these flights the German standard fighters ME 109 had an insufficient range.

By the end of 1941 it was photographed over the southern Atlantic on its way to the German cruiser Atlantis in Antarctic waters. It could not be used as a fighter though. The impulse steering allowed it only changes of direction at 90 degrees, 45 degrees or 22.6 degrees, but that is exactly the right-angled flying pattern associated with and typical for UFOs today! After the success of the small RFZ 2 as a distant reconnoiter craft the Vrill-Gesellschaft got its own test area in Brandenburg.

By the end of 1942 the lightly armed VRIL-1-Jäger (VRIL1-fighter) was airborne. It measured 11.5 meters across, carried one person, had a Schumann-Levigator drive and a “magnetic field impulse steering unit”. It reached speeds of 2,900 to 12,000 km/h. could change direction at a right angle at full speed without affecting the pilot, could fly in any weather and had a 100% space capability. Seventeen VRIL-1s were built and some versions had two seats and glass domes.

Also during this time another project was worked on, the V-7. Several disks were built under this code, but with conventional jet engines. ANDREAS EPP had designed a combination of levitating disk and jet propulsion, the RFZ-7. The design groups SCHRIEVERHABERMOHL and MIETHE-BELLUSO worked on it. The RFZ-7 had a diameter of forty-two meters, it crashed on landing at Spitzbergen, A second craft was later photographed outside Prague. According to Andreas Epp this craft was to be armed with nuclear head to attack New York.

In July 1941 SCHRIEVER and HABERMOHL built a vertical take-off round craft with jet propulsion, but it had severe shortcomings. They went on to develop an “electrogravitational flying gyro” with a “tachyon drive” which proved more successful. Then, Schriever-Habermohl and Belluzo built the RFZ-7 T that was fully functional. The V-7 flying disks however were mere toys compared to the Vrill and Haunebru disks.

Within the SS there was a group studying alternative energy, the SS-E-IV (Development Group IV of the Black Sun) whose main task was to render Germany independent of foreign oil. The SS-E-IV developed from the existing Vrill drives and the tachyon convertor of Captain **Hans Coler** the THULE DRIVE which later was called the THULE TACHYONATOR.

In August 1939 the first RFZ 5 took off. It was an armed flying gyro with the odd name HAUNEBRU I. It was twenty-five meters across and carried a crew of eight. At first it reached a speed of 4.800 km/h, later up to 17,000 km/h. It was equipped with two 6 cm KSK (“Kraftstrahlkanhonen”, power ray guns) in revolving towers and four machine guns 106. It had 60% space capability.

By the end of 1942 the HAUNEBRU II was ready. The diameters varied from twenty-six to thirty-two meters and their height from nine to eleven meters. They carried between nine and twenty people, had a Thule Tachyonator drive and near the ground reached a speed of 6,000 km/h. It could fly in space and had a range of fifty-five flying hours. At this time there existed already plans for a large-capacity craft, the VRIL-7 with a diameter of 120m.

A short while later the HAUNEBRU III, the show-piece of all disks, was ready, with seventy-one meters across. It was filmed flying. It could transport thirty-two men, could remain airborne for eight weeks and reached at least 7,000 km/h (according to documents in the secret SS archives up to 40,000 km/h).

**Virgil Armstrong**, former CIA member and Green Beret, writes about German flying machines during World War II that could take off vertically and fly at right angles. They were measured at 3,000 km/h and had a laser weapon (probably the so-called KSK power ray gun) that could pierce four-inch armor.

Professor **J. Hurtak**, UFO-logist and author of *The Keys of Enoch* writes that the German were in the process of building what the Allies called “the wonder weapon system”. Hurtak got protocols that described two events; the erection of a space city at Peenemunde and the enlistment and transport to the U.S. of the best technicians and scientists from Germany.

He also mentions the meticulous examination of the so-called FOO FIGHTERS.

The CIA and the British secret service knew already in 1942 about the construction and the use of these flying objects, but they were off in their evaluation. Foo Fighters actually was the Allies' name for all glowing German flying machines. Probably there were two inventions that actually corresponded to the term Foo Fighters: the Flying Turtle and the Soap Bubble. Two completely different objects that the Allies held for one.

The FLYING TURTLE was developed by the SS-E-IV at Vienna-Neustadt. Its outer shape recalled the shell of a turtle. They were unmanned probes that could cause disruption in the electric ignition systems of the enemy. They carried advanced "Klystronohren" (clystron tubes) that the SS called death rays. The ignition disrupter did not work perfectly at the outset; later follow-up versions did, however, and the UFO-logist will confirm that disruption of ignition, the cutting of electrical power to equipment, is a typical sign when a UFO is near.

**Wendelle C. Stevens**, U.S. Air Force pilot during the Second World War describes the Foo Fighters as sometimes gray-green, then red-orange, they approached his aircraft to about five meters and then stayed there. They could not be shaken off nor shot down and often they caused squadrons to turn back to land.

The SOAP BUBBLES that were also called Foo Fighters were something completely different, though. They were simple balloons in which there were metal spirals that disturbed enemy radar. The success probably was very limited, disregarding the psychological effect.

At the beginning of 1943 it was planned to build in the Zeppelin works a cigar-shaped mother ship. The ANDROMEDA DEVICE of a length of 139m should transport several saucer-shaped craft in its body for flights of long duration (interstellar flights). By Christmas 1943 an important meeting of the VRIL-GESELLSCHAFT took place in the seaside resort of Kolberg.

The two mediums Maria Ortic and Sigrun attended. The main item on the agenda was the ALDEBARAN PROJECT. The mediums had received precise information about the habitable planets around the sun Aldebaran and one began to plan a trip there. At a January 22, 1944 meeting between HITLER, HIMMLER, Kunkel (of the Vril Society) and Dr. Schumann this project was discussed. It was planned to send [the VRIL-7](#) large-capacity craft through a dimension channel independent of the speed of light to Alderbaran.

According to **Ratthofer**, a first test flight in the dimension channel took place in the winter of 1944. It barely missed disaster, for photographs show the Vril-7 after the flight looking "as if it had been flying for a hundred years". The outer skin was looking aged and was damaged in several places.

On February 14, 1944, the supersonic helicopter – constructed by Schriever and Habermohl under the V7 project – that was equipped with twelve turbo-units BMW 028 was flown by the test pilot Joachim Roehlike at Peenemunde. The vertical rate of ascent was 800 meters per minute, it reached a height of 24,200 meters and in horizontal flight a speed of 2,200 km/h. It could also be driven with unconventional energy. But the helicopter never saw action since Peenemunde was bombed in 1944 and the subsequent move to Prague didn't work out either, because the Americans and the Russians occupied Prague before the flying machines were ready again.

In the secret archives of the SS the British and the Americans discovered – during the occupation of Germany at the beginning of 1945 – photographs of the Haunebru II and the Vril 1 crafts as well as of the Andromeda device. Due to President Truman's decision in March 1946 the war fleet command of the U.S. gave permission to collect material of the German high technology experiments.

Under the operation PAPERCLIP German scientists who had worked in secret were brought to the U.S. privately, among them VIKTOR SCHAUBERGER and WERNHER VON BRAUN.

A short summary of the developments that were meant to be produced in series:

The first project was led by Prof. Dr. W.O. Schumann of the Technical University of Munich. Under his guidance seventeen disk-shaped flying machines with a diameter of 11.5m were built, the so-called VRIL-1-Jager (Vril-1-fighters), that made 84 test flights. At least one VRIL-7 and VRIL-7 LARGE CAPACITY CRAFT APPARENTLY STARTED FROM Brandenburg – after the whole test area had been blown up – towards Aldebaran with some of the Vril scientists and lodge members.

The second project was run by the SS-IV development group. Until the beginning of 1945 they had three different sizes of bell-shaped space gyros built:

1. The **Haunebru I**, 25m diameter, two machines built that made 52 test flights (speed 4,800 km/h).

2. The **Haunebru II**, 32m diameter, seven machines built that made 106 test flights (speed 6,000 km/h). The Haunebru II was already planned for series production. Tenders were asked from the Dornier and Junkers aircraft manufacturers, and at the end of March 1945 the decision was made in favor of Dornier. The official name for the heavy craft was to be DO-STRA (Dornier STRAtospheric craft).
3. The **Haunebru III**, 71m diameter, only one machine built that made at least 19 test flights (speed 7,000 km/h).

The *ANDROMEDA DEVICE* existed on the drawing board; it was 139m long and had hangars for one Haunebru II, two Vril I's and two Vril II's. There are documents showing that the VRIL-7 large capacity craft had started for secret, still earth-bound, missions after it was finished and test flown by the end of 1944. A landing at the Mondsee in the Salzkammergut in Austria, with dives to test the pressure resistance of the hull.

Probably in March and April 1945 the VRIL-7 was stationed in the "Alpenfestung" (Alpine Fortress) for security and strategic reasons, from whence it flew to Spain to get important personalities who had fled there safely to South America and NEUSCHWABENLAND (explanation follows) to the secret German bases erected there during the war. Immediately after this the VRIL-7 is said to have started on a secret flight to Japan about which however nothing further is known.

What happened to these flying machines after the war?

It cannot be excluded that a small series of the Haunebru II might have been built. The several photographs of UFOs that emerged after 1945 with the typical features of these German constructions suggest as much.

Some say that some of them had been sunk into the Austrian Mondsee, others maintain that they were flown to South America or brought there in parts. It is certain though that if the crafts didn't get to South America, the plans that did allowed for new ones to be built and flown there, for an important part had been used in 1983 in the "Phoenix Project", the follow-on project of the 1943 "Philadelphia Experiment". This was a teleportation, materialization and time travel experiment of the U.S. Navy that was more successful than you could imagine in your wildest dreams. There is enough material for another book, but it does not fit too well into our subject here.

In 1938 a [German expedition to the ANTARCTIC was made with the aircraft carrier Schwabenland](#) (Swabia). 600,000 km<sup>2</sup> of an ice-free area with lakes and mountains were declared German territory, the NEUSCHWABENLAND (New Swabia). Whole fleets of submarines of the 21 and 23 series were later headed towards **Neuschwabenland**.

Today about one hundred German submarines are still unaccounted for some equipped with the Walter snorkel, a device that allowed them to stay submerged for several weeks, and it can be assumed that they fled to Neuschwabenland with the dismantled flying disks or at least the construction plans. Again it must be assumed that since the test flights had been very successful some so-called flying saucers have flown directly there at the end of the war. Perhaps some may think these assumptions to be a bit on the daring side, but there are strong indications that it may well have happened that way.

There is a question why in 1947 ADMIRAL E. BYRD led an invasion of the ANTARCTIC, why he had 4,000 soldiers, a man-of-war, a fully equipped aircraft carrier and a functioning supply system at his command if it was a mere expedition? He had been given eight months for the exercise, but they had to stop after eight weeks and high losses of planes undisclosed even today. What had happened?

Later Admiral Byrd spoke to the press:

"It is the bitter reality that in the case of a new war one had to expect attacks by planes that could fly from Pole to Pole."

Further he added that there was an advanced civilization down there that used their excellent technologies together with the SS.

**Norbert-Jurgen Ratthofer** writes about the whereabouts of the Haunebru developments in his book "*Zeitmaschinen*" (Time Machines):

"The Haunebru I, II and III space gyros and the VRIL I space flying disk had disappeared after May 1945. It is very interesting to note in the context that after its nineteenth test flight the German Haunebru III is said to have taken off on April 21, 1945, from Neuschwabenland, a vast, officially German territory in the Eastern Antarctic, for an expedition to Mars, about which there is nothing further known. One year later, in 1946 the many sightings that suddenly occurred in Scandinavia of shining objects of unknown and definitely artificial origin caused a great stir among the Allies in East and West. Again one year later, in 1947, and well into the Fifties, a rising number of shining unknown flying objects, doubtlessly steered

by intelligent beings mostly round, disk- or bell-shaped, sometimes cigar-shaped, so-called UFOs appeared over North America..”

The text goes on to say that as a rule these objects were unlike the German developments. I beg to differ. Good photographic material proves that the Haunebru II version especially had been sighted very often since 1945.

If you have wrestled with what is available in the UFO world for ten years as I have, that is a significantly high percentage of the cases where personal contacts with the people from the so-called UFOs were made, these were with especially beautiful Aryan types, blond and blue-eyed and that they either spoke fluent German or another language with a German accent (for insiders I would refer to the Adamski case of 1952, the Cedric Allingham case of 1954 and the Howard Menger case of 1956).

It is further said that color photographs taken by a night guard in West Germany in the Seventies exist of a landed and restarted flying disk that had both a knight's cross and a swastika on its hull.

The flying machines just mentioned are well documented on photographs and films. There is the 60-Minutes documentary “UFO – Secrets of the Third Reich”. The American **Vladimir Terziski** gave a three-hour speech at the September 1991 UFO conference in Phoenix, Arizona, where he showed slides of German saucers, construction plans and subterranean German bases.

Also of interest are the book by the Italian Air Force commander **Renato Vesco** and the book by **Rudolf Lusar** “*Die Deutschen Waffen und Geheimwaffen des Zweiten Weltkrieges und ihre Weiterentwicklung*” (The German Arms and Secret Weapons of the Second World War and Their Development), J.F. Lehmanns Verlag, Munich 1971.

Do you see now why the subject of UFOs is treated as nonsense by the media, especially in Germany? Upon this German background it becomes evident that the news and media world controlled by the Illuminati through the Anglo-American Zionist lobby shirks no costs to keep the German citizens from research in this area.

The Question arises from where the Thule and Vril secret societies got their knowledge about the construction of these flying machines? Also their knowledge of gene technology in which area the Germans were also way ahead of other countries?

According to **Herbert G. Dorsey** and other researchers they had, beside the construction plans the Vril-Gesellschaft had received through telepathic contact with extra-terrestrials, a non-terrestrial saucer that had crashed in the Black Forest in 1936 and whose undamaged drive had proved a great help to the Germans. But there is practically no proof of that, and no living eye witnesses are known.

But these exist in America, and in large numbers. For around the same time the Americans recorded quite a number of crashes that could not be kept entirely secret. More of that later. Back to the political arena. Apart from the fact that I.G. Farben supported Hitler, their cartel partner Standard Oil (Rockefeller) fanned the flames against the Nazis. The Ford Motor Company for instance helped to build up the American army while at the same time producing in Germany military vehicles for the Nazis. Ford and Opel (subsidiary of General Motors that is controlled by J.P. Morgan) were the two largest producers of tanks in Hitler's Germany.

Whatever the outcome of the war, these multinational companies had already made their cuts. Many enterprises followed this principle during the Second World War.

- Why is there nothing about all this in schoolbooks or encyclopaedias?
- Especially in Germany where the freedom of the press is apparently honored and the truth is taught?

One of the reasons is that the Rockefeller Foundation spent US\$ 139,000 in 1946 to present an official history of the Second World War which covered up the whole story of the U.S. bankers building up the Nazi regime as well as the occult and mystical background of the Nazis. One of the main sponsors was Rockefeller's own Standard Oil Corp.

[Back to Contents](#)

[Back to The Vril Society](#)

[Back to German Disc Aircrafts](#)

# UFO's and The Occult Reich

by **TAL Levesque**  
Nevada Aerial Research Newsletter

Many civilizations with “flying saucers” exist, and are hidden inside this planet. Beings which generate out of their own thought, various craft which are among us. There are also the **UFO** craft that are built by surface cultures.

All these are linked together in various ways. Most all of these are OCCULT (hidden)... and most are “messengers of deception”.

In 1867, **Wentworth Little** founded the *English Rosicrucian Society*. He was in contact with the German Rosicrucians. Little recruited his followers, up to 144 people, from the ranks of the higher-ranking “Freemasons”.

One of his disciples was **Bulwer Lytton**, who was a learned man celebrated throughout the world for his novel “The Last Days of Pompeii”. He also wrote “[The Coming Race](#)” which featured a mystical pre-Nazi group in Germany.

This Berlin group called itself the “Luminous Lodge”, or “[Vril Society](#)” **Vril** (like the force) has enormous energy potential. The book describes a race of men physically far in advance of surface humans. They have acquired powers over themselves and over all material objects.

They lived in caves and would emerge to reign over the surface world. The most prominent member of the Vril Society was **Karl Haushofer**, a close confidant of [Hitler](#), [Hess](#) and [Rosenburg](#), who all belonged to the **Thule Society** (*Thule Gesellschaft*) that was founded in Munich in 1918.

Thule was a neo-Gnostic racist group, which became a rallying front for the societal roots of Nazi thought. The chief architect of the Thule group was [Baron Rudolf von Sebottendorff](#) (**Rudolf Glauer**) who had direct contact with the Dervish Orders and knew a great deal about Islamic mysticism, particularly Sufism in all its aspects. He also had contact with [Herman Pohl](#), leader of the *German Order Walvater of the Holy Grail*.

Nazi occultism was a mixture of influences and a host of interrelated secret societies, including the [Bavarian Illuminati](#), the Knights Templar, the Teutonic Knights, the Holy Vehm, the Golden Dawn, the Rosy-Cross, the [Vril Society](#), the German Order and its offshoot, the **Thule Society**.

*Thule* is known as the capital of *Hyperborea*, in the polar regions.

Also known as “*Ultima Thule*”, it was the gateway to other worlds.

It was known to serve as both a place to leave the earth and a place on the rim of the opening to [the “hollow earth”](#). It is interesting to note that the major powers of the earth have microwave stations setup in the area, broadcasting ELF waves on brain-wave frequencies.

Tradition has it that *Hyperboreans* were in contact with various “alien cultures”. War supposedly broke out between the *Hyperboreans* and other civilizations (atomic war).

Descendants of the *Thule caste* (Celts) emigrated elsewhere to other areas of the planet. They colonized these areas, driven by “memory chromosomes” inherited from their space-travelling ancestors.

These [star seed people](#) are mostly of Celtic origin (Basques, Irish, English, Norsemen, Icelanders, Bretons, Spaniards and Portuguese) which, strangely enough, make up the largest percentage of **RH-NEGATIVE blood types**.

Current neo-Nazis are allegedly trying to locate and control these people. Apparently, most contactees have RH-blood type. Are UFO cultures tracking their own “cross-breeds”?

The *Grand Lodge of Vril* was seeking to re-unite the ancient Aryan traditions and to make contact with the original super-human “luminous race” and to make an alliance with beings who have secret sanctuaries hidden inside the planet.

The book “*UFOs - NAZI SECRET WEAPON?*” by **Mattern-Friedrich** brings out some interesting information, It seems that **Victor Schauburger** (1885-1958) invented a number of “flying disks” for the Nazis between 1938 and 1945.

**Vanguard Notes...**

We have seen a copy of a letter from [Schauberger](#) to a friend which states that he worked at Matthausen concentration camp directing technically oriented prisoners and other German scientists in the successful construction of a saucer.

In this letter written by **Schauberger**, he gives further information from his direct experience with the German military:  
"The "flying saucer" which was flight-tested on the 19th February 1945 near Prague and which attained a height of 15,000 meters in 3 minutes and a horizontal speed of 2,200 km/hours, was constructed according to a Mod I 1 built at Mauthausen concentration camp in collaboration with the first-class engineers and stress-analysts ASSIGNED TO ME from the prisoners there.

It was only after the end of the war that I came to hear, through one of the workers UNDER MY DIRECTION, a Czech, THAT FURTHER INTENSIVE DEVELOPMENT WAS IN PROGRESS. However, there was no answer to my enquiry.

From what I understand, just before the end of the war, the machine is SUPPOSED TO HAVE BEEN DESTROYED on Keitel's orders. That's the last I heard of it.

In this affair, several armament specialists were also involved who appeared at the works in Prague, shortly before my return to Vienna, and asked that I DEMONSTRATE the fundamental basis of it:  
The CREATION OF AN ATOMIC LOW-PRESSURE ZONE, which DEVELOPS IN SECONDS when either AIR or WATER IS CAUSED TO MOVE RADially AND AXIALLY under conditions of a FALLING TEMPERATURE GRADIENT."

---

**Schauberger** and his son lived in the United States for a short time after the war, where he was reported to be working on a top secret UFO project in Texas for the US Government.

Reports of Aryan looking saucer pilots are many. Long haired blond folks that speak German. It is interesting to note that the so-called "venusian" saucer design of contactees all look like German saucer designs. The **Thule Society** is still alive in the minds of neo-Nazi (Fourth Reich) occultists.

There is a booklet going around that reports to be the secret log of [Admiral Richard Byrd](#). In 1978, copies were sent out by the *Hollow Earth Research Society* in Ontario, Canada.

**Ivan Boyes**, its director, claims that "after the war, the allies discovered that over 2,000 scientists from Germany and Italy had vanished along with almost a million people to the Land beyond the pole."

This is apparently what Admiral Byrd's expedition was all about. To hunt them down. The domain of *the Arianni*. The "Flugelrads" (*wingwheels*) were noted in the secret log as being sent to the surface world to investigate the first nuclear explosions. These were the model T's of the *German saucer design*.

Do we have a myth in the making? So... **Admiral Byrd** goes back and tells the Pentagon and the President what he has seen. They order him to be silent.

It seems that the inner earth cavern civilizations and the lands inside the earth have been a part of the occult/military secret for a long time.

Return to The Thule Society  
Return to German Disc Aircrafts

# Vril Society

## "The Yellow Book" no 5

Extracts pages 154 to 170

by Barry Taylor  
original [French Version](#)  
from [TheOZFactorUFOResearch](#) Website



At first sight, **the Vrili Society** should not be brought into the scope of our subject which is more concerned with politics, but it is one of the most interesting secret societies which has ever existed. That is why it is absolutely necessary for us to mention it.

There is not a single book in German on this *Vrili Society* and every other document which could have given a cross-reference to the name has been well and truly obliterated by the Allies. But, as you will see, not everything about it has disappeared. And it is a special pleasure for me to unveil this matter to you here.

In effect, you are going to verify which of the non-German power circles keep secret the truth about the Germans.

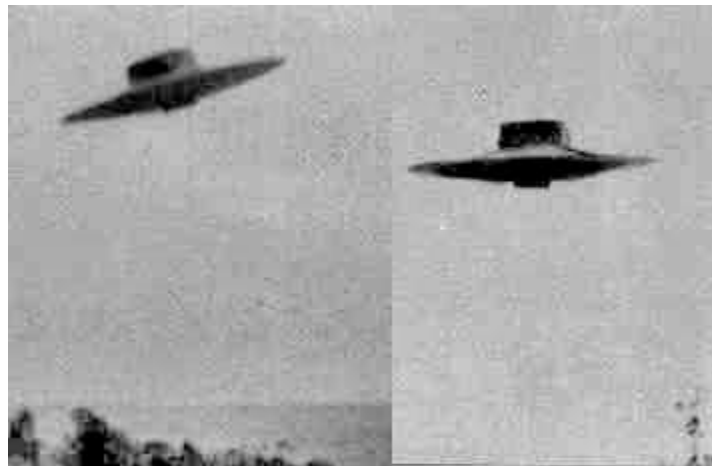

**Karl Haushofer** founded, before 1919, a second order, the Brothers of the Light, which later took the name of the Vril Society. In this were united also the Masters of the Black Stone (DHvSS), a new founding of the Templars, from the order of Germain in 1917, and the Black Knights of the Black Sun, the élite of the Thule Society and the SS.

If we compare the Vril Society to the Thule Society, the difference can be summarized thus:

- the Thule Society occupied itself with material and political matters
- the Vril Society was concerned above all with the beyond

However, they had some points in common.

Both studied Atlantis, Thule, the Island of the Fortunate of Gilgamesh, the original relationships between the Germans and the Mesopotamians as well as the ancient sanctuaries like Stonehenge with its towering stones.

In December 1919, a forest house was rented in the Ramsau, near Berchtesgaden, where some people from the Thule, DHvSS and Vril Societies met. Among them were the mediums Maria Orsitsch and Sigrun. Maria had received some information in a secret script of the Templars - a language completely unknown to her - with technical data on constructing a flying machine.

These telepathic messages were transmitted, according to the written records of the Vril Society, from the solar system of Aldebaran, in the constellation of Taurus.

We wish to present to you a summary of the messages which were received for some years by the Vril Society telepaths, which were the basis of the further actions taken by that Society.

## Aldebaran

The solar system of Aldebaran is 68 light-years from Earth, and two inhabited planets which constitute the Realm of Sumeran orbit around their sun.

The inhabitants of this solar system are subdivided into masters, White God-like people (Aryans) and other different human races. These latter developed because of climatic changes on the individual planets, and were the result of a degeneration of the God-like people. These mutants came to have a spiritual development inferior to the God-like people.

The more the races mixed together, the more their spiritual development was degraded. Consequently, when the sun (Aldebaran) began to expand, they were no longer able to make interplanetary voyages like their ancestors; it had become impossible for them to leave their planets.

Thus the inferior races, totally dependent on the masters, came to be evacuated in spaceships and taken to other habitable planets. In spite of the differences, there was respect between these two races, they did not encroach upon each other's living space (in contrast to Earth).

The race of the masters, the White God-like people, had started to colonize other planets similar to Earth 500 million years ago, following the expansion of the Aldebaran sun and the growing heat resulting from it, which made the planets uninhabitable. It was said that they colonized the planet Mallona (also called Maldek, Marduk, or Phaeton by the Russians) in our solar system, which existed at that time between Mars and Jupiter, where the asteroids are found today.

After that, Mars, of which the great pyramid cities and the well-known [Martian face](#), photographed in 1976 by the Viking probe, bear witness to the high level of development of its inhabitants. From there, in that era, it was assumed that the God-like people of Sumeran Aldebaran came to Earth for the first time.

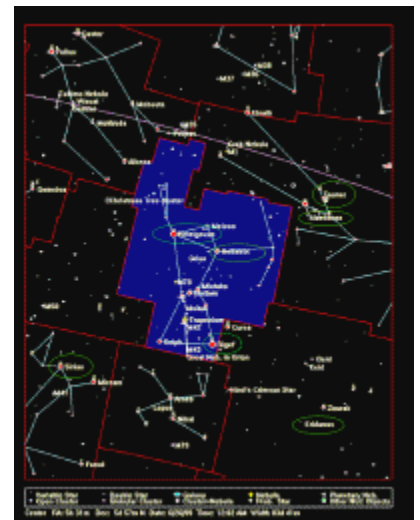



Old traces of a petrified shoe about 500 million years old, with a trilobite petrified together with the sole of that shoe, bear witness to it. That primitive fish lived on Earth then, and disappeared 400 million years ago.

The Vril Society members thought that the Aldebaranians landed later on, when the Earth became slowly habitable, in Mesopotamia, and that they formed the dominant caste of the Sumerians. These Aldebaranians were called White God-people. Moreover, the Vril telepaths received the following information: [the Sumerian](#) language was not only identical to that of the Aldebaranians, but it also had tones similar to German, and the frequency of the two languages was almost identical.

Does this correspond with reality? Let us say simply that the construction drawings and the technical data received by the telepaths - no matter where they came from - were so precise that the most fantastic idea ever conceived by man was born: the building of a machine for flight to the beyond! The concept of an "other science" mentally matured (today one would use the term "alternative forms of energy").

It was three years before the project got under way. In that first phase of an "other technology" or an "other science" Dr **W. O. Schumann**, a member of the Thule and Vril Societies, gave a lecture at the Faculty of Science in Munich.

## Here is an extract

Everywhere, two principles determine events: light and darkness, good and bad, creation and destruction, like the positive and negative in electricity. It is always Either - Or!

- These two principles, designated concretely as creative and destructive principles, also determine our technological methods.[...]
- The destructive principle is the work of Satan, the creative principle is the work of God.[...]
- All technology based on the principle of explosion or of combustion may be called satanic technology. The coming New Age will be the age of a new technology, positive and divine![...]  
(extract from the secret archives of the SS).

## Implosion Technology

At the same time, the scientist **Viktor Schauberger** (right) was working on a similar project.

He was using the teaching of Johannes Kepler who was in possession of the secret doctrine of the Pythagoreans, held and kept secret by the Templars. This concerned knowledge of [implosion](#) (in this case, meaning the utilization of the potential of inner worlds in the outer world).

Hitler and all the other members of the Thule and Vril Societies knew that the divine principle is always creative, that is to say, constructive. A technology which, by contrast, relies on explosion is therefore destructive, opposed to the divine principle. So one would wish to create a technology relying on implosion.

Schauberger's oscillation teachings (the principle of the harmonic series = monotone) is part of the understanding of implosion. Put very simply: implosion instead of explosion!

By means of the energy trajectories of the monotone and implosion technology one can penetrate into the domain of antimatter and in this way one can dissolve gravity.



## Saucer-shaped craft

The first saucer-shaped craft was built in the summer of 1922, its drive based on implosion technology (the machine for flight to the beyond).

It consisted of a disc of 8m diameter, surmounted by a parallel disc of 6.5m diameter, with another disc of 6m diameter underneath. These three discs had a hole of 1.80m through their centers, where the 2.40m high propulsion unit was mounted. At the base, the central body terminated in the form of a cone. In this cone was a kind of pendulum for stabilization of the device.

The lower and upper discs turned in opposite directions to create a rotating electromagnetic field.

The performance of this first flying disc is unknown. It was experimented on for two years before being dismantled and stored at the Messerschmidt works at Augsburg. The financing for this project can be found in the accounts of several industrial companies, mentioned under the code JFM. It is certain that the Vril mechanism is descended from the machine for flight to the beyond but it has been indexed as the Schumann SM levitator.

In principle, the machine for flight to the beyond had to engender an extremely strong field around itself and its immediate vicinity which made all of the surrounding space, comprising that of the machine and its occupants, a microcosm completely independent from our cosmos.

At its maximum power, this field would be completely independent from all the forces and influences of our Universe, such as gravitation, electromagnetism, radiation, as well as any kind of matter. It could move at will in any gravitational field without one sensing it, or feeling forces of acceleration.

In June 1934, Viktor Schauberger was invited by Hitler and the highest representatives of the Vril and Thule societies and worked, from then on, with them. The first German UFO was developed in June 1934. Under the direction of Dr W. O. Schumann the first experimental [circular aircraft RFZ 1](#) was developed at the Arado aircraft factory in Brandenburg.

Even though its first flight was also its last, it rose vertically to a height of about 60m but then started to tumble and dance in the air for several minutes.

The Arado 196 tail unit which was supposed to guide the device proved to be completely ineffective. With great difficulty the pilot Lothar Waiz succeeded in bringing it back to the ground, escaping from it, and getting away in time, because the device started to spin like a top before it overturned and completely broke into pieces. That was the end of the RFZ 1 but the beginning of [the VRIL flying machines](#).

The RFZ 2 was finished at the end of 1934, it had a Vril drive and a magnetic impulsion flying system. Its diameter was 5m and had the following characteristics: the contours of the device became blurred as it gained speed, and it lit up with different colors, a well known characteristic of UFOs.

Depending on the propulsive force, it became red, orange, yellow, green, white, blue or violet. It was able to operate, and it had a remarkable destiny in the year 1941. It was used as a long range reconnaissance aircraft during the battle of England.

The standard German ME 109 fighters had proved themselves unfit for transatlantic reconnaissance flights because of their short range.

It was photographed at the end of 1941 over the south Atlantic while on the way to the auxiliary cruiser Atlantis which was in Antarctic waters. It could not be used as a fighter aircraft for the following reason: because of its impulsion flying system, the RFZ 2 could only make changes in direction of 90°, 45°, or 22.5°. Unbelievable, some of you will think, but it is exactly these right-angle flight changes that are characteristic of UFOs.

After the success of the small RFZ 2 as a long range reconnaissance aircraft, the Vril Society acquired its own testing ground in Brandenburg. The [VRIL 1 Hunter](#), a lightly armed flying disc, flew at the end of 1942. It was 11.5m in diameter, had a single seat, and it had a Schumann levitation drive and a magnetic field impulsion flying system.

It reached speeds of 2900 to 12,000 km/h, could accomplish right angle direction changes at full speed without harming the pilot, was unaffected by the weather, and was perfectly capable of spaceflight. Seventeen examples of the VRIL 1 were built, there were also several variants with two seats, equipped with glass domes.

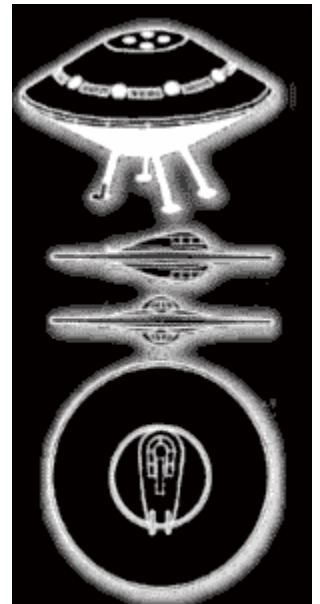

At the same time, a V-7 project was developed. Several flying discs carried this name but they had conventional jet propulsion. According to Andreas Epp the RFZ 7 was created, which combined a levitating flying disc with jet propulsion.

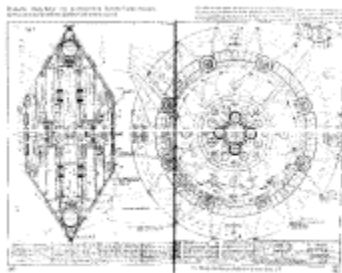

The firms of Schriever-Habermohl and Miethe Belluzo worked on it. It was 42m in diameter but it crashed while landing in Spitzbergen. Later, however, an RFZ 7 built in the same way was photographed outside Prague.

According to **Andreas Epp**, it was to be equipped with nuclear warheads to bomb New York.

In July 1941, Schriever and Habermohl built a circular aircraft which took off vertically, with jet propulsion, but which had, however, some severe deficiencies.

However another electrogravitational flying spinning-top with tachyon drive was developed which was more successful. Then came the RFZ 7 T, built by Schriever, Habermohl and Belluzo, which was fully functional. However, compared to the Vrill and Haunebu discs, the V-7 flying discs were children's toys.

Within the SS there was a group working on the production of alternative energy: the Research Group IV of the Black Sun = SS-E-IV whose main objective was to make Germany independent of foreign crude oil.

The SS-E-IV developed the Thule mechanism, later called the **Thule Tachyonator** from the Vrill mechanism and from the tachyon converter of Captain Hans Coler.

In August 1939 the first RFZ 5 took off. It was a fairly heavily armed flying spinning-top with the strange name Haunebu 1.

It had a crew of eight men, measured 25m in diameter, at first reaching a speed of 4800 km/h, and later, up to 17,000 km/h. It was equipped with two long range 60mm cannons (KSK) mounted in rotating turrets, and four MK 106's and had a moderate ability for spaceflight.

At the end of 1942, the Haunebu II was likewise ready. Its diameter varied from 26 to 32m, its height was from 9 to 11m.

It could transport a crew of 9 to 20 persons. Driven by a *Thule Tachyonator*, it reached 6000 km/h in the periphery of Earth. It was suitable for spaceflight and had a range of 55 flying hours. Plans already existed for the large 120m diameter space craft Vrill 7, able to transport entire companies.

Shortly afterwards, the 71m diameter Haunebu III was constructed, the most splendid example of all.

It flew and was even filmed. It could transport 32 persons, its flight duration was more than eight weeks and it reached a speed of at least 7000 km/h (and according to documents from the secret archives of the SS, it could reach 40,000 km/h).

Virgil Armstrong, ex-member of the CIA and former Green Beret, states that German flying machines during World War 2 could land and take off vertically and fly at right angles. They reached 3000 km/h and were armed with laser cannons (probably the KSK, a long range cannon) which could penetrate 4 inch thick armour plating.

Professor **J. J. Hurtak**, ufologist and author of [The Keys of Enoch](#), said that the Germans were in the process of constructing what the Allies designated miracle weapons systems.

Hurtak had in his hands documents mentioning..

1. the construction of Peenemünde, a city for experimentation with machines teleguided into space.
2. the bringing together of the best German technicians and scientists These documents also mentioned the existence of the so-called foo fighters (balls of fire).

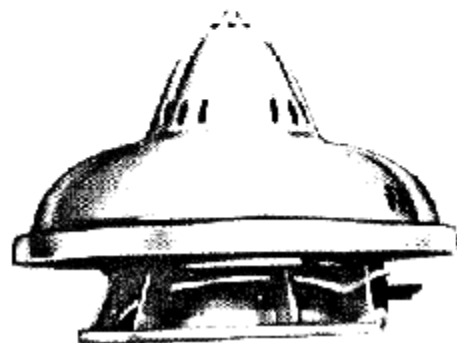

The CIA and the British Secret Services already knew, in 1942, of the construction and deployment of such flying objects, but they did not appreciate their true merit.

In fact the Allies designated under the name foo fighters all kinds of luminous German flying craft. Two inventions correspond particularly to what were called foo fighters: the "flying turtles" and the "soap bubbles."

The two had nothing to do with each other, but the Allies wrongly associated them. The "flying turtle" was conceived by the research group SS-E-IV at Wiener Neustadt. Its shape was reminiscent of a turtle's shell. It was an unmanned flying probe which would upset the electrical ignition systems of enemy armaments. This probe was also equipped with sophisticated weapons, Klystron tubes called death rays by the SS. But this sabotage by cutting off ignition did not work perfectly at first. Development of this technique continued later.

Anyone who has already seen a UFO can confirm that this ignition cutting, i.e. the shutting down of electrical systems, is one of the typical characteristics of UFOs when they appear.

Wendell C. Stevens, a US Air Force pilot during World War 2 said that the foo fighters were sometimes grey-green or red-orange, that they approached up to 5m from the aircraft and that they stayed in that position. It was not possible to get rid of them, even when shot at from underneath, and sometimes the flights were obliged to turn back or to land.

As for the "soap bubbles" often called foo fighters, these were in fact simple balloons, in the interior of which were fine metal spirals to jam the radars of the enemy aircraft. Their effectiveness was probably minimal, apart from psychological intimidation.

At the beginning of 1943, planning began for a spaceship in the shape of a cigar, the Andromeda craft (click below image), which was to be built at the Zeppelin works (139m long).

It would transport several saucer shaped spacecraft for (interstellar) long duration flights.

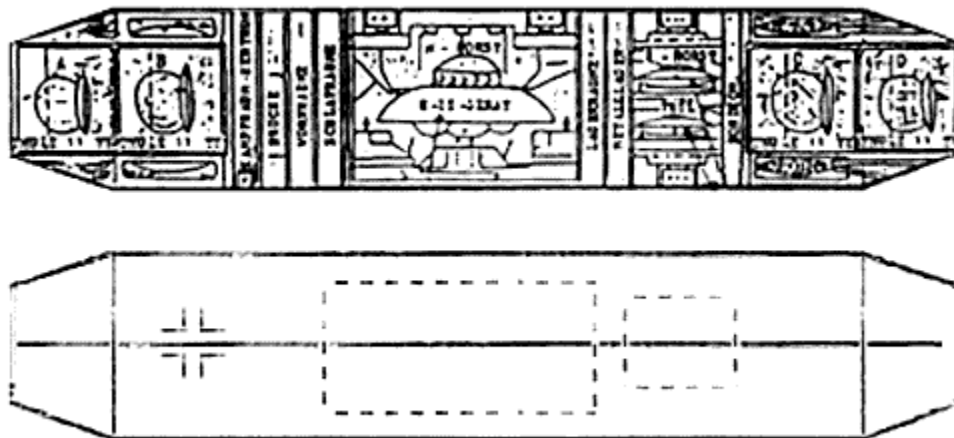

[click image to enlarge](#)  
The Andromeda Craft

An important meeting of the Vril Society took place around Christmas 1943 at Kolberg, a seaside resort by the North Sea, which the mediums Maria and Sigrun attended.

The principal subject was the Aldebaran Enterprise. The mediums had received precise information about the inhabited planets orbiting the Aldebaran sun, and a voyage was planned to go there. On 2 January 1944, Hitler, Himmler, Künkel

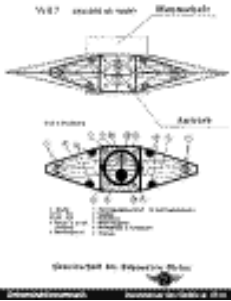

and Dr Schumann (both of the Vril Society) met to talk about this Vril project. They wished to travel by means of a large spacecraft, the Vril 7 (click image left), to Aldebaran, through a dimensional channel.

According to Ratthofer, the first test flight in a dimensional channel took place in winter 1944. The craft must have avoided a disaster by a narrow margin, because from photos of the Vril 7 taken after its return, it looked as though it had been travelling for a century.

The exterior surface of the cabins appeared very worn and there was damage in many places.

On 14 February 1944, the test pilot Joachim Roehlike test flew at Peenemünde the supersonic helicopter built by Schriever and Habermohl under the name of project V 7 which was fitted with twelve BMW 028 turboprop engines. Its speed in vertical climb was 800m per minute, it reached a height of 24,200m and its speed in horizontal flight was 2200 km/h.

It could also be propelled by non conventional energy. However, it could never be used, because Peenemünde was bombed in 1944 and its transfer to Prague proved to be of no use since that city was occupied by the Americans and the Russians well before the flying discs could be used.

When they occupied Germany at the beginning of 1945, the British and the Americans discovered in the secret archives of the SS, among other things, photos of the Haunebu II and the Vril I as well as the Andromeda craft.

In March 1946 President Truman acted so that the Naval command of the USA gave permission to collect German material in order to experiment with this high technology. Under [Operation Paperclip](#) German scientists were brought secretly to the USA. Among them were Viktor Schauberger and Wernher von Braun.

Here we summarize briefly the developments which should be given in a series:

- The first project was carried out under the direction of Professor Dr W. O. Schumann of the Faculty of Science at Munich. In this project, up to the beginning of 1945, 17 flying discs of 11.5m diameter were allegedly constructed, which accomplished 84 flight tests, the so-called [Vril 1 Hunters](#).
- In April 1945, at least a [Vril-7 and a large Vril-7 named Odin](#) took off from Brandenburg for Aldebaran, after the entire test area had been blown up, taking a group of Vril scientists and Vril lodge members. The second project was led by the Research Group IV of the SS who had constructed, up to the beginning of 1945, three types of space-going bell shaped spinning-tops of different sizes:
- The Haunebu I, 25m in diameter, in two examples, tested 50 times (flight speed about 4800 km/h).
- The Haunebu II, 32m in diameter, in seven examples, tested 100 times (flight speed about 6000 km/h). The Haunebu II was in fact intended for series production. A tender was let to the aircraft companies Dornier and Junkers. At the end of March 1945, Dornier landed the contract. The official designation of these heavy flying spinning-tops should be DOSTRA (Dornier Stratospheric Aircraft).
- The Haunebu III, 71m in diameter, in only one example, flew at least 19 times (flight speed about 7000 km/h).

There were plans for the Andromeda craft (see above image), a 139m spaceship which could contain one Haunebu II, two Vril I's and two Vril II's.

Furthermore, there are documents attesting that the large version of the Vril-7 was finished at the end of 1944, and after testing, it made several flights within the Earth's orbit, which were kept secret:

1. Landing near the Mondsee lake in the Salzkammergut with diving tests to pressure-test the fuselage.

2. From March to April 1945 the Vril-7 was probably stationed at the Alpine Fortress for security and strategic reasons. From there, it took off for Spain where important personalities of the Reich had fled as refugees, to take them to South America and to [Neuschwabenland](#) and to keep them secure in secret bases which the Germans had constructed there during the war.

3. Immediately afterwards, the Vril-7 is supposed to have made a secret flight to Japan, but nothing more is known about it. What happened to these space ships after the war? The production of the Haunebu II in a very small series cannot be excluded. Different photos of UFOs whose construction, after 1945, showed a typically German appearance, suggest this possibility.

Some say that some of these machines would have been sunk in the Mondsee lake in upper Austria, others think that they would have been taken to South America, or that they were transported there in pieces. It is certain that even if they were not necessarily taken to South America, new devices were built there from construction drawings.

They were flown, and an important part of this technology was used in 1983 in the Phoenix Experiment, preceded by [the Philadelphia Experiment](#) of 1943.

(This concerned US Naval experiments on teleportation, materialization and time travel which were more successful than anyone would have imagined in their wildest dreams. There is enough material here for another book, but that would divert us from our subject. See the bibliography).

In 1938 a [German expedition to the Antarctic](#) took place, led by the aircraft carrier Schwabenland.

The Germans claimed 600,000 square kilometers of territory which they named Neuschwabenland. It was a region free of ice, with mountains and lakes. Later, entire fleets of type 21 and 23 submarines travelled to Neuschwabenland. To this day, more than a hundred German submarines are missing.



Among other things, they were equipped with the Walter snorkel which enabled them to remain submerged for several weeks.

One may suppose that they went to Neuschwabenland with flying discs in separate pieces, or at least with the construction drawings.

One may suppose also, since the test flights were successful, that directly after the end of the war the flying discs were produced there. This supposition may appear daring, but many important indicators allow us to imagine that this is what happened.

The question arises: Why did the Allies under Admiral E. Byrd [invade the Antarctic in 1947](#)? If it was only an expedition, why did Byrd have at his disposal 4000 soldiers, a warship, a fully equipped aircraft carrier and a full re-supply system?

He had eight months available, however he was forced to withdraw after eight weeks, after having suffered large losses of aircraft. The exact number was never made public. What had happened? Admiral Byrd later explained to the press:

"It is bitter to realize that in the case of a new war we will have to cope with the attacks of aircraft which can fly from one pole to the other."

He also let it be known that there was an advanced civilization down there which, together with the SS, was served by an advanced technology.

In his book Time Machines where he asks, among other things, what happened to the Haunebu, Norbert Jürgen-Ratthofer writes:

From May 1945, the Haunebu I, II and III space-going spinning-tops and even the Vril 1 space-going flying discs disappeared, at first without trace.

[...]

In this context, it is extremely interesting to know that the Haunebu III of the German Reich, after its nineteenth test flight, was flown on a space expedition to Mars, taking off on 20 April 1945 from Neuschwabenland which was officially at that time an immense territory of the German Reich in East Antarctica.

What resulted, we do not know. [...]



A year later, in 1946, innumerable luminous objects of unknown but obviously artificial origin were seen above Scandinavia, provoking great agitation amongst the Allies in the East as in the West.

Another year later, in 1947, and continuing into the 1950's, a constantly rising number of luminous flying objects suddenly appeared above North America. Certainly they were piloted by intelligent beings, most often they were round, disc or bell shaped. There were also sometimes unidentified flying objects in the shape of cigars. There are writers who say that usually these UFOs do not resemble those made by the German Reich.

Well documented photographic material proves that particularly the Haunebu II version was seen, and even very often, since 1945.

If you have become interested in the technical world of UFOs you will be able to verify that among the cases where there has been personal contact with UFO occupants, there is a particularly high percentage of very attractive beings of the Aryan race, blond with blue eyes, who spoke either fluent German or another language with a German accent (for insiders we mention the cases of Adamski in 1952, Cedric Allingham in 1954, and Howard Menger in 1956).

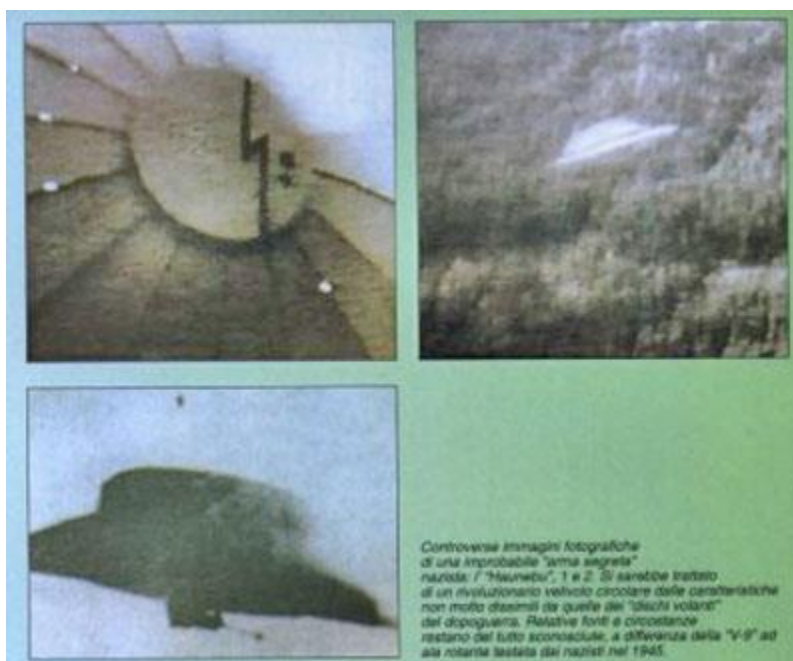

We also recall that color photos exist of a manned flying disc which landed and immediately took off again, and which was marked with two crosses, a Balkenkreuz and a swastika.

These photos were taken in the 1970's by a night watchman in West Germany. A very good dossier of photos and films exists on the flying machines mentioned above, as for example the 60 minute documentation "[UFO Secrets of the Third Reich](#)"; (MGA Austria/Royal Atlantis Film GmbH). Likewise the dossier of the American Vladimir Terziski who, during the UFO conference in September 1991 in Phoenix Arizona showed slides for three hours and showed photos of German saucers, drawings of their construction, and of subterranean German bases.

The Italian Air Force Commander Renato Vesco's book is also very interesting, as is that of Rudolf Luser:  
"Die deutschen Waffen und Geheimwaffen des 2. Weltkrieges und ihre Weiterentwicklung," J. F. Lehmanns Verlag, Munich, 1971  
[see earlier English edition "German Secret Weapons of the Second World War and their Further Development," Neville Spearman, London, 1959].

Do you now understand why the mass media dismisses everything about UFOs as fraud? Taking this German background into account, the world of the press and the media controlled by the Illuminati, by means of the Anglo-American-Zionist lobby is prepared to invest enormous sums to prevent citizens from investigating in this area.

The question that arises now is: from where did the German secret societies Thule and Vril get the indispensable knowledge for the construction of these flying machines? From where did they get their understanding of genetic engineering, in which the Germans were likewise well ahead of other nations?

According to the statements of Herbert G. Dorsey and other researchers, they were helped not only by the telepathic contacts with extraterrestrials in providing construction drawings, but also by studying the intact drive of a non-terrestrial saucer which crashed in the Black Forest in 1936. But there is practically no evidence of that event, nor any eyewitnesses still alive.

However, evidence exists in the USA, even a lot of it. Because at the same time the Americans recorded a series of objects which crashed to the ground, and which could not be kept completely secret.

We shall revisit these later. Returning to the political, while [I.G. Farben](#) supported Hitler, its cartel partner Standard Oil ([Rockefeller](#)) aroused the people against the Nazis. Similarly, the Ford Motor Company made armaments for the American Army, but at the same time built military vehicles for the Nazis in Germany. Ford and Opel (a branch of General Motors which is controlled by J. P. Morgan) were the two largest tank manufacturers in Hitler's Germany.

No matter who won the war, the multinationals were winners from the start.

Many enterprises operated on the same principle during World War 2. Why is there nothing about this in the schoolbooks or encyclopaedias? One of the reasons is as follows: in 1946 [the Rockefeller foundation](#) distributed USD139,000 to present an official version of World War 2 to the public, which concealed all aid given by American bankers for building the Nazi regime, and which was also silent about the mystical and occult ideology of that regime.

One of the principal donors was Rockefeller's Standard Oil Corporation.







Vril-7 in seiner letzten Mission. Die Geschwindigkeit ist abgelesen. (Nur ab 24 bis 26 Uhr abends) (Nur ab 24 bis 26 Uhr abends) (Nur ab 24 bis 26 Uhr abends) (Nur ab 24 bis 26 Uhr abends) (Nur ab 24 bis 26 Uhr abends)

148

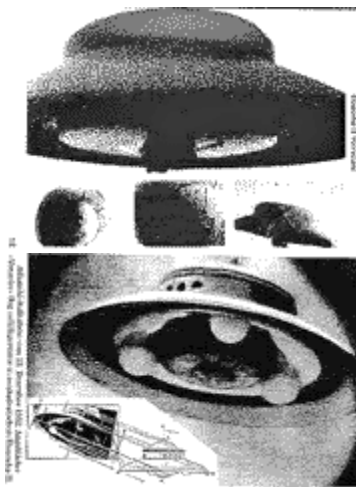

Das Vril-7 in seiner letzten Mission. Die Geschwindigkeit ist abgelesen. (Nur ab 24 bis 26 Uhr abends) (Nur ab 24 bis 26 Uhr abends) (Nur ab 24 bis 26 Uhr abends) (Nur ab 24 bis 26 Uhr abends) (Nur ab 24 bis 26 Uhr abends)

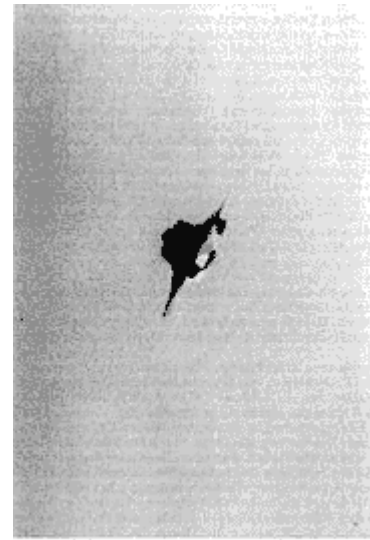

VRILODIN, April 1945 mit unklar erkennbaren Doku-Strahlungsschatten.

## Return to The Vril Society Return to German Disc Aircrafts - 1922-1945 and Beyond

### Menu



- [Introduction to German Flying Discs](#)
- [Document's Photo Gallery](#)
- [German Secret Technology - Could There Have Been A Link To Some Early UFO Reports?](#)
- [Photo Report of Information Found in Declassified Files](#)
- [Secret Flying Discs of The Third Reich \(1922-1945\) - Main File](#)

### Additional Information







- [Cosmología de la India Revisada a La Luz de Los Hechos Actuales](#)
- [German Moon Base](#)
- [Half A Century of The German Moon Base \(1942 - 1992\)](#)
- [India Cosmology Revisited in The Light of Current Facts](#)
- [La Sociedad Thule](#)
- [Los "Ovnis del Reich" - Nazis en La Luna - La Prodigiosa Tecnología del Tercer Reich](#)
- [Nazi UFOs - Another View on the Matter](#)
- [Secrets of The Third Reich](#)
- [The Aldebaran Mystery...?](#)
- [The Coanda Effect - Flying Saucers Research and Development](#)
- [The UFOs of Nazi Germany](#)
- [The "Vril-Gesellschaft" Or Not All Good Comes From Above - from 'Secret Societies and Their Power in The 20th Century'](#)
- [UFO's and The Occult Reich](#)
- [Vril Society - "The Yellow Book" no 5](#)

### Books-Treaties

- [A Guide To German Flying Disks of WW-2 - by Henry Stevens](#)
- [Germany's Secret Weapons in World War II - by Roger Ford](#)

-  - [Los Ovnis Del III Reich - El Ultimo Batallon De Hitler](#) - por Paulo E.F. Lopez
  - [Reich of The Black Sun - Nazi Secret Weapons and The Cold War Allied Legend](#) - by Joseph P. Farrell
  -  - [The Hunt for Zero Point](#) - Inside the Classified World of Antigravity Technology - by Nick Cook
- 

### Multimedia

-  - [German Area 51](#)
  - [Hitler's Flying Saucers](#)
  - 
  -  - [Hitler's Flying Saucers - A Guide to German Flying Discs of WWII:](#)  
[Part 1](#)    [Part 2](#)    [Part 3](#)
  -  - [Nazi UFO Secrets of WWII](#)
  -  - [Secrets of The 3rd Reich - Disk-Shaped Flying Objects](#)
  -  - [Secrets of The Third Reich II - Nazi Bases in Antarctica](#) - Russian UFO Documental May 2006
  -  - [UFO Secrets of WWII](#) - German Flying Saucers
- 

### Related Reports

- [Hi-Tech/Top Secret Military Weapons](#) - **Main File**
- [La Teoria De La Tierra Hueca](#) - **Main File**
- [Project Paperclip](#) - **Main File**
- [The Majestic Documents](#) - **Main File**
- [The Thule Society](#) - **Main File**
- [The Vimanas](#) - **Main File**
- [The Vril Society](#) - **Main File**

[http://www.bibliotecapleyades.net/esp\\_ufoaleman.htm#inicio](http://www.bibliotecapleyades.net/esp_ufoaleman.htm#inicio)