

# [The Tom Bearden Website](#)

## **TOWARDS A NEW ELECTROMAGNETICS PART 4: VECTORS AND MECHANISMS CLARIFIED**

by Lt. Col. T.E. Bearden (retd.), 1983  
Copyright

---

[Title Page](#)

[Foreword](#)

1. [TOWARDS A NEW ELECTROMAGNETICS - ACKNOWLEDGEMENTS](#)
2. [OUTLINE](#)
3. [CHARACTERISTICS OF SELECTED CONCEPTS](#)
4. [QUOTE FROM NIKOLA TESLA](#)
5. [FORCE BETWEEN TWO LIKE CHARGES](#)
6. [REPETITIONS LEAD TO THE VECTOR "FIELD" CONCEPT](#)
7. [A SCALAR HAS A HIDDEN \(VIRTUAL\) VECTOR SUBSTRUCTURE](#)
8. [SCALAR AND VECTOR SUBSTRUCTURES](#)
9. [SUPERPOSITION DOES NOT ELIMINATE THE VIRTUAL SUBSTRUCTURE](#)
10. [PHYSICAL VECTORS](#)
11. [THE FOUR VECTORS OF PHYSICS](#)
12. [FORCE DEFINITION](#)
13. [FORCE IS AN EFFECT, NOT A CAUSE](#)
14. [FORCE AND  \$\ddot{E}\$ -FIELD DO NOT EXIST IN VACUUM](#)
15. [COROLLARIES](#)
16. [ENERGY IS DERIVED, NOT FUNDAMENTAL](#)
17. [EXISTENCE IN, AND PASSAGE THROUGH, TIME](#)
18. [SOME IMPLICATIONS](#)
19. [CONSERVATION OF ANENERGY \(AE\): \(AN EXPANDED CONSERVATION LAW\)](#)
20. [FREE ENERGY IS ALLOWED](#)

21. [SCALAR POTENTIAL CAN FORCE THE RELATIVISTIC CASE](#)
22. [SCALAR STRESS WAVE \(Ö-WAVE\) \(TESLA WAVE\)](#)
23. [SCALAR Ö-WAVE PRODUCTION](#)
24. [A SIMPLIFIED CHARGED PARTICLE](#)
25. [A CHARGED PARTICLE IS A SPECIAL KIND OF "SPRAY NOZZLE"](#)
26. [AN OBSERVABLE CHARGED PARTICLE IS DIRECTLY CONNECTED TO VIRTUAL PARTICLE FLUX VACUUM](#)
27. [SPIN COUPLES VACUUM TO PARTICLE](#)
28. [ELECTRON PRECESSION \(SIMPLIFIED\)](#)
29. [VACUUM/SPACETIME IS PURE VIRTUAL PARTICLE FLUX \( \$\emptyset\_0\$ \)](#)
30. [VACUUM IS:](#)
31. [GRADIENT OF ELECTROSTATIC POTENTIAL](#)
32. [IN A  \$\nabla\emptyset\$ , A CHARGED PARTICLE MOVES ITSELF](#)
33. [ELECTROMAGNETIC WAVES IN ELECTRON GAS IN A CONDUCTOR](#)
34. [ELECTROMAGNETIC WAVES IN VACUUM](#)
35. [DETECTION OF TRANSVERSE AND LONGITUDINAL WAVES](#)
36. [CREATING A "RIVER" OF ANENERGY](#)
37. [A 2-WIRE SYSTEM IS CONSERVATIVE](#)
38. [A HOLLOW CHARGED SPHERE](#)
39. [ONE-WAY GATE VALVE](#)
40. [SIMPLE FREE ENERGY MOTOR](#)
41. [THE TRANSLATOR](#)
42. [TRANSVERSE WAVE INTERFERENCE](#)
43. [LONGITUDINAL WAVE INTERFERENCE \(SCALAR WAVES\)](#)
44. [CREATING ENERGY AT A DISTANCE](#)
45. [NONLINEARITIES CAUSE SHIFTING \(PARTIAL TRANSLATION\)](#)
46. [THE SCALAR AURA.](#)
47. [VIRTUAL FLUX AND MAGNETIC FIELD \(LINEAR CASE\)](#)
48. [PRODUCING MAGNETIC MONOPOLES](#)
49. [BREAKING METAL WITH MAGNETIC MONOPOLES](#)
50. [CREATING AN INERTIAL FIELD \(ANTIGRAVITY\)](#)
51. [EFFECTS ON HUMANS](#)
52. [INITIATING SPECIFIC BIOLOGICAL EFFECTS](#)
53. [GROUND-TO-AIR USE](#)

54. [TACTICAL AIR-TO-GROUND USAGE](#)
55. [INTEGRATED WEAPONS DISPLAY \(MODIFIED JAMMER\)](#)
56. [RADAR INVISIBILITY](#)
57. [NETWORK OF VIRTUAL TRANSMITTERS](#)
58. [CONCLUSION](#)

[\*\*Return to Homepage\*\*](#)

TOWARD A NEW ELECTROMAGNETICS

PART 4: VECTORS AND MECHANISMS CLARIFIED

(©) 1983 T. E. Bearden

All rights reserved.

Delivered to the 1983 Annual Conference

of the

U. S. Psychotronics Association

July 20-24, 1983

at the

University of Portland

Portland, Oregon

[The Tom Bearden  
Website](#)

--FOREWORD --

This paper is an adaptation of the oral/visual presentation given by the author at the 1983 Annual Conference of the U. S. Psychotronics Association on Saturday, July 23, 1983.

The presentation was delivered directly from the vugraphs alone, and not from a formal, written text.

The title of the presentation at the conference was "New Electromagnetics: Where the 'Old Math' Took the Wrong Turn."

As originally conceived, the lecture was to be given in a single period of some 45 minutes and cover only the first part of this paper, the clarification of the vector concept in physical theory. The Symposium director so graciously scheduled two periods instead, allowing time to present additional material further clarifying vector and scalar waves, and to present a variety of unusual physical mechanisms that apply the concepts.

After the conference, the author prepared this paper directly from the same slides, in the same order. However, no attempt was made to match the words in this paper to the words actually delivered in the formal presentation. The gist of the two, however, are the same -- except that, in the conference lecture, the author covered (as an aside) some important additional material: (1) the nature of what actually occurs in an "electrical ground," and (2) the author's explanation of the theory of Tesla's magnifying transmitter.

An audio tape and a videotape of the author's USPA presentation were made by the conference officials. Copies are available at nominal cost from Mr. Robert Beutlich, Secretary/Treasurer, U. S. Psychotronics Association, 3459 Montrose Avenue, Chicago, Illinois 60618, U.S.A., phone (312) 478-7715.

[The Tom Bearden  
Website](#)

SLIDE 1.

## **TOWARD A NEW ELECTROMAGNETICS**

**© 1983 T.E. BEARDEN**

**ALL RIGHTS RESERVED**

### ACKNOWLEDGEMENTS

I would like to express my deep appreciation to two of my fellow colleagues, Dr. William Tiller and Mr. Frank Golden, for many fruitful hours of discourse and interchange on these and related subjects.

Also, I wish to thank the Association of Distinguished American Scientists (A.D.A.S.) for support and assistance in the long and arduous struggle to revise the basic foundations of electromagnetics and mechanics.

[Next Slide](#)

SLIDE 2.

## OUTLINE

---

- **MAIN BRIEFING**
  - > **TRANSLATOR EFFECTS**
  - > **POTENTIAL WEAPONS**
  - > **INCIDENTS**
  - > **CONCLUSION**
  
- **HISTORICAL BACKGROUND**
  - > **TESLA/MORAY**
  - > **WWII AND AFTER**
  
- **ELEMENTS OF THE EMERGING THEORY**
  - > **LONGITUDINAL/ TRANSVERSE WAVES**
  - > **VACUUM/MASS EFFECTS**
  - > **FLAWS IN VECTOR THEORY**
  - > **IMPLICATIONS**

This presentation is one part of a three part presentation, consisting of the main briefing on physical effects, the historical background, and the elements of the emerging new electromagnetics.

In this present briefing I will not cover the historical background. Instead, first I will address the concepts of the new theory, and then I will give an abbreviated main briefing, including some weapon aspects. I will present one simple free energy motor and show how it works, and where it gets its energy.

Much of this material I have known for some time, but have hesitated to release it because it enables one to develop -- in a fairly straightforward manner -- weapons and beams (ray) systems that can disable electronics, computers, communications, and people. Anyone

handy in electronics, who has a few thousand dollars and access to bench equipment and an electronics parts supply house, can develop these weapons in his or her basement workshop. But because certain very radical elements in this country already know some of this information and may plan to utilize such devices in criminal activities, I am openly releasing the information as a warning, to be prepared.

Of course there are many good things that can be developed with this technology, including machines to heal a remarkable variety of ailments and illnesses. I strongly urge everyone to use this information wisely and only to benefit other human beings. There exists a cosmic or karmic law for those who misuse it against their fellow persons; if one does that, one will assuredly suffer the consequences.

Also, I strongly urge the development of Western defenses against the Soviet strategic and tactical weapons; already developed utilizing these principles. Unless the West wakes up to the extreme urgency of this task, in the near future we may be overwhelmed in short order by a much harsher, dictatorial system. If that should happen, it will plunge the human race into a new dark ages far more terrible than that dark period in history following the fall of Rome.

These are the final times, and this is the beginning of the final technology. The ability to directly engineer physical reality itself has been laid in our laps. Pandora's box is already spilled open, and there is no longer any stopping the new technology.

Let us prepare, then, for that which is to come.

With these introductory remarks, let us now turn to the main presentation.

[Next Slide](#)



[The Tom Bearden  
Website](#)

SLIDE 3.

**CHARACTERISTICS OF SELECTED CONCEPTS**

CONCEPT	CHARACTERISTIC
<ul style="list-style-type: none"> <li>• <b>ENERGY</b></li> <li>• <b>ANENERGY</b></li> <li>• <b>PRESENT "CHARGE"</b></li> <li>• <b>TRUE CHARGE</b></li> </ul>	<p><b>FLOW OF OBSERVABLE MASS PARTICLES</b></p> <p><b>FLOW OF VIRTUAL PARTICLES</b></p> <p><b>VIRTUAL PARTICLE FLUX TIED TO OBSERVABLE MASS PARTICLES</b></p> <p><b>VIRTUAL PARTICLE FLUX WITHOUT MASS</b></p>
<ul style="list-style-type: none"> <li>• <b>FLUX</b></li> <li>• <b>FLOW</b></li> <li>• <b>CURRENT</b></li> </ul>	<p><b>MULTI-DIRECTIONAL FLOW THROUGH A POINT</b></p> <p><b>UNI-DIRECTIONAL MOVEMENT OF A FLUX [GRADIENT]</b></p> <p><b>UNI-DIRECTIONAL GRADIENT OF A [USUALLY CONSTRAINED] FLUX</b></p>

On this slide I show some fundamental defining characteristics of energy, "charge" or charged mass as presently in the theory, flux, flow, and current. These fundamental concepts are often somewhat confused in the literature.

Particularly note that the concept of energy, being tied to "the capacity to do work," is specifically tied to the concept of mass. Eventually, energy must be expressed in terms of moving masses -- specifically, in accelerating or decelerating masses.

I introduce the term "anenergy" here, specifically in relation to

the concept of a virtual particle. An energy is roughly equivalent to the present idea of "virtual energy,"

except it more precisely implies the flow or flux of virtual particles.

We also redefine charge as virtual particle flux, in order to remove the present error in EM theory where "charge" always implies a charged mass. The electrostatic scalar potential,  $\phi$  ( $\emptyset$ ), then merely becomes the intensity of the massless charge -- that is, the intensity of the virtual particle flux -- at a point. Let me point out, however, that in the new view this "point" is always in n-dimensional space, where n is equal to or greater than four. The present 3-space formulation of  $\emptyset$  is thus a highly special case.

[Next Slide](#)

## [The Tom Bearden Website](#)

SLIDE. 4

### **QUOTE FROM NIKOLA TESLA:**

---

**"THE HERTZ WAVE THEORY OF WIRELESS TRANSMISSION MAY BE KEPT UP FOR A WHILE, BUT I DO NOT HESITATE TO SAY THAT IN A SHORT TIME IT WILL BE RECOGNIZED AS ONE OF THE MOST REMARKABLE AND INEXPLICABLE ABERRATIONS OF THE SCIENTIFIC MIND WHICH HAS EVER BEEN RECORDED IN HISTORY."**

**Nikola Tesla**  
**"The True Wireless,"**  
**The Electrical Experimenter**

One of the things we will find is that Hertz or transverse electromagnetic waves are strictly mass waves in a charged mass particle medium.

For example, transverse EM waves do not, and CAN not, exist in vacuum. Vacuum EM waves are longitudinal waves of compression and rarefaction. What is compressed and rarified is the virtual particle flux that comprises vacuum itself. Vacuum EM waves in this virtual flux are just like sound waves in air -- in the flux of molecules and atoms that comprise the atmospheric gas.

Nikola Tesla, of course, knew this and he frequently pointed out the falsity of the accepted transverse wave theory. Here is one Tesla quote, for example, taken from The Electrical Experimenter. (PAUSE)

Almost every scientist -- even the "Tesla bugs" -- have thought Tesla wrong in his adamant opposition to the idea of Hertzian waves in the vacuum.

As we shall see, Tesla was right and all the present scientists and textbooks are wrong .

[Next Slide](#)

# [The Tom Bearden Website](#)

SLIDE 5.

## FORCE BETWEEN TWO LIKE CHARGES

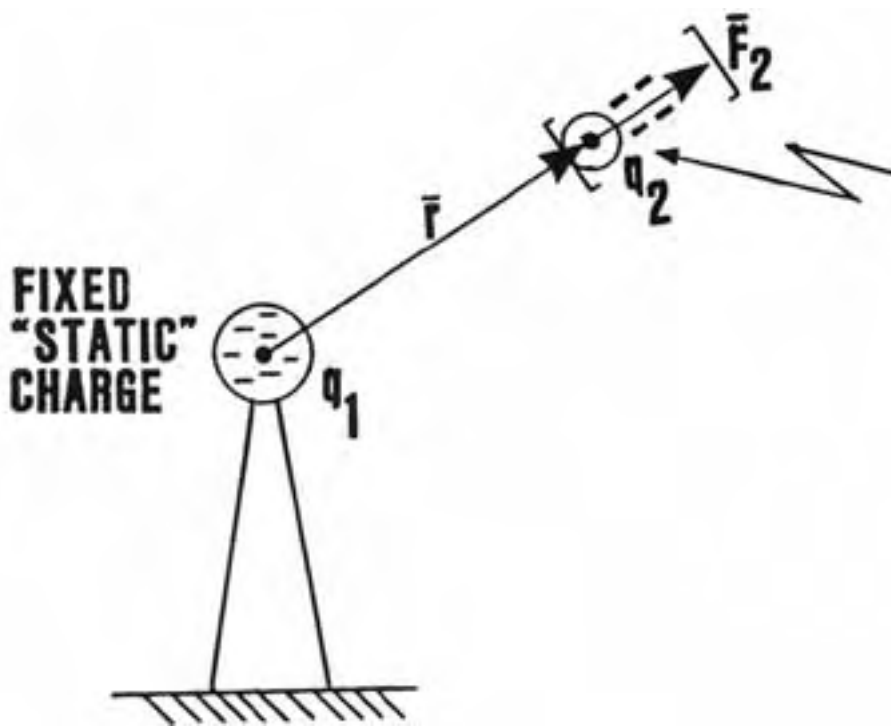

**A NEGATIVELY CHARGED TEST MASS [e.g., AN ELECTRON] BROUGHT INTO THE VICINITY OF  $q_1$  EXPERIENCES A FORCE  $\vec{F}_2$  AS SHOWN. NOTE THE ELECTRON ACTUALLY IS SPINNING. THIS HAS NEVER BEEN DONE WITH A TRUE "STATIC CHARGE", FOR THERE IS NO SUCH THING IN NATURE.**

In my presentation last year, I noted some 22 fundamental flaws in present electromagnetics theory. One of these flaws was in the actual vector theory itself. As we shall discover, one cannot simply plug geometrical vectors into physical systems without making fundamental errors. The vector concept itself must be adapted, for there are now four different kinds of vectors in physics, all confused as the same thing. We will come to that shortly.

To begin, let us look at the fundamental kind of experiment, shown on this slide, from which the idea of electrical force and electric field was taken.

We have a fixed static charged object  $q(1)$  in the laboratory, and we bring in a test charged mass  $q(2)$ . The test charged mass may even be a single electron, as we illustrate here. We show in our example the fixed charge to be negative. When we release the test charge electron, it accelerates away from the fixed charged mass, as shown on the

diagram. Note that we have no force at all until we bring in the test charged mass. Indeed, we shall find that the force is actually **COMPRISED OF** the accelerating test electron. Specifically, it is not something mysterious which appears in vacuum and **PUSHES** on the electron. We shall find that **FORCE IS AN EFFECT, NOT A CAUSE**. It **CONSISTS OF** the "smeared mass" that is accelerating -- in this case, it consists of the smeared, accelerating electron.

We summarize the experiment: in the absence of the charged test particle, no force exists in the vacuum. When we bring in the test charged mass, it accelerates away, and **THE FORCE CONSISTS OF THAT ACCELERATING CHARGED MASS PARTICLE**. The experiment does not at all address or deal with **WHAT EXISTS IN THE VACUUM AROUND CHARGED MASS Q(1) IN THE ABSENCE OF TEST CHARGED MASS Q(2)**. Any assumption of a force existing in the vacuum is sheer speculation and not based on this experiment.

[Next Slide](#)

## [The Tom Bearden Website](#)

SLIDE 6.

### REPETITIONS LEAD TO THE VECTOR "FIELD" CONCEPT

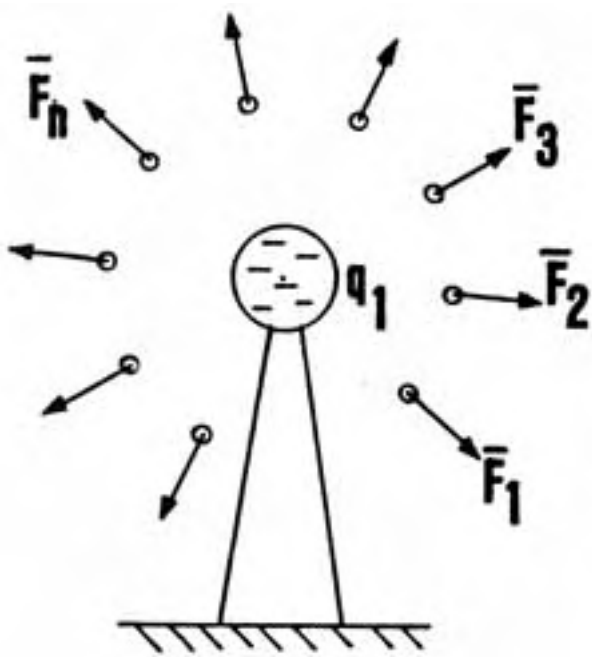

REPEATING FIGURE 4 A NUMBER OF TIMES LEADS TO SETS OF FORCE ARROWS, WHICH WE THEN VISUALIZE IN TOTAL AS A FIELD,  $\vec{E}$ , OF FORCE(S) ABOUT  $q_1$

RIGOROUSLY, THIS "FORCE FIELD" WOULD REQUIRE THAT A SPINNING CHARGED PARTICLE OF MASS EXIST AT EACH AND EVERY POINT IN SPACE ABOUT  $q_1$

On this slide, we show that, as we repeat the experiment by bringing in the test charged mass from differing directions, the same thing happens around the fixed charged mass  $q(1)$ . Test charged mass  $q(2)$  -- our electron -- accelerates radially away from  $q(1)$ .

As we repeat the experiment and draw many of the little arrows radially outward, gradually the idea of a "vector field" emerges. That is, we form the idea that, at every point in space around fixed charge  $q(1)$ , there exists one of our little vector arrows. Thus we assign a vector field to the space: to every point of it, there is assigned both a magnitude and a direction.

However, note that this does not describe the situation as it exists, at any time, in the "present." That is, rigorously any one arrow only exists whenever a little test charged mass is present and accelerating radially away.

We may take the view that the arrow WILL exist WHEN a test

charged mass is brought to that point and released. In that case, the arrow WILL exist in the FUTURE, not the present. And we may refer to that as, it POTENTIALLY exists, when and if.. ..etc.

So already we see a fundamental logical problem in the idea of such a field. It WILL exist in the future, but only POTENTIALLY exists in the present.

Of course I am not the first one to point out such difficulties; the fact that the field concept is erroneous is already well-known to foundations scientists. But it is such a USEFUL concept that it is retained.

Now the  $\ddot{E}$ -field, or electric field, is defined as "the accelerating force on a charged mass per unit charged mass accelerated by it." If there is no charged mass present to be accelerated, then there can be no  $\ddot{E}$ -field present.

So  $\ddot{E}$ -field cannot exist in vacuum, for vacuum presupposes the absence of all observable mass.

So we can rigorously say that no  $\ddot{E}$ -field of force exists around the charged mass  $q(l)$  IN THE PRESENT. At best, it can only POTENTIALLY exist IN THE FUTURE.

[Next Slide](#)



SLIDE 7.

## A SCALAR HAS A HIDDEN [VIRTUAL] VECTOR SUBSTRUCTURE

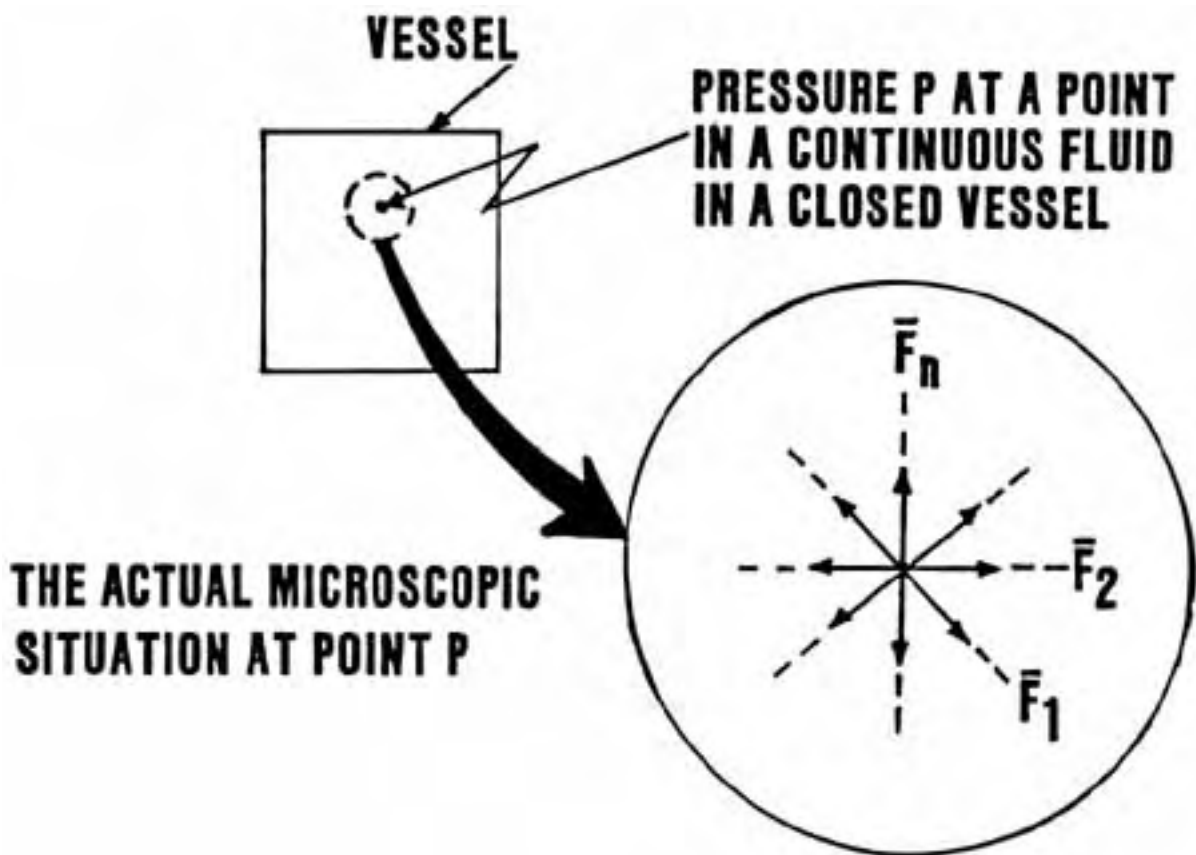

Our next slide shows that a physical scalar quantity has a hidden vector substructure.

For example, we show on the left a closed vessel containing a pressurized gas. The pressure at a point in the gas is a scalar quantity, since it has a magnitude but not a direction. However, physically what we have in the gas is a flux of individual molecules continually through any small volume, which we may let approach a point in the limit. Thus we have a flux in all directions through the point at which we specify pressure.

That is, the scalar "pressure" at a point may be said to contain a substructure of individual molecule flow vectors.

All physical process scalars have such hidden substructures. In

the equilibrium case, the summation of all the individual flux vectors yields a resultant vector zero.

Thus we take the view that ANY PHYSICAL PROCESS SCALAR IS ALSO A ZERO VECTOR, AND ANY ZERO VECTOR IS A SCALAR AND CONTAINS A SUM-ZERO HIDDEN VECTOR SUBSTRUCTURE.

[Next Slide](#)

[The Tom Bearden Website](#)

SLIDE 8.

**SCALAR AND VECTOR SUBSTRUCTURES**

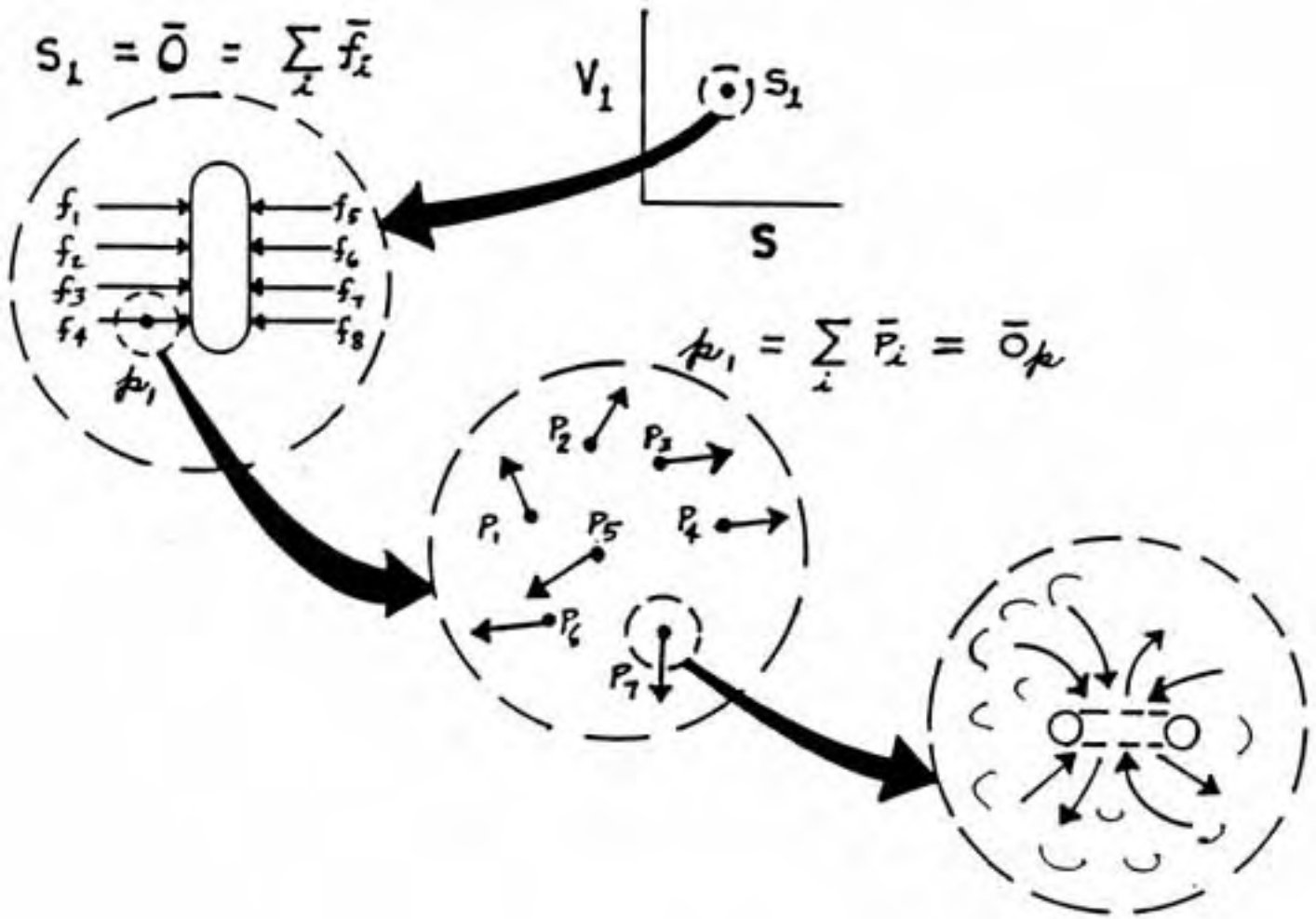

Now let us see if we can do some unusual thinking about the hidden vector substructure of a scalar or zero-vector.

On the leftmost figure in this slide, we show a plate with balanced opposing forces. The vector summation of all the forces' is zero, so the system has no resultant vector. The plate therefore does not move. However, the plate -- that is, the medium in which the forces act -- is stressed, much like the previous example of pressure in a gas. The difference is that now the stress is patterned in its substructure, and not random. Now suppose we rhythmically vary the forces, each the same, in a regular manner in time. Yet we maintain a continuous balance, so there is never a system resultant greater than zero. In this case, we maintain our vector zero, but we are producing regular stress waves in the plate medium..

I think you now can see that I can vary the individual opposing vector pairs so that rhythmic waves flow from top to bottom, or from bottom to top. That, of course, will describe a vector gradient traveling through the medium, and that will be an ordinary "vector wave." Is there any way I can make waves through the medium, and not have such vector waves ever appear?

Indeed there is, if I look further into the substructure. Take one point on one of the vectors shown acting on the plate in the left diagram. That point is a scalar, and it also has a substructure of even finer vectors, as shown in the lower middle figure. And any point in one of these second-order hidden vectors is a scalar and composed of a still finer hidden vector substructure, as shown in the lower right figure. This process repeats ad infinitum, and all is structures within structures. At least it can be modeled that way, for it already is treated that way in particle physics.

Now go back to the second order vector substructure. Here I can establish whatever patterns I wish, and not affect the first order pattern shown in the figure on the left. I can even rhythmically vary things in the second order substructure, and leave a blissfully unchanged first order substructure, to the first order observer.

So I can make as many waves; as I wish through the medium, as long as I stay second order or higher, and the external observer will never see any change at all unless he has a special detector of some sort to detect the lower substructure changes.

As I showed in the Appendix to my book, [The Excalibur Briefing](#), these substructures are in reality the same thing as [hyperspaces](#). And movements in them can proceed much faster than the speed of light.

So I can have higher order signals and waves through the stressed medium without changing the overall first order stress in the medium.

This is a sort of super-relativity; the present relativity is just a special case.

Superluminal communication systems are perfectly possible, but not with the present first order transmitters and receiver/detectors.

Note also that higher order stresses -- stresses in the higher order substructures -- represent special stresses in time, and time has an internal stress-pattern substructure. The higher order stress waves are phase waves or phase fluctuations in that respect.

Also note that Charles Musés has already created the hypernumber mathematics of the structure of time, and it is largely in his mathematics that these concepts will have to be mathematically modeled.

[Next Slide](#)

SLIDE 9.

## SUPERPOSITION DOES NOT ELIMINATE THE VIRTUAL SUBSTRUCTURE

---

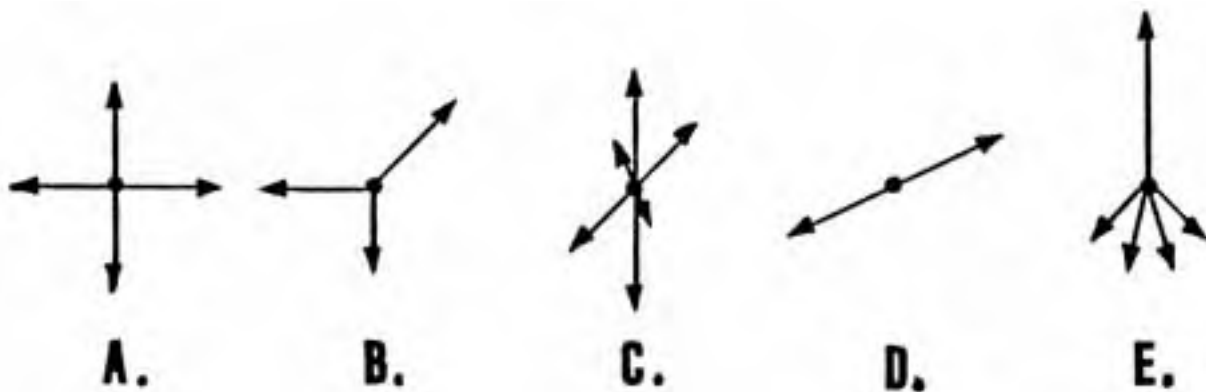

**TWO OR MORE MACROSCOPICALLY "EQUAL" VECTORS OR SCALARS CAN DIFFER DRASTICALLY IN THEIR VIRTUAL SUBSTRUCTURE DISTRIBUTIONS. EVEN TWO "ZEROS" MAY BE DYNAMICALLY DIFFERENT DUE TO THEIR DIFFERING SUBSTRUCTURES.**

---

Next we show some simple substructures of a zero vector. All of these vector systems sum to zero vectorially. Note that if we superpose two of these structures, all substructure vectors are still present., and the vector summation is still zero.

Also notice that, from the standpoint of substructuring, zeros can be and are drastically different.

We can even make rhythmic waves in the substructure by superposing patterned zero vectors in a regular fashion.

[Next Slide](#)

## PHYSICAL VECTORS

---

- **VECTOR: A "SMEARED PARTICLE"**
  
- **FOUR MAJOR PARTICLES IN PHYSICS:**
  - **POINT [MASSLESS, CHARGELESS]**
  - **MASS [CHARGELESS]**
  - **CHARGED MASS**
  - **CHARGED POINT [MASSLESS]**
  
- **LEADS TO FOUR MAJOR VECTORS:**
  - **GEOMETER'S**
  - **MECHANIC'S**
  - **ELECTRICIAN'S**
  - **ADVANCED ELECTRICIAN'S**

In quantum mechanics, as we approach the quantum level, we find that the notions of a particle (static concept) and a wave become inseparable. That is, any particle becomes a "smear" in length and time, and it becomes inseparable from its smear. At the quantum level, there is no separate energy, length, mass, momentum, energy, or time -- all are welded together inextricably into a quantity called "action," having the units of angular momentum.

So at the fundamental quantum level, a moving point becomes a smear, and a vector represents a physical, undifferentiated entity.

To go quickly, we now define a vector as consisting of a smeared particle. That is, the particle is smeared in both time and length, and it is not differentiated from time or length.

There are four kinds of particles in physics which can be smeared to form vectors. First, there is a point in space or spacetime. This point may be approximated as massless and chargeless. At least that is the way the geometers of old conceived it in the abstract, and so the idea of a "point" in space assumes it to be chargeless and massless. Second, there is a tiny particle of mass, often abstracted to be a "point-mass," but visualized as having no charge. This is the mechanic's particle. Third, there is a tiny charged mass, such as an electron, and this is the electrician's particle. Again, it is often abstracted as a charged point-mass. Fourth, there is a charged point, having no mass, and this is the advanced electrician's particle, which he uses to form the idea of potentials and fields.

Smearing these four particles at the fundamental quantum level produces four different kinds of physical vectors: the geometer's, the mechanic's, the electrician's and the advanced electrician's vectors. They are all different.

[Next Slide](#)



[The Tom Bearden Website](#)

SLIDE 11.

## THE FOUR VECTORS OF PHYSICS

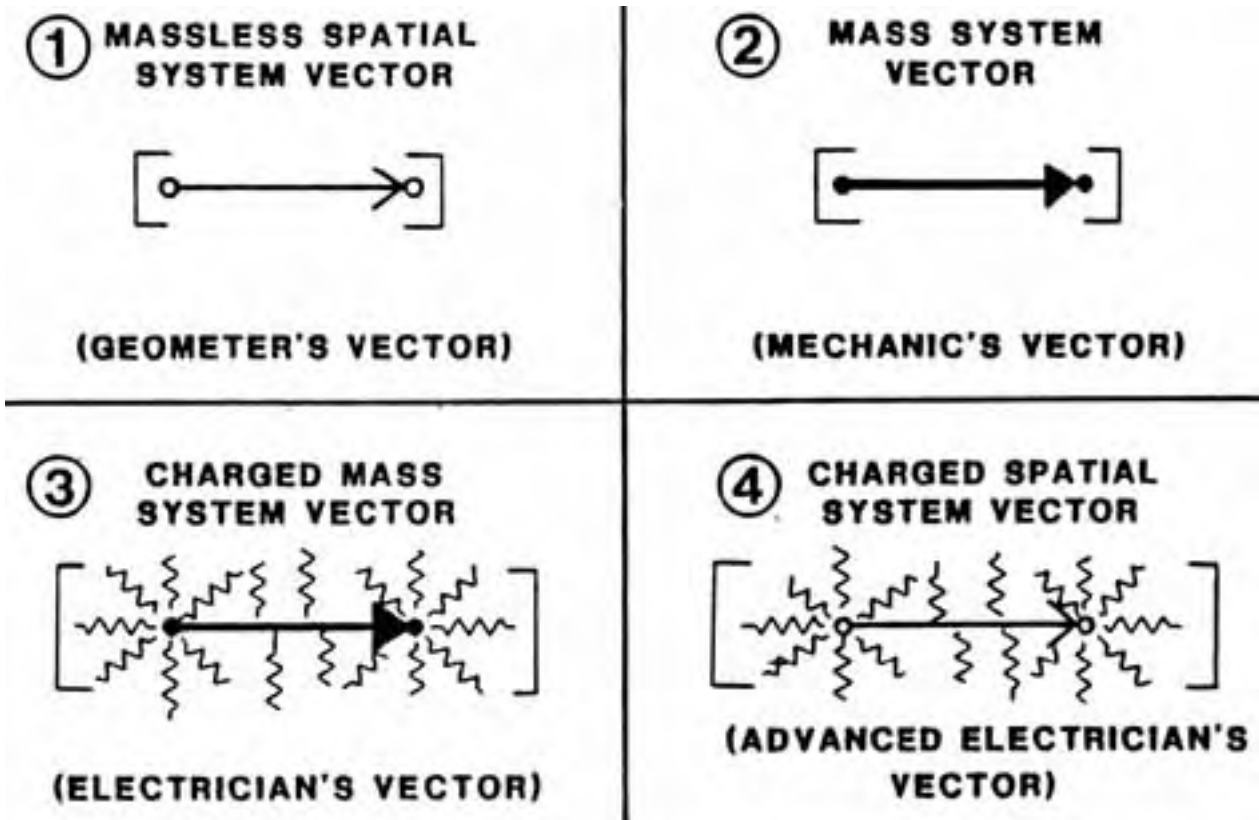

On this slide we show a graphic illustration of each of these vectors.

Note that they may be visualized as smeared particles, but the particle is not separate from the smear in time and length.

Each vector must be considered as a unitary entity -- it is a special kind of quantum, if you will.

Each is a special quantum of motion.

And Dewey Larson has it right when he says, "All is motion."

[Next Slide](#)

## FORCE DEFINITION

---

- *A TRUE DEFINITION IS AN IDENTITY.*

$$F \equiv d/dt (mv)$$

- **FORCE CONSISTS OF THE TIME RATE OF CHANGE OF MOMENTUM**
- **MOMENTUM IS A MASS SMEARED THROUGH A LENGTH IN A CERTAIN TIME**
- **FORCE CONSISTS OF MASS-MOTION-CHANGE**
- *FORCE IS AN EFFECT, NOT A CAUSE !*

We now look a little closer at the concept of a force.

I point out that a true definition is an identity. If a supposed definition of an entity is not an identity for that entity, then it is not a definition at all, but only a statement ABOUT the entity.

It may come as somewhat of a shock to the normal engineer and scientist that the foundations concepts of physics -- such as force, mass, energy, etc. -- are ALL in serious difficulty and contain many unresolved logical conflicts.

Force is in that kind of difficulty, and it has that kind of logical conflict.

In fact, in its force equations, physics has not even applied its own present definition of force.

As we show here, force is generally defined as the time rate of change of momentum.

If that is true, then as an identity the definition states that a force CONSISTS OF the time rate of change of momentum.

And of course, momentum is mass times velocity. Hence momentum is a mass smeared through a length and through a certain time.

Force then consists of the time rate of change of that smearing. That is, we smear the mass through time and length, faster or slower.

But if force CONSISTS OF that smearing change, it does not CAUSE it.

Force is thus an effect or result, not a cause.

This implies that there is a more fundamental mechanism that causes or generates force itself -- ANY force. If we can find that hidden mechanism, we may well find the long-sought unified field theory, since it will unify all forces on a common mechanism.

[Next Slide](#)

[The Tom Bearden Website](#)

SLIDE 13.

## FORCE IS AN EFFECT NOT A CAUSE

---

1.  $\bar{P} = M\bar{V}$  (MACROSCOPIC)
2.  $\bar{P} \equiv \overline{[M\bar{V}]}$  (MICROSCOPIC)
3.  $\bar{F} = \frac{d\bar{P}}{dt}$  (MACROSCOPIC)
4.  $\bar{F} \equiv \frac{d\bar{P}}{dt} \equiv \frac{d}{dt} \overline{[M\bar{V}]}$  (MICRO)  
 $\equiv \overline{[M\bar{V} + M\bar{a}]}$
5.  $F \equiv \overline{[M\bar{a}]}$  (NONRELATIVISTIC)
6. FORCE CONSISTS OF A "SMEARED MASS"
7. IT IS MASS-ACCELERATION, IT DOES NOT CAUSE IT.
8. FORCE IS AN EFFECT, NOT A CAUSE!

On this slide, we show briefly how one might express this idea in mathematical symbology.

Macroscopically, momentum consists of mass times velocity. Microscopically, the mass and the velocity are inextricable, and it is not proper to speak of a "mass in motion," but only of "mass-motion." We show this in equation 2.

We take the macro definition of momentum, as shown in equation 3, and express it for the microscopic, unseparated case, as shown in equation 4.

In the nonrelativistic case, we may consider  $\dot{m}$  to be zero, since the time rate of change of mass is almost zero. In that case, force may be defined for the microscopic case as a smeared accelerating mass, as shown in equation 5.

Force thus consists of the welded mass and acceleration, with no seam in the middle.

It IS mass-acceleration; it does not CAUSE it. Therefore force is an effect, not a cause.

[Next Slide](#)

## FORCE AND $\bar{E}$ -FIELD DO NOT EXIST IN VACUUM

---

1. 
$$\bar{F}_p \equiv [\overline{M_p \circ \bar{a}_p}]$$

2. WITHOUT M, THERE IS NO  $M_p$ , NOR  $\bar{F}_p$

3. HENCE FORCE DOES NOT EXIST IN VACUUM.

4. 
$$\bar{E}_{cm} \equiv \frac{\bar{F}_{cm}}{q_{cm}}$$

5. WITHOUT M, THERE IS NO  $\bar{F}_{cm}$ , NOR  $q_{cm}$ .

6. HENCE  $\bar{E}$ -FIELD DOES NOT EXIST IN VACUUM.

7. SIMILARLY,  $\bar{B}$  AND  $\bar{G}$  DO NOT EXIST IN VACUUM.

8. NO FORCE FIELD EXISTS IN VACUUM.

But if force CONSISTS OF mass welded to acceleration, it cannot exist in the absence of mass.

Hence force does not exist in vacuum.

Further, the  $\ddot{E}$ -field (Electric field) of a charged particle is defined as the force on a charged mass, divided by the mass. That is, the  $\ddot{E}$ -field is thought to represent the force per unit charged mass. And then it is assumed to exist in vacuum.

But vacuum is without mass or charged mass, observably. Without mass, neither force nor charged mass exists.

Therefore the  $\ddot{E}$ -field does not exist in the vacuum.

Magnetic field (B) and gravitational field (G) are similarly defined, and they have the same logical difficulties.

Therefore neither magnetic field nor gravitational field exist in vacuum.

A priori, NO force field exists in vacuum.

The greatest error in physics has been the assignment of a force as a cause, and thus assigning it to the vacuum. The force is an effect, and it never exists in vacuum, a priori.

[Next Slide](#)

## COROLLARIES

---

- **MORE PRIMARY MECHANISM  
CAUSES/GENERATES  
FORCE -- ANY FORCE**
- **FORCE DOES NOT EXIST IN VACUUM,  
SINCE  
VACUUM IS THE ABSENCE OF MASS**
- **FORCE FIELDS DO NOT EXIST IN  
VACUUM**
  - **E-FIELD**
  - **B-FIELD**
- **TRANSVERSE [HERTZIAN] WAVES  
DO NOT EXIST IN VACUUM**



Without belaboring the issue, I now point out and summarize some of these conclusions.

First, a more primary mechanism causes or generates force -- ANY force.

Second, force implies the presence of mass a priori. Force does not exist in vacuum, since vacuum is the absence of mass.

Third, no force fields of any kind exist in vacuum, including  $\vec{E}$ -field, B-field, and gravitational field.

Fourth, since Hertzian waves are defined in terms of  $\vec{E}$  and H force fields, and these fields do not exist in vacuum, then Hertzian waves do not exist in vacuum.

Tesla pointed out long ago that vacuum EM waves are longitudinal waves, not Hertz waves. Vacuum EM waves are similar to sound waves in a gas.

The Hertz wave exists as a matter wave in the electron gas in a transmitting antenna, and in the electron gas in a receiving antenna, but does not exist in the vacuum in between the two antennas. Between them, EM waves are longitudinal waves.

[Next Slide](#)

## ENERGY IS DERIVED, NOT FUNDAMENTAL

---

- **ENERGY IS CONGRUENT TO WORK**

$$dW = \vec{F} \cdot d\vec{s}$$

- **BUT FORCE IS AN EFFECT, NOT A CAUSE**
- **THUS WORK IS AN EFFECT, NOT A CAUSE**
- **ENERGY  $\equiv$  WORK CAPACITY**
- **A MORE FUNDAMENTAL MECHANISM GENERATES "ENERGY"**

$$\Delta E = \frac{\Delta A}{\Delta T}$$

- **ENERGY IS AN EFFECT, NOT A CAUSE**

Energy is usually taken as "the capacity to do work" at some future time. In other words, when we refer to the energy of something, we refer to HOW MUCH WORK IT CAN DO IN THE FUTURE, IF AND WHEN WE ARRANGE FOR IT TO DO IT. Rigorously, a body has no "work" at a particular instant in time, so we use "energy" to refer to potential work that can, or will, be done in the future. Thus energy is always congruent to work in the future.

And for that reason, the units of energy are the units of work; the only difference is in the time the work is done, relative to the "now" or "present" we are speaking of.

Energy is the potential for work to be done in the future.

But what is work?

Well, work is defined in terms of the movement of a force through a distance. And it is understood that only the projection

of the force along the line of movement is "working." Thus work is defined differentially as shown on the slide. The differential of work is equal to the dot product of the moving force times the differential of displacement.

But as we have seen, force is an effect, not a cause.

That is, when we calculate the work done, it's always in the past, never in the present or future. It's always been DONE, and has been expended.

Being in the past, it's gone forever, so it certainly isn't the CAUSE of anything which happens in the future.

Thus work is an effect, not a cause.

That's interesting, because then it certainly does not directly generate "energy," since energy is something in the present which speaks of future work to be done.

Rigorously, the fundamental quantum -- which is what exists in the present, in unseparated and unquantized form -- consists of action. NOT energy, NOT time, NOT length, NOT momentum exclusively, but all of these INclusively.

And a change in energy occurs when a quantum is separated at a certain rate in time. Thus delta energy equals the time rate of change of action, or delta action divided by the delta time used in separating the quantum and fissioning it into parts (collapsing the wave function).

Thus energy itself is an effect or result of a more fundamental mechanism, and it is not a cause.

In quantum mechanics all this has been neatly "buried" in the mysterious "collapse of the wave function," which is supposedly what "causes" everything to happen. And then we swear that what results after the collapse is a totally statistical selection from the possible states of the system we are examining. We thus say that the microworld is totally statistical at base. Of course we also build a wave equation or wave function which propagates forward in time with rigorous causality, and that wave or function absolutely controls the basket of "possible states" allowed .

All that says is that the "wave function times time" is what exists in the present, when observation has not been made by "stopping time." And then we "stop time" in a rather blunt manner, somewhat like firing a billiard ball blindly into a group of billiard balls on a table, and we live with what gets hit and pops out.

If we examine this "time" that is flowing, look into its substructure, and arrange that substructure as we will, we can control which "billiard ball" is hit and which pocket it goes into. By working on the vector substructures of time, we can thus deliberately control the microworld and make it causal, not

statistical. Quantum mechanics is in error in stopping where it has; it is presently only a first order approximation of the real quantum mechanics that awaits.

Einstein was correct after all; God does NOT play dice with the universe when one considers all levels.

One finds oneself in a statistical situation at one level only when the constituent sublevels of it are uncontrolled.

[Next Chapter](#)

SLIDE 17.

## **EXISTENCE IN, AND PASSAGE THROUGH, TIME**

---

- **IN RELATIVITY, TRANSLATION OF A BODY AND  
PASSAGE THROUGH  
TIME ARE RELATED**

$$\Delta L = C \Delta T$$

- **"MASS" IS SPATIAL**
  - **DOES NOT EXIST IN TIME**
  - **"MASS-TIME" EXISTS IN TIME**
- **VIRTUAL FLUX TO AND FROM A BARE  
PARTICLE DETERMINES ITS  
"PASSAGE THRU TIME"**
- **SPHERICAL SPIN OF A MASS PARTICLE [L<sup>3</sup>]  
COUPLES IT TO THE  
SPACETIME VACUUM [L<sup>3</sup>T] VIRTUAL PARTICLE  
FLUX**
- **PASSAGE THROUGH ORDINARY TIME IS  
CONTROLLED BY  
CREATION AND ANNIHILATION OF QUANTA**

On this slide, we simply point out that translation of a body through space and its passage through time are related, according to relativity.

Now "mass" is spatial.

It does not exist in time.

Only things which contain the unit of time can "exist in time."

Otherwise, the thing only exists as such when the passage of time has been momentarily stopped -- usually by photon emission and the consequent carrying off of the time unit by the photon.

Since every mass that has temperature -- and every mass does -- is continually absorbing and emitting photons, then the mass is continually grabbing a time tail (absorption) and losing it (emission) shortly thereafter.

Masstime is what exists in time, not mass.

And every mass particle is continually turning from mass to masstime to mass, etc.

Indeed, it is the summation of the absorption and emission of virtual subquanta by a mass particle -- i.e., its "charge" -- that determines its rate of flow through "time."

And the spherical spin of a mass particle couples the particle of mass to the spacetime vacuum; that is, to the virtual particle flux.

Passage through ordinary time is controlled by creation and annihilation of quanta, and these processes are controlled by substructure (subquantal) actions and interactions.

[Next Slide](#)

SLIDE 18.

## SOME IMPLICATIONS

---

- **MODIFIES CONSERVATION OF CHARGE**
- **MODIFIES CONSERVATION OF ENERGY**
  - *MASS*
  - *ENERGY*
  - *AN ENERGY (MASSLESS CHARGE)*
- **MODIFIES NEWTON'S LAW**
  - *FOR EVERY ACTION, THERE IS AN OPPOSITE AND EQUAL REACTION*
  - *REACTION NEED NOT BE LOCAL*
  - *REACTION NEED NOT BE ANTIPARALLEL*
- **UNIFIED FIELD THEORY**

Without belaboring the issue, I now simply point out some implications of the new approach.

First, we modify two laws -- the conservation of charge and the conservation of energy -- by combining them into one law, a new conservation law in which anenergy is conserved.

Neither charge per se nor energy per se need be conserved; but the overall anenergy (massless charge) equivalency is what is conserved. This allows us to derive mechanisms for free energy from the vacuum, for example. These mechanisms readily violate the present conservation of energy law, but do not violate the overall conservation of anenergy law.

It is the total anenergy equivalency of mass, energy, and massless charge that is now to be conserved in general. The old laws are now just special cases.

Also, Newton's third law -- for every action there is an equal and opposite reaction -- is modified. It still applies, but in changed form.

The reaction still occurs, but it need not be local, and it need not be antiparallel to the original action.

Thus it is now possible to design and build a "locally reactionless" inertial space drive for a vehicle.

The final implication is that the common mechanism producing force -- any force -- provides a unified field theory. Specifically, it provides one which easily lends itself to direct engineering. It is not esoteric nor mysterious. It is practical and physical, and it can be done with some modifications to our present electrical circuits and devices.

[Next Slide](#)



## CONSERVATION OF AN ENERGY (AE): (AN EXPANDED ENERGY CONSERVATION LAW)

### 1. CONSERVATION OF CHARGE:

- "CHARGE" = MASS ( $M_C$ ) + CHARGE ( $AE_C$ )
- $|M_C| + |AE_C| = K_1$

### 2. CONSERVATION OF ENERGY:

- DYNAMIC ENERGY ( $E$ )
- ENERGY EQUIVALENCE OF MASS ( $M_E$ )
- $|E| + |M_E| = K_2$

### 3. ADDING (1) AND (2):

$$|M_C| + |AE_C| + |E| + |M_E| = K_1 + K_2 = K_3$$

### 4. LETTING $|M| = |M_C| + |M_E|$ ,

$$|M| + |E| + |AE_C| = K_3$$

### 5. LETTING $|M| = AE_1$ , $|E| = |AE_2|$ , $|AE_C| = AE_3$ ,

$$AE_1 + AE_2 + AE_3 = K_3$$

We briefly show a simplified derivation of the new conservation of anenergy law.

We express the conservation of charge law by correcting the term "charge" to show its true meaning: charged mass. We use the absolute value symbol to mean the "anenergy equivalency."

As shown on the slide, we account separately :for the mass ( $m$ -sub- $c$ ) of the conserved charges and the virtual particle charge flux (the anenergy --  $AE$ -sub- $c$ ) of the charges conserved. That law now says that the absolute values of the masses and the massless charge fluxes have a total constant summation.

For a dynamic mass, we do a similar thing, in this simplified case ignoring potential energy of position, and taking the energy equivalence of the dynamic energy ( $M$ -sub- $E$ ) and the rest mass energy of the particles,  $M$ -sub- $E$ . The conservation of energy now states that these two terms have a constant absolute value summation.

We add equations 1 and 2, getting equation 3. We consolidate like terms to get equation 4.

Expressing all terms in their anenergy equivalencies (absolute values), we get equation 5, which is the overall conservation of anenergy equivalency.

Note that we now can change mass into energy or anenergy (massless charge), energy into mass or anenergy, and anenergy into mass or energy.

Thus we can turn everything into pure vacuum ether (pure massless charge, pure anenergy, pure electrostatic scalar potential, pure stress on spacetime) or we can turn part of the vacuum into energy or particles of mass.

Vacuum now becomes a very real thing indeed.

It is pure anenergy.

Pure massless charge, pure electrostatic scalar potential, pure "broken bits" (subquantal bits) of (quantized) energy.

The vacuum is identically the virtual state.

It is not an emptiness filled with virtual things; rather, it IS the sum total of those virtual things, for they are totally unseparated until some sort of "conceptual observation" is invoked.

Physics should have adopted Einstein's suggestion that the vacuum, complete with its EM and gravitational fields, be called the ether.

[Next Slide](#)

# The Tom Bearden Website

SLIDE 20.

## **FREE ENERGY IS ALLOWED**

---

- **ANY ONE-WAY GATING PROCESS FROM AN ENERGY TO ENERGY YIELDS "FREE ENERGY" SINCE THE AN ENERGY IS AUTOMATICALLY REPLENISHED BY THE UNIVERSE.**

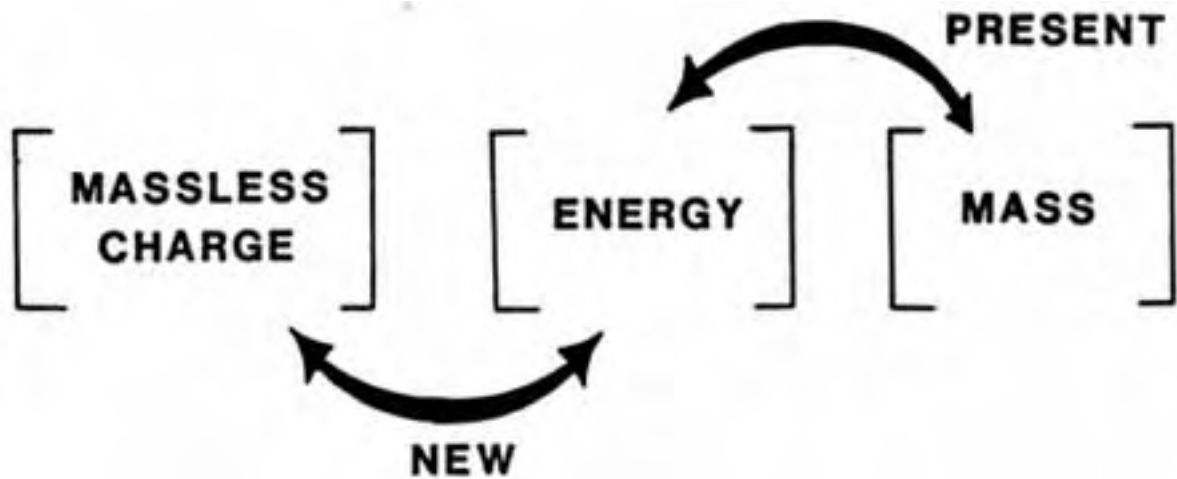

Now we can put the search for free energy devices on a rigorous scientific basis.

As shown here, mass and energy are translatable one into the other. So are massless charge and energy.

And the universe is filled with fantastic amounts of anenergy; ultimately, that is what the universal vacuum IS.

Any one-way gating process from anenergy to energy yields "free energy" since the anenergy is automatically replenished by the universe.

A sort of Maxwell's demon, after all, is what we need. Only we need one which works with the virtual state, not observable molecules.

Fortunately nature has provided several Maxwell's demons of this sort, if we but recognize them and learn to use them.

[Next Slide](#)

SLIDE 21.

## **SCALAR POTENTIAL CAN FORCE THE RELATIVISTIC CASE**

---

- **FOR SCALAR POTENTIAL  
ENERGY  
OF APPRECIABLE SIZE  
RELATIVE TO  
A PARTICLE'S REST  
ENERGY.**
  - **NEWTONIAN  
MECHANICS AND**
  - **THE SCHRODINGER  
EQUATION**
  
- **MAY BE INADEQUATE**
  - **EVEN IF  $v/c$  IS SMALL**

Bloch & Crater, "Lorentz-invariant potentials and the non-relativistic limit," American Journal of Physics, Vol. 49, No. 1, Jan. 1981, pp. 67-75

First, let us now digress to point out that one does not have to have relativistic velocity to obtain relativistic effects.

One can use the common electrostatic scalar potential to drive the situation relativistic. On this slide we show just one of several references in the standard literature that address this fact.

Let's understand what we are saying.

Anything you get from a relativistic situation, you can get directly by cleverly applying electrostatic scalar potential.

You can get a change in the passage through time, you can get energy changes, mass changes, inertial resistance changes, etc.

You can bend, warp, and twist spacetime like a pretzel.

If you "wave" the scalar potential by simply varying it, you can create pure time waves. You can also produce pure inertial field waves, pure gravitational waves, etc.

The ability to engineer the curving of spacetime allows the direct ability to engineer physical reality itself.

[Next Slide](#)

# [The Tom Bearden Website](#)

SLIDE 22.

## SCALAR STRESS WAVE [O-WAVE] [TESLA WAVE]

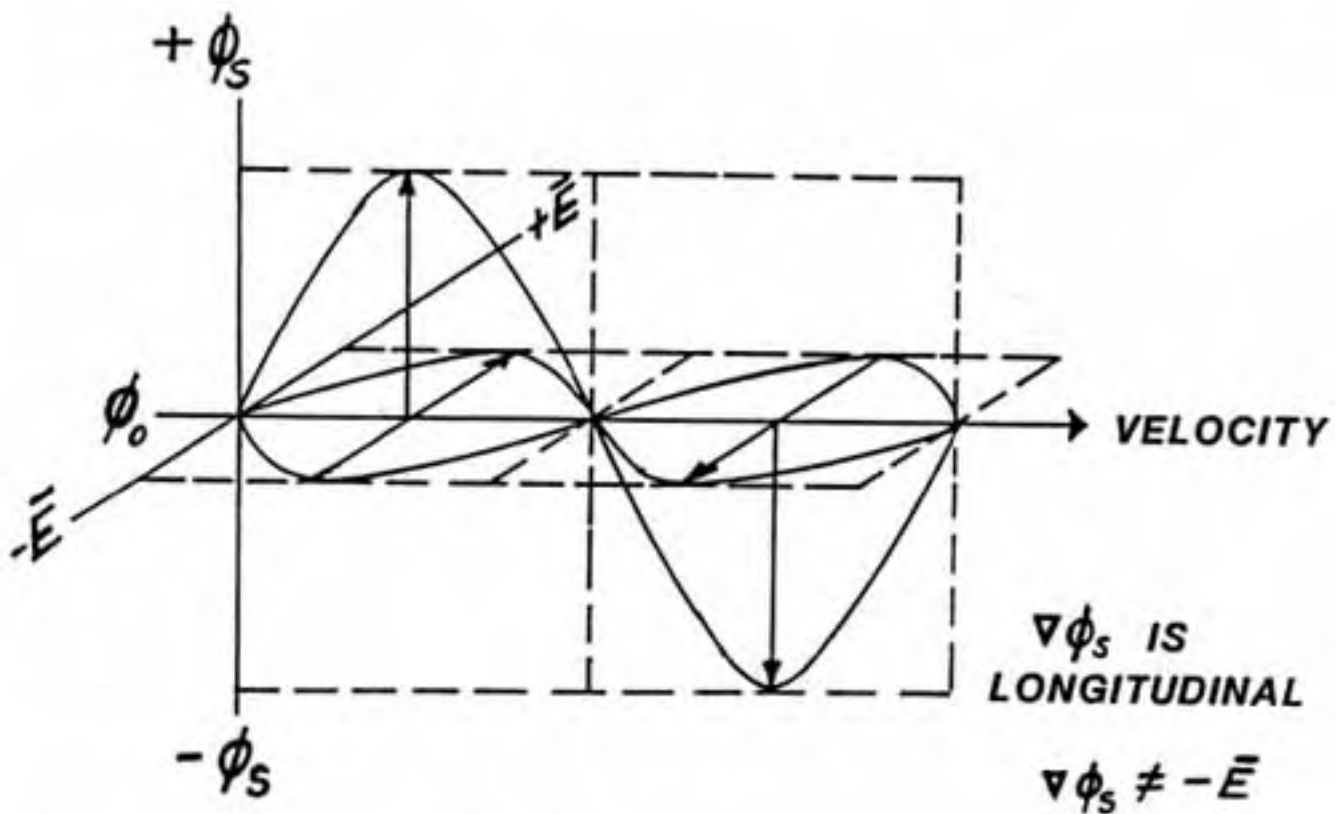

On this slide we now show a simple way to make a scalar, zero-vector wave -- the kind of wave originally discovered by Nikola Tesla.

It's simple. We just believe that a sum-zero vector substructure makes a scalar quantity, and we MAKE some scalars that way.

We also understand that a zero-gradient of a scalar is a zero vector, so that the scalar itself may be taken to be a zero vector.

The simplest explanation of this wave is as follows:

First, in physics we have two competing, mutually exclusive theories as to the nature of

electromagnetic energy: the wave theory and the particle theory. Physicists argued for decades over these theories, for some experiments support one and some support the other. They never solved the problem; they just agreed to quit arguing. They formulated the "duality" principle to allow the saving of face to both sides.

Briefly, the duality principle implies that, whatever the nature of electromagnetic energy is before an interaction, in the interaction you can get it to act as a wave or as a particle. In other words, AS IT EXISTS, BEFORE THE INTERACTION, it is implicitly both particle and wave, joined together in some fashion, without being explicitly either one.

With the fourth law of logic, this becomes perfectly clear. With three-law Aristotlean logic, the problem is unresolvable.

Let us use this idea of "explicit duality without implicit duality" to analyze the wave shown on the slide.

First, from a wave aspect, the E-fields and the B-fields of the two waves do superpose and vectorially add. Since the waves are 180 degrees out of phase, the exterior resultant wave has a zero electric field and a zero magnetic field. Therefore it is a "zero-vector" wave, or "scalar" wave. It's a wave of pure stress in spacetime.

However, this scalar wave has a precisely determined substructure, consisting of two ordinary sine waves, each of which comprises an ordinary E-H vector EM wave.

Now we apply the photon consideration (remember, before we interact with the wave, it must implicitly possess BOTH wave and particle natures combined, and we have so far only examined the implication of the wave nature.

The theory of photons' states that they are monocular critters. Photons pass right through other photons without interaction, in a linear situation. Therefore they can coexist without interaction, which is what we show here.

One photon, by the way, is one wavelength .

The photon theory requires that both substructure waves continue to exist as independent photons.

Therefore we are assured that our substructure is intact.

However, notice that the totality of the two



waves stresses spacetime. In other words, we have twice the stress on spacetime now as we would have from either wave separately.

This wave is therefore just a pure stress wave in spacetime itself.

This thing oscillates time, oscillates the relativity of the situation, and can affect energy, time flow rate, inertia, gravity, etc. aspects of an absorbing system.

Note that we have a rhythmic oscillation in phi ( $\emptyset$ ), and we have a longitudinal stress wave, very similar to a sound wave. The MEDIUM for this wave is the virtual particle flux that identically comprises vacuum spacetime itself.

[Next Slide](#)

[The Tom Bearden Website](#)

SLIDE 23.

## SCALAR $\ddot{O}$ -WAVE PRODUCTION

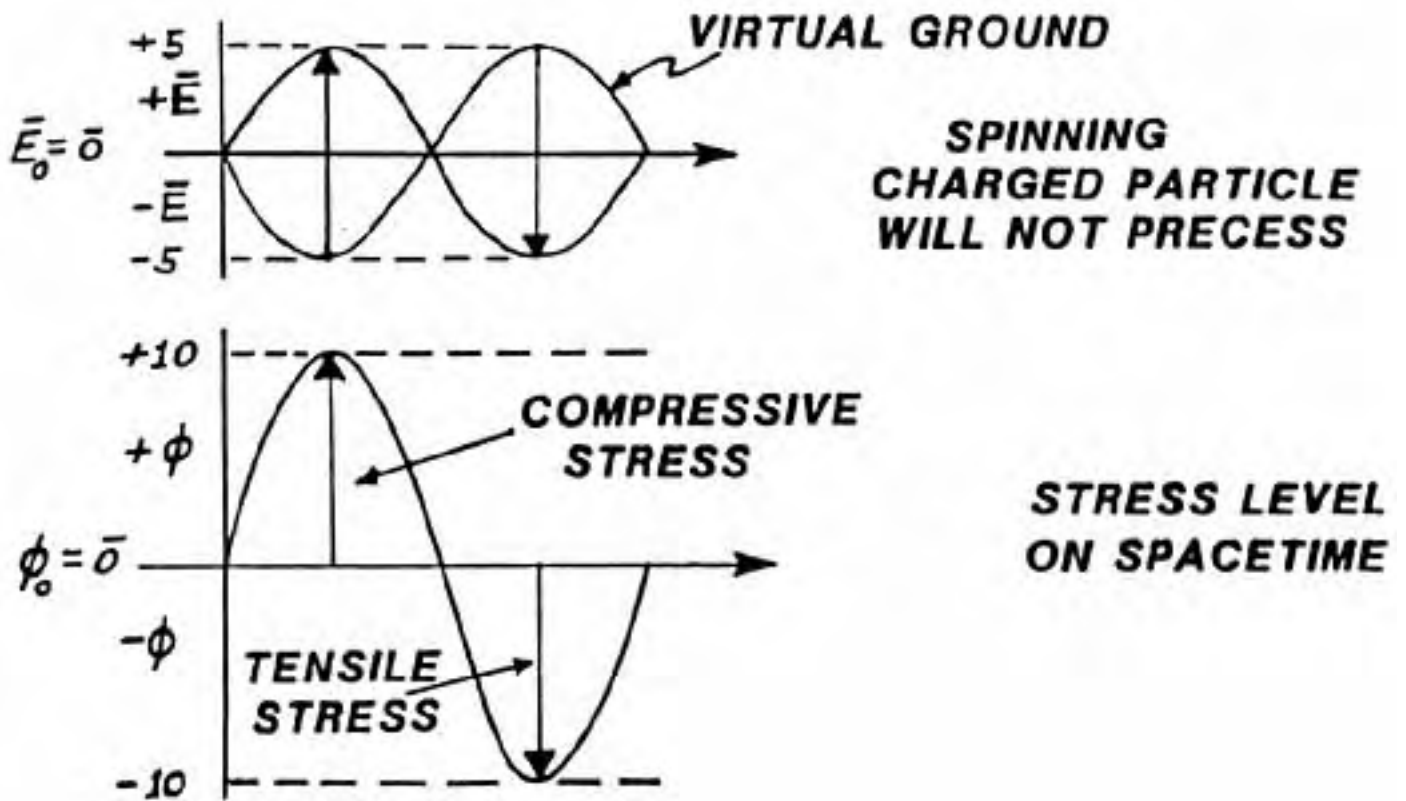

On this slide we show how to regard the magnitude of the stress, by using one wave envelope as "virtual ground." In the top diagram, the original E-field stress of each wave has a magnitude of 5, and the composite stress wave now has a magnitude of 10, in whatever units we choose to express them.

We show in the bottom diagram that during one half cycle we have compressive stress in the virtual particle vacuum flux, and during the second half cycle we have tensile stress.

This shows the wave is like a sound wave in the gaseous molecules of the air.

However, this wave has one difference. It also

oscillates time, and thus has at least one additional degree of freedom, compared to ordinary EM waves.

In fact, this wave can be made n-dimensional and hyperspatial.

As a first order approximation, we can treat such a wave in

a spatial fashion, if the wave is not too great in magnitude and the relativistic oscillation of time and inertia is not too large.

[Next Slide](#)

## A SIMPLIFIED CHARGED PARTICLE

---

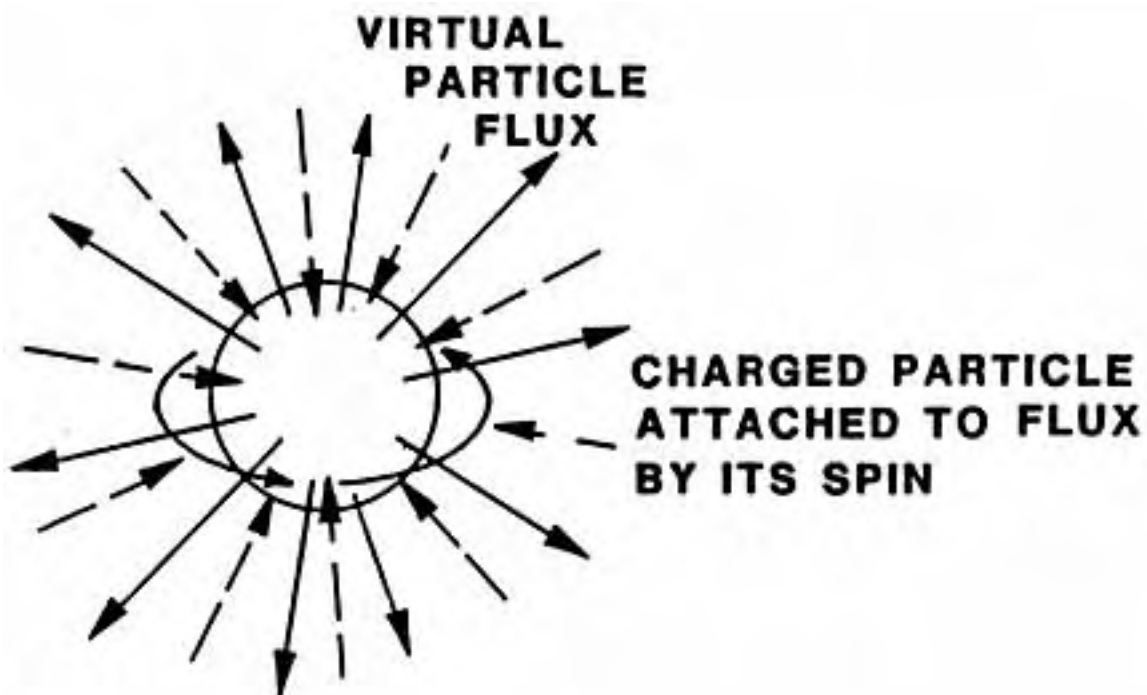

**(THINK OF THE FLUX IN AND OUT, EXCEPT GRADIENTS ARE SPIRAL-LIKE, DUE TO PARTICLE'S SPIN)**

We now digress slightly to pick up some more concepts.

On this slide, we show a simplified physical model of a charged particle. According to present particle physics, we model it as an observable, spinning bare mass in the middle, connected to a spray of virtual particles on and off the mass in all directions.

It is the spin of the mass that "attaches" the spray of virtual particles to and from itself.

Note that, because of the spin, the gradient lines of flux will actually be spiral or vortex in nature.

Also note that, when EM theory was founded, no one knew that an electron was spinning. Electron spin was therefore omitted from the foundations of present

electromagnetic theory, and compensated for later by strictly ad hoc measures.

[Next Slide](#)

SLIDE 25.

## A CHARGED PARTICLE IS A SPECIAL KIND OF "SPRAY NOZZLE"

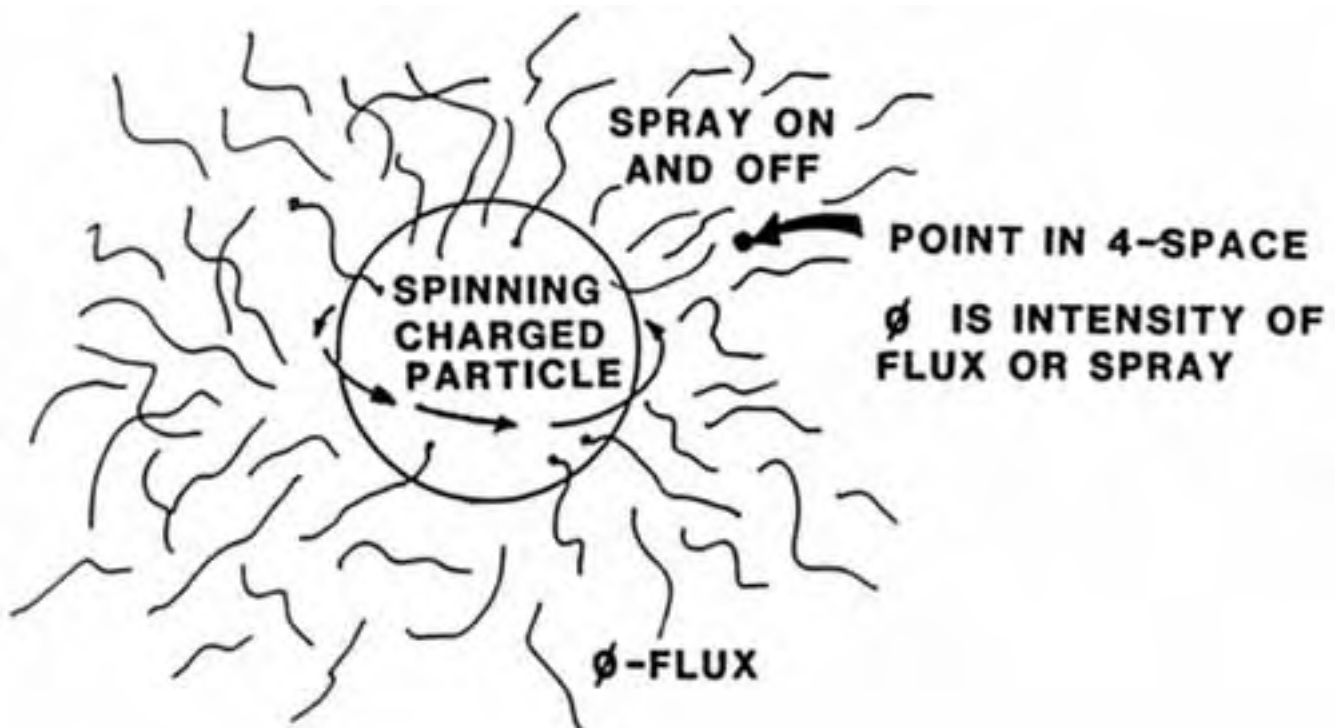

**(SPRAY IS THROUGH 4 DIMENSIONS, NOT JUST 3)**

Here we show a very important concept, and a very important fact of nature.

A charged particle may be idealized as a special kind of spray nozzle.

The 3-dimensional particle of mass is spraying out virtual particle fluid, and sucking in virtual particle fluid, in four or more dimensions.

We never have to furnish or replenish the spray. Nature provides that. And it's inexhaustible. It comes from the entire virtual particle flux vacuum of the universe. It's already connected firmly to matter, by its connection to the spinning charged particle of mass.

I repeat and strongly stress: This tremendous, continuous spray of virtual particles is absolutely free,

and absolutely furnished by the universe.

We don't have to create the basic pumps for the fluid. We just move the spray nozzles around, by moving the spinning charged masses around.

We never furnish any ultimate energy to or in our present EM circuits. We just pump around the spray nozzles, gating the spray furnished by the universe.

[Next Slide](#)

[The Tom Bearden Website](#)

SLIDE 26.

## AN OBSERVABLE CHARGED PARTICLE IS DIRECTLY CONNECTED TO VIRTUAL PARTICLE FLUX VACUUM

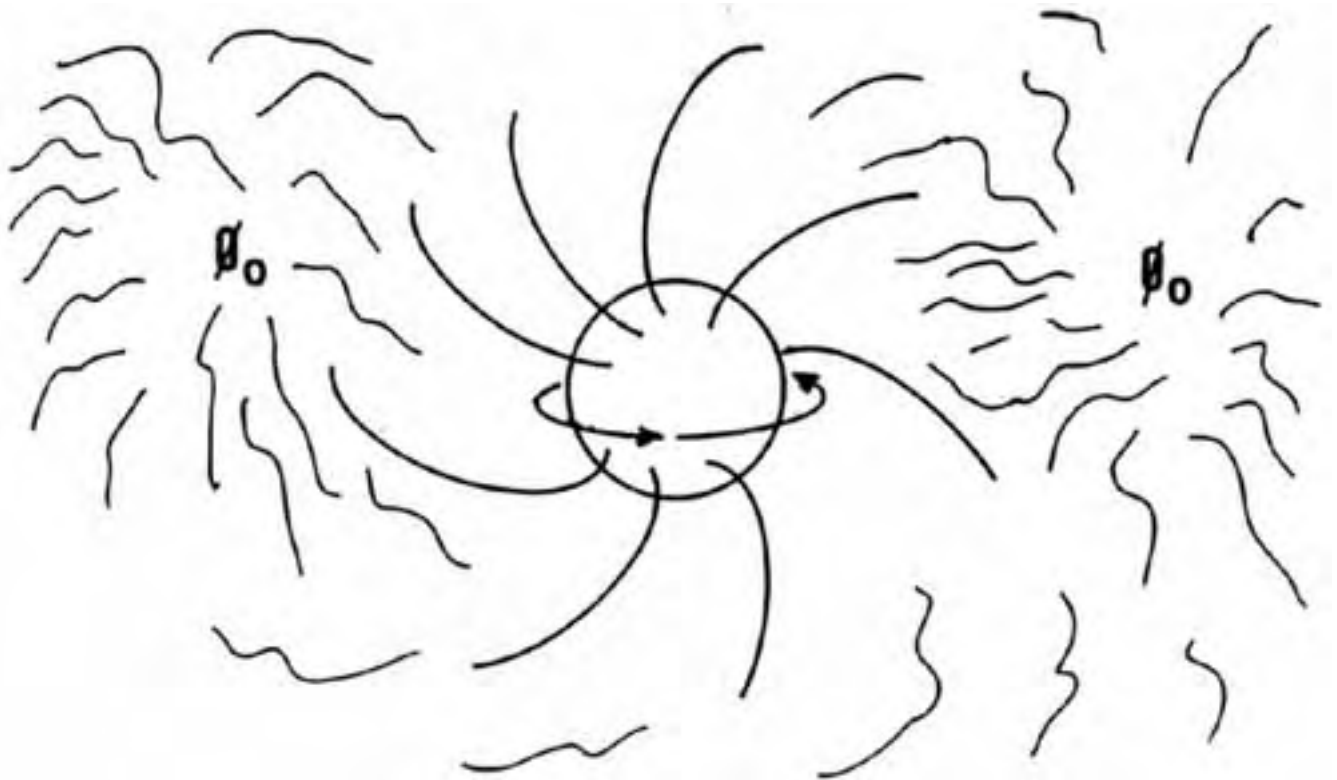

On this slide we accent that our 3-dimensional particle of mass is directly connected by its spin to the vacuum ether itself. To the virtual particle flux that identically IS the vacuum spacetime.

Interestingly, relativity states that the mass itself is nothing but a "kink" or curvature in spacetime .

The fact that the surface of the particle is spinning at right angles to the virtual particle vacuum flux "drags" part of the flux along with it, spiraling it, and certainly "kinking" or "bending" the vacuum flux .

That's the MECHANISM for the bending of spacetime. And that's what MAKES the particle of mass in the first place, and reduces its dimensionality to three.



Also note that the vacuum IS  $\phi$ -sub-zero, and that is never a zero value. This is contrary to present EM theory, which erroneously assumes  $\phi$ -sub-zero -- the charge of vacuum -- to be zero or non-existent.

[Next Slide](#)

SLIDE 27.

## **SPIN COUPLES VACUUM TO PARTICLE**

---

- **SPHERICAL ROTATION IS THE KEY**
- **A PARTICLE CAN BE MODELED AS  
A SPHERICALLY ROTATING VORTEX  
OF SPACETIME**
- **ITS MASS IS DUE TO ITS SPIN**
- **THE SPINNING OBJECT IS  
CONTINUALLY CONNECTED  
TO ITS ENVIRONMENT**
- **VERY HIGH VALUES OF  
ELECTROSTATIC POTENTIAL  
CAN INDUCE RELATIVISTIC  
CONDITIONS**
  - **CHANGE RATE OF FLOW  
OF TIME**
  - **EVEN THOUGH VELOCITY  
IS NONRELATIVISTIC**

E.P.BATTEY-PRATT AND T.J.RACEY  
"GEOMETRIC MODEL FOR FUNDAMENTAL  
PARTICLES,"  
INTL. J. OF PHYS. 19, No. 6, 437-475, 1980

In fact, the bits and pieces of many of the new concepts are strewn all through the scientific literature. Here we show one example, establishing a good model that spin of a particle couples the particle to the vacuum .

This paper is by E.P. Battey-Pratt and T.J. Racey, and was . published in the International Journal of Physics in 1980.

Note again that very high values of electrostatic potential can induce relativistic conditions, even though relativistic velocity is not present.

[Next Slide](#)

[The Tom Bearden Website](#)

SLIDE 28.

## ELECTRON PRECESSION (SIMPLIFIED)

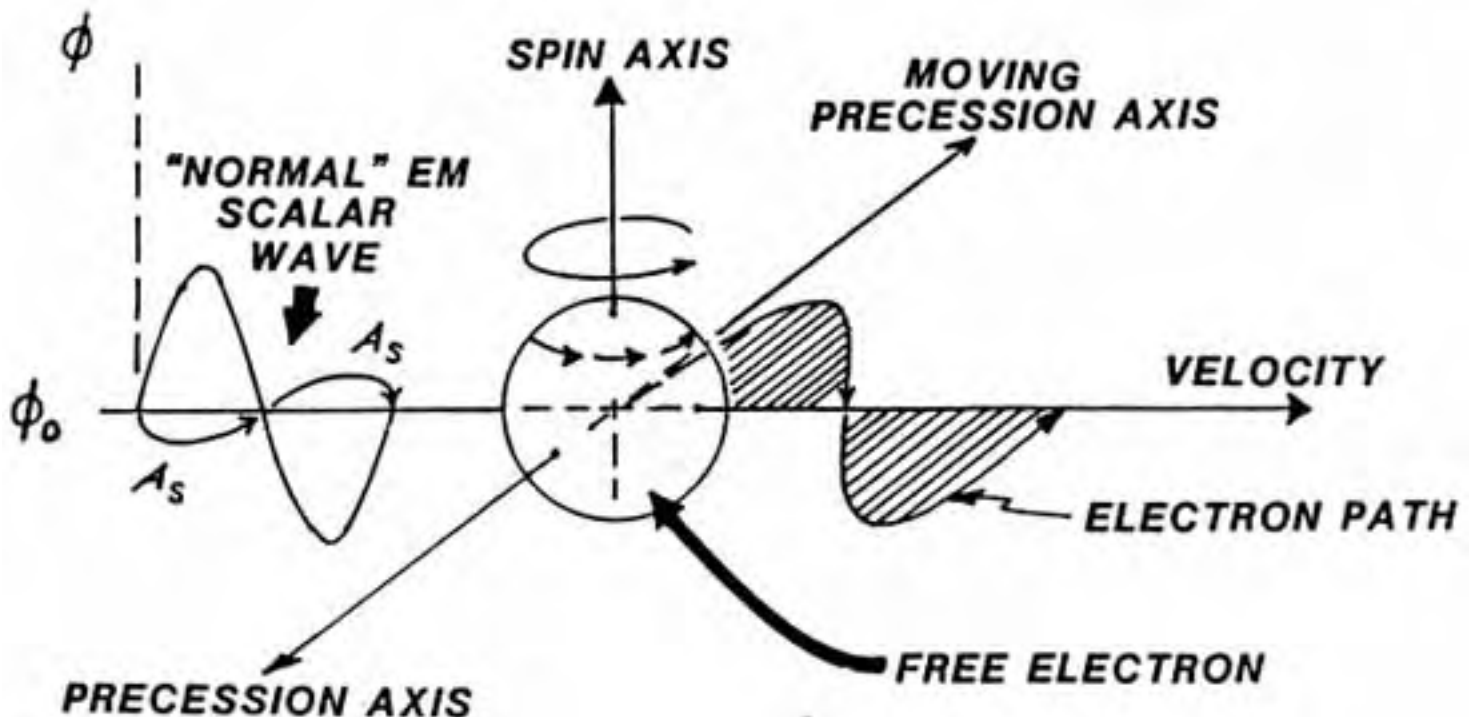

On this slide I show the effects of precession of an electron when it encounters a longitudinal scalar wave that contains "spin vortex holes" for the electrons to fall into and mesh its spin with.

The basic idea here -- that electron precession accounts for the Hertzian waves in the electron gas in a transmitting antenna and in a receiving antenna, came from my close colleague and friend, Frank Golden, and I am most happy to give him full credit for this important insight.

As we have previously stated, transverse (force) waves cannot exist in vacuum in the absence of mass. Hertz waves therefore cannot exist in vacuum, just as Tesla stated.

Yet we know that Hertz waves exist in the electron gas in

our transmitting antennas and in the electron gas in our receiving antennas. How then do we get Hertz waves here, if only longitudinal waves can exist in the vacuum in between?

Electron precession is the key.

We never measure what's happening in vacuum with our instruments. Instead, almost always we measure what is happening to and in the electron gas in our antenna or probe and feeding current to the instrument.

Here we show a "normal" EM vacuum wave -- which is a longitudinal wave containing spin vortexes from the electrons that generated it -- approaching and striking a spinning charged electron. As the peak and trough of the wave passes, it is as if we had a force pressing against the spinning electron, first along the line of wave travel, and then antiparallel to the wave travel. (*that is, "explaining" it in present concepts.*)

The electron acts as a little gyroscope, and precesses laterally, first in one direction and then the other.

Therefore the wave recovered in the electron gas in our receiving antenna or instrument probe is a transverse Hertzian matter wave.

Hertz waves are always matter vector waves.

Vacuum EM waves are always nonmaterial longitudinal scalar waves.

Longitudinal scalar waves in vacuum normally contain many spinning vortex "holes" of flux, created from the spinning electrons which launched the wave and stayed behind in the transmitting antenna. This kind of longitudinal wave is directly detectable by a normal free electron charged gas in a receiving antenna or probe. It also directly interacts with free electrons in a conducting metal shield, and so is shielded by Faraday cages.

On the other hand, our zero-vector longitudinal wave, made by opposing waves, contains opposing spin holes which annihilate or cancel each other.

In the absence of spin holes, the longitudinal wave will not mesh with spinning electrons in a conductor, and so it is not detectable in the normal fashion. It also does not interact with free electrons in a conducting metal shield, so it readily penetrates Faraday cages.

An easy way to see that electrons do not interact with that substructured longitudinal zero-vector wave is to visualize both substructure component waves interacting on the electron simultaneously, pushing in opposite directions equally. In that case the electron tries to precess in both directions, equally, and so it does not precess in either direction. Therefore it does not "detect" the passing wave.

The wave without "golf ball holes", however, is detectable by any circuit having high nonlinearity actions occurring in it. Such highly nonlinear dynamic areas act to provide a phase shifting between the composite substructure waves. This phase shift results in violation of the sum-zero condition, producing a "normal" EM wave which deposits energy in the out-of-phase area.

From the spin vortex "golf ball hole" concept, the out-of-phase condition means that now we have an alternating preponderance of spin holes, spinning first in one direction and then in the other. Thus the electrons in the nonlinear, phase shift area are hooked and oscillated (precessed) to and fro, producing energy.

Solid state, highly doped transistors are particularly vulnerable to this effect, as are gas discharge tubes, spark and cascade ion discharges, plasmas, etc.

[Next Slide](#)

SLIDE 29.

## **VACUUM/SPACETIME IS PURE VIRTUAL PARTICLE FLUX ( $\emptyset_0$ )**

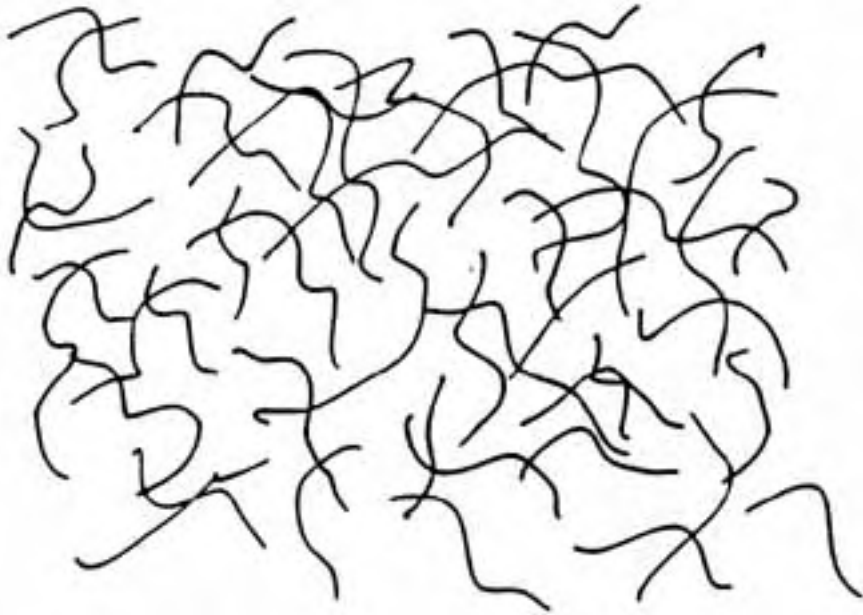

### VACUUM IS IDENTICAL TO:

- **VIRTUAL PARTICLE FLUX**
- **SPACETIME**
- **ANENERGY**
- $\emptyset_0$
- **MASSLESS CHARGE**

### VACUUM IS:

- **MADE OF UNQUANTIZED ACTION**
- **WITHOUT DEFINITE LENGTH INTERVALS**
- **WITHOUT DEFINITE TIME INTERVALS**
- **N-DIMENSIONAL (UNFIXED)**

We pause here to again summarize some important things we now know about vacuum.

Vacuum IS IDENTICAL TO virtual particle flux, spacetime, anenergy, Phi-subzero, massless charge, unquantized action, and infolded energy, momentum, length, time, power, velocity, acceleration, etc.

Vacuum is made of unquantized action, dimensionally.

It is without definite length or time, as Einstein stated.

It is n-dimensional, where n is always four or

greater.

It is not an emptiness filled with things. Rather, it is identically a plenum filled with things which are totally unseparated, unfixed, and undetermined.

From vacuum: mass, energy, time, frames, and all the rest of physical reality are dynamically made.

Vacuum is the ether. The ether has never been eliminated from physics. Ether just has become much more subtle, and physicists have used other names for it.

[Next Slide](#)



## VACUUM IS:

---

- **SPACETIME ( $L^nT$ , WHERE  $n \geq 3$ )**
- **CHARGE (MASSLESS)**
- **ELECTROSTATIC SCALAR POTENTIAL**  
 $\emptyset_0 \neq 0$
- **ERROR IN PRESENT THEORY**
- **BROKEN BITS OF ENERGY (SUBQUANTAL)**
- **PURE VIRTUAL PARTICLE FLUX**
- **O-WAVE FLUX**
- **MULTILEVEL, STRUCTURED, PATTERNED**
- **A VIRTUAL PLENUM**
- **AN OBSERVABLE EMPTINESS**

Again, we list some of the things that vacuum identically is.

It is spacetime, massless charge, electrostatic scalar potential, broken bits (subquantal) of energy, pure virtual particle flux, zero-vector wave flux, multilevel, structured, patterned, a virtual plenum, and an observable emptiness.

It is all things and contains all things in potential state.

It is not, in that it is not observable. But from it comes all observables.

It is both ordered and disordered, simultaneously.

It involves four-law logic, not just three-law  
Aristotelean logic.

[Next Slide](#)

SLIDE 31.

## GRADIENT OF ELECTROSTATIC POTENTIAL

---

IN VACUUM

$$\nabla\phi \neq \ddot{\mathbf{E}}$$

ON AND OF A MOVING CHARGED PARTICLE

$$\nabla\phi = \ddot{\mathbf{E}}$$

Again I accent that, in vacuum in the absence of a charged spinning particle of observable mass,  $\nabla\phi$  does not yield an  $\ddot{\mathbf{E}}$ -field, and the conventional equations of EM are wrong in that respect.

In the presence of a spinning charged particle, in a  $\nabla\phi$  which contains electron-vortex-holes to mesh with, the charged particle attaches itself to the moving  $\nabla\phi$  flux gradient, moving itself with the river. This produces an  $\ddot{\mathbf{E}}$  field. The  $\ddot{\mathbf{E}}$ -field CONSISTS OF the smeared electron, it does not CAUSE THE MOVEMENT of the electron. It is an effect, not a cause. The conventional equation for  $\nabla\phi$  equals  $\mathbf{E}$  is correct for matter waves in electron gases; it is not correct in vacuum itself.

[Next Slide](#)

[The Tom Bearden Website](#)

SLIDE 32.

**IN A  $\nabla\phi$ , A CHARGED PARTICLE MOVES ITSELF**

**$\nabla\phi > 0$  IMPLIES A MOVING RIVER, AND THE CHARGED PARTICLE IS "HOOKED TO" THE RIVER**

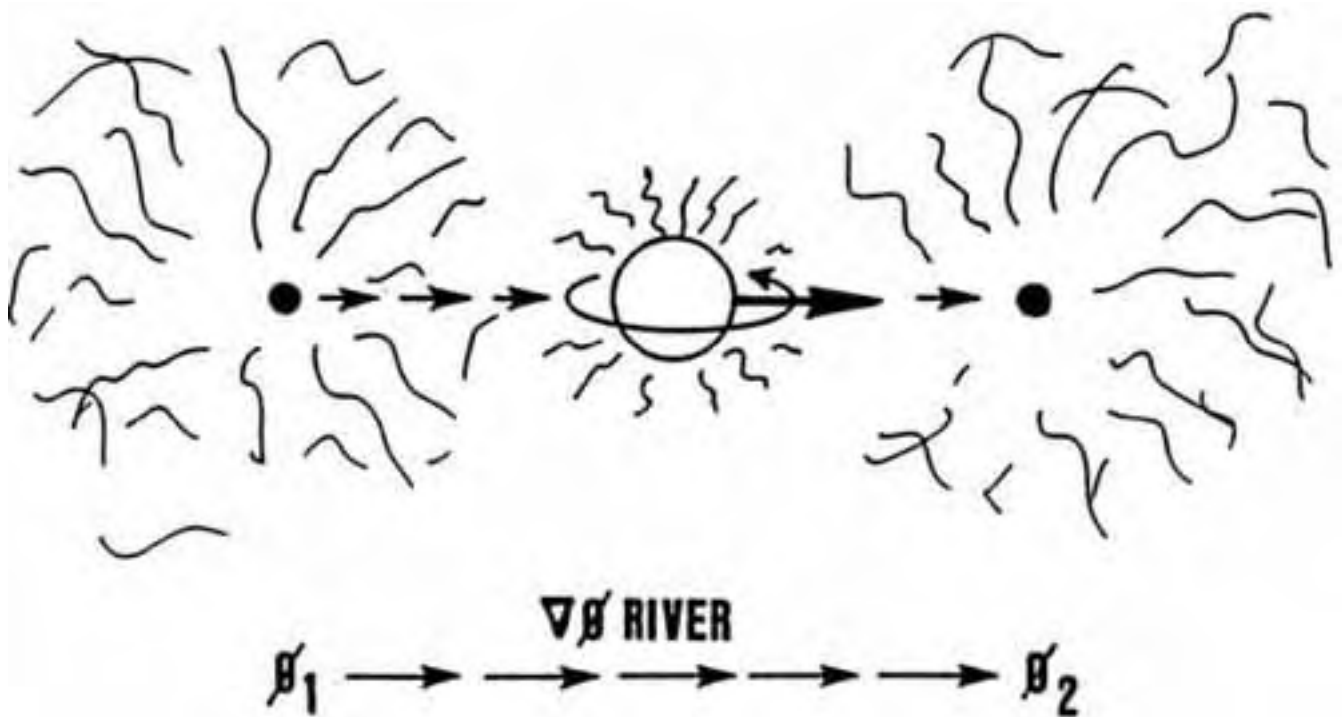

We show clearly on this slide that a spinning charged particle, when it hooks to a spin-hole in a del-phi river, MOVES ITSELF.

Note that a del-phi implies a "pressure difference" in phi-flux between two points. Therefore there is a moving river -- a gradient -- of phi-dot, moving from the higher pressure to the lower.

If a charged particle is attached to this moving river, it flows along with the river. It is just like putting a boat into a moving stream of water. If the boat "latches" to the moving water, it moves with the river.

Electron spin and spin vortexes in the del-phi mesh, to accomplish the "hooking" or "latching."

Once hooked into a moving river, the electron moves itself. One does not have to furnish work to move it.

If the river is accelerating, the electron will accelerate itself.

By cleverly gating such rivers into and onto sources of free electrons, one can directly produce free energy.

The extra energy comes from converting an energy (massless charge, vacuum flux) to energy of a moving mass.

[Next Slide](#)

SLIDE 33.

## **ELECTROMAGNETIC WAVES IN ELECTRON GAS IN A CONDUCTOR**

---

- **VECTOR WAVES**
- **CONTAIN E, B FIELDS**
- **GENERATED BY SPIN COUPLING  
OF ELECTRONS  
WITH SCALAR WAVE "SPIN-  
HOLES"**
- **WAVES OF FORCE**
- **HERTZIAN WAVES**
- **TRANSVERSE WAVES**
- **WAVES OF ELECTRON  
PRECESSION**

Here we pause to summarize the characteristics of electromagnetic waves in the electron gas of a conductor.

First, these are vector EM waves in the accepted sense.

They contain E and B fields.

They are generated by spin coupling of electrons with spin-holes in a scalar wave  $\Delta\phi$  river. The electrons move themselves under that condition, producing work and forces.

They are waves of force or force field variations.

They are Hertzian waves.

They are transverse oscillatory, not longitudinal.

They are matter waves.

They are waves of electron precession.

[Next Slide](#)

## ELECTROMAGNETIC WAVES IN VACUUM

---

- **SCALAR LONGITUDINAL WAVES**
- **VECTOR ZERO [Ö] WAVES**
- **WITHOUT  $\vec{E}$ ,  $\vec{B}$  FIELDS**
- **INTERNALLY STRUCTURED**
- **PATTERNED**
- **MAY CONTAIN ELECTRON "SPIN-HOLES"**

Here we summarize the characteristics of electromagnetic waves in vacuum.

They are scalar longitudinal waves of alternate compression and rarefaction of the vacuum virtual particle flux.

That is, they are waves of electrostatic potential.

They are zero-vector waves.

They are internally structured and patterned.

They usually contain electron "spin holes" unless made in a fashion so as to make opposing spin holes that cancel each other.

Since they are pure phi-waves, they need not be limited in velocity to the speed of light.

They are hyperspatial waves.

They are waves in virtual state itself.



[Next Slide](#)

[The Tom Bearden Website](#)

SLIDE 35.

## DETECTION OF TRANSVERSE AND LONGITUDINAL WAVES

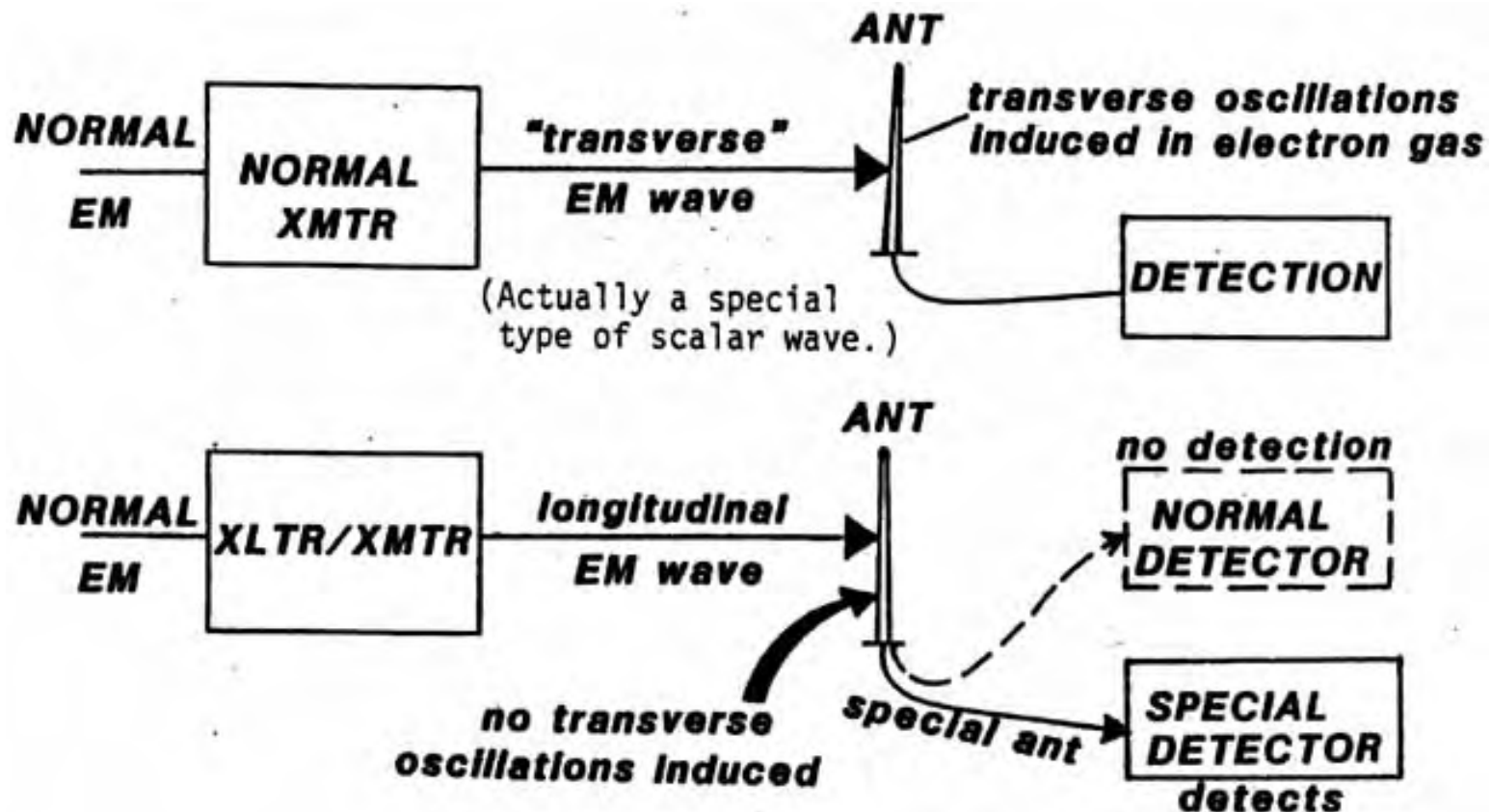

In the top drawing on this slide, we show a normal transmitter putting out a normal EM wave, which is received in a normal antenna/receiver. What we call a "transverse" wave rigorously exists only in the electron gas in the transmitting antenna and in the electron gas in the receiving antenna. Specifically, a longitudinal wave exists in the vacuum in between the two antennas. However, due to the method of production, the longitudinal wave contains spin-holes for electrons, so the electrons in the receiving antenna readily couple with the wave by falling into and meshing their spins with the spins of the spin-vortex holes. Electron precession produces electron gas waves that are transverse oscillatory, hence Hertzian waves in nature.

In the bottom drawing, we show a translator/

transmitter. In other words, we oppose ordinary EM waves in a sum-zero substructure, deliberately producing longitudinal EM waves in vacuum with the spin-hole vortexes canceling each other. This type of wave does not "hook" spinning electrons in the normal receiving antenna, and thus it is not detected. The normal antenna/receiver system never sees it at all.

However, by means of a special antenna which generates nonlinear phase shifts in the composite substructure waves, "hooking" holes are restored in an oscillatory nature. Electrons then hook with this output and detect the wave.

Note that it requires a two-stage detector, operated in an interferometer fashion, to detect this pure scalar wave.

[Next Slide](#)

## CREATING A "RIVER" OF ANENERGY

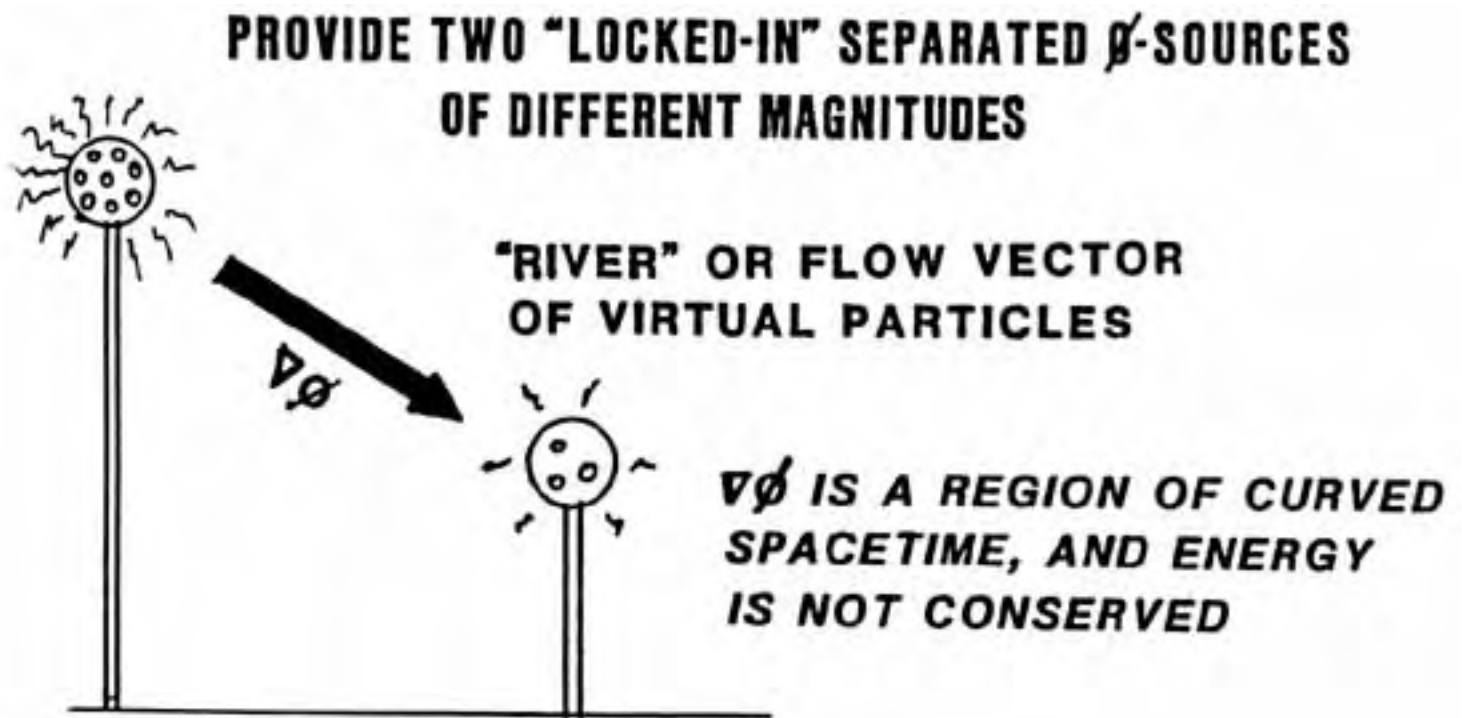

**IN VACUUM, THIS IS NOT YET A VOLTAGE DROP (NO MASS FLOW), NOR IS THERE AN  $\dot{E}$ -FIELD**

Now if we wish to get free energy, we are going to have to provide a continuous anenergy river, and a means of tapping it to produce mass movement.

This slide shows one easy way to make an anenergy river.

We simply pump some electrons (spray nozzles) onto an elevated charged ball, and we LEAVE them there. A second ball is connected to ground. A higher phi -- that is, a denser spray -- is now in the vicinity of the elevated ball on the left. A lower phi -- that is, a less dense spray -- is in the vicinity of the lower ball on the right. Between the two balls, now, there is a

gradient in  $\phi$ , and a virtual flux flowing from the "higher virtual pressure" to the "lower virtual pressure."

This  $\nabla\phi$  river does NOT constitute an  $\ddot{E}$ -field, as we have previously pointed out.

The  $\nabla\phi$  region, however, is definitely a region of curved spacetime. As is well known from general relativity, in such a region energy need not be conserved.

Therefore it is entirely possible -- consistent with ordinary physics -- to violate conservation of energy in this  $\nabla\phi$  river, if one believes general relativity. If one argues adamantly that conservation of energy cannot be violated under any circumstances, then one must throw out general relativity. Also, one must throw out most of particle physics, whose explanations presently involve virtual interactions, each of which violates the conservation of energy.

[Next Slide](#)

## A 2-WIRE SYSTEM IS CONSERVATIVE

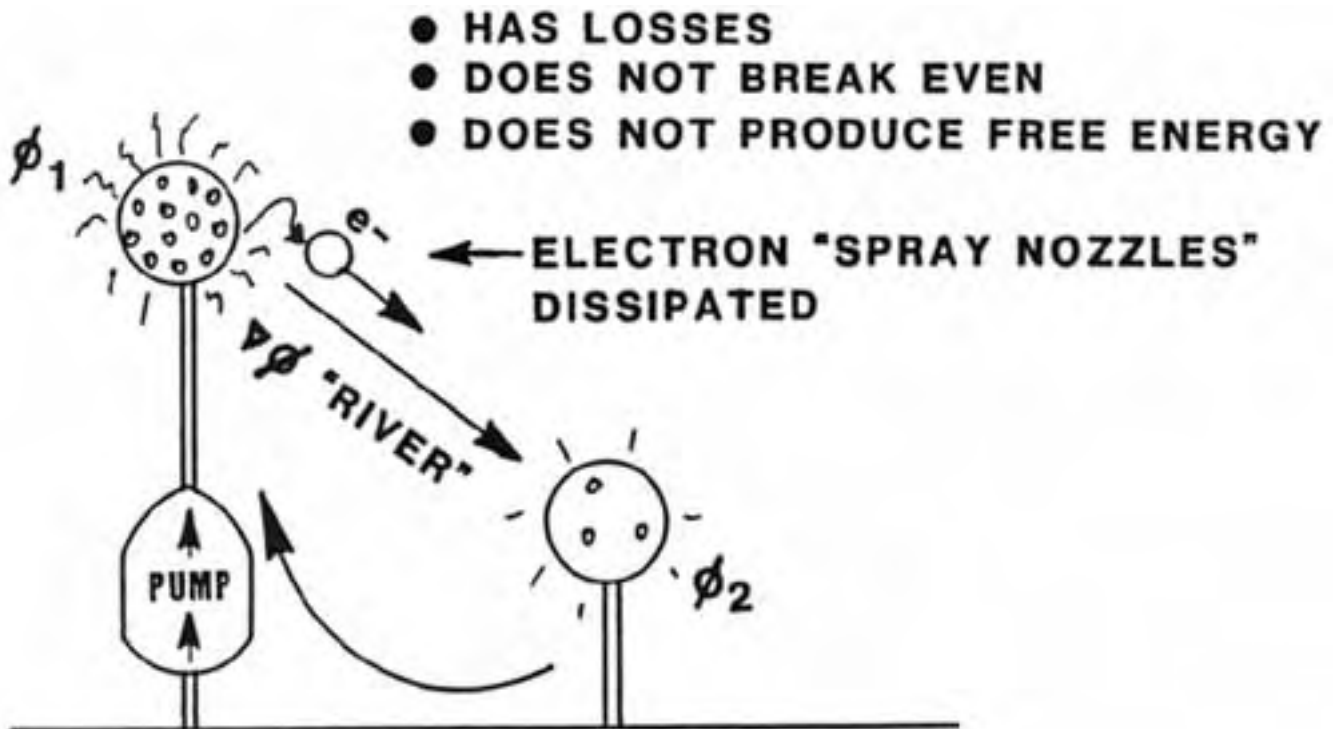

**REPLENISH SPRAY NOZZLES BY PUMPING MORE ELECTRONS. (MOVING ELECTRON MASSES AGAINST A "SPRAY PILEUP" REQUIRES WORK.)**

Here we show that, as engineers, we've all been tricked into releasing our virtual rivers so that we would not discover free energy.

While I cannot prove this as yet, I tentatively suspect that J. P. Morgan and Thomas Edison are directly responsible for this occurring. [Tesla utilized a single-wire system](#); we have all been taught to utilize only two-wire systems.

What we in effect do is connect a wire or circuit to our charged ball, allowing our hose nozzles to drain away.

In other words, we first do some work to pump hose nozzles (electrons) into and onto our elevated

reservoir, so we will obtain a denser flux, and a flux river to utilize. Then we release the nozzles themselves, and let THEM move on the flux river, depleting our river. Of course we can get back as much energy as we pumped up there in the first place. But this two-wire system is at best theoretically even. Since real circuits have losses, we can never even quite break even. Thus we have to continue to pump hose nozzles, and let them bleed off to provide energy, in a less-than-100% fashion.

By foolishly releasing our hose nozzles, we guarantee that we will never achieve free energy. And that's nice, because the people who control things, and for their own wealth and power depend on selling us energy at high prices, are guaranteed to stay in power and control.

One is never truly free unless one is energy independent, in a self-contained fashion.

Tesla nearly succeeded in giving us free or very cheap, inexhaustible energy -- and for that reason was quickly and dramatically suppressed.

Only three graduate schools of electrical engineering existed in the U.S. The only one of any real importance was at Columbia University.

Only one or two professors were necessary to "reach" to modify and subtly direct the entire foundations of the emerging electrical theory.

Professors were in general poor, and had no research funds unless some rich industrialist or philanthropist gave them a few dollars.

The setup then was certainly very ripe for Morgan and Edison to stop free energy, and suppress Tesla at the same time. They could have done so by influencing only one -- or at most two -- theoreticians at Columbia.

At any rate, the theory was developed in such fashion as to rule out the single wire circuit and the longitudinal wave. Free energy was suppressed, and the financial empires of Morgan and Edison stayed secure.

[Next Slide](#)

[The Tom Bearden Website](#)

SLIDE 38.

## A HOLLOW CHARGED SPHERE

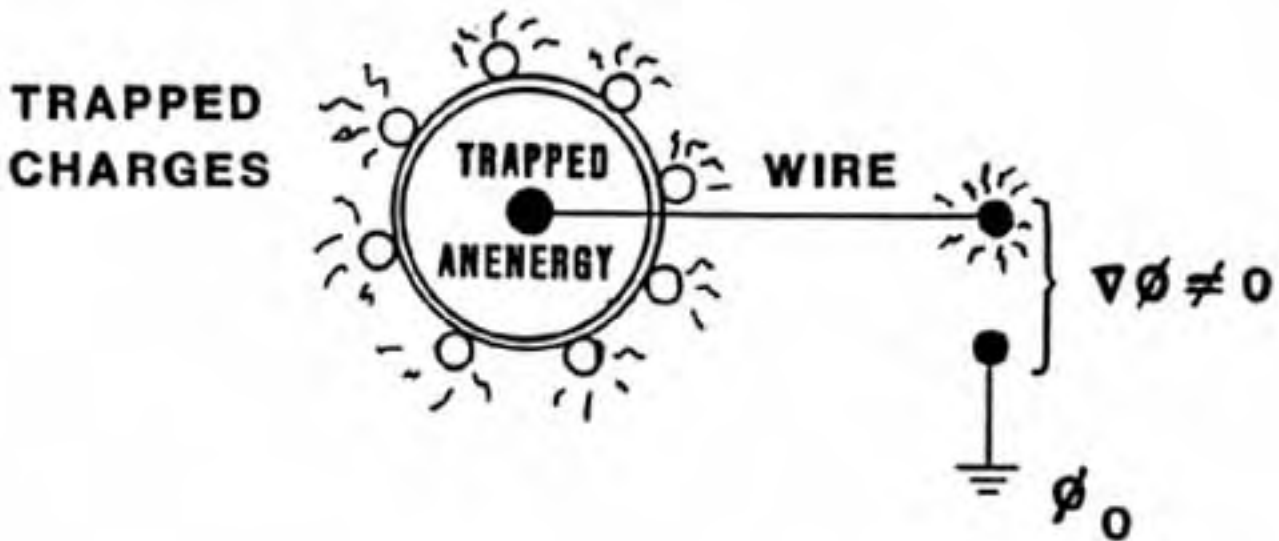
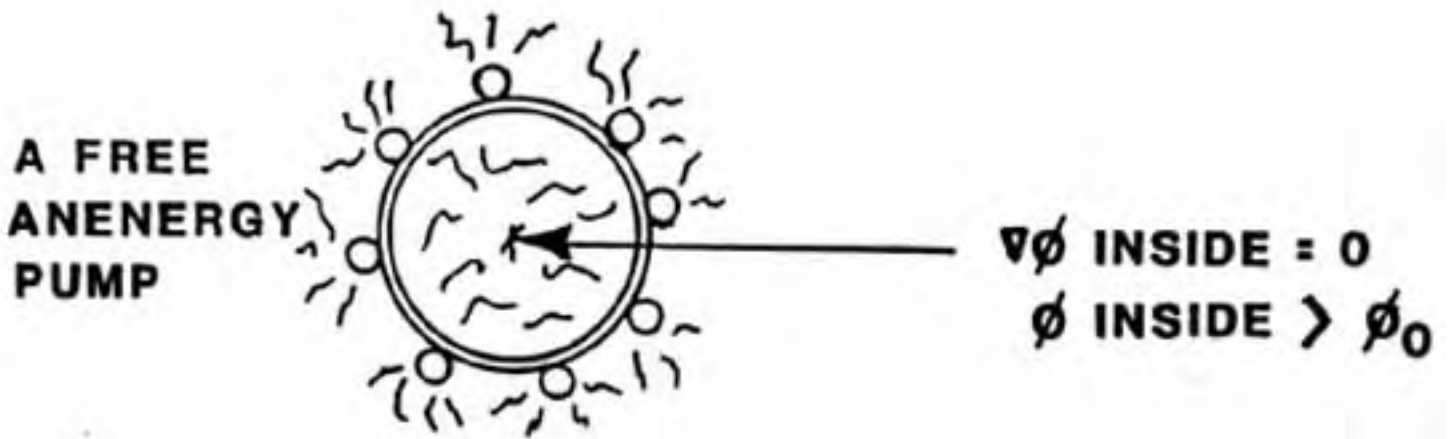



Here we show another easy source of a higher vacuum charge, hence an easy source for a free river.

Simply charge up a sphere. As is well known, inside that sphere one has no del-phi. So one can introduce an electron therein and not produce an  $\ddot{E}$ -field .

However, since we've piled up additional spray nozzles, the density of the spray inside the sphere (as well as outside it) is certainly higher.

In other words, the inside of the sphere is also a source for an increased del-phi river. In the bottom drawing, we drill a tiny hole in the sphere, insulate a thin wire running into the inside of the sphere, and run the wire out to a terminal opposing another grounded terminal. Between the two terminals now there must exist a del-phi river.

And between those terminals there now exists a curvature of spacetime, hence the theoretical possibility to obtain free energy without violation of principles.

[Next Slide](#)

[The Tom Bearden Website](#)

SLIDE 39.

## ONE-WAY GATE VALVE

(ANENERGY TO ENERGY)

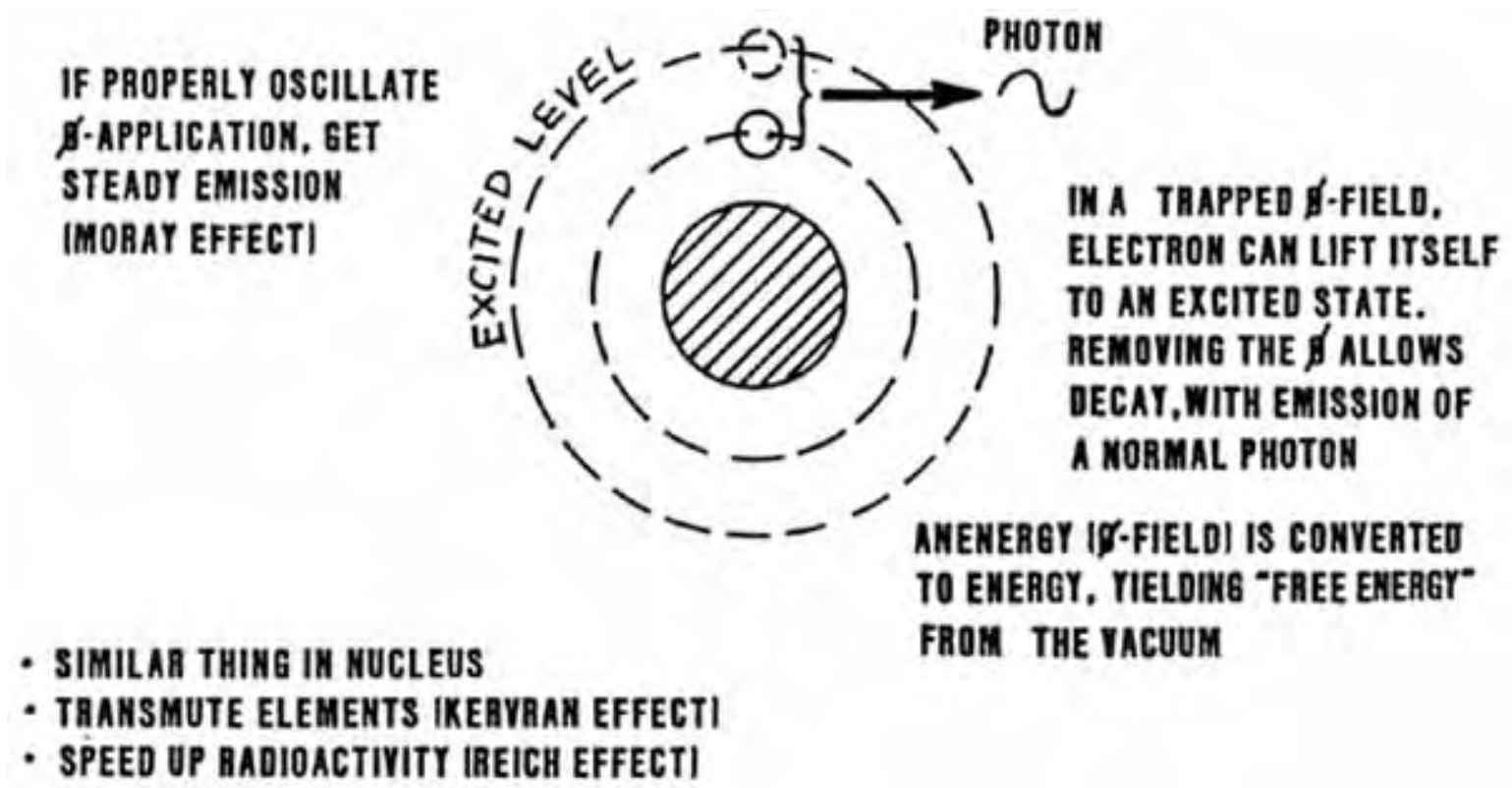

Here we show one way to provide a one-way gate valve from a del-phi river to energy released into the outside world.

By providing a properly tuned, oscillating phi wave, one can cause an orbital electron in an atom to raise itself to an excited state. Remember, in a del-phi, an electron that hooks to it raises itself.

We then switch out the phi application, and the excited electron decays in normal fashion, emitting a normal photon of energy.

By phase locking the processes, one produces a steady stream of photons.

By absorbing or directing the photons, one can

produce heat, light, energy beams, etc.

By this means, one produces free energy by gating anenergy into energy.

And if one does not release spray nozzles in the phi-oscillations which feed the mechanism, one has an inexhaustible energy production.

A very similar thing can be done with the excited states of the nucleus. For example, by using a radioactive material with a predisposition to emit some particle -- say an electron -- the nucleus can be made to continually emit the particles WITHOUT ITSELF DECAYING INTO BYPRODUCTS. In other words, an electron is lifted from the Dirac sea of vacuum to instantly replace the electron emitted from the nucleus.

This provides a one-way gate valve from the Dirac sea to the external universe.

Theoretically, these mechanisms are no more mysterious than a hydraulic ram, which raises water higher than the stream that feeds the ram.

In the 20's and 30's, T. Henry Moray successfully built such gating devices for converting vacuum anenergy to external energy.

In the Kervran effect, living systems are able to directly transmute elements, even though they only possess feeble energies, by influencing the virtual particle interactions in the nucleus that furnish its binding energy.

Reich used an adaptation of a [cloudbuster](#) -- which emits scalar waves -- to drastically speed up radioactive decay of radioelements.

Both plants and animals transmute elements by similar processes.

[Next Slide](#)

TOWARDS A NEW ELECTROMAGNETICS  
PART 4: VECTORS AND MECHANISMS CLARIFIED

SLIDE 40.

**SIMPLE FREE ENERGY MOTOR**

**BATTERY RECHARGES ITSELF**

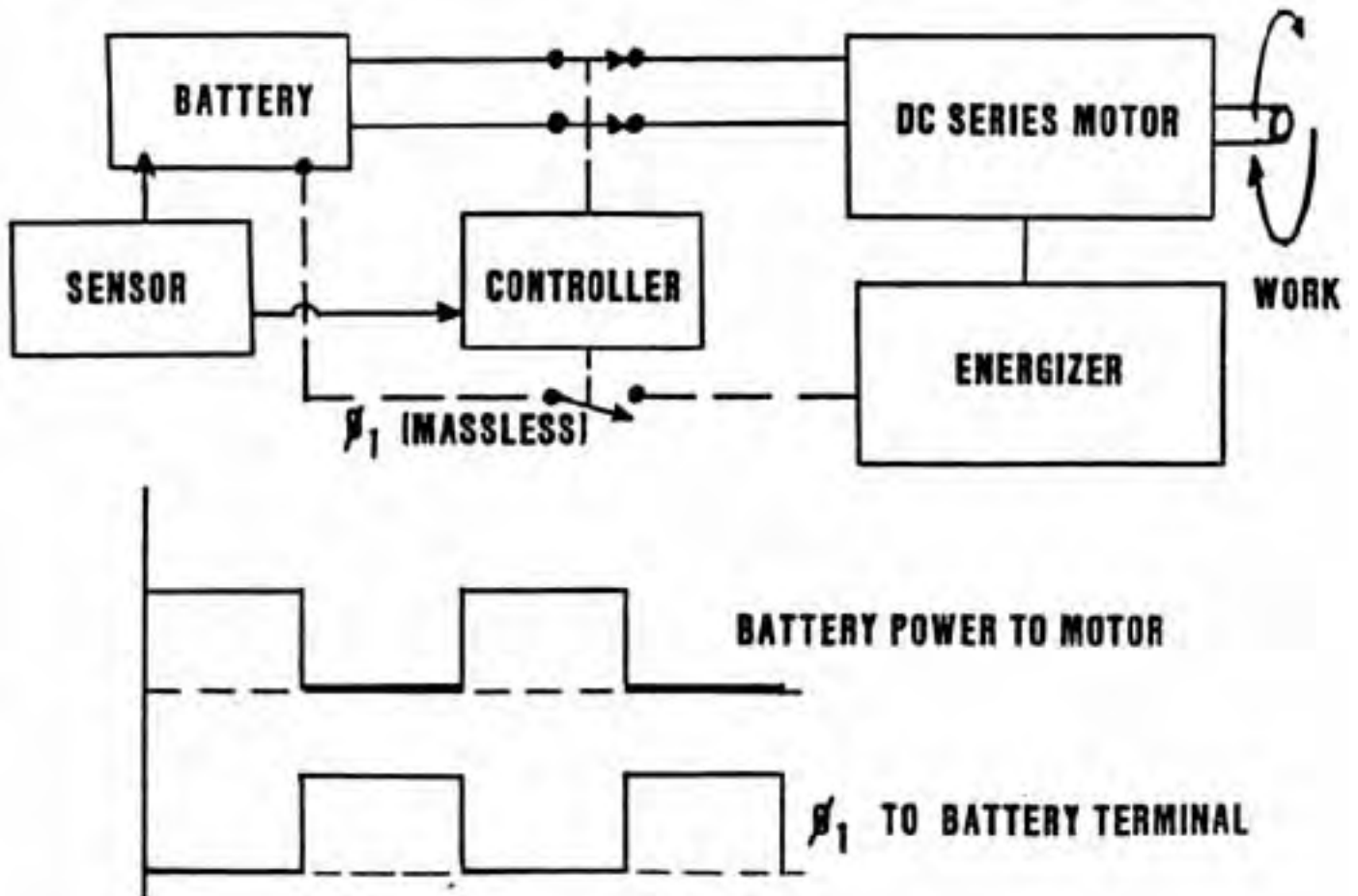

On this slide, we show a theoretical scheme which several researchers have discovered and used to build simple free energy motors.

In this scheme, we drive an ordinary d.c. series motor by a two wire system from an ordinary battery. The motor produces shaft horsepower, at -- say -- some 30 or 40 percent efficiency, compared to the power drained from the battery. This much of the circuit is perfectly ordinary.

The trick here is to get the battery to recharge itself, without furnishing normal power to it, or expending work from the external circuit in the process.

To do this, recall that a charged particle in a "hooking" del-phi river moves itself. This is true for an ion, as well as for an electron. We need only make the del-phi in correct fashion and synchronize it; specifically, we must not release the hose nozzles we utilize to produce our del-phi river or waves.

The inventors who have discovered this have used various variations, but here we show a common one.

First, we add an "energizer" (often referred to by various other names) to the circuit. This device makes the del-phi waves we will utilize, but does NOT make currents of electron masses. In other words, it makes pure  $\emptyset$ -dot. It takes a little work to do this, for the energizer circuit must pump a few charges now and then. So the energizer draws a little bit of power from the motor, but not very much.

Now we add a switching device, called a controller, which breaks up power to the motor in pulses. During one pulse, the battery is connected and furnishes power to the motor; during the succeeding pulse, the battery is disconnected completely from the motor and the output from the energizer is applied across the terminals of the battery.

If frequency content, spin-hole content, etc. are properly constructed by the energizer, then the ion movements in the battery reverse themselves, recharging the battery. Again, remember that these ions MOVE THEMSELVES during this recharge phase. Specifically, we are NOT furnishing ordinary current to the battery, and we are not doing work on it from the energizer.

If things are built properly, the battery can be made to more than recover its charge during this pulse

cycle.

To prevent excess charge of the battery and overheating and destroying it, a sensor is added which senses the state of charge of the battery, and furnishes a feedback signal to the controller to regulate the length of recharge time per "power off" pulse. In other words, the system is now self-regulating.

The relation between power pulses and recharge pulses is shown on the graphs at the bottom. Note that regulation may decrease the time of recharge application of the del-phi river.

This system, if properly built and tuned, will furnish "free shaft energy" continually, without violating conservation of anenergy. Remember that the del-phi condition across the battery terminals means that spacetime is suddenly curved there, and conservation of energy need no longer apply.

Again, this system is consistent with general relativity and with the fact that  $\emptyset$ -field alone can drive a situation relativistic. We have deliberately used these facts to do direct engineering. Our "extra energy" comes from shifting phi-flux -- the energy of the universal vacuum spacetime -- directly into ordinary energy for our use. Thus we draw on an inexhaustible source, and our device is no more esoteric than a paddlewheel in a river. The only difference is that, in this case, we have to be clever enough to make and divert the river in the right timing sequency.

This is a free energy device which an ordinary person, who knows a little electronics, can experiment with in the basement. To develop it, one is talking several thousands of dollars and a lot of persistence and tinkering; one is not talking millions.

---

**WARNING: THE PRECEDING EXPERIMENTS ARE HAZARDOUS. DO NOT ATTEMPT THESE EXPERIMENTS UNDER ANY CIRCUMSTANCES UNLESS YOU ARE AN EXPERIENCED ELECTRICAL RESEARCHER, EXPERIENCED IN PERFORMING EXPERIMENTS WITH LEAD-ACID BATTERIES AND PULSE CHARGE AND DISCHARGE OF SAME, AND UNLESS YOU ALSO USE ALL SAFETY PRECAUTIONS SUCH AS GOGGLES**

**AND PROTECTIVE GLOVES, SLEEVES, AND APRON. YOU MUST NOT HAVE OTHER INFLAMMABLE LIQUIDS OR OTHER SUBSTANCES PRESENT WHICH COULD BE IGNITED AND BURN OR EXPLODE. SURGED LEAD-ACID BATTERIES PRODUCE HYDROGEN GAS, WHICH CAN EASILY EXPLODE SINCE SPARKING ALSO CAN OCCUR. THE ACID FROM SUCH AN EXPLOSION CAN EASILY BLIND YOU IF IT GETS IN YOUR EYES, AND IT CAN BURN YOUR SKIN. IN ADDITION, LEAD AND LEAD COMPOUNDS ARE POISONS, AND ARE TO BE HANDLED ONLY BY EXPERIENCED RESEARCHERS. THESE EXPERIMENTS ARE NOT FOR AMATEURS UNDER ANY CIRCUMSTANCE, BUT ONLY FOR EXPERIENCED PROFESSIONALS WITH PROPER KNOWLEDGE AND TRAINING, AND USING PROPER PRECAUTIONS. NEITHER THE AUTHOR NOR THE PUBLISHER IS REPOSNSIBLE OR LIABLE FOR ANY ACCIDENTS OR DAMAGE YOU MAY ENCOUNTER, AND ALL EXPERIMENTATION WITH THESE DEVICES AND PROCEDURES IS AT YOUR OWN ASSUMED PERSONAL RISK.**

[Next Slide](#)

[The Tom Bearden Website](#)

SLIDE 41.

## THE TRANSLATOR

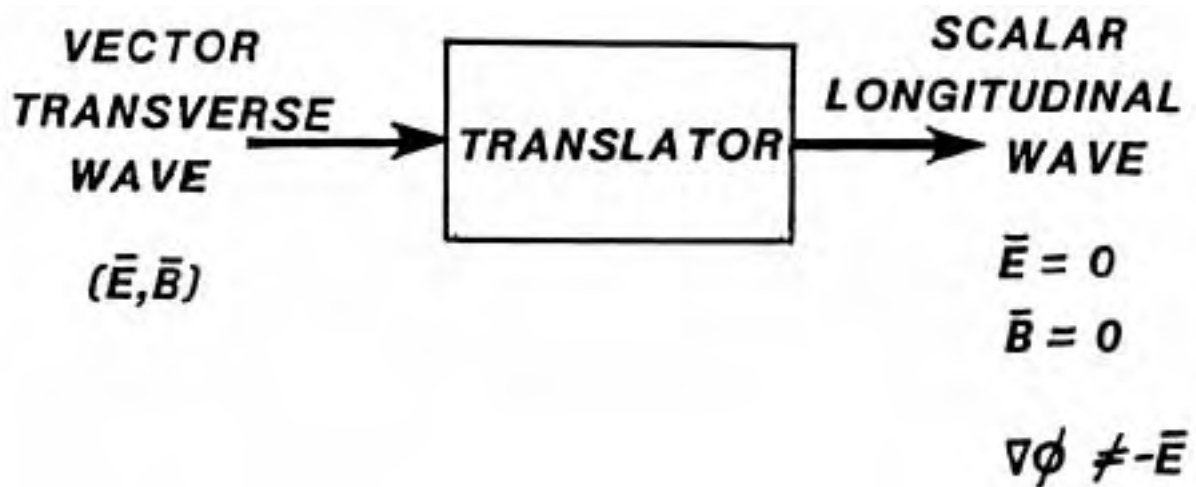

We now turn to a fundamental concept we need in order to understand some of the effects used by the Soviets in their Tesla weapons.

Note that one other country -- one not hostile to the U.S. -- also has such weaponry.

This slide shows the concept of a TRANSLATOR. Briefly, if we input a transverse matter wave, the translator outputs a scalar longitudinal wave without spin vortex hooks. If we input a scalar longitudinal wave -- even one without hooks -- the translator puts out a normal vector transverse matter wave.

We define a translator as anything which will accomplish one or both of those functions (usually both).

Basically, any device which is TOTALLY nonlinear to transverse waves will produce scalar waves from a transverse wave input. Any device which is totally nonlinear to longitudinal waves will produce transverse waves from a longitudinal wave



input.

It is comparable to certain plasmas, which, as is well known, produce such a translator effect. If you input longitudinal waves, you get transverse waves. If you input transverse waves, you get longitudinal waves. And the plasma is rather totally nonlinear.

Again, if our translator outputs non-hooking waves, it means that the component substructure waves oppose each other in sum zero fashion, and "kill" or nullify the vortex spin-holes.

[Next Slide](#)

[The Tom Bearden Website](#)

SLIDE 42.

## TRANSVERSE WAVE INTERFERENCE

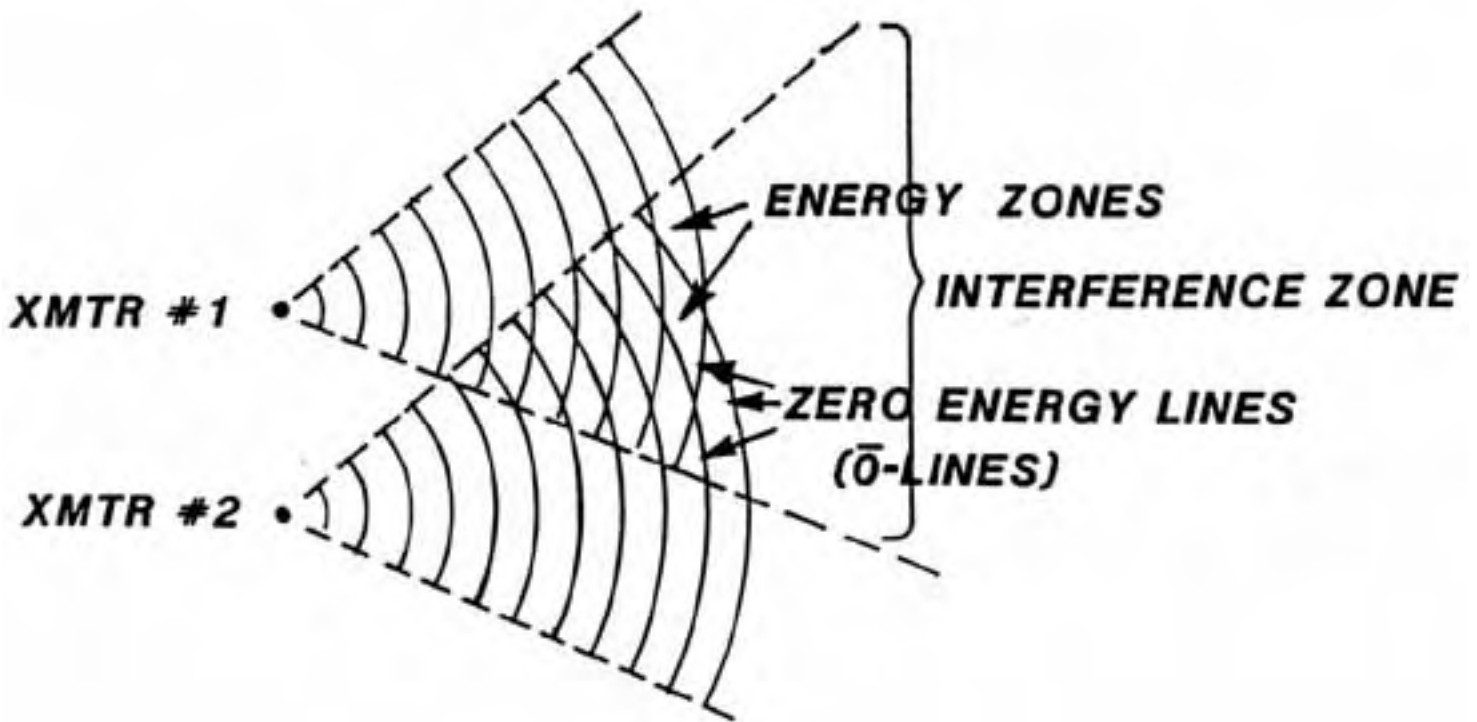

On this slide we show "normal " transverse wave interference, as we presently teach it in our textbooks.

We visualize two identical transmitters, each producing a beam in a pattern of about 55 degrees of so.

Where these beams overlap -- in the ideal, perfect case, we have constructive and destructive interference, with absolute zero-vector linear regions being formed. We put in the energy, and out-of-phase interference creates the zero zones, which contain no energy as such.

We point out, however, that these zero-lines are scalars, and contain high stresses on spacetime.

[Next Slide](#)



SLIDE 43.

## LONGITUDINAL WAVE INTERFERENCE [SCALAR WAVES]

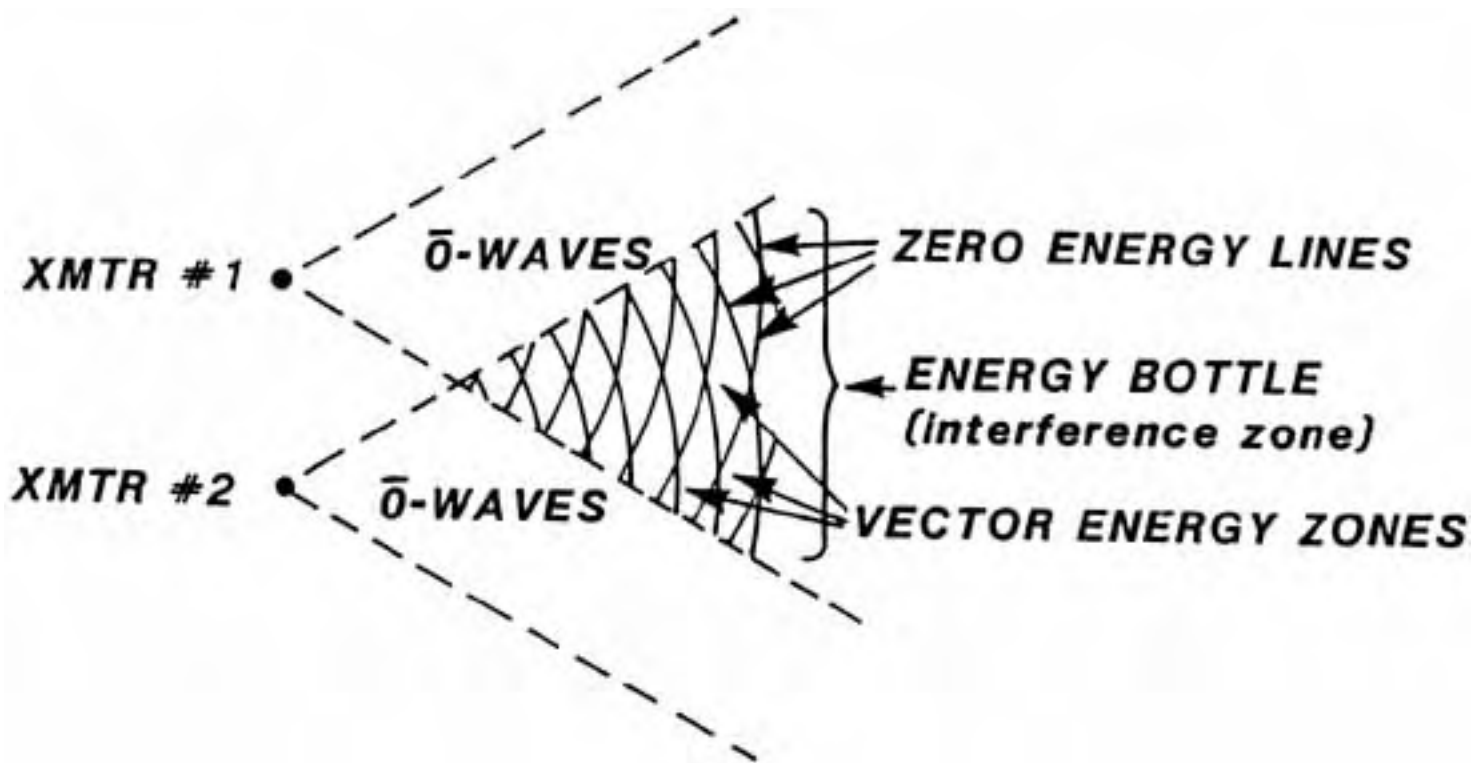

On this slide we show the interference pattern that emerges from the interference of two identical scalar wave beams from translator/transmitters.

Now note we are interfering two zero-vector waves, each containing a substructure. In this case we assume similar substructures.

What happens now is that we get a similar interference pattern, but with some startling differences.

First, we put in the zero-lines. These represent in-phase conditions for the substructures.

Second, the substructures themselves interfere, and form energy in the grid zones between intersecting zero-lines.

In the perfect case, however, this energy cannot

radiate away. It is physically created and trapped as if in an "energy bottle." We are CREATING this energy at a distance, and storing it in a bottle. If the bottle were perfect, we would continue to accumulate energy in the grid zones -- notice we are continuing to pour energy into both transmitters, and there is zero ordinary energy anywhere else except in the grid zone "bottles."

If we turn off the transmitters smoothly, we extinguish the energy in the bottle completely. It is sucked right out of there, and the vacuum returns to its normal condition.

If we erratically and nonlinearly turn off the transmitters, we destroy the bottle and "dump" the energy suddenly. This is exactly like a sudden EMP from a nuclear weapon. A sudden pulse of energy is freed to radiate and interact in the region where the bottle was.

The high altitude booms off the East coast of the U.S. a few years ago were made in precisely this fashion, from such a weapon being adjusted and calibrated in the Soviet Union.

[Next Slide](#)

## CREATING ENERGY AT A DISTANCE

### (Use of Hidden Information Content of the Field) (Can Provide Action-at-a-Distance)

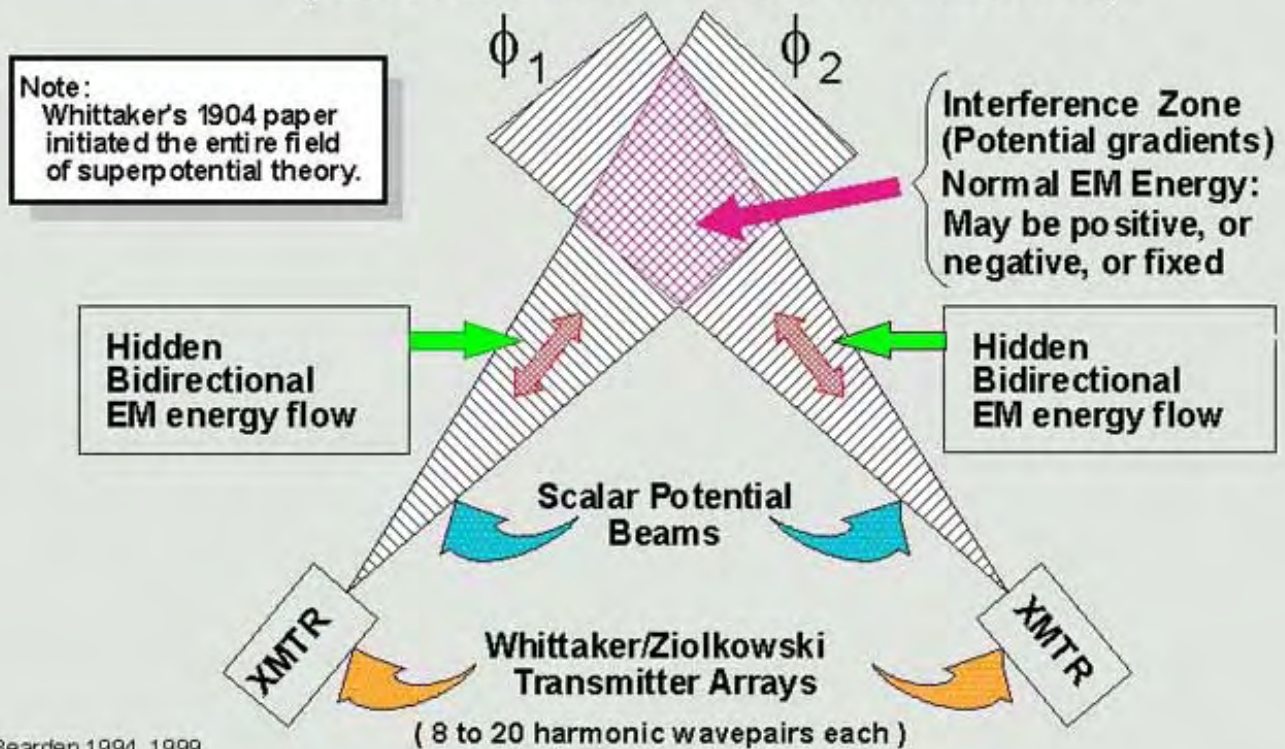

© T. E. Bearden 1994, 1999

**Figure 5. Scalar potential interferometry (between the two sets of bidirectional longitudinal EM wavepair functions) produces all EM force fields and waves.**

But let us look at one way to do this sort of thing more efficiently.

Here we show two scalar transmitters (that is, two translator/transmitters) which form narrow beams, and which cross those beams at a distance.

In the crossing zone, scalar interference is established, making an energy bottle and producing trapped or locked in energy.

If I have a physical target in that crossed zone, I can literally "fry" the target, for I get all the power inputted to the transmitters contained in the bottle zone. I don't have any square law losses.

I can heat a metal object white hot at a distance, for example. Because all real bottles are slightly imperfect, the real bottle is leaky and some photons escape. I can observe the white hot steel in the bottle,

and I can record and measure the temperature from the escaping photons, by simple radiometric methods.

Now if I smoothly turn off both transmitters linearly, all the energy in the bottle disappears immediately. I can immediately reach in and pick up a black, cool piece of steel. And that cannot be done with ordinary inductive or radiowave heating.

That has been done in a laboratory on the North American continent.

[Next Slide](#)

## NONLINEARITIES CAUSE SHIFTING [PARTIAL TRANSLATION]

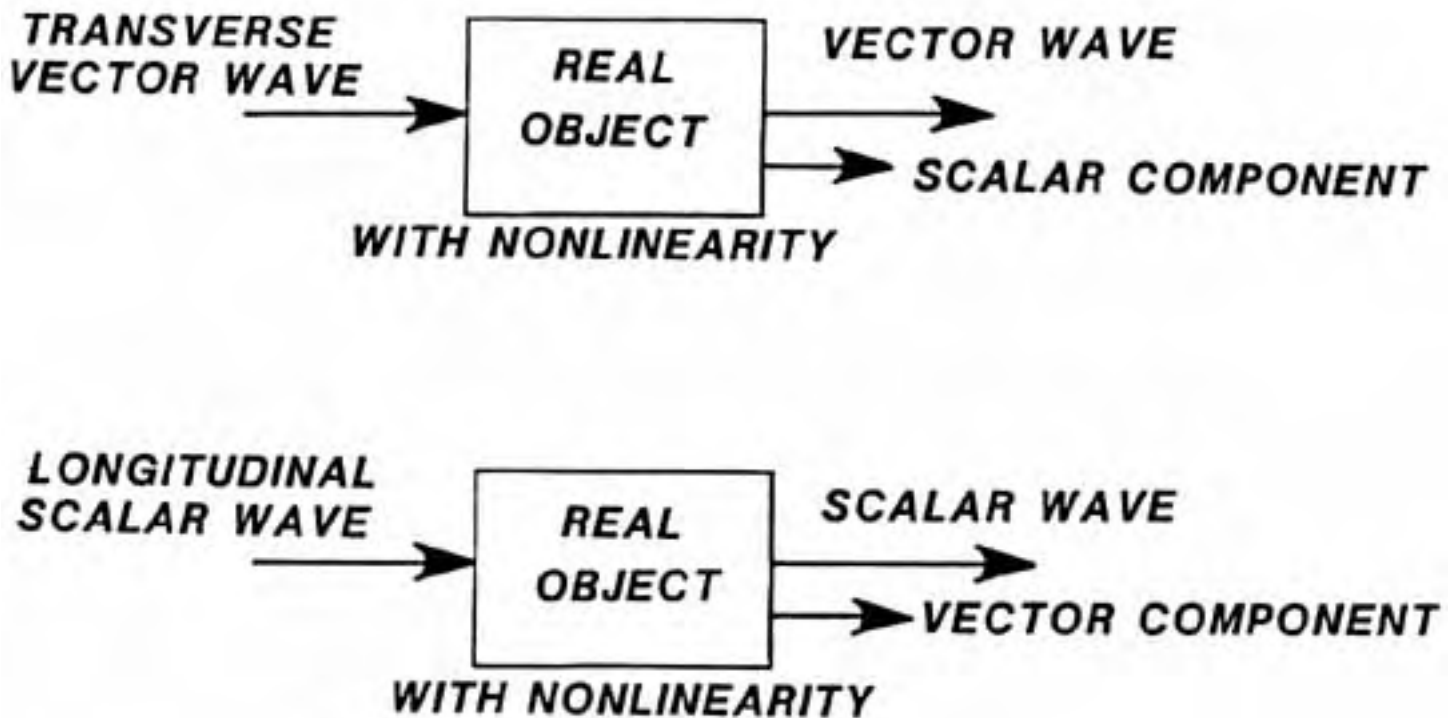

Here we show the results of electrical nonlinearities in an object which encounters a true translated (non-hooking) scalar wave. All objects have some electrical nonlinearities in them, and so all act partially as translators.

This means that any real object creates a small scalar aura around itself from its continual temperature interactions -- from absorbing and radiating ordinary EM waves. In addition, the object normally is subject to undetected scalar wave radiations, and so it also produces a small aura of transverse vector waves around itself by translation.

All real objects accomplish at least a little bit of translation.



[Next Slide](#)

**TOWARDS A NEW ELECTROMAGNETICS**  
**PART 4: VECTORS AND MECHANISMS CLARIFIED**

SLIDE 46.

**THE SCALAR AURA**

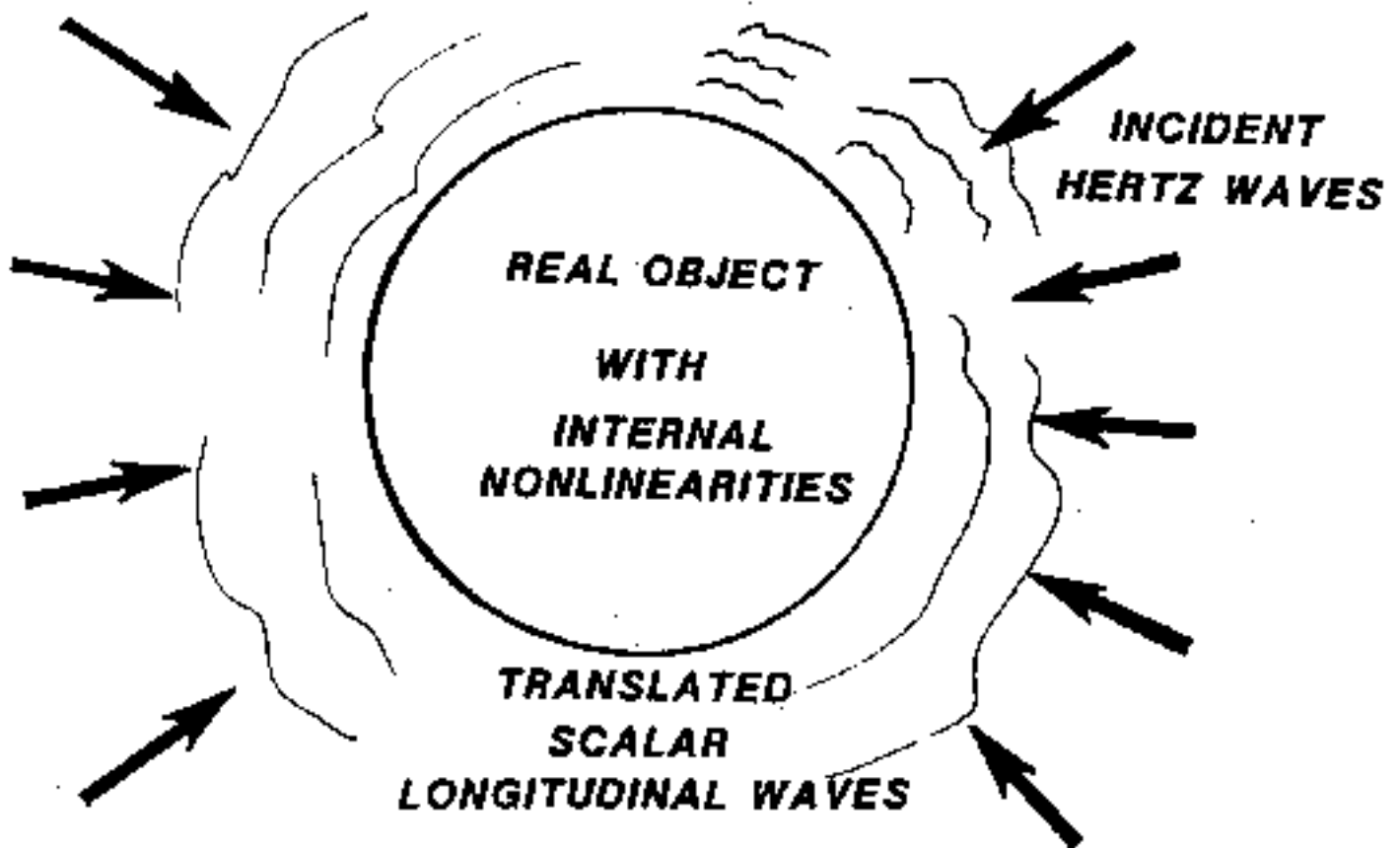

We examine now an object with temperature, that is, a normal object continually absorbing ordinary EM radiation and continually emitting EM radiation.

The object has a small fraction of its incident energy expressed as a scalar aura around it, because of translation. Note that normal detectors will not detect this aura, but special two-stage interferometric detectors will detect it. Also note that the object replenishes- the ordinary radiation flow by its translation of some of its incident scalar radiation into the normal or "transverse" (so-called) radiation.

The entire internal pattern -- all interactions and functions of the body -- are precisely present in its scalar aura, down to the finest detail. This makes an x-ray pale by comparison.

True psychics actually use the nonlinearity of their nervous systems (note the avalanche ion discharges across dendrite gaps) and the interferometric aspects (note two cerebral hemispheres, connected by a corpus callosum) to detect the scalar aura. This is a physical fact and not esoteric delusion. To control this, however, is normally as difficult as learning to walk a high wire and do acrobatics on it. There are not many high wire walkers in the world, but it certainly is a skill within human control capability and purview.

[T. Galen Hieronymus](#) was absolutely correct when he stated that the entire internal working pattern of an object is radiated by that object in terms of an extraordinary energy, which he called "eloptic" energy. It is actually translated scalar wave energy, and entirely consistent with present EM theory when the glaring errors in its foundations are corrected.

Shortly I hope we will see instrumentation which can directly examine the scalar aura in the finest detail, seeing every illness, and simply setting dials to radiate the body with gentle, harmless scalar waves to directly correct illnesses.

[Next Slide](#)

SLIDE 47.

## VIRTUAL FLUX AND MAGNETIC FIELD [LINEAR CASE]

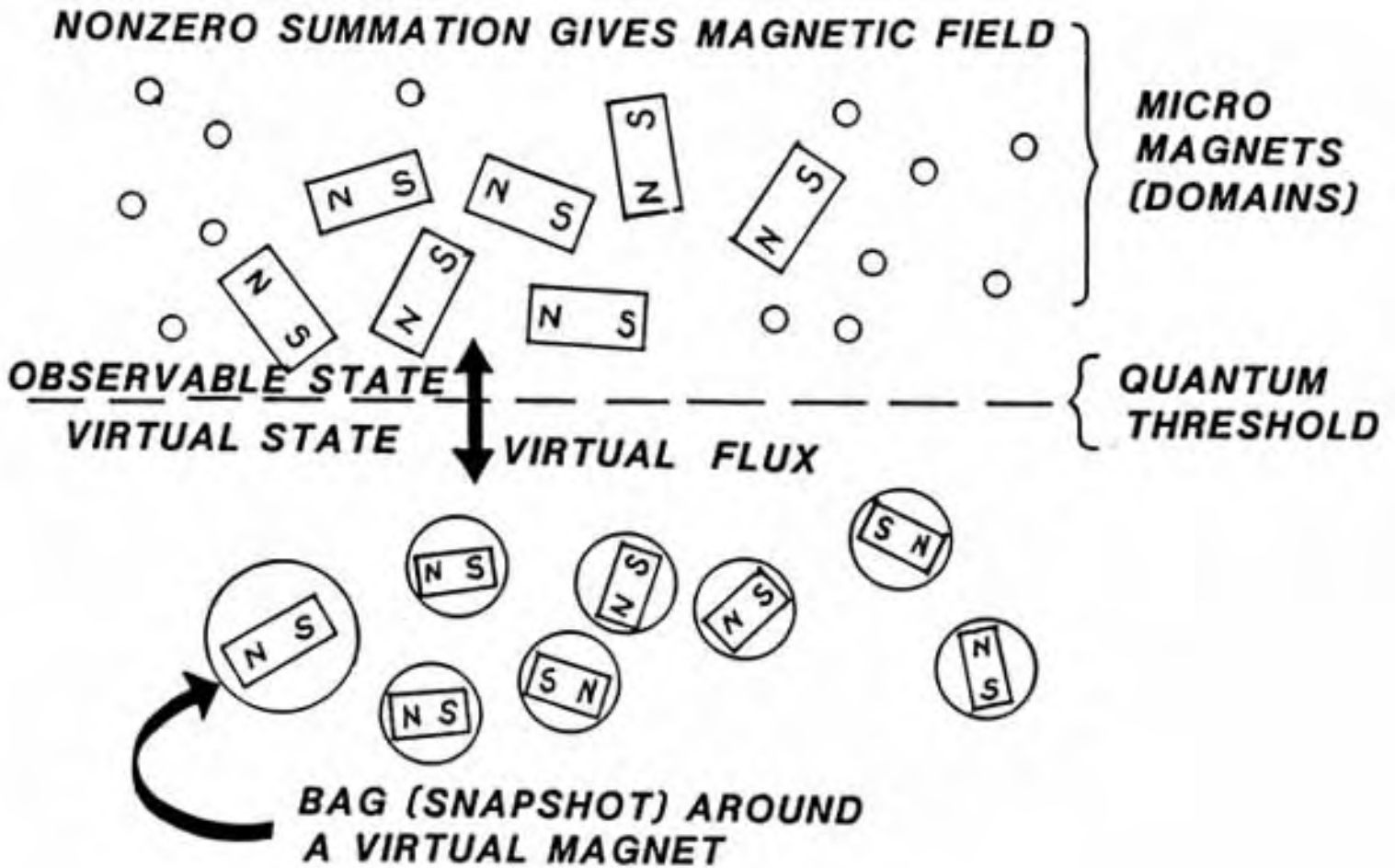

Briefly, let's look at some nice things we can do with magnetism. Specifically, let's find out how to make magnetic monopoles and use them to do things in the laboratory. This again has been done in a laboratory on the North American continent.

First, about all the present science can tell us about a magnet is that "a big magnet is made of littler magnets." And if we examine one of the smaller magnets, it's made of even smaller magnets. This is like saying big dirt piles are made of smaller dirt piles, and that explains what dirt is.

However, let's use that with our knowledge of the virtual flux vacuum.

In this slide, we show diagrammatically the situation for a common magnet. Note that domains in the magnetic material are themselves little magnets, and their alignment and vector summation determine whether or not there's said to be a magnetic field present. Nonzero summation states that there's a resultant magnetic vector, and hence an external magnetic field. Zero summation states there's no external nonzero resultant, hence no external magnetic field.

Actually, there's an external scalar magnetic potential field, even when the external vector magnetic field is zero. The substructure is still there.

If we pursue this "big magnets are composed of smaller magnets," eventually we reach the quantum threshold, and we have a substructure of virtual, subquantal magnets in vacuum, in the virtual particle flux. At least we conceive each little virtual particle as if it were spinning, and hence a little magnet.

We put a conceptual bag around each little virtual magnet.

In a linear situation, the north pole is as strong as the south pole, and so just outside the bag, the poles cancel or appear zero. Since the virtual bag appears to be zero length to an external macro observer, the poles seem to be directly superposed on top of each other, yielding no pole at all to the observer.

However, you and I now know that both poles are still in there, in the virtual substructure, and we certainly have remaining with us a translated scalar magnetic field.

There's a virtual flux to and from each observable particle of charged mass in the observable state as shown, but this flux is now scalar in virtual magnets, except for nonlinearities in the structures

above the quantum level. Thus accelerated portions -- atoms with electrons in whirling orbit, spinning electrons, protons, etc. -- possess nonzero ordinary vector magnetic fields by translation. Again, notice the successive interlocking levels of reality, all the way from deep in the virtual state into interlocking levels in observable state.

[Next Slide](#)

## PRODUCING MAGNETIC MONOPOLES

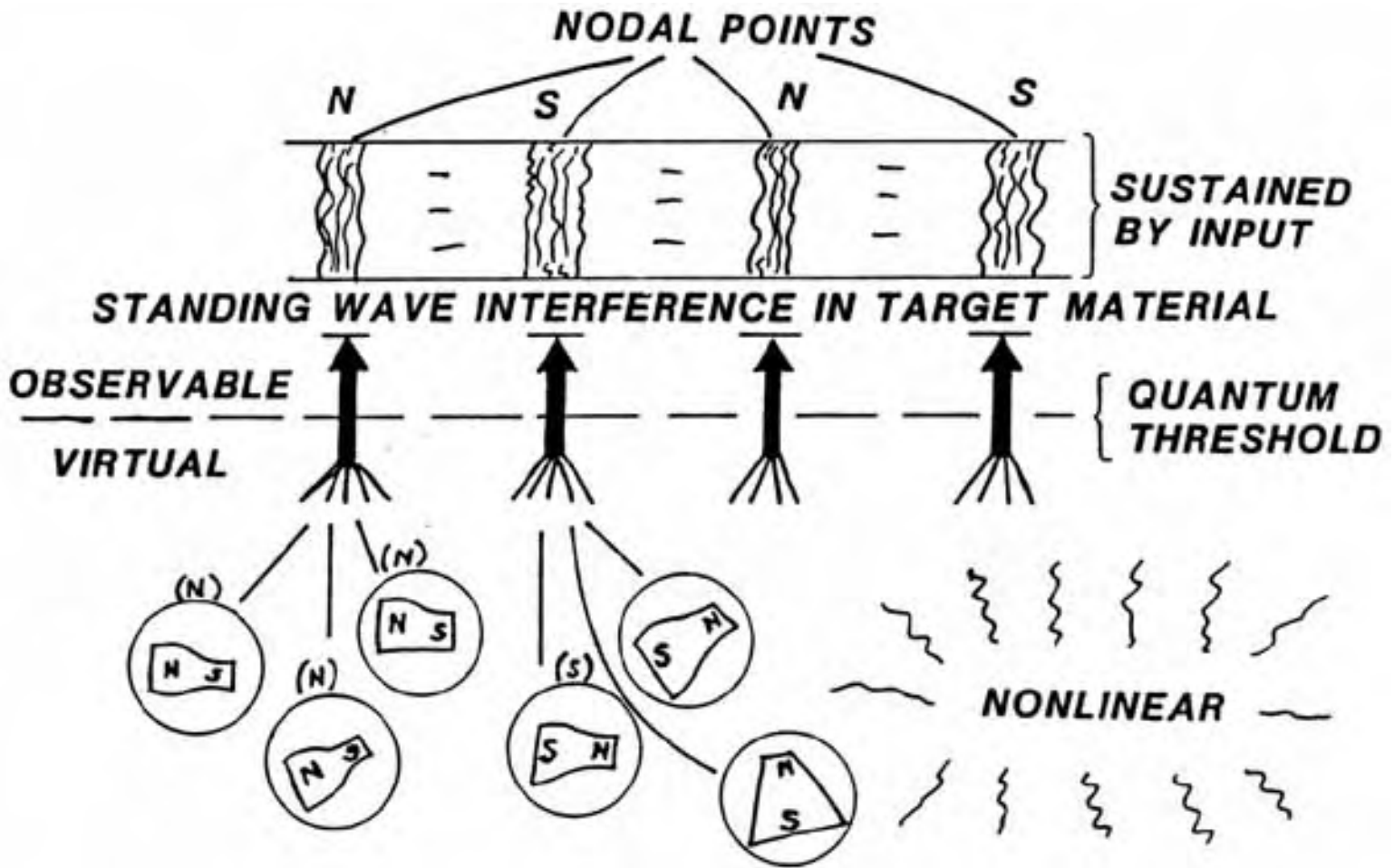

Now let us look at a non-linear case of the same sort of thing. Now the bags are still around the little virtual magnets, but they are nonlinear. This means that, to an observer outside the bag, one pole seems bigger or more powerful than the other. In other words, to the quantum observer, this bag appears to be a magnetic monopole at a point.

In the flux still on and off each observable spinning charged mass, we now have a steady component of "monopoles". If we have a standing scalar wave present in a physical material in which the nonlinearity exists -- and the scalar waves can even be PRODUCING that nonlinearity -- we will have nodes

available at which the monopoles will congregate and emerge and interact.

North monopoles will congregate at one node, while south monopoles will congregate at the next, and so on in alternating fashion.

That means that, at anyone node, monopoles of the same kind are steadily being "deposited" in the material. These monopoles strongly repel each other, and so the material at that node is increasingly stressed in a tensile fashion.

Eventually the material will be torn apart at the node, stress relieving the situation. Movement of the material will release the nonlinear condition, stopping monopole production and deposit. However, at a break node, the same kind of magnetic pole will appear on each side of the break.

That is, the breaks will be N-N, S-S, N-N, S-S, etc.

An ordinary magnetic does not do that when it breaks. Instead, it breaks N-S, N-S, etc.

[Next Slide](#)



## BREAKING METAL WITH MAGNETIC MONOPOLES

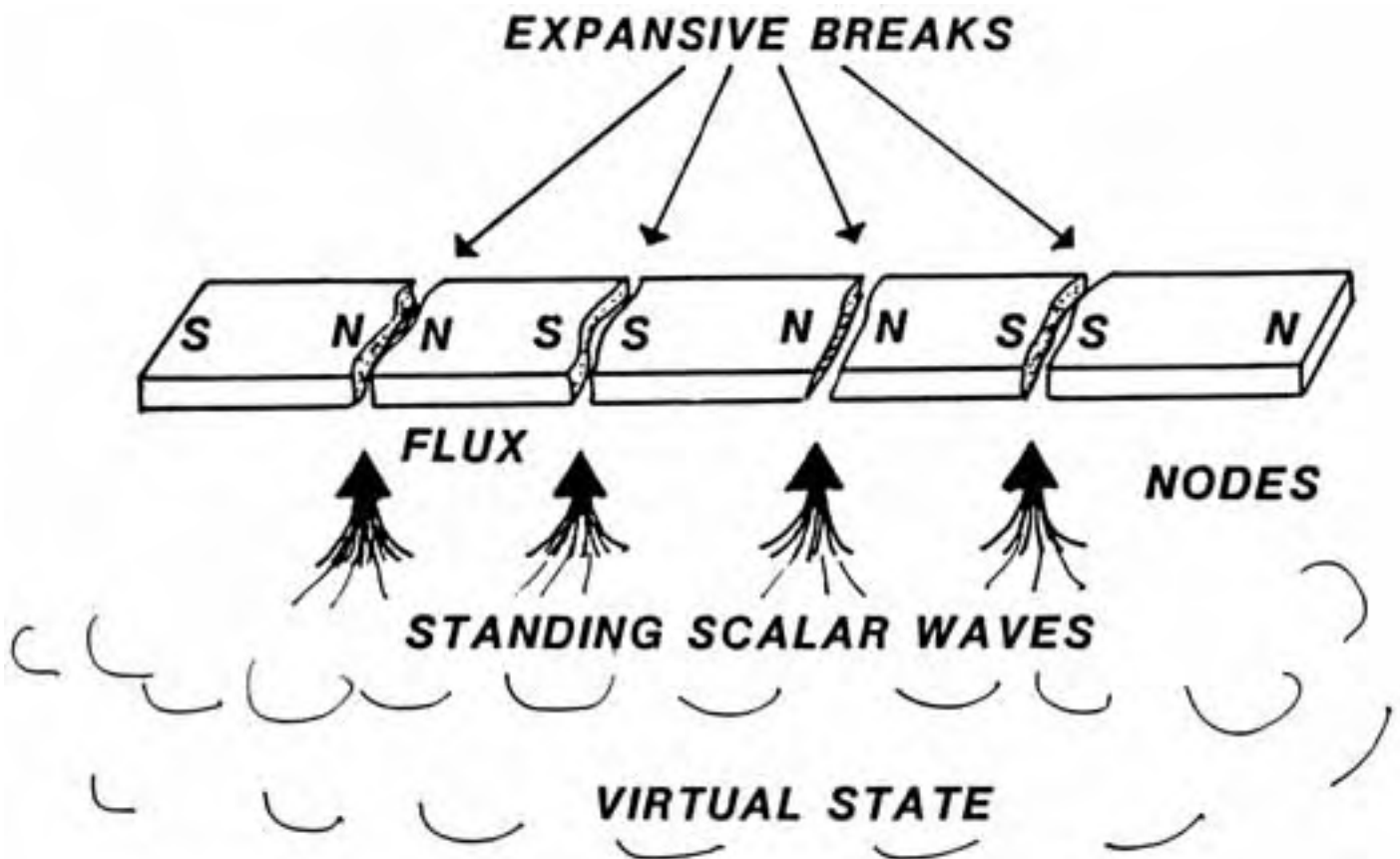

Again, metal has been broken in a North American laboratory utilizing the production and deposit of magnetic monopoles in this fashion.

On this slide we show what was done.

An ordinary bar of steel was exposed to standing scalar waves in a nonlinear situation, depositing magnetic monopoles at the wave nodal points in the metal bar. The breaks occurred as shown on this slide.

Much of what I am presenting is based on certain experiments accomplished in experimental laboratories here and abroad. Most of the mechanisms have actually been produced in the lab. However, these are proprietary labs and I cannot violate trust and

reveal the precise construction details utilized. In some cases I have not seen the precise constructions, but only the direct results.

But ironically, the production of magnetic monopoles -- which has fiercely resisted the normal scientific approach -- yields readily to the new approach.

[Next Slide](#)

[The Tom Bearden Website](#)

SLIDE 50.

## CREATING AN INERTIAL FIELD (ANTIGRAVITY)

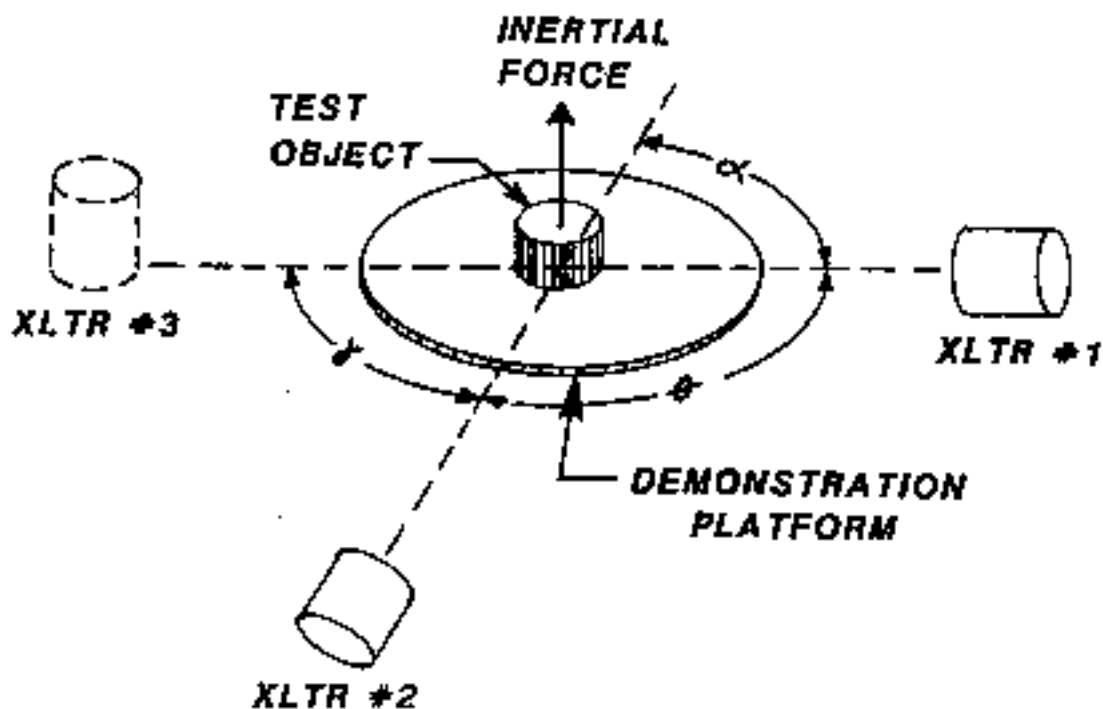

We now show schematically how to produce an inertial field, or antigravity. Also an inertial space drive can be produced in this manner.

This again has been done in a North American laboratory. In fact, inertial fields have been produced in more than one lab here in North America.

In the setup shown here, three translator/transmitter projectors are used and oriented so as to give three-dimensional interference, or interference along all three spatial axes.

By controlling the substructures of the three projectors all together, one can control the precise phasing in all substructures, with respect to a common time reference.

By this means, a unilateral force can be created of each and every charged mass particle (that is, on each proton) in the nucleus.

Since we know that the neutrons and protons in a nucleus of an atom are continually interchanging, one into the other, back and forth, all of the nucleons can be treated as "diffuse protons" for mass purposes, and scalar wave interaction purposes.

Thus if we have the correct pattern to affect protons, we can control the phases of the substructure waves of the projectors so as to produce unilateral, parallel forces on and of each spinning proton in the nucleus.

This means we can produce unilateral thrust in an object exposed to the triad interference of the projectors.

In short, this produces antigravity. If sufficient force is produced, the test object in the interference zone simply lifts itself off against earth gravity. This has been done in North America.

If we phase the projectors so that counterbalancing forces are produced on each proton, we can either make the proton "lighter" inertially or "heavier."

In fact, [we could "freeze" a common pistol](#) so that it could not be moved and its trigger could not be pulled, simply by sufficiently increasing its inertia. [This was done in experimental demonstrations in Toronto, Canada in 1969](#), and witnessed by the [Chief of the Homicide Squad of the Toronto police](#). It was [his](#) pistol that was frozen for the demonstration.

If the projectors themselves are on board a space capsule, for example, they can produce such a unilateral thrust in and of a central mass or disc attached to the of the craft. By this means, an inertial spacedrive can be built.

[Next Slide](#)

## EFFECTS ON HUMANS

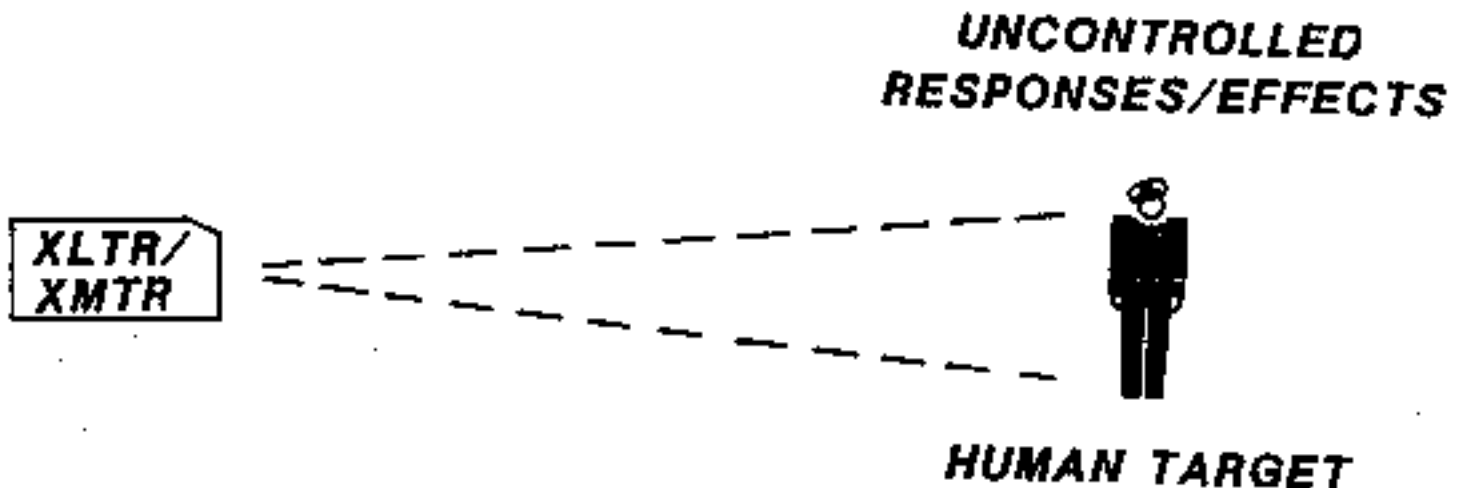

Now let us look at some of the effects on humans, when radiated with a true scalar wave beam from a translator/transmitter.

First, the human nervous system is highly nonlinear. Essentially, across billions of synapses, sudden ion discharges -- analogous to spark discharges -- are continually or periodically occurring. Brain waves, for example, are not waves along wires; instead, they are waves of avalanche discharges across tremendous numbers of nerve cell gaps.

The central nervous system is thus highly nonlinear, and the gap firings of the nerve endings act as translators.

These translators partially translate incident scalar waves, so that additional transverse matter waves -- or ordinary energy inputs -- occur in the ion discharges.

Thus additional energy is being added to the nervous system by incident scalar waves.

Many long-term effects of the environment on the body are gradually kindled in this fashion, even

over a period of years.

For a stronger dosage of scalar waves, the nervous system experiences "jamming" of its signals. This leads to four basic "noise jamming" effects.

If a small dose is absorbed, the interference is slight. One feels as if one had taken a whiff of anaesthesia -- an unreal, dreamy feeling.

If a slightly larger dose is absorbed, the interference is moderate. Now the single channel system -- the motor system -- goes, and the individual is paralyzed. Mentally he is barely conscious, in a sort of hypnagogic, waking dream state. Any tendency toward epileptic seizure or other nervous disorder may surface here, as may heart palpitations or even heart failure.

For a heavier dosage yet, the interference is now strong. Now the multiple systems start failing. Consciousness is lost and the individual is in a deep coma. In addition, seizures and convulsions, and loss of control of some body functions, may occur. The autonomic nervous system is keeping the heart beating with difficulty and keeping the body gasping for breath.

For a very strong dosage, the entire nervous system fails and death results almost immediately. This is quite similar to the effects of nerve gas.

These are the four major symptoms of scalar wave radiation of the body and translating absorption by the nervous system in an uncoordinated fashion.

[Next Slide](#)

[The Tom Bearden Website](#)

**TOWARDS A NEW ELECTROMAGNETICS  
PART 4: VECTORS AND MECHANISMS CLARIFIED**

SLIDE 52.

**INITIATING SPECIFIC BIOLOGICAL EFFECTS**

**NOTE:**

- **PAVLITA'S 64 POINTS**
- **ADAMENKO'S PLEXUSES**

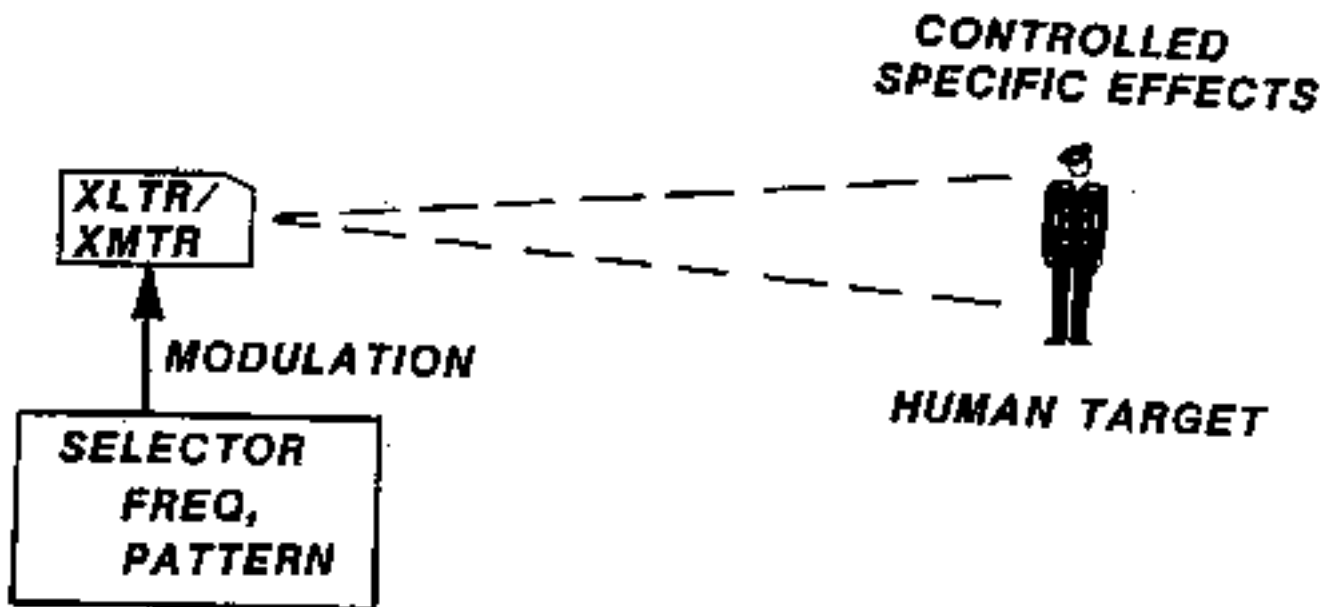

If we now add precisely patterned modulations to the substructure waves of the scalar zero vector beam, we can induce deliberate patterns in the dosage absorbed by a biological system.

As [Kaznachejev's experiments](#) showed, any death or disease pattern can be induced upon an electromagnetic carrier -- specifically, upon the near-ultraviolet as an example. Some of his experiments were duplicated at the University of Marburg in West Germany, utilizing infrared carriers. These patterns can be dumped into cell cultures, eventually kindling the pattern of death or disease in the target cells.

The same can be done to a human from an external source. The major entry point is the acupuncture system, which reacts to scalar waves and transfers them to the nervous system for translation.

Pavlita, Czechoslovakian engineer, has built "psychotronic generators" for over 30 years that affect the human body. Adamenko, Soviet physicist, found that the acupuncture points formed groupings or plexuses that were frequency sensitive. In other words, certain frequency bands affect one plexus more than others. Further, these acupuncture points are known to be connected to effects produced at remote locations in the body.

Pavlita stated he had found 64 different sensitive "points" on the body, and had succeeded in building a generator for each. If by his points he meant Adamenko's plexuses, then frequency patterns can be created that affect certain acupuncture groupings -- and thereby certain specific body locations and effects -- more than others.

It thus appears reasonable that, by placing the proper frequency pattern in the modulations of the substructure waves feeding into the translator/transmitter, the scalar ray or beam can be made highly selective as to body part affected and the effect generated or kindled in the body.

By this means, specifically tailored attacks on the body can be created.

Strong emotions such as sheer terror, overpowering rage, blind panic, etc. can be induced. Or physical effects such as epileptic seizure, loss of control of internal functions, loss of muscular control, severe weakness, specific failure of an individual organ such as the heart or liver, or blackouts and comas can be induced. In addition, patterns for specific toxins and diseases can be induced. With a strong absorption, these changes can be effected quickly. Imagine bubonic plague developing in 30 seconds, for example, or the effects of a cobra bite developing in 10 seconds.

If the individual is placed in crossed interference beams (that is, in the interference zone of a scalar interferometer), strong effects can be produced essentially instantly, including instantaneous death.

Of course BENEFICIAL effects can also be accomplished. As instrumentation is developed, one should be able to scan the aura, do a computerized



readout to show the different medical problems either developed or developing in the body, have the computer compose a "cancellation or offsetting pattern," and radiate the body with a totally beneficial pattern, customized for that particular condition at that particular time. One should be able to quickly cure cancers and leukemias, for example, even of the brain and of the bone marrow. One may even be able to quickly reverse the effects of aging; at least there is no foreseeable reason why it should not be possible.

The new technology is a very powerful tool, and it can be used for either good or bad, depending upon the intent of the developer and the user.

[Next Slide](#)

[The Tom Bearden Website](#)

SLIDE 53.

## GROUND-TO-AIR USE

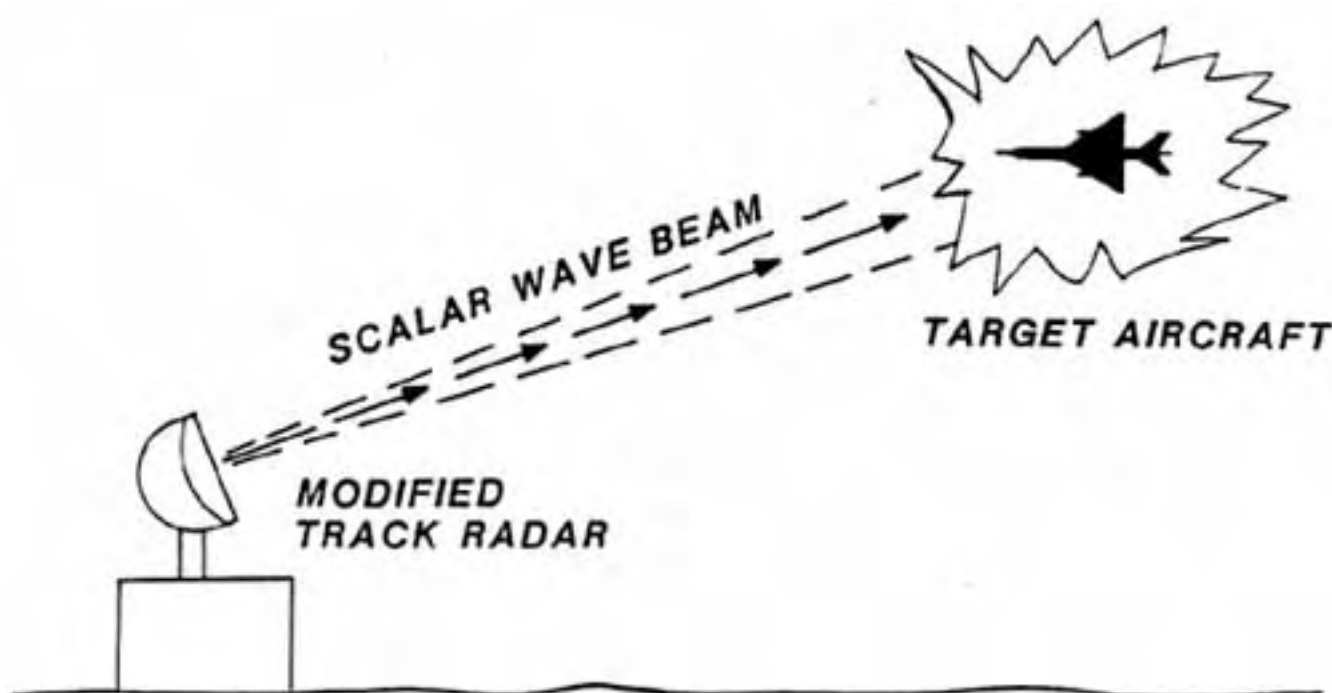

Here we show another use of the scalar beam technology already developed by foreign powers.

A modified track radar -- either continuous wave or pulsed -- transmits a scalar wave beam. It radiates an incoming hostile aircraft, keeping the beam on it, and kindling energy in the nonlinear electronic circuits of the aircraft by translation. Communications, navigation systems, avionics systems, electronic fuze systems, ignition and control systems, airborne radar, missile armament electronics, etc. are all vulnerable to this translation kindling of internally jamming energy from the incident scalar beam.

The electronics can be knocked out and the aircraft knocked down.

The pilot himself is also vulnerable because of his highly nonlinear central nervous system.

Some or all of the eight F-111's mysteriously

lost in  
Vietnam may have been bagged by modified SA-2  
FANSONG radars, using this effect.

[Next Slide](#)

## [The Tom Bearden Website](#)

SLIDE 54.

### TACTICAL AIR-TO-GROUND USAGE

---

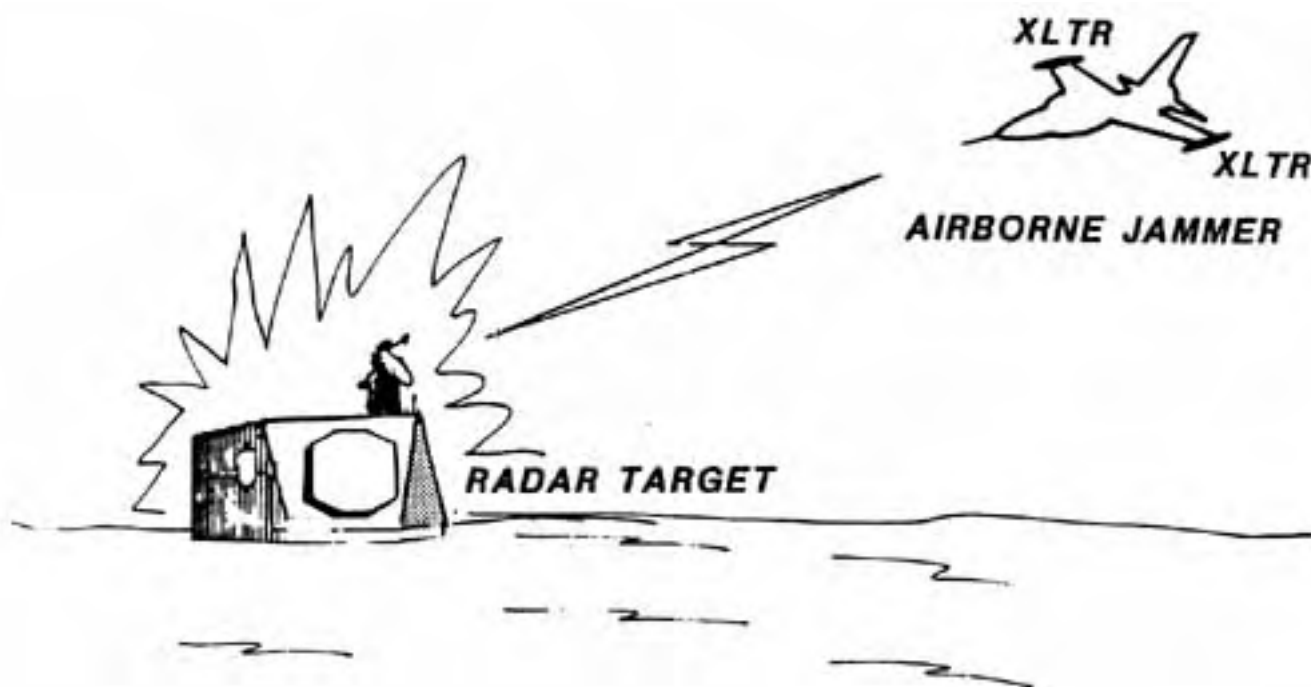

As shown on this slide, the technology is also usable from aircraft against ground targets, particularly ground-based radars and communications systems.

As shown, the aircraft has a modified jammer, able to emit a beam of scalar energy from one or more translator/transmitters.

By simply training a beam on the radar, eventually the radar can be knocked out. That is the simplest use.

A more sophisticated usage is provided by more than one translator/transmitter, acting as a scalar interferometer.

In this mode, each translator/transmitter emits multiple scalar carrier frequencies. Two Fourier expansions are established, so that a three dimensional "ball" or sphere of interference-zone energy is established. By pulsing or phasing, this ball is moved to strike the location of the radar, delivering a large burst of energy to it and knocking it out. Alternatively,

the energy bottle is "dumped" when it reaches the targeted radar or its near vicinity.

A still better way is to fire one Fourier scalar pattern directly at the target radar, then fire a second pulse faster so that it overtakes the first directly upon the target. (The ensemble of such a pattern acts as a soliton, and its velocity is controllable by controlling the amplitude of the pattern generated).

When the second scalar overtakes the first, a sharp interference is formed, with a fast energy bottle, which is then nonlinearly dumped in microseconds or milliseconds. In this fashion, all the energy put out by the jammer is delivered directly upon and into the target in one sharp EMP pulse, much like that from a small nuclear explosion. The target is destroyed.

Note that such a weapon can be utilized against tanks, vehicles, explosives, missiles, ammunition, bridges (the airblast), bunkers (the blast can occur INSIDE the enclosure), ships, planes, personnel, and targets of varied types.

The Soviets have had such secret weapons for years.

One additional country has them also.

[Next Slide](#)

# [The Tom Bearden Website](#)

SLIDE 55.

## INTEGRATED WEAPONS DISPLAY (MODIFIED JAMMER)

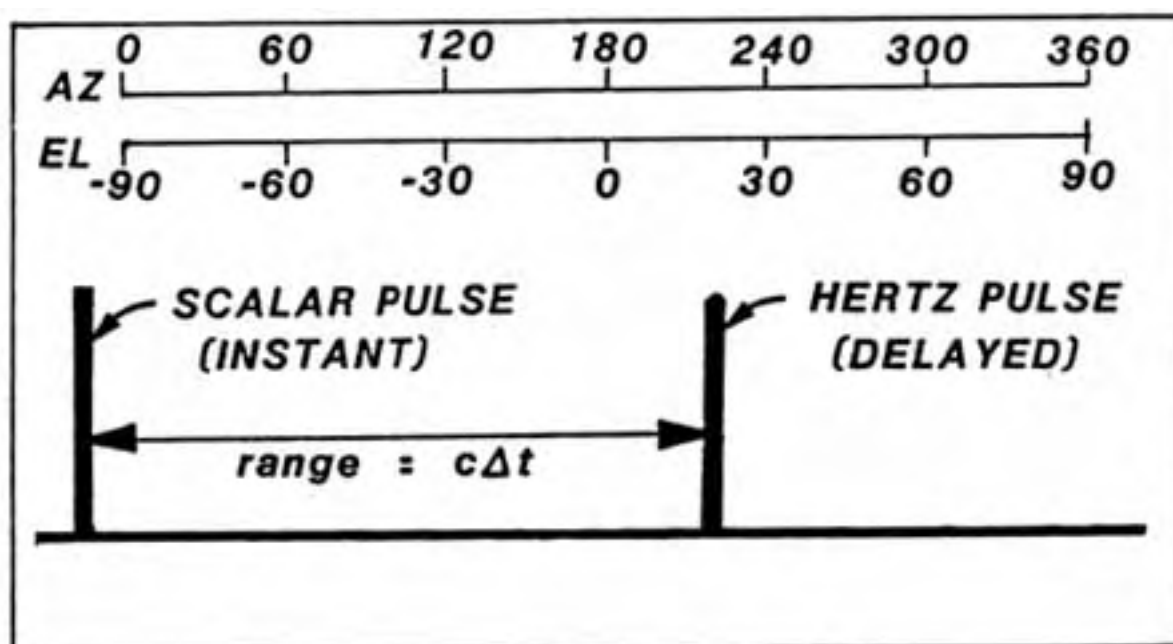

Here we show diagrammatically what a modified Soviet integrated weapons display for a modified jammer might be, to employ scalar interferometer weaponry.

As the "main bang" is emerging from the antenna of the target radar on the ground, the phi-field from it reaches to infinity, including through the aircraft with a finite magnitude. In the aircraft, two channels act in interferometer fashion as a scalar detector for phi-dot. The main bang creation (phi-dot) is detected, and displayed as the leftmost pulse.

At that time, a computer time-base starts clocking off microseconds.

At some time later, the third channel, acting as a normal receiver, receives the ordinary "Hertz" pulse from the radar, which has traveled to the aircraft at the

speed of light.

The computer converts elapsed time between the scalar pulse and the Hertz pulse to range.

Azimuth and elevation angle to the radar are obtained by normal angle tracking.

At this time, the computer has the exact coordinates of the radar, allowing for motion of the aircraft during the lapse time.

The computer switches the interferometer into transmit mode, and arranges amplitude patterns to target the radar.

It fires the first scalar pulse, then fires the second so as to create the full EMP directly upon the target.

The EMP flash occurs, destroying the radar.

At that time, another target can be processed.

In a more advanced weapon, scanning may be used to detect, locate, target, and engage multiple targets, including incoming air-to-air and surface-to-air missiles, one after another.

The same weapon is usable against a variety of aerial and ground based targets.

The major weapon is the electronic emitter, not a missile or ordinary ordnance.

Hordes of such special "jammer aircraft" now become a potent force on the battlefield, destroying all before them with annihilating ray weapons.

Star war is a reality now.

The High Frontier is already seriously obsolete.

Our entire defense establishment is completely vulnerable to these weapons at present, for we have not developed countermeasures or defenses.

[Next Slide](#)

[The Tom Bearden Website](#)

**TOWARDS A NEW ELECTROMAGNETICS  
PART 4: VECTORS AND MECHANISMS CLARIFIED**

SLIDE 56

**RADAR INVISIBILITY**

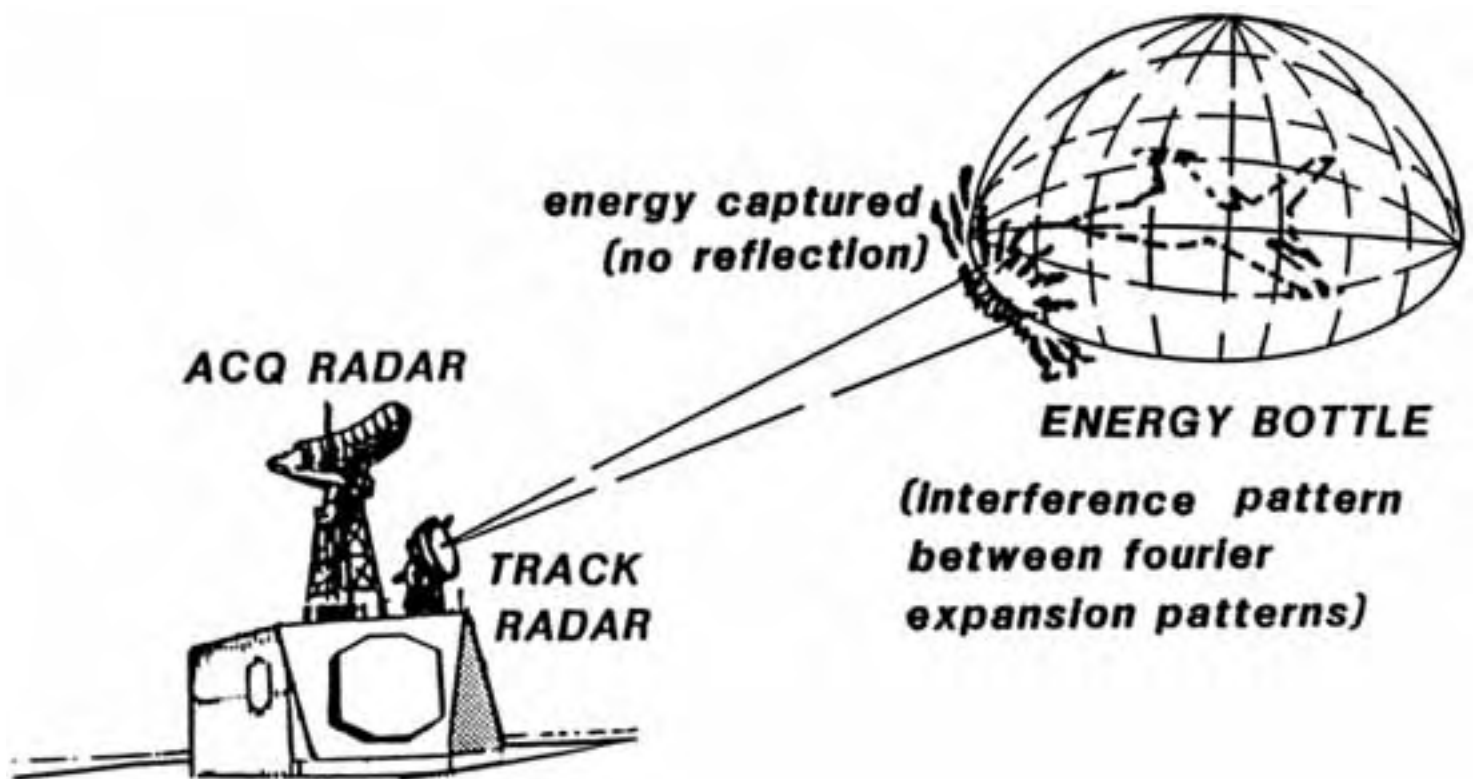

On this slide we show another effect which can be obtained. We can make an airplane invisible to ordinary radar.

Imagine now the same "jammer" type aircraft with three channels, one for use in scalar interferometry and one as an ordinary channel.

This time, a [Fourier interference pattern](#) is established around the aircraft, so this establishes an "energy bottle" around the plane. We specifically arrange this bottle in the frequency band of the hostile radar we wish to avoid. For multiple bands, we establish multiple bottles -- this just requires more



frequencies or more translator/transmitters.

The beam from the ground radar now strikes the energy bottle, and its energy enters and is trapped in the bottle grids. Since the bottle is leaky, the incident energy gradually disperses and "leaks" out all around, with very little emerging energy.

The ground radar receives no return pulse or reflection.

Therefore it sees no target.

The same interferometer system is usable both in this defensive screen fashion and in the attack fashion previously discussed.

Use of this system has been demonstrated internationally.

An energy bottle has been created in a North American laboratory as well.

[Next Slide](#)

[The Tom Bearden Website](#)

SLIDE 57.

## NETWORK OF VIRTUAL TRANSMITTERS

---

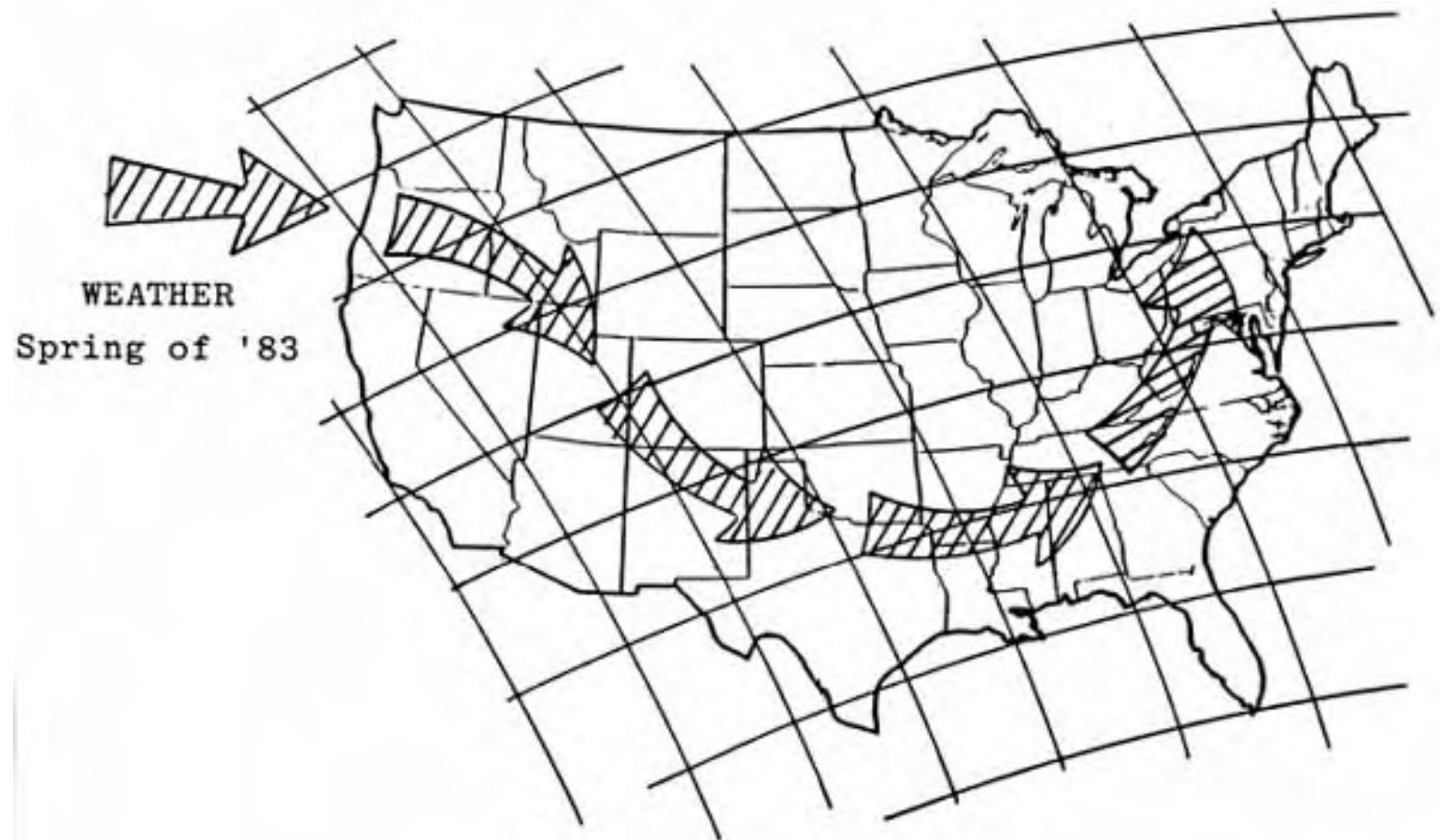

As is well-known, for years the Soviets have blanketed the world with large, powerful transmitter signals in the communications band, referred to as the "Woodpecker" signals because of the staccato noise the chirped signals make to the ear. The carriers have been modulated with known harmful bioactive ELF frequencies. At least some effects have been noted on humans from these signals, and other human effects are suspected but not proven.

In addition, evidence exists that such transmitters, utilized in the scalar transmission mode, may have been used to cause earthquakes and to control the weather. High altitude bursts off the coast of the Eastern United States and Canada, over

Timmons, Ontario, Canada, and off the coast from St. Petersburg, Florida have occurred also.

Mysterious "blackouts" of U. S .satellites -- and British satellites -- have occurred. These would be difficult to explain as the result of illumination from a ground laser, but easily explained as the result of illumination from a ground-based scalar beam or scalar interferometer.

Strange patterns of micro sky quakes and micro earthquakes occurred at various locations throughout the U.S. just before and shortly after the death of Leonid Brezhnev. These strongly appear to be connected with the adjustment of a scalar interference pattern -- a gigantic "energy bottle" across North America, as shown on this slide.

Shortly after this suspected adjustment and alignment, the underground net in the U.S. detected the emergence of numerous ELF-modulated signal carriers throughout the U.S., generally utilizing carriers in the vicinity of 40 MHz. Locations of the apparent transmitters were such places as Atlanta, North Georgia, St. Petersburg, Florida; Mississippi; Alabama; in the vicinity of Washington, D.C.; near Boston; around the Great Lakes; Michigan; in the Pacific Northwest (Washington and Oregon); and in both northern and southern California.

Researchers knowledgeable of the Soviet woodpecker signals and ELF modulations detected and reported these signals.

Physical effects were reported and correlated to the signals, including wakefulness at night, restlessness, fatigue, headaches, nausea, ringing in the ears, anxiety, disturbed dreams, etc.

What appears to have occurred is the adjustment and alignment of a vast scalar interference pattern across the U.S. Recall that energy emerges in each grid, by phase interference between the composite substructure waves of the scalar beams.

Thus the Woodpecker "over-the-horizon radars," as accepted by Western intelligence analysts, may have acquired a diabolical new strategic capability.

It is as if the Soviets had been permitted to build a vast network of transmitters directly on U.S. soil, for hostile employment against U.S. citizens.

Shortly after the net was aligned, a curious pattern of weather assaults on the U.S. began.

Storms assaulted California unceasingly. Then they roared across the Rockies, dipping sharply down to hit the Texas Panhandle, and bending northeast again to assault the South and the East.

The mighty jetstreams themselves were diverted and "kinked" into this looped, distorted pattern.

And the storms and floods assaulted the U.S. one after the other in this highly unusual fashion.

I maintain that the virtual transmitter net, just established by the Soviets and adjusted in on the U.S., was tested in the weather control mode. If so, it proved highly effective. Imagine what would have happened to the U.S. if it had been unleashed full force, and not just "gently tested."

And imagine what happens when disease, death, and nervous system disturbances are modulated upon these blanketing signals. The "transmitters" for the patterns are in each grid, all across the U.S.! And there are no physical transmitters there to destroy.

A counter is needed quickly. A simple one would consist of recording the signals in each grid zone, analyzing the substructure, reversing the signals and their structured patterns 180 degrees, and feeding the "cancellation signals" out in each area.

A great strategic Russian weapon of devastating power and potential is now operating directly on U.S. soil. The need for a crash countermeasures program is urgent.

In 1975 Brezhnev had introduced to the SALT talks the strange proposal that we should also consider outlawing the development of new weapons more frightful than the mind of man had ever imagined. We didn't know what the Russians were talking about. When we asked them later what weapons they meant, they referred vaguely to weapons of an electromagnetic nature.

The presentation I have just given you is part of what Brezhnev meant.

[Next Slide](#)

[The Tom Bearden  
Website](#)

SLIDE 58.

## CONCLUSION

---



In conclusion, today I have released a number of powerful mechanisms that result from the new technological concepts. Many of these were originally discovered -- at least in rudimentary form -- by Nikola Tesla. In the West, the suppression of Tesla led to the suppression of these effects. And our knowledge of them went to the grave with Tesla.

After World War II, the Soviet Union mounted a massive campaign to obtain all the scientific literature of the West and thoroughly digest it. Great centers were set up, and thousands

of PhD's devoted to this purpose. Gradually they synthesized this technology from the errors in EM foundations they uncovered, and from obscure, ignored papers published in the orthodox Western scientific literature.

They rediscovered the technology of Tesla, Moray, and Rogers. And they have highly weaponized the effects, and adjusted and aligned the weapons upon us.

Now the radical movements are onto part of this technology. As late as about six months ago, one such group discovered how to build a translator and a scalar beam projector. Excitedly, they planned to build them the size of a large pistol, powered by a portable battery pack, and sell them to street criminals to kill or stop the police. They planned to get rich by this illicit means. At that time, a personal friend of mine, who moves in underground circles, was attempting to purchase one of the prototypes for my analysis. Fortunately, the inventor stepped into the beam of one of his devices and was almost killed. This frightened the group, and at least for now they have desisted. But be forewarned: this technology is coming down the pipe, and the police establishments in the West are in for the shock of their lives if the scientific community does not wake up and prepare defenses.

Again I urge my fellow colleagues to experiment vigorously with these new concepts, but build equipment for the benefit of man. Insect control, disease elimination and control -- both are noble purposes. Defense against the hostile use of such devices is also a fitting purpose.

We are in the final days, and the final technology is upon us. It is a stupendous tool for either good or bad, and assuredly it will be utilized for both means. I call attention once again to the fact that my ultimate purpose is to use this technology benevolently to achieve mind linkage, and elevate man from his present brutish state to the lofty state that is his destiny and his true God-nature.

For better or worse, Tesla technology is once again loose in the world, this time for good, and on a massive scale.

Let us prepare ourselves for a wild canoe ride, for the real white water lies just ahead.

Thank you for your attention, and good evening.