

The interaction of mind and matter!

## EXCALIBUR BRIEFING



UFO phenomena are just one aspect of the interrelationship of humans with their collective species. In this extraordinary book, Lieutenant Colonel Thomas E. Bearden, PhD (U.S. Army, Retired) deals with many of the subjects of which he has been active as a conceptualist: scalar electromagnetics and electrogravitation, Soviet psychotronic (Tesla) weaponry, free energy devices, and anomalous phenomena.

UFO sightings are shown to precisely fit predictions for the future, and there is a direct explanation of mind and matter in UFO activity. Colonel Bearden shows us what UFOs are and how they are formed; what the bioenergy is in Hieronymus devices; and he discusses thought photography, psychic surgery, psychokinesis, cattle mutilations, ghost rockets, contactees and space-suited beings, flying saucers and much more.

Previously, Colonel Bearden was senior scientist with a major aero-space company where he directed the company's design and production of expert system (artificial intelligence) applications for the U.S. Army command and control systems. He has had direct experience with tube artillery and with the Ajax, Hercules, Hawk, and Patriot air defense missile systems. He also directed the production of U.S. Army technical intelligence on Soviet surface-to-air missile systems.

A compelling book, not to be missed!

ISBN 0-89407-868-6

Sweating done by red\_gonzo.

Note: sometimes formatting of the text may be a little fuzzy. It's all because the OCR process didn't go as smoothly as I expected. Also there may be some errors inside text so be vigilant. In any case share this book, send emails to people about knowledge contained in it.

*Lieutenant Colonel Thomas E. Bearden (U.S. Army, Retired) Ph.D., was formerly senior scientist and department manager of a major aerospace company where he directed the design and production of expert systems (artificial intelligence) applications for the U.S. Army command and control systems.*

*He has over 29 years of experience in air defence systems, tactics, and operations; technical intelligence; command and control expert systems applications; nuclear weapons employment; computerized wargames; anti-radiation missile countermeasures; and military systems requirements. He has direct experience with tube artillery and with the Ajax, Hercules, Hawk, and Patriot air defense missile systems. He also directed the production of U.S. Army technical intelligence on Soviet surface-to-air missile systems.*

*Colonel Bearden obtained a Master of Science degree in nuclear engineering from the Georgia Institute of Technology, and a Bachelor of Science degree in mathematics from Northeast Louisiana University. He is a graduate of the U.S. Army Command and General Staff College, as well as of several U.S. Army artillery and missile schools.*

*He holds a Sandan (third degree black belt) in Yoseikan aikido and was the first president of the Yoseikan Aikido Association of North America. He is a former singer, guitarist, songwriter, and recording artist. He is member of Mensa, the Society for the Investigation of the Unexplained, the International Tesla Society, the American Association for the Advancement of Science, the Association of the American Physics Teachers, the Air Force Association, the Association of the U.S. Army, the American Nuclear Society, the Association of Old Crows, the American Defense Preparedness Association, and the Alabama Academy of Sciences. He is also East Coast Director for the Association of Distinguished American Scientists.*

*Tom Bearden is the author of several books and numerous papers, briefings and presentations, dealing with anomalous phenomena, scalar electromagnetics, free energy devices, Soviet Tesla weapons, and Soviet scalar electromagnetic weather warfare; he is also the producer of several videotapes on these subjects.*

# Table of Contents

Foreword, by John White . . . . .	xv
Introduction to Second Edition . . . . .	xvii
Introduction to First Edition . . . . .	xxix

## Part One: A Sampling of Specific Paranormal Phenomena

The Vestigia Mystery light Experiment . . . . .	35
Unexplained Generation of Electricity. . . . .	42
Hyperfield Generation of Photon Patterns About A Bar Magnet Collector . . . . .	43
Hyperfield Circulation Patterns Above a Magnetized Railroad Track . . . . .	46
The Cyborg Effect and Orthorotational Sensitivity. . . . .	49
Additional Factors Consistent with the Vestigia Experiment . . . . .	51
Remote Viewing . . . . .	52
The Moray Radiant Energy Device. . . . .	54
An Atlantean Power Crystal? . . . . .	60
The Crystal Skull . . . . .	61
Metal Bending . . . . .	65
Thought Photography: Stella Lansing . . . . .	65
The Displacement Effect . . . . .	68
Pavlitia's Psychotronic Generators. . . . .	71
Cell-like Invisible Tupoidal Forms. . . . .	71
UFOs . . . . .	74
1. BlackRingUFO. . . . .	74
2. AnchorPatterns. . . . .	74
3. Bifringement . . . . .	76
4. UFOs in Water. . . . .	76
5. UFOs in Clouds. . . . .	76
6. UFO Seen by the Author. . . . .	76
7. The 1966 Dennis Billings UFO Sighting . . . . .	82
8. The Second Billings UFO Sighting . . . . .	87
9. The 1973 Pascagoula UFO Sighting . . . . .	88
10. Other UFOs. . . . .	89
Falkville Spaceman . . . . .	89
Men-in-Black . . . . .	94
Sasquatch . . . . .	95
UFOs Over the Soviet Union . . . . .	99
The Sighting Over Petrozavodsk . . . . .	103
French Experiments with Psychotronics. . . . .	104
Dowsing . . . . .	104
The Strobe Effect . . . . .	105
Kirlian Photography. . . . .	111
Interaction of Biofield, Thought and Spark Discharge. . . . .	111

Kervran Effect . . . . .	114
Psychic Surgery. . . . .	114
A Deliberate Experiment with Kindling . . . . .	118
Fay Clark's "Fireflies". . . . .	118
"Foo" Fighters. . . . .	119
Water Monsters. . . . .	119
Cattle Mutilations. . . . .	123
Big Mama . . . . .	123

## **Part Two: A Theoretical Background for Understanding PT, UFOs, and Psi Phenomena**

Some Unexplained Mysteries of Physics. . . . .	129
Uri Geller. . . . .	130
My Approach to Psychotronics. . . . .	131
1. Reality as a Paranormal Bridge with Two Ends. . . . .	133
2. A Fundamental Correction to Classical Logic. . . . .	136
3. A Physical Example. . . . .	139
4. New Definition of Zero. . . . .	140
5. Einstein's Postulate. . . . .	141
6. Synchronicity of Concepts. . . . .	142
Primitive Perception. . . . .	142
Two-Slit Experiment . . . . .	146
Photon Quenching of the Paranormal (Time) Channel. . . . .	151
Raindrop Model of Quantized Change. . . . .	155
Kindling Effect . . . . .	156
Bioenergy Collectors. . . . .	157
Psychometric Effect. . . . .	159
All Mass Is Charged: Everything Is Electrical. . . . .	160
A Funny Thing About Electromagnetic Field. . . . .	163
Extinguishing Electrical Currents. . . . .	165
Death Transmission Via the Paranormal Channel. . . . .	166
Disease and Death Induction. . . . .	169
Dynamic Thought Constructs: Biofield Mechanisms. . . . .	170
Radionics. . . . .	171
Psychotronic Devices: A Simple Space (Quiton) Amplifier. . . . .	172
Typical Hieronymus Device. . . . .	172
Another Kind of Hieronymus Device and the Inceptive Cyborg Effect . . . . .	175
Probability: Throw of a Die. . . . .	176
Negative Time. . . . .	177
Time Oscillation, Quantum Change, and Mass. . . . .	177
Mass Is a Time-Differentiation. . . . .	178
Reality Is Like an Opossum. . . . .	179
Biofield Concepts. . . . .	180
Mass, Force, and 3-D Frame Rotation. . . . .	180

Mass is pi Rotation of Hyperspatial Flux. . . . .	184
Jitter or Dither Modulates the Primary Flux. . . . .	185
The Untold Story of Quarks. . . . .	186
Einstein's Spherical Model of the Cosmos. . . . .	188
A Charged Particle Is a Dual Closure of the Universe. . . . .	188
Adding and Subtracting Dimensions. . . . .	189
Mind Is Objective. . . . .	191
The Skin Transducer Effect: Turning a Thing into Its Opposite. . . . .	193
Everett's Many-Worlds Interpretation of Quantum Mechanics. . . . .	193
Spacetime Curvature Is Tricky. . . . .	193
Multiple Realities (Many Worlds). . . . .	194
Clustered Orthogonal Worlds. . . . .	196
Crosstalk Between Multiple Realities. . . . .	199
Biofields: And Maverick Worlds. . . . .	200
Hyperfield Flux in a Magnetic Field. . . . .	201
Life and Death. . . . .	202
The Holographic Hyperchannel Effect. . . . .	209
Mind Linkage. . . . .	212
Angels, Imps, and UFO Tulpas. . . . .	214
Dreams and Unresolved Conflicts. . . . .	215
Ghost Rockets and Flying Saucers: Materialized Tulpoids. . . . .	218

## Part Three: New Military Applications of Psi Research

Background to Psychotronic Research in the U.S. and the U.S.S.R. . . . .	223
Psychotronic Background Since WWII. . . . .	224
Electron Dissolution. . . . .	225
The 1973 Contactee Wave and Cattle Mutilations. . . . .	226
Radiation of the U.S. Embassy. . . . .	229
Disease and Death Transmission. . . . .	229
Other Weapons. . . . .	230
Hyperspace Howitzer Operation. . . . .	230
A Possible Operational Test of Psychotronic Antiaircraft Weapons. . . . .	236
Population Conditioner. . . . .	238
A Midcourse ABM System. . . . .	241
The Bell Island Incident. . . . .	242
A Terminal ABM System. . . . .	245
Sweep Mode, Sweeping Away a Nuclear Detonation. . . . .	246
Zarg, Armageddon, and Linkage. . . . .	247
Virtual States and Hyperspaces. . . . .	254
Feynman Diagrams. . . . .	256
Nature of an Electromagnetic Wave. . . . .	261
Neutrinic Longitudinal Polarization Waves. . . . .	262
A New Look at Modulation. . . . .	265
Hyperspatial Aspects of Modulation. . . . .	269

The Eureka Concept . . . . .	272
Biophotons and <b>Virtual EM Field of a Bio-organism</b> . . . . .	273
The Priore Machine. . . . .	273
The Neurophone. . . . .	278
Soviet "Woodpecker" Signals. . . . .	279

## Part Four: Soviet Phase Conjugate Directed Energy Weapons

Weapons That Use Time-Reversed Electromagnetic Waves. . . . .	285
---	-----

<b>Glossary</b> . . . . .	297
---------------------------	-----

<b>Bibliography</b> . . . . .	329
-------------------------------	-----

# List of Photographs

1. The Vestigia mystery light experiment (© Vestigia, Stanhope, NJ. Used by permission.) . . . . .	37-38,40
2. Hyperfield flux in a magnetic field (Courtesy George Meek). . . . .	44-45
3. Remote viewing (Courtesy Dr. H.E.Puthoff) . . . . .	53
4. The Moray radiant energy device (©Dr. T.Henry Moray. Used by permission.) . . . . .	54-55
5. An Atlantean power crystal? (Courtesy Al Bielek). . . . .	59
6. The crystal skull (©El Cariso Publications. Used by permission.) . . . . .	62
7. Metal Bending (© <i>New Realities</i> . Used by permission.) . . . . .	66
8. Clockwork patterns (© Mrs. Stella Lansing. Used by permission.) . . . . .	67
9. Displacement effect (Courtesy George Meek and Paul Trovillo). . . . .	68
10. Pavlita's psychotronic generators (Courtesy James L. Hickman). . . . .	69-70
11. Cell-like invisible tulipoidal forms (©Trevor James Constable. Used by permission.) . . . . .	72
12. Form for potential materialization (©Trevor James Constable. Used by permission.) . . . . .	73
13. New Mexico UFO (Courtesy Wide World Photos). . . . .	75
14. Oregon UFOs (Courtesy Project Bluebook). . . . .	77
15. Black Ring UFO (Courtesy Project Bluebook). . . . .	78
16. Anchor patterns (Courtesy Ira Maxey, Project Bluebook, Brad Steiger, Fay Clark) . . . . .	79-80
17. Bifringement (Courtesy Project Bluebook). . . . .	81
18. UFO in water (Courtesy Project Bluebook). . . . .	81
19. UFO in clouds (Courtesy Project Bluebook). . . . .	83
20. UFO seen by author (Courtesy of the late Ray Palmer). . . . .	83
21. Second Billings UFO (© 1978 The American Association of Meta-Science). . . . .	85
22. Spanish UFO (Courtesy Spanish National Air Ministry). . . . .	91
23. Ohio UFO (Courtesy <i>Columbus Evening Dispatch</i> ). . . . .	91
24. Heflin UFO (Courtesy Rex Heflin). . . . .	92-93
25. Falkville spaceman (Courtesy Wide World Photos). . . . .	96
26. Men-in-black coin (Courtesy Warren York). . . . .	98
27. Sasquatch (Courtesy Wide World Photos). . . . .	101
28. Bigfoot cast (Courtesy Wide World Photos). . . . .	102
29. The strobe effect . . . . .	106-107
30. Kirlian photography (Courtesy Danniell H. Kientz). . . . .	108-110
31. Interaction of biofield, thought, and spark discharge (Courtesy James L. Hickman) . . . . .	112-113
32. Psychic surgery (Courtesy George Meek). . . . .	115
33. Kindling of thought bioenergy in snow (Courtesy Mrs. Ann Baune). . . . .	116
34. A deliberate experiment with kindling (© 1978 The American Association of Meta-Science). . . . .	117
35. Fay Claris "Fireflies" (Courtesy Fay dark). . . . .	120
36. "Too" fighters . . . . .	121
37. Pleiosaur-like creature hauled from the sea by Japanese fishermen Courtesy World Wide Photos). . . . .	122
38. Loch Ness monster (© Academy of Applied Science, Boston). . . . .	124
39. Cattle mutilation (Courtesy Tom Adams and Walt Andrus). . . . .	125
40. Big Mama (Courtesy Bill Jackson). . . . .	126
41. Hieronymus device (Courtesy James B. Beal). . . . .	219
42. Ghost Rockets (Courtesy of the late Ray Palmer). . . . .	244

# List of Figures

1. Hyperfield circulation patterns above a magnetized railroad track . . . . .	47
2. The cyborg effect and orthorotational sensitivity. . . . .	49
3. Reality: a paranormal bridge with two ends. . . . .	133
4. A fundamental correction to classical logic . . . . .	137
5. A physical example. . . . .	139
6. Primitive perception. . . . .	143
7. Two-slit experiment . . . . .	147
8. Photon quenching of the paranormal. . . . .	150
9. Raindrop model of quantized change. . . . .	154
10. All mass is charged: everything is electrical. . . . .	161
11. Death transmission via the paranormal channel. . . . .	167
12. Typical Hieronymus detector. . . . .	173
13. Biofield concepts. . . . .	181
14. Rotation of 3-D frames. . . . .	182
15. Mass is re-rotation of hyperspatial flux. . . . .	183
16. Einstein's spherical model of the cosmos. . . . .	188
17. Adding and subtracting dimensions. . . . .	190
18. Turning a thing into its opposite. . . . .	192
19. Multiple realities (many worlds). . . . .	195
20. Clustered orthogonal worlds. . . . .	197
21. Crosstalk between multiple realities. . . . .	200
22. Biofields: time-clustered orthoframes. . . . .	201
23. Hyperfield flux in a magnetic field. . . . .	203
24. Life and death. . . . .	204
25. Consciousness, life, and intent. . . . .	207
26. The holographic hyperchannel effect. . . . .	210
27. Output of stage i. . . . .	211
28. Layers of consciousness. . . . .	213
29. Dreams are unresolved conflicts. . . . .	216
30. Collective conflict initiates prophetic tulpoids. . . . .	219
31. Examples of UFO waves. . . . .	227
32. 1973 Contactee wave. . . . .	228
33. Cattle mutilations. . . . .	231
34. Induction of Legionnaire's disease. . . . .	232
35. Hyperspace howitzer operation (2 figures). . . . .	235
36. Nuclear Hyperspatial howitzer. . . . .	237
37. Amidcourse ABM system. . . . .	240
38. A terminal ABM system. . . . .	248
39. Sweep Mode: sweeping away a nuclear detonation. . . . .	249
40. ZARG. . . . .	252



# FOREWORD

by John White

This book deals in a comprehensive fashion with such a vast array of topics — from physics, psychology and evolution to advanced weaponry, military strategy and international politics — that many of you may become anxious, even fearful on reading it. In fact, this assembly of previously uncorrelated information and scientific breakthrough may be the most disturbing you have ever received.

This cannot be helped. This book represents an important step in our efforts to avoid global war involving not only nuclear armaments but also what appears to be a revolutionary development in Soviet military technology — psychotronic weapons. They are the modern equivalent of the legendary invincible sword, Excalibur.

The author is former U.S. Army officer Lt. Col. Thomas E. Bearden, now retired. During his twenty-year military career specializing in artillery, nuclear weapons, and military intelligence, Tom has pondered and researched many subjects that he covers here. His access to the full range of both military and NASA documents will be evident in his book. What may become highly classified data in the future is being revealed to you, our nation's ultimate policymakers, for an urgent reason that Tom has called Operation Fer-de-Lance, the presumed Soviet plan for domination of the planet through nuclear-psychotronic aggression and warfare. For the moment I would simply like to note two statements that indicate the basis for our sense of urgency:

1. On 13 June 1975, Soviet Premier Leonid Brezhnev urged a ban on research and development of new kinds of weapons "more terrible than anything the world has known."

2. In January 1977 former Air Force Chief of Intelligence, Maj. Gen. George J. Keegan (Retired) told *Newsweek* magazine, "The Soviets are working on dramatically exotic new weapons, twenty years ahead of anything ever conceived in the U.S. — so awesome as to lead the Soviets to believe that in the coming decade they would be capable of total neutralization of our ballistic and submarine missiles."

The U.S. military intelligence community interprets these signs in conventional terms as perhaps indicating the development of laser rays. Tom disagrees. His book will deal with the possibility that these weapons are psychotronic or parapsychical in nature.

In fact, we can say that in a strict sense, these are not weapons but devices — breakthrough technology with an enormous potential for the destruction of humanity. They are a second- or third-generation outgrowth of radionic devices presently used in unorthodox medicine for diagnosis and healing. Extremely compact, they could be carried in a suitcase and planted near targets — ICBM sites, communications centers, etc. Even if one of these devices were found and examined, it would only look like an electronic switching circuit or a small transmitter/receiver set, rather than a bomb or explosive.

The energy and the mechanism involved in psychotronic damping of nuclear, chemical or electromagnetic technology is, from all indications, unrecognized by official Western science but nevertheless inherent in it. That also has been deeply pondered by Tom, and this book will give a full explanation of the physics, mathematics and technology involved. It is not an exaggeration to say, as Tom does, that the explanation offers a "physics of metaphysics" — a fully developed theory of paranormal phenomena that elegantly unites physics and psychology. The ramifications of what Tom calls perception theory lead into every field of human knowledge and inquiry with revolutionary results — from science, theology and philosophy through the full spectrum of paranormal phenomena such as UFO's and psychokinesis into the elementary school classroom, the supermarket shopping basket and the voting booth. They most certainly lead into the safety of your homes and the integrity of your minds.

Before you turn to *The Excalibur Briefing*, I want to leave you with these thoughts. The material you are about to read will certainly be denied by our own government and military and probably by a major segment of the scientific community. It is not unlikely that Tom will be dismissed as a paranoid crackpot. Such tactics have been employed before against brilliant, courageous people who challenge the fundamental dogma of the establishment as Tom does here. Nevertheless, I want to reassure you that Tom is sane, sober, and serious.

Of course, such a person could still perhaps be mistaken. In that regard, I believe you will find Tom's presentation to be persuasive. He himself is careful to distinguish speculation from fact, inference from descriptive statement. Even if Tom were paranoid, however, the question arises: *What if there is good reason for paranoia?* To phrase it positively: We should welcome truth and enlightening insight whenever offered, regardless of the source. Do not let *ad hominem* arguments affect your critical judgment about the soundness of this presentation. Assess the work, not the man, for the work is always greater. And having judged the work affirmatively, render true acknowledgement — not lip service — by sharing the ideas in this book with others. Only free, informed, vigorous effort in the court of world opinion can defuse the possibility of Operation Fer-de-Lance and psychotronic mind control leading to total enslavement of the human race.

In closing, I want to point out that Tom's fundamental concern is the unification and evolution of the human species to a higher form of life through a process that he terms "mind linkage." This stage of growth to higher consciousness is explored in the latter part of the book. It is a breathtaking portrait of how the spirit of science can lead to a science of the spirit, to a physics of metaphysics.

# INTRODUCTION TO THE SECOND EDITION

Since the first edition of *Excalibur Briefing* was published, a great deal of progress has been made on the actual physics of unusual and paranormal phenomena. Indeed, so much progress has been made in the ten years since the 1978 or so cutoff of most of the Excalibur material, that I really should rewrite the entire book. However, time will not permit that luxury at present I am simply too hard-pressed in the strenuous efforts to move a free energy machine to market and to convince our government that unorthodox Soviet superweapons present us with a problem of the gravest magnitude.

Accordingly, the inclusion of one of my latest papers, "Soviet Phase Conjugate Directed Energy Weapons," together with an updated glossary for the entire emerging field, will have to suffice.

The important thing is that **a separate new field of physics is beginning to emerge**. It turns out that what we've gotten on to is a unified field—one can now turn electromagnetic energy into gravitational energy and vice versa. Indeed, gravitational potential is now revealed as simply infolded electromagnetics, and electromagnetics is simply the unfolding of the internal contents of gravitational potential.

Colleagues have already proven it on the laboratory bench, by building both "free energy" devices and practical antigravity devices.

This new, extended electromagnetics—electrogravitation—I have dubbed **scalar electromagnetics**. The key to it is to let the EM force fields fight themselves to a "cancellation," forming a vector zero. If we do this in a nonlinear medium (modulator), the summing/multiplying EM vector forces are locked together and remain as an infolded EM system inside the EM vector zero. This now is a gravitational system. By merely varying (in phase) the summing EM components, one varies the local energy density of vacuum. Rigorously that is a gravitational wave. Further, it is a very powerful G-wave, for we are utilizing EM forces some 1042 times as strong as the normal weak G-force.

Classical EM has taught us to simply discard the components in the zero vector summation, replacing the system of opposing EM forces with a vector EM zero. This of course makes all vector EM zeroes equal. However, it totally ignores the space-time/vacuum stress of the summed forces, and the resulting gravitational implications. Therefore we have been taught to ignore any gravitational aspects of normal EM circuits, and indeed we proceed to release the G-stress effects in the circuits when we build them as we have been taught

Ordinary EM represents the release of the internal stress of gravity. By teaching us to make nonzero EM, scientists have taught us to always release electrogravitational potentials as electromagnetic forces. Thus in classical EM—and in most of the circuits we build—the EM force fields are the primary causative agents. Classically, when these force fields reduce to zero, there is no more electromagnetics going on. That is true, but there can still be a very large amount of gravity and inertial effects going on!

However, quantum mechanics teaches us that the EM force fields are not at all the primary causes. Instead, the potentials are the primary things; EM forces are simply made from these potentials by differentiating operators. And when the force fields are zero, the potentials still exist. Further, when these "forceless potentials" interfere—

even at a distance—real EM effects can still be obtained, in total violation of ordinary EM and ordinary mechanics!

This is called the Aharonov-Bohm Effect, and in 1986 it was finally proven to most physicist's satisfaction. Only the most diehard skeptics still object to it, according to *Physics Today*, January 1986.

At any rate, when we have zeroed the E and B fields, we can still have the potentials, according to modern physics. These potentials can interfere to produce electromagnetic force effects—even at a distance.

Further, the zero summation can be dynamic; that is, the vector components can be varying, so long as they always sum to a zero vector. Actually such a zeroed system now has an infolded, deterministic pattern of dynamic forces, according to the pattern we deliberately construct. Further, the energy of each force component infolded is varying, and thus the overall energy density of local vacuum is varying.

As we said, rigorously this defines a gravitational wave. So the zero-vector approach allows EM wave energy to be turned directly into gravitational wave energy. Now it is the curvature of spacetime that is being varied locally. That's a really astounding thing.

We can now deliberately engineer the vacuum/spacetime itself, with all that that statement implies. Locally we can bend spacetime itself, which Einstein assumed could never be done except by a huge collection of mass—such as a sun, star, neutron star, etc. But here we can do it with simple things such as opposing coils, opposing E-fields, etc. We've just violated one of the sacrosanct, severely limiting assumptions of ordinary (Einstein's) general relativity!

That is, up to now most Western physicists have assumed that the local space-time/vacuum cannot be curved. They assume that, where we the observer and the laboratory instruments are, only special relativity applies. Locally the observer always has a "Lorentz frame," in that view. This assumption (the local Lorentz frame) means that all the conservation laws apply, and physical reality stays well-behaved where the laboratory is and where we are. Ordinary relativity becomes just a sort of "special relativity with distant perturbations."

The only curvature of spacetime of any consequence is only to be found at or near distant stars, suns, black holes, and other huge collections of mass, in this highly restrictive view. Further, this assumption implies that one can never have an experimental general relativity, since where one is experimenting (locally) there is always essentially zero spacetime curvature!

However, one need not have such a formidable restriction at all. Two bucking transformers can make a B-field vector-zero a little bit. More complex circuits can easily be designed to sum (or multiply) force fields to zero very well. When we do this zero summation, we also get an amazing gain as follows: Consider two electrons in free space. As is well known, the electric field force (repulsion) between them is about  $10^{42}$  times as strong as the gravitational field force (attraction) between them. So the electric force is so very much stronger that the comparatively weak gravitational force can be entirely neglected, in most applications. However, if we "strangle" that electric field force by zero summation, all the opposing electric forces are converted directly into gravitational potential!

Interference of two such potentials can directly generate gravitational forces. So, if

we could zero-sum their E-fields perfectly, we could instantly amplify the gravitational force between the two electrons by a factor of  $10^{42}$ . With such a gravitational force amplification factor, our altered "electrical" circuits would actually become powerful electrogravitational circuits. Further, appreciable gravity effects would now be experienced by any mass, object, or device exposed to the action of the circuits. This is the fundamental secret that Nikola Tesla discovered, one which he never openly revealed.

Further, by locking opposing EM waves together, we may easily construct purely scalar EM (electrogravitational) waves and beams. In such case, amazing new phenomena are encountered: (1) one can increase or decrease the mass and inertia of an object; (2) one can produce a unilateral force in and on each and every nucleon in a body, thus accomplishing the long-sought "antigravity"; (3) a unilateral force drive—a "space drive"—can be constructed; (4) transmutation of elements becomes fairly simply done, with miniscule energy; (5) effects at a distance—such as cold explosions or hot explosions—can be accomplished; (6) negative energy and negative time effects can be created and utilized; (7) Newton's third law can be manipulated and violated at will; (8) negative entropy effects can be created and utilized; and (9) direct energy extraction from the vacuum can be accomplished, etc. So many new effects are encountered that it will take a generation of graduate students and university laboratories to get a good handle on most of them.

The reader is urged to remember these rules: (1) The destructive interference of scalar EM waves (electrogravitational waves) produces EM energy in, or extracts it from, the interference zone. (2) The destructive interference of ordinary EM waves produces gravitational potential energy. (3) The release of the ordinary EM force fields represents the bleed-off of a 5-dimensional gravitational potential as ordinary electromagnetics. (4) The bottling-up of the ordinary EM force fields represents the forced bleed-off of a 5-dimensional gravitational potential as ordinary 4-dimensional gravitational force. (5) The EM field and the ordinary (4-space) G-field are just separate bleed-off s of the same 5-dimensional gravitational potential field.

Thus, I make no bones about it; we have a new physics in the offing—one that is eminently practical and easily engineered by any modern electromagnetics laboratory.

Since the first edition of this book was issued, it has also become obvious that at least two other phenomena are involved in UFOs, and intermingled with the "materializations from the collective unconscious" true UFO phenomena. These two additional things are:

(1) A great number of "lights at night" and "mysterious fireball" type phenomena—and giant balls of light and glowing hemispheres of light of gigantic size—are actually due to deliberate Soviet long range, high energy, real-time holography using phase conjugation. These phenomena are to accomplish orientation and alignment of giant Soviet weapons, and at the same time deliberately evoke UFO reports and scientific skepticism, providing perfect deception.

(2) Several nations of the world—at least two—have been building and flying antigravity spaceships all over the solar system, since the early 1950's. A very small number of UFO ship reports and encounters are due to these ships and their crews. However, control of these ships is not under any duly elected government, but passes out of the government concerned, into and under the control of some mysterious group

which I loosely refer to as "the control group." This is the same mysterious group which has been suppressing free energy and antigravity inventors and inventions for a great number of years.

Thus in *Excalibur Briefing* we are still addressing the primary UFO phenomena: Materializations from the collective human unconscious. Coverage of the other two parts of the overall reported UFO phenomena will be made elsewhere.

So it seems that, under my hard-pressed circumstances, the best thing to do for the second edition of *Excalibur Briefing* is to include something that shows some of the drastic progress that has been made. By adding a glossary and a current paper, the book will also be made much more usable. I also have prepared an index for the first edition, but it cannot be included because of space limitations. Admittedly that is regrettable and still not the optimum, but it will have to suffice. Perhaps in the future I will be able to do a complete rewrite of the book, for *Excalibur III*.

Until then, I ask the reader's indulgence and understanding.

\* \* \*

In the first edition we accented the hyperspatial aspects of the problem, but also pointed out that higher dimensional spaces and deeper nested levels of virtual state are in fact one and the same thing. The reader should keep in mind that when we "inter-*nest*" vector zero systems, we are performing direct engineering in hyperspace.

Let me be more specific. When you zero sum a group of EM force vectors, you place those component vectors "inside the zero," so to speak. In modern language you have placed ordered patterns directly inside the violent flux of virtual particles comprising the vacuum. The modern concept of the vacuum is that it is like a seething plasma or gas. However, it's a very strange gas, for each particle arises spontaneously out of nowhere (according to quantum mechanics), and almost immediately turns into something else and/or disappears. Thus the vacuum plasma or gas is rather peculiar; the particles comprising it appear and disappear so rapidly that they cannot individually be detected. However, while a virtual particle exists, it is in motion, and so a violent flux of these "phantom particles" comprises the vacuum/spacetime.

However, just as many fleeting particles in the vacuum are moving backward in observer time as are moving forward in it! So this wild "vacuum gas" of ghost particles exists in both positive and negative time at once!

Anyway, when we make a zero vector EM system, each component force in the summation represents a gradient in this virtual particle flux. That is, we have "patterned" and organized the flux—polarized it, so to speak. And that now overturns one of the fundamental assumptions of quantum mechanics.

Quantum mechanics assumes that the violent flux of vacuum ghost particles is totally randomized. That is, no deterministic pattern exists in the flux. These virtual changes collect or cohere statistically, not deterministically, in the standard assumption. When they happen to collect/cohere sufficiently, the threshold of an observable quantum change is breached, and a quantum change occurs.

It can readily be seen that, in the ordinary view, the occurrence of these quantum changes is totally statistical. And indeed it is, so long as the virtual particle flux is randomized. However, with zero vector summation (or multiplication) we have produced

deterministic patterns in the flux—and hence in the cohering and collecting of this flux on observable charged particles. Therefore, these deterministic "virtual state" ordered patterns will result in the appearance of deterministic patterns in the occurrence of observable quantum changes.

Now we have begun to engineer physical reality directly; that is, one can now begin to pre-determine which statistical change shall be favored, or in the extreme case, which one shall occur, and whether or not it shall even occur at all.

The renowned physicist, David Bohm, has written a theory of "hidden variables" which could fit and describe all of physics (nothing out there contradicts it). It has largely been ignored, and will continue to be ignored unless it can show appreciable application that normal theory cannot cover. With the scalar EM approach, we can now directly provide hidden EM force field vectors, ordering the virtual state vacuum flux, and we may vary these ordered virtual patterns at will to produce startling new results in charged particle systems. So now we can directly engineer Bohm's "hidden variables," and the vacuum itself—something ordinary theory cannot cover. Drastic changes in the physicist's view of fundamental physical reality, and of what he can do about it, now result

But to return: We wish to engineer additional hyperspaces. (The first zero-vector summation places the component vectors in the fifth dimension.) If we take one of the component EM vector forces in the first zero vector summation, and we then take a point on it as yet another "reference zero", we may encapsulate a second series of zero-system summation vectors into and within that zero-point. In this case we have placed these second vectors into yet a deeper level of virtual state vacuum. That is, we have reached into yet another hyperspace with our engineering and control. Indeed, we have placed the second system EM vectors into the sixth dimension. So we have become true hyperspace engineers.

The process is repeatable as desired. We may reach any hyperspace we wish, as our technology and control develop.

Now we see the impact In modern Kaluza-Klein geometry, one needs about 11 or so dimensions if one is to account for quarks, charm, etc. Now we have a direct tool to reach into any one or all of these hyperdimensions and affect the exact particle or component desired. We will be able to engineer matter—including the nucleus, and including inside the proton and neutron—in almost any way we wish. It all follows from scalar electromagnetics, which allows the direct engineering of hyperspace in all its dimensions.

Remember, engineering in hyperdimensions is just the engineering of nested levels of vacuum potentials. Even more startling, we can also place "thoughts" and effects directly in the mind itself, including the unconscious mind.

As we stated in the first edition of this book, we may model the mind as simply an objective 3-space, three turns away from the 3-space of the ordinary physical world. If we nest two or more additional zero-vector systems in our first one, then we have placed affects ("vectors") directly inside the mind itself. If we know the code of the human brain-tuner, we can now manipulate the mind directly. Electromagnetically, by scalar EM. And it appears that the Soviet Union has begun to reach this frightening capability.

Disease patterns may be induced upon ordinary EM carriers in the same manner,

by nesting the zero-vector systems. That is, of course, if one has measured the scalar patterns evident in the induced disease, say, in the Kaznacheyev-type experiments with the desired disease patterns. The reverse is also true: Nesting the patterns in the proper context on EM field carriers can cure diseases such as cancer and leukemia, as evidenced by the Priore device.

One can also make a practical "free energy" device by setting up a standing scalar wave resonance in a localized region or device. From the "high stress" point to the "low stress" region of vacuum formed by such a standing scalar wave, a literal "river of energy" is flowing in the vacuum itself. Once the river is established, only the "leakage" need be replenished. Hence, if one builds a special sort of "paddle wheel" to react with the river and turn in it, one obtains shaft power freely from the localized curvature of spacetime. In that case, an ordinary generator can be driven by the shaft torque to provide very cheap, or "free," electrical energy.

Several inventors—three of whom I work with in one respect or another—now have demonstration models of such machines, which take diverse forms.

Because of the extreme importance of these emerging potentialities, in recent years I've concentrated intensely upon the properties of the vacuum as spacetime, and uncovered shortcomings (and downright errors in many cases) in ordinary physics and electromagnetics. Slowly the scalar EM picture has emerged, and a series of papers has been written and published to develop the concepts of the new approach.

The scalar approach also includes the ability to engineer negative energy and negative time flow. The reader is referred to Chapter 4, "Extraordinary Physics," of my forthcoming book, *AIDS: Soviet First Strike*, Tesla Book Co., P.O.Box 1649, Greenville, Texas 75401 for a summary of the vast importance of the time-reversed EM wave (phase conjugation).

Let me here just accent a rule of great importance: It is actually the key to negative energy, negentropy, antigravity, free energy, transmutation, Tesla's wireless transmission of energy at a distance without loss, Tesla's original magnifying transmitter, and many other things.

First we need the expression CPTEGS, where C is charge, P is parity, T is time flow, E is energy, G is gravity, and S is entropy. We shall be concerned with the algebraic sign of each term in the expression. The rule deals with photon interaction with a charged particle inside an atom. Normally, incident photons interact with an electron in the electron shells, so C is normally negative. This produces normal parity, and causes the normal or positive flow of time, so T is normally positive. The normal kinds of energy, gravity, and entropy are experienced, so energy is positive, gravity is positive (attraction), and entropy is positive (progressive interactions in a system tend to more and more disorder).

The astonishingly powerful rule is this: In a photon interaction with a charged particle in an atom, if any one of the terms of the expression CPTEGS is reversed in algebraic sign, all the other terms are reversed in algebraic sign.

Thus if one makes scalar EM, the wave (and its photons) passes through the electron shells and interacts with (is absorbed in, and raises to an excited state, which then decays to emit a wave and photons) the highly nonlinear, positively charged nucleus. This represents a reversal of C, hence a reversal of P, T, E, G, and S also.

Consequently, a time-reversed wave—a phase conjugate replica of the incident



wave—is emitted by the decaying excited nucleus. In nonlinear phase conjugate optics, this is the mechanism that produces the phase conjugate wave. This is also the mechanism that produces a very large amplification of the incident wave when a "pump wave" (two waves 180 degrees out of phase) are used in the nonlinear (modulating) medium of the phase conjugate mirror.

(The reader is referred to any good book or summary paper on phase conjugate optics; for example, see David M. Pepper, "Nonlinear optical phase conjugation," *Optical Engineering* 21(2), Mar./Apr. 1982, p. 156-183.).

When one pumps a phase conjugate mirror material sufficiently, then "tickles" the release of the total nuclear excitation energy as phase conjugation replica waves (negative energy), appreciable negative time is produced in the decaying nuclei of the mirror. In negative time, gravity is a repulsion, not an attraction. The mirror thus produces antigravity, and gets lighter. If it is forced to sufficiently high amplification, it can be made to float in air. At higher amplification still, it will accelerate upward.

Some other references of interest to this new edition follow:

1. Robert A. Fisher, Ed., *Optical Phase Conjugation*, Academic Press, New York, 1983. Collection of papers. An extensive bibliography is given at the end of the book.
2. Ya. Zel'dovich, N. F. Pilipetsky, and V. V. Shkunov, *Principles of Phase Conjugation*, Vol. 42, Springer Series in Optical Sciences, Theodor Tamir, Ed., Springer-Verlag, New York, 1985.
3. Amnon Yariv, *Optical Electronics*, Third Edition. Holt, Rinehart and Winston: New York, 1985. See particularly Chapter 16: "Phase Conjugate Optics—Theory and Applications."
4. Y. Aharonov and D. Bohm, "Significance of Electromagnetic Potentials in the Quantum Theory." *Physical Review*, Second Series. 115(3), Aug. 1, 1959. p. 485-491.
5. R. G. Chambers, "Shift of an electron interference pattern by enclosed magnetic flux." *Physical Review Letters*. 5(1), My 1, 1960. p. 3.
6. Richard P. Feynman, Robert B. Leighton, and Matthew Sands, *The Feynman Lectures on Physics*. Volume n, Section 15-5, p. 15-8 to 15-14.
7. E. T. Whittaker, "On an expression of the electromagnetic field due to electrons by means of two scalar potential functions." *Proc. Lond. Math. Soc.*, Vol. 1, 1903. p. 367-372.
8. T. E. Bearden, *Solutions to Tesla's secrets and the Soviet Tesla weapons*. Tesla Book Co., Greenville, TX, 1981.
9. T. E. Bearden, *Tesla's secret and the Soviet Tesla weapons*. Presented in absentia at the First International Unorthodox Energy Symposium, Toronto, Canada, 1981. Available from Tesla Book Co.
10. T. E. Bearden, "Soviet weather engineering over North America." 1-hour videotape, 1985. Available from P.O. Box 1472, Huntsville, AL 35807.
11. Gwynne Roberts, "Witness to a super weapon?" *The Sunday Times*, London, England, Aug. 17, 1980.
12. Greg Rippee, "Mushroom cloud sighted off Japan." *Los Angeles Daily News*, Apr. 11, 1984. p. 1, 8.
13. Martin Ebon, "Moscow, June 11, 1977." in his *Psychic Warfare: Threat or Illusion*. McGraw-Hill Book Co., New York, NY, 1983. p. 1-11.
14. A. K. Lapkovskii, "Relativistic kinematic equations and the theory of continuous media." *Soviet Physics Journal* 21(6), June 1978-Dec. 1978.
15. B. N. Belyaev, "On random fluctuations of the velocity of light in vacuum." *Azvestiya Vysshikh Uchebnykh Zavederdi, Fizika*. 11, Nov. 1980. p. 37-42.
16. Ingram Bloch and Horace Crater, "Lorentz-invariant potentials and the non-relativistic limit" *American Journal of Physics*. 49(1), Jan. 1981. p. 67-75.

17. T. E. Bearden, *Comments on the new electromagnetics: Part I: discrepancies in present EM theory*. Tesla Book Co., Greenville, TX. 1982.
18. T. E. Bearden, *Comments on the new electromagnetics: Part 2: the secret of electrical free energy*. Tesla Book Co., Greenville, TX. 1982.
19. T. E. Bearden, *Toward a new electromagnetics: Part III: clarifying the vector concept*. Tesla Book Co., Greenville, TX. 1983.
20. T. E. Bearden, *Toward a new electromagnetics: Part IV: vectors and mechanisms clarified*. Tesla Book Co., Greenville, TX. 1983.
21. T. E. Bearden, "USSR: New beam energy possible?" *Defense & Foreign Affairs Daily*. 13(111), June 12, 1984. p. 1-2.
22. T. E. Bearden, *Star Wars Now! The Bohm-Aharonov effect, scalar interferometry, and Soviet weaponization*. Tesla Book Co., Greenville, TX. 1984.
23. T. E. Bearden, "A conditional criterion for identity, leading to a fourth law of logic." *Pursuit*. 13(1), Winter 1980. p. 6-10.
24. Max Frankel, "Khrushchev says Soviet will cut forces a third; sees 'fantastic' weapon." *New York Times*. Jan. 15, 1960. p. 1.
25. David Bohm and B. J. Hiley. "On the intuitive understanding of nonlocality as implied by quantum theory." *Foundations of Physics*. 5(1), Mar. 1975. p. 93-109.
26. Derek Wood, "USA probes mystery cloud reported off Japan." *Jane's Defence Weekly*. 1(18). May 12, 1984. p. 716.
27. Yossef Bodansky. "Soviets 'testing chemical agents in Afghanistan'." *Jane's Defence Weekly*. 1(13), Apr. 7, 1984. p. 508.
28. "Explosive events seen on Soviet island." *Aviation Week & Space Technology*. Sep. 26, 1983. p. 31.
29. Archibald E. Roberts, "The Tesla Factor." *Bulletin. Committee to Restore the Constitution*, POB 966, Fort Collins, CO 80522. Nov. 1984. p. 1-6.
30. See a series of articles by C. B. Baker in *Youth Action News*, POB 312, Alexandria, Virginia 22313. "Diabolic Soviet Warfare," Nov. 1984; "Soviet Weather Mayhem," Nov. 1983; "The Soviet Zapping of America," Dec. 1986; "Fifth Column Treachery," May 1987, and others.
31. D. W. McCann, "The Enhanced-V: a satellite observable severe storm signature." *Monthly Weather Review*. 111, 1978. p. 887-894.
32. I. J. R. Aitchison, "Nothing's plenty: the vacuum in modern quantum field theory." *Contemporary Physics*. 26(4), 1985. p. 333-391.
33. G. E. Stedman, "Ring interferometric tests of classical and quantum gravity." *Contemporary Physics*. 26(4), 1985. p. 311-332.
34. Peter Hobbs, "Holes in clouds?" *Weatherwise*. 38(5), Oct 1985. p. 254-258.
35. T. D. Lee, *Particle physics and introduction to field theory*. Harwood Academic Publishers, New York, NY 1981. Second printing with corrections, Nov. 1982.
36. Ruggero Maria Santilli. *Ethical probe on Einstein's followers in the USA: An insider's view*. Alpha Publishing, POB 82, Newtonville, MA 02160. 1984.
37. Bryan G. Wallace, "The great speed of light in space covered." *Scientific Ethics*, 1(1), Feb. 1985. p. 2-3.
38. Bryan G. Wallace, "Letters to the Editor." *Physics Today*. 36(1), 1983. p. 11,
39. Bryan G. Wallace, "Letters to the Editor." *Physics Today*. 37(6), 1984. p. 15.
40. M. E. Ash, I.I. Shapiro and W. B. Smith. *Astron. J.* 72, 1967. p. 72.
41. Bryan G. Wallace. *Spectrosc. Lett.* 4, 1971, p. 79.
42. Bryan G. Wallace. "The unified quantum electrodynamic ether." *Foundations of Physics*. 3, 1973. p. 381.
43. D. E. Thomsen, "Was a fifth force felt?" *Science News*. 129(3), Jan. 18, 1986. p. 38.
44. S. Olariu and I. Iovitzu Popescu. "The quantum effects of electromagnetic fluxes." *Reviews*

- of Modern Physics*. 57(2), Apr. 1985. p. 339-438. Thorough review of the entire subject of the Aharonov-Bohm effect, from the standpoint of conventional physics. A very comprehensive list of references is included.
45. V. I. Denisov and A. A. Logunov. "The inertial mass defined in the general theory of relativity has no physical meaning." *Teoreticheskaya i Matematicheskaya Fizika*, 51(2), May, 1982. p. 163-170. (in Russian). English translation in *Theoretical and Mathematical Physics*
  46. A. A. Vlasov and V. I. Denisov. "Einstein's formula for gravitational radiation is not a consequence of the general theory of relativity." *Teoreticheskaya i Matematicheskaya Fizika*. 53(3), Dec. 1982. p. 406-418. (in Russian). English translation in *Theoretical and Mathematical Physics*.
  47. Richard A. Blade, "Modification of Maxwell's equations in free space to account for nonzero photon mass and scalar electromagnetic waves." *Proceedings of the Tesla Centennial Symposium*, an IEEE Centennial Activity, Colorado College, Colorado Springs, Colorado, Aug. 9-11, 1984, p. 91-92.
  48. Jack Y. Dea. "Scalar fields: their prediction from classical electromagnetism and interpretation from quantum mechanics." *Proceedings of the Tesla Centennial Symposium*, 1984. p. 94-98.
  49. Robert W. Bass. "Self-sustained non-Hertzian longitudinal wave oscillations as rigorous solutions of Maxwell's equations for electromagnetic radiation." *Proceedings of the Tesla Centennial Symposium*, 1984. p. 89-90.
  50. T. E. Bearden. "Tesla's electromagnetics and its Soviet weaponization." *Proceedings of the Tesla Centennial Symposium*, 1984. p. 119-138.
  51. Theodor Kaluza. *Sitz. Berlin Preuss. Acad. Wiss.* 966, 1921.
  52. O. Klein. *Z. Phys.* 37.895, 1926.
  53. Charles W. Misner, Kip S. Thorne and John Archibald Wheeler. *Gravitation*. W. H. Freeman and Co., San Francisco, CA, 1973. p. 19-21, 71-72, 163-165, 367-369. Presents the limiting assumptions imposed on general relativity, to provide the severely restricted "ordinary general relativity" taught in almost all Western universities. The Soviets are not nearly so attached to such artificial assumptions.
  54. V. I. Denisov and A. A. Logunov. "New theory of spacetime and gravitation." *Teoreticheskaya i Matematicheskaya Fizika*, 50(1), Jan. 1982. p. 3-76. (In Russian). English translation in *Theoretical and Mathematical Physics*, 50(1), July 1982. p. 1-48.
  55. Raymond C. Gelinus. "Apparatus and method for determination of a receiving device relative to a transmitting device utilizing a curl-free magnetic vector potential field." U.S. Patent No. 4,447,779. May 8, 1984.
  56. Raymond C. Gelinus. "Apparatus and method for modulation of a curl-free magnetic vector potential field." U.S. Patent No. 4,429,288. Jan. 31, 1984.
  57. Raymond C. Gelinus. "Apparatus and method for demodulation of a curl-free magnetic vector potential." U.S. Patent No. 4,429,280. Jan. 31, 1984.
  58. Raymond C. Gelinus. "Apparatus and method for transfer of information by means of a curl-free magnetic vector potential field." U.S. Patent No. 4,432,098. Feb. 14, 1984.
  59. Thomas E. Phipps, Jr. "Critique of accepted theories of special relativity and electromagnetism." *Scientific Ethics*. 1(2), Apr. 1985. p. 17-23.
  60. Bertram Schwarzschild. "Currents in normal-metal rings exhibit Aharonov-Bohm effect" *Physics Today*. 39(1), Jan. 1986. p. 17-20.
  61. William J. Hooper, "All-electric motional electric field generator," U.S. Patent No. 3,610,971. Oct 5, 1971.
  62. William J. Hooper, "Apparatus for generating motional electric field." U.S. Patent No. 3,656,013. Apr. 11, 1972.

63. William J. Hooper, *New horizons in electric, magnetic and gravitational field theory*. Akron, Ohio. Electrodynamic Gravity, Inc. 1974.
64. Oleg D. Jefimenko. "Gravitation and antigravitation." *Proceedings of the West Virginia Academy of Science*. 52(2), 1980. p. 106-118.
65. R. C. Jennison. "Relativistic phase-locked cavities as particle models." *Journal of Physics A: Mathematical and General*. 11(8), Aug. 1978. p. 1525-1533.
66. T. D. Keech and J. F. Corum. "A new derivation for the field of a time-varying charge in Einstein's theory." *International Journal of Theoretical Physics*. 20(1), 1981. p. 63-68.
67. Raymond Kromrey, "Electric generator." U.S. Patent no. 3,3374,376. Mar. 19, 1968.
68. M. J. Perry, "Magnetic monopoles and the Kaluza-Klein theory," *Am. Inst. Phys. Conf. Proc.* No. 116, 1984. p. 121-125. Kaluza-Klein theory admits soliton solutions which constitute magnetic monopoles. These monopoles have inertial mass, but no gravitational mass.
69. M. W. Kalinowski, "The nonsymmetric Kaluza-Klein theory," *J. Math. Phys.* 24(7), July 1983. p. 1835-1845.
70. D. J. Toms, "Induced Einstein-Maxwell action in Kaluza-Klein theory," *Phys. Lett. B* (Netherlands), 129B(1-2), Sept 15, 1983. p. 31-35.
71. Fritz Albert Popp et al, eds., *Electromagnetic Bio-Information. Proceedings of the Symposium*, Marburg, September 5, 1977. Urban & Schwarzenberg, Baltimore, 1979. See particularly Fritz Albert Popp, "Photon storage in biological systems," p. 123-149.
72. A. G. Gurvitsch, *Theory of Biological Field*, Moscow, 1944 (in Russian).
73. V. P. Kaznacheyev et al, "Conditions Necessary for Appearance of Distant Intercellular Interactions after UF-radiation," *Bulleten Experimentalnoy Biologii i Meditsiny*, No. 5, 1979, pp. 468-471 (in Russian).
74. Antoine Priore, "Method of producing radiations for penetrating living cells," U.S. Patent No. 3,280,816. Oct. 25, 1966.
75. David M. Rorvik, "Do the French Have a Cure for Cancer?," *Esquire*, July 1975, p. 110-111, 142-149. Excellent summary of the Priore Affair, with some details of the working of the machine.
76. J. B. Bateman, "A Biologically Active Combination of Modulated Magnetic and Microwave Fields: The Priore Machine," Office of Naval Research, London Report R-5-78, Aug. 1978. Comes very close when he states that "The possibility that some hitherto unrecognized feature of the radiation from a rotating plasma may be responsible for the Priore effects should not be dismissed out of hand..." Indeed, none of the persons who checked the machine or pondered over it knew anything about phase conjugation— which plasmas can do, and which the Priore machines did.
77. J. B. Bateman, "Microwave magic." *Office of Naval Research London Conference Report*, ONRL C-14-77, 1977.
78. R. Courrier, 1977. "Expose de M. le professeur R. Courrier secretaire perpetuel de l'Academie des Sciences fait au corsn d'une reunion a l'Institut sur les effets de la machine de M. A. Priore le 26 Avril 1977."
79. Jean-Michel Graille, *Dossier Priore: A New Pasteur Affair*. De Noel, Paris, France. 1984.
80. Thomas H. Moray, "Electrotherapeutic apparatus," U.S. Patent No. 2,400,707. Feb. 1, 1949.
81. T. D. Lee, *Particle Physics and Introduction to Field Theory*, Harwood Academic Publishers, New York, 1981. See particularly Chapter 16, "Vacuum as the source of asymmetry."
82. Royal R. Rife, "The Rife Microscopes," Apr. 28, 1939.
83. Arthur Isaac Kendall, "Filtration of bacteria; studies in bacterial metabolism," *Science* 75, Mar. 18, 1932. p. 295-301.
84. R. E. Seidel, M.D. and M. Elizabeth Winter, "The new microscopes," *Journal of the Franklin Institute*, Feb., 1944. p. 103-129.
85. Christopher Bird, "What has become of the Rife microscope?," *New Age Journal*, Mar. 1976.

86. Lida H. Mattman, *Cell Wall Deficient Forms*, CRC Press, Cleveland, Ohio. 1974.
87. T. E. Bearden, *AIDS: Soviet First Strike*, Tesla Book Co., 1987. (In press).
88. T. E. Bearden, "AIDS: Urgent Comments on Mankind's Greatest Threat, and the Secrets of Electromagnetic Healing," presented in absentia at the U.S.P.A. Annual Symposium, July 30-Aug. 2, 1987, Golden, Colorado.
89. "Tesla Electromagnetics: Weapons or Healing?", presented at the Whole Life Expo, Los Angeles Airport Hilton Hotel, Los Angeles, California, Oct 3, 1987.
90. Stefan T. Possony, "The Tesla Connection," *Defense & Foreign Affairs*, Aug. 1984, p. 12-14, 27. Highly recommended.
91. Daniel A. Walker et al "Kaitoky Seamount and the Mystery cloud of 9 April, 1984," *Science*, 227(4584), Feb. 1, 1985, p. 607-611. See also Daniel L. McKenna and Daniel A. Walker, "Mystery Cloud: Additional Observations," *Science*, 234(4775), Oct 24, 1986, p. 412-413 for update to the information in the first article.
92. T. E. Bearden, *Fer-de-Lance: A Briefing on Soviet Scalar Electromagnetic Weapons*, Tesla Book Co., Greenville, TX. 1986.
93. T. E. Bearden, "Soviet Phase Conjugate Directed Energy Weapons: Weapons That Use Time-Reversed Electromagnetic Waves," 1987 (in this publication).
94. Yossef Bodansky, "Soviets testing chemical agents in Afghanistan," *Jane's Defence Weekly*, 1(13), Apr. 7, 1984. p. 508.
95. Draft agreement introduced by Andrei A. Gromyko to the United Nations' thirtieth session of the General Assembly on Sept. 23, 1975; "Prohibition of the Development and Manufacture of New Types of Weapons of Mass Annihilation and of New Systems of Such Weapons." The first article provided that the types of these new weapons would be "specified through negotiations on the subject."
96. "Secret Speech: Did Brezhnev come Clean?", *National Review*, 29(8), Mar. 4, 1977, p. 248, 250.
97. "Jetliner drops 32,000 feet; 400 aboard; 50 are injured," Associated Press Release, *Huntsville (Alabama) Times*, Feb. 20, 1985, p. 1. Also "China Airlines Pilot Denies Cockpit Error," AP Release, *Huntsville (Alabama) Times*, Feb. 21, 1985, p. A-9.
98. *Asahi Evening News*, Tokyo, Japan, June 22, 1982. Significant airline sighting by Japan Air Lines flights 403 and 421 of a giant, expanding globe of light on June 18, 1982, in the North Pacific, 700 km. east of Kushiro.
99. T. E. Bearden, "Search for a Unified Theory of Electromagnetics and Gravitation: The Russians Got There First and Weaponized It," 1987 (in publication).
100. T. E. Bearden and Andrew Michrowski, Eds., *The Emerging Energy Science*, P.A.C.E., Ottawa, Canada, 1985.

T. E. Bearden  
December, 1987

# INTRODUCTION TO THE FIRST EDITION

Today there are a great many books available on UFO's, paranormal phenomena, and wild science, and one more such book ought to say something quite different if it is to be justified. Accordingly, in this book I have tried to say something quite different, perhaps in some cases too different. And so, to assist the reader's comprehension, I would like to explain something of how the book came about.

For the last fifteen years or so I have been interested in paranormal phenomena to one extent or another. Fifteen years ago I started studying Shotokan karate, and later switched to Yoseikan aikido, a most profound and absorbing martial art. I had already started serious reflection on the nature of perception, and after some years of aikido practice I occasionally began to experience what might be called paranormal perception. For example, occasionally, when violently attacked by several opponents, I would suddenly discover myself standing calmly on the sidelines watching the robot-like figures go through the motions of a play, motions that had already occurred in one kind of reality and that were now simply being repeated. On the rare occasions when I experienced this pure zen state of aikido, the techniques became flawless. In fact, the state was not separable into attacker, defender, and technique — rather a single union of the universe occurred. Unfortunately, although I eventually reached Sandan (third-degree black belt), I never permanently attained the complete aikido oneness state; this does not normally occur until the sixth dan level.

However, the occasional experiencing of this pure unity made a deep impression on me, for such aikido is pure meditation in motion, and only in such a state can the individual grasp the nature of perception. Only when conscious activity has stopped ("mind like a moon on still water") is such awareness possible. For several years I then laboriously developed a theory and interpretation of aikido for Westerners and eventually published it privately.

In 1971, while finishing a Master of Science degree in nuclear engineering at Georgia Tech, I put together a first crude theory of perception, which was published in 1973, many rewrites later. By that time I was already deeply engrossed in the study of paranormal phenomena, and especially unidentified flying objects. I had seen several UFO's (the earliest in 1950), and no longer doubted that the UFO phenomena represented some sort of new reality experienced by a great many people.

The UFO organizations at that time seemed to be in disagreement with each other. For twenty-five years or so almost everyone studying the phenomena had been trying to prove the extraterrestrial hypothesis, i.e., they started with the assumption that UFO phenomena were caused by, say, a group of young stalwarts over on planet X of star Y, getting beered up on a Sunday afternoon, hopping into an old space jalopy, and motoring over to planet Earth to jolly the natives. So they vigorously cataloged the UFO reports that fit the picture, and embarrassedly ignored those that did not. Yet most of the phenomena consisted of strange lights at night, not steel-hulled spaceships. And most of the contactee cases — particu-

larly those involving apparent communication and abduction — were regarded as just too far-out for engineers and scientists to swallow. Almost everyone in the UFO organizations seemed to be convinced that Earth was being visited by spacemen from another planetary culture more advanced than our own, and so the UFO enthusiasts looked for hardware and spaceships, no more and no less.

The tabloids were a mess — filled with sensational nonsense about the purported UFO invasion of earth. Some invasion! If the would-be invaders possessed such an advanced technology, why had they spent twenty-five years flitting around the backside of the country and frightening the rural people, instead of simply landing an expeditionary force and having done with it? It seemed that almost no one was really looking at the phenomena in a totally unbiased manner. When one did so, without especially selecting the data, the strangeness of the data went up by orders of magnitude.

So I decided — rightly or wrongly — not to compete with the catalogers, but to try to come to grips with the possible *science* evidenced by the phenomena. I wanted to examine what kind of science was necessary to describe the phenomena and the mechanisms producing them. It rapidly became obvious that our scientific framework was not adequate to explain these events. In fact, our logical framework was not adequate. So I decided to look for a new scientific framework, knowing that the effort would be long and arduous and might not succeed at all.

All the unexplained phenomena seemed to me to be interconnected; for example, a study of Sasquatch will sooner or later lead to the study of UFO's and thence to the study of the other phenomena. So it appeared that they were all different aspects of the same overall reality. Since that reality most definitely involved the mind as well as matter, it appeared necessary to develop a new science incorporating both mind and matter. And so the search and the gradual accumulation of insight continued.

The trail led directly to the great paradoxes of science, the great unsolved problems of philosophy, and the three laws of logic on which all logical disciplines and sciences are founded. Using my perception theory, it was possible to see through the age-old necessity for the identity of opposites, how opposites could be identified, and when they were identified. Thus a fourth law of logic could be written and the system closed.

Slowly the nature (or, more precisely, a model of the nature) of mind became clearer. In addition, mechanisms for materialization and dematerialization appeared, as well as mechanisms for metal bending, thoughtform materializations (tulpas), and telepathy.

But the international strategic balance also could not be ignored. From my military background, the Soviet military buildup toward an attack capability was apparent as early as 1970-71. Moreover, from my work on the Moray radiant energy device I had discovered what I believed to be the basic theoretical mechanism used by T. Henry Moray to tap the zero point energy of free space. (This mechanism powerfully amplifies virtual state into observable state.) And positive evidence suggested that the Soviets had obtained the secret of how to make the Moray detector tubes. Putting this together with psychotronics produces an astounding weapon capability — and the Soviets must have had such capabilities already on site and others in development.

I looked for evidence of these weapons, and the evidence was there, cleverly — even diabolically — concealed.

When I then realized the *entity* nature of the collective human unconscious, everything fell into place. Suddenly the different major waves of UFO's made very good sense, as did the cattle mutilations, the Soviet buildup, Khrushchev's 1960 statement about fantastic weapons, Brezhnev's 1975 reference to the development of weapons more frightful than man had ever conceived, the long years of microwave radiation of the U.S. Embassy in Moscow, the Legionnaires' disease, etc.

The intelligence community had completely missed the fact that the Soviets had been working on a psychotronic Manhattan Project for thirty years. Not a soul in officialdom would believe that such capability could be achieved by surprise. This is not because of a deep conspiracy of the government (although I believe one of our high intelligence officials may be a Soviet agent, a sort of Penkovskii in reverse, who has been personally responsible for preventing any serious U.S. governmental research into psychotronics and UFO's); rather, it is because of all the personal arrogance, bias, power-seeking, manipulation, and maneuvering that now make up so much of our top managerial base in government.

So I decided to put out the information for all to see. There is still time — but just barely, I think — to build psychotronic defenses and prevent the launching of the Soviet attack. But we must move swiftly if Fer-de-Lance, the Soviet attack plan, is to be frustrated, for the eleventh hour is here.

Moreover, there is a single human problem responsible for all the ills that man causes man, and that problem has a technical resolution that is well within our grasp. I firmly believe that by psychotronics, the minds of all men can be linked into a great supermind having absolute psychokinetic mastery over time and space — literally a godlike being, in whom the collective human unconscious has a collective conscious instead of the four billion fragmented individual personal conscious minds it has at present. The initial psychotronics linkage mechanism is just a tool; after linkage is accomplished and stabilized, such props will not be necessary.

This is my real goal. Even if the U.S.S.R. launches Fer-de-Lance, annihilates NATO and China, and obliterates all Western retaliation with a stunning blow, and even if the collective unconscious then psychokinetically lashes back with the violent destruction of the Eurasian continent, linkage is still the goal and the final resolution. Should the apocalypse come to pass, there will still be time, in the midst of the horrendous collapse of civilization, to gain the final solution.

And it is the final and total solution. All the parables in the Book of Revelation will be realized. The grave literally will give up its dead — for with the overcoming of time and dimensionality, all that ever has been or ever will be, *is*, in one great oneness, allness, Omega, "I am that great I AM."

That is the goal, and it is toward that end that this book is written.

*Please note that a listing of the research and reference works mentioned in the text can be found in the bibliography.*



**PART ONE**

**A SAMPLING OF  
SPECIFIC PARANORMAL  
PHENOMENA**

In this section I show a sampling from the world of the paranormal, including UFO's of various kinds, psychotronics, Loch Ness monsters, Sasquatch, bigfoot, superfoot, psychokinesis, remote viewing, psychic photography, and a host of other phenomena— all explicable by the theories presented in Part Two.

I fervently believe that a theory can be constructed to explain our lives, including all the strange phenomena as well as the more familiar happenings. In this book a serious attempt has been made to point the way by developing what I believe to be the basic concepts, and by showing that a host of phenomena do seem to be consistent with the schema.

Let us hope that science and scientists are not after all dead, and that they will shake the cobwebs from their eyes and set about particularizing a new paradigm of mind and matter. When the top theoreticians and experimentalists wake up and join in the effort, my task will be finished.

## THE VESTIGIA MYSTERY LIGHT EXPERIMENT

Let me start by introducing you to Vestigia, a very fine, relatively new organization that has been formed to study mysterious and unusual phenomena in a scientific manner. This organization, of which I am happy to be a member, is headed by Robert E. Jones and the investigation of the mystery light is spearheaded by James McGrath and Bill Wagner. (The informative *Vestigia Newsletter* is published by the organization. Persons interested in the objective scientific study of unusual phenomena are cordially invited to contact Vestigia at P.O. Box 1183, Perth Amboy, NJ 08861.)

Vestigia's ongoing investigation of a mystery light in Morris County, New Jersey is a classic example of the manner in which mysterious phenomena may be studied in a scientific manner, and it should serve as a model for other investigative groups. Vestigia's experimental work has exemplified careful planning, close teamwork, proper scientific equipment and preparation, and the patience and persistence that are essential when performing fieldwork experiments in the field of unusual phenomena.

I wish to stress in advance that Vestigia does not endorse my own theory of the possible nature of mystery lights; in fact, the organization very properly remains openminded. Also quite properly, they practice scientific conservatism in studying the possible nature of the phenomenon; at the present time they strongly favor the theory of the piezoelectric effect. Substantial evidence for this thesis includes the presence of a known geological fault in the local area, the presence of piezoelectric minerals in the local granite (e.g. thirty percent quartz), close association of the incidence of the phenomenon with subsequent local earth tremors, conditions favoring the accumulation of a surface charge (e.g., metal railroad tracks oriented parallel to the geological fault), and enhancement of the phenomenon under study. And this is exactly how Vestigia is in fact proceeding.

In science, the prevailing world view is not to be dismissed lightly since a great deal of experimental data has been gathered to substantiate it. And a single experiment cannot establish the need to correct that solidly based view, even if the experiment at first appears puzzling and not in accordance with the accepted view. Only after many exhaustive studies have found the world view inadequate, may a

paradigm properly be changed. From a rigorous scientific viewpoint, then, I am saying that this classic experiment is consistent with my own orthorotation theory, but not that the one experiment proves my theory. The experiment at this point is also perfectly consistent with the more conservative hypothesis that the mystery light is due to the piezoelectric effect. Additional different kinds of experiments are required before either theory will hold. For example, in my own theory, the mechanism of orthorotation must be verified elsewhere, and in the piezoelectric theory, the mechanism that spatially separates the effect from the crystalline material where such an effect normally occurs, must be explained and verified by other experiments.

With these precautionary remarks to the reader, let me now describe the beautiful experiment initiated and still being performed by Vestigia. I will then present my own theoretical explanation, again stressing to the reader that it must be treated as a hypothesis at this point.

Mystery lights occur in many locations throughout the United States and Canada. Vestigia has determined over ninety of them to date. They are recurring phenomena and are often seen near some natural or man-made feature such as a stream, hollow, road, railroad track, field, or mountain.

The mystery light under investigation by Vestigia is located along a one-mile stretch of railroad track in Washington Township, Morris County, New Jersey. The light has been seen by hundreds of people at one time or another over the last twenty to forty years. Dr. C. Louis Wiedemann describes it in the *Vestigia Newsletter*: "Appearing at night, it is said to bob or sway from side to side in the manner of a swinging lantern, and when approached it vanishes, sometimes reappearing at a more distant point."

Quoting from the *Vestigia Newsletter*:

The preplanned battery of experiments and observations was conducted on the night of November 20-21, 1976. Three observation posts were established along one mile of railroad track, and these were manned in shifts by small teams of observers who maintained contact with team leaders via portable radio communicators. Communications were monitored and instructions were issued from a command post which was maintained in two vans joined in a T-configuration adjacent to the central observation post (Post 2).

The vans contained electronic equipment valued at \$30,000, which was wired to sensing devices along the railroad tracks. Four thousand feet of silver plated fine copper wire was laid between the rails and attached directly to an amplifier and oscilloscope in one of the vans, to detect variations in electrical frequency and amplitude. Other cables were attached directly to the rails, providing a capacitance test. Other devices included a Geiger counter, thermometers, a methane gas detector, a barometer, a parabolic listening device, a radar unit, an infrared sensor, and a sensitive compass. Personnel at observation posts were equipped with binoculars and cameras. One tripod-mounted camera equipped with infrared sensitive film was located near the rails at Post 2.

James McGrath, a member of Vestigia's executive board, acted as advisor to the team. Team leader was electrical engineer William S. Wagner who was assisted by Jack Mazzuchelli. In all, sixteen persons were actual members of the team, and a total of twenty-one persons participated that night. A number of these were members of the Unexplained Phenomena Club of the County College of Morris, headed by the club's president, Steve Hopler, and vice-president Mary Ann Barron.

Shown here are six of the seven infrared photos of the mystery light which were taken by the Vestigia team. The frames shown are frames two, three, four, six,

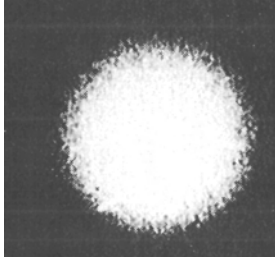

Frame Two

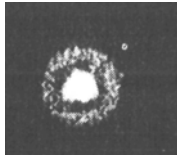

Frame Three

**Photo 1. The Vestigia mystery light experiment.**

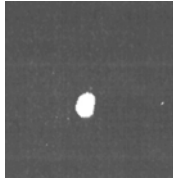

Frame Four

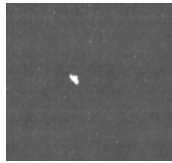

Frame Six

seven, and eight. The camera with infrared film was located at Post 2. Frame 1 was a test frame. Simultaneously with the recording of frame 2 at Post 2, observers looking from Post 1 reported visual observation of a light. The light was not seen by observers at Post 2. A second camera with ordinary film recorded only a pinpoint of visible light.

In the photograph, frame two recorded an image of an apparently plexiform spheroid of dynamic granules of light invisible to the eye of the cameraman. At the same time, observers from Post 1 looking back reported visual observation of a light.

In frame three, within about fifteen seconds the image has decreased in size and the plexiform spheroid is now a thinner corona around a dense, nearly hexagonal center.

In frame four, a dense but small irregular or oval image can now be seen. Frame five, not shown, is quite similar.

In frame six, a substantial decrease in size is apparent.

In frame seven, again the image size has increased, and again it possesses a dome central core surrounded by a thinner spheroidal corona of dynamic granules of light. Also, several separate satellite images are now visible at some distance from the main spheroid.

Frame eight is very similar, except that the satellites are no longer visible and the light in both the core and the corona is not quite as dense.

To describe the experiment precisely, the following passage is taken from Dr. C. Louis Wiedemann's article in *Vestigia Newsletter* No. 2, Spring 1977:

Following several hours of equipment testing and calibration, at 10:21 P.M. two observers at Post 1 radioed the message that they had a "light" under visual observation between their position and Post 2, at an apparent distance of 300 to 400 feet from Post 1. Post 2 observers immediately scanned the area with binoculars and radar, but no object or light was detectable from that position. The yellowish-white light remained visible from Post 1 for approximately one minute and thirty-five seconds, initially approaching the tracks from a lower position off to one side, but soon positioning itself over the rails, and then seeming to sway from side to side in a pendulum-like manner. Its size was estimated between three and six inches in diameter, and for awhile the observers believed it was approaching them. When it vanished, the disappearance was sudden, as if the light had been "switched off."

During the period in which the light was under observation, personnel at Post 2 took pictures of the apparent darkness, and continued to search with radar and binoculars. Two observers at Post 3 briefly saw what appeared to be an orange light between their position and Post 2. While the main light was under observation, several of the instruments in the command post gave unexplained readings. Most notable among these was the oscilloscope's display of an electrical frequency in the range of 40,000 Hertz. Additionally, the capacitance test showed the apparent presence of a conductive body between or over the rails. Nine minutes after the light had vanished from view, the Geiger counter (whose sensor was between Posts 2 and 3) indicated a full scale reading of greater than 5 mr per hour, lasting ten seconds. Normal background radiation was then recorded for five to six minutes (0.1-0.2 mr/hr), whereupon another full scale reading was displayed for approximately seven seconds.

The pictures were enlarged from small images which appeared on the infrared film which was exposed through a 135 mm telephoto lens from Post 2 by Richard Larkin. Film employed was Kodak high speed infrared No. 2481, which is sensitive to infrared radiation to 900 nanometers, with maximum sensitivity from 750 to 840 nanometers. The lens opening was f/3.5 with the apera-

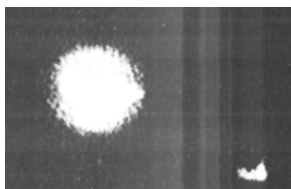

Frame Seven

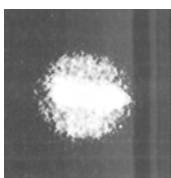

Frame Eight

ture set at infinity. The second frame (frame 2) was exposed between 3 and 5 seconds, and the others were varied in exposure from 3 to 10 seconds. Intervals between exposures were between 10 and 15 seconds.

High speed (non infrared) film in a camera which was hand-held by James McGrath at Post 2 also produced several images of an apparent point source of light above the rails (not shown here). Jack Mazzuchelli observed the area through binoculars during the entire time period, and he was unable to discern any light whatever, although he could perceive the rails and the railbed in the faint illumination provided by starlight shining through a partially overcast sky.

As I stated previously, Vestigia has not yet reached a firm conclusion as to the causative agent, but strongly favors the piezoelectric theory, since it offers the simplest explanation at this point. Again, to quote the *Vestigia Newsletter*:

No absolute conclusions can yet be drawn, other than the apparent fact that a phenomenon or set of phenomena did occur. Team leader Wagner theorizes that the phenomenon might be similar to so-called earthquake lights which have been reported to precede seismic tremors in Japan. Interestingly, there were explosionlike shocks or "loud booms" reported by residents of two housing developments several miles distant from the site on December 5 and 6, 1976, and these shocks were recorded by seismographs at Columbia University and elsewhere. Intensity was (-)0.25 to (+)0.38 on the Richter scale. Wagner postulates a possible piezoelectric effect from tension on subterranean rock deposits.

The possible relationship of a piezoelectric effect will be investigated further. Data gathered in Japan tends to indicate the development of subterranean stresses during the passage of a cold front. In the light of this possibility, it is interesting to note that there was a drop in barometric pressure from 29.9 to 29.76 culminating less than one hour before Vestigia recorded the start of the phenomena. A light snowfall preceded the appearance of the light.

Wagner believes that the initial discoveries tend to indicate that the following conditions must be present for the phenomenon to be manifested:

- (1) A geologic fault in the local area.
- (2) The presence of certain minerals, especially quartz (quartz comprises 30% of the granite in the area under investigation).
- (3) Conditions should permit the accumulation of a surface charge (e.g.: the presence of railroad tracks, because they are metallic).
- (4) The tracks must run parallel to the fault.
- (5) The phenomenon's manifestation tends to occur under temperature changes as well as extreme changes in temperature.

Wagner states, "Our indications are, at this point, that the lights precede earthquakes or tremors."

Regardless of what hypothesis we begin with, it must be consistent with all the major features of the Vestigia mystery light experiment.

(1) The explanation must show why a light with structured patterns formed and changed. The structured patterns changed geometrically in shape and intensity, as well as in movement and location. This dynamic formation and change was recorded on infrared-sensitive film. The geometrical shapes of the light structures must be accounted for.

(2) Ordinary film recorded only a pinpoint source of light.

(3) The light which was photographed in infrared was not seen by the photographer himself, nor by eight other persons who were observing at the time from Post 2.

(4) Either that light or another was seen visually from a different station.

(5) At the same time as the visual appearance of the light, instruments recorded the apparent presence of a conductive body between the rails or over them.



Specifically, the electrical capacitance between the rails was observed to change — or at least indications to that effect were received on the instruments.

(6) Nine minutes after the main light vanished, a Geiger counter began to read full scale for about ten seconds, then lapsed back to background reading. Five or six minutes later, full scale reading was repeated for about fifteen seconds. About a minute after that, full scale reading was again recorded for about seven seconds.

(7) At the same time as the main light visual sighting, an electrical frequency of approximately 40,000 Hertz was recorded on the oscilloscope.

There were also environmental conditions which may well have been involved in the experimental effects.

(8) Barometric pressure dropped from 29.9 to 29.76, culminating less than an hour before the phenomena were recorded.

(9) There was a temperature drop and a light snowfall preceded the appearance of the light.

(10) The geological conditions strongly favored seismic stress and piezoelectric effects. For example, the local granite contains about 30 percent quartz, and there is a known geological fault not far from the experimental site. About fifteen days after the experiment, seismic shocks were indeed recorded at Columbia University and elsewhere, and they were audibly detected by residents of two local housing developments. The measured intensity of the seismic shocks was from (—)0.25 to (+)0.38 on the Richter scale. It thus appears highly probable that seismic stresses existed on the subterranean rocks at the time of the experiment and that piezoelectric activity was present in the local granite quartz due to these stresses.

(11) Conditions also favored the accumulation of surface charge, and the railroad rails (good conductors) were oriented parallel to the geological fault.

(12) Several thousand feet of wiring existed in the immediate area to connect the different stations and the instruments to the sensors. About four thousand feet of fine copper wire, silverplated, was laid between the rails and fed to an amplifier and an oscilloscope to detect variations in electrical frequency. The capacitance test also used cables attached to the railroad rails themselves. The Geiger counter's sensor was also positioned at the experiment's hot spot and wired to the equipment van. Additional equipment and wiring was also used.

Finally, preliminary surveys of the area were carried out by persons of known paranormal sensitivity several days before the main experiment. Before conducting the major experiment, Vestigia interviewed persons who had seen the light and also conducted preliminary site studies using psychics. One nationally known psychic was brought to the site by Vestigia's president Robert Jones, and asked to walk along the tracks. The psychic reported impressions of some personal tragedy, perhaps a gruesome murder. Later several other persons with heightened psychic sensitivity were brought to the site, and they reported psychic impressions.

In all, three psychics were brought to the track. The only directly correctable result was that all three had a reading in the same area on the stretch of track, within sixty feet of the sighting of the night of November 20-21. The psychics' own interpretation of their readings differed considerably.

## **UNEXPLAINED GENERATION OF ELECTRICITY**

Some additional data exist to indicate the generation of electricity by rocks and

the generation of unexplained electromagnetic energy radiated from the earth, ocean, or atmosphere.

For several years T. Townsend Brown has worked in electrogravitics and holds many patents in the field. Some of his laboratory experiments have positively demonstrated a direct connection between electric currents, electric charge, and gravity, although the exact nature of this connection has not yet been fully explained. Nevertheless, it can be shown that highly charged objects do not behave in a gravitational field exactly as predicted by classical theory.

Furthermore, in 1974 Santilli succeeded in proving that one of the classic assumptions of physics is wrong, namely that electric field and gravitational field are mutually exclusive. Santilli proved that gravitational field and electric field are either partially or totally the same thing, in contradiction to present assumptions.

Over a decade ago, Curtis reported the measurement of very low frequency electromagnetic signals generated over the ocean that are not accounted for by any presently known mechanism or theory. Although Curtis published several articles on this effect, no further investigation has appeared in the literature.

Finally, there is a certain location where the generation of an anomalous electromagnetic signal occurs continuously. This is McGregor Missile Range (U.S. Army), where Army units fire air defense missiles such as Nike Hercules and Hawk. As a young captain, in 1961 I headed up the Hawk Evaluation Team at McGregor Range and directed the Hawk missile firing. About sixty-five kilometers out in front of the Hawk missile sites and downrange, there was a most peculiar source of electromagnetic noise, which could considerably affect a Hawk illuminator (continuous wave) radar when the radar antenna was oriented in that direction at a low elevation. In that case the radar would continually noise-lock (make and break lock-on) on the noise signal, dithering slightly as it continued to try to resolve a coherent radar return signal. This noise source was always present, in all seasons and temperatures, and so we simply made each Hawk unit commander and his personnel aware of the phenomenon. On one occasion I even vectored a helicopter with an investigation team to descend on the site and inspect it. All they found was the usual surface of the desert floor, with sparse growths of greasewood and cactus. There was nothing which could serve as a generator or reflector.

At one of our other missile sites in the U.S., there was a strange reflector mechanism located at some distance from the site and at about 15,000 feet altitude. This was rigidly fixed in location and unvarying, and the unit radar personnel often used it to calibrate the range of the radar. They simply locked on the reflecting point and fine-adjusted the radar range dials to indicate exactly the known range to the reflecting point. Here again, personnel on their own initiative vectored an aircraft directly through the point and searched the air in that area, but nothing at all could be found.

## **HYPERFIELD GENERATION OF PHOTON PATTERNS ABOUT A BAR MAGNET COLLECTOR**

The magnetic field has more fundamental components which integrate in the virtual state to form it when two successive orthorotational thresholds (quantum thresholds) are breached. Furthermore, in the picture of a bar magnet taped to the

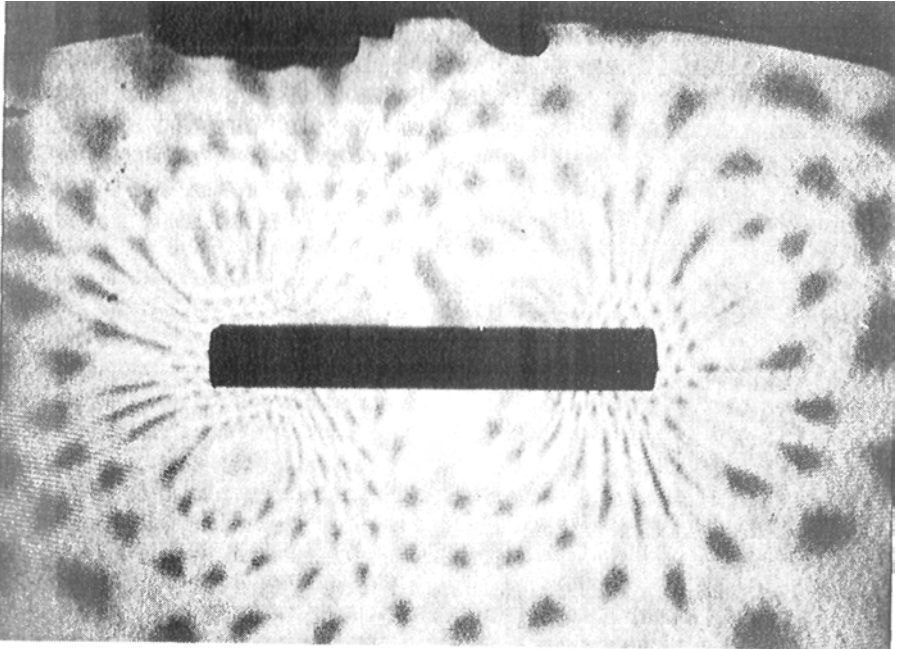

Magnet 3/4" dia. x 6" long taped to face of a color TV tube approximately 1200 Gauss.

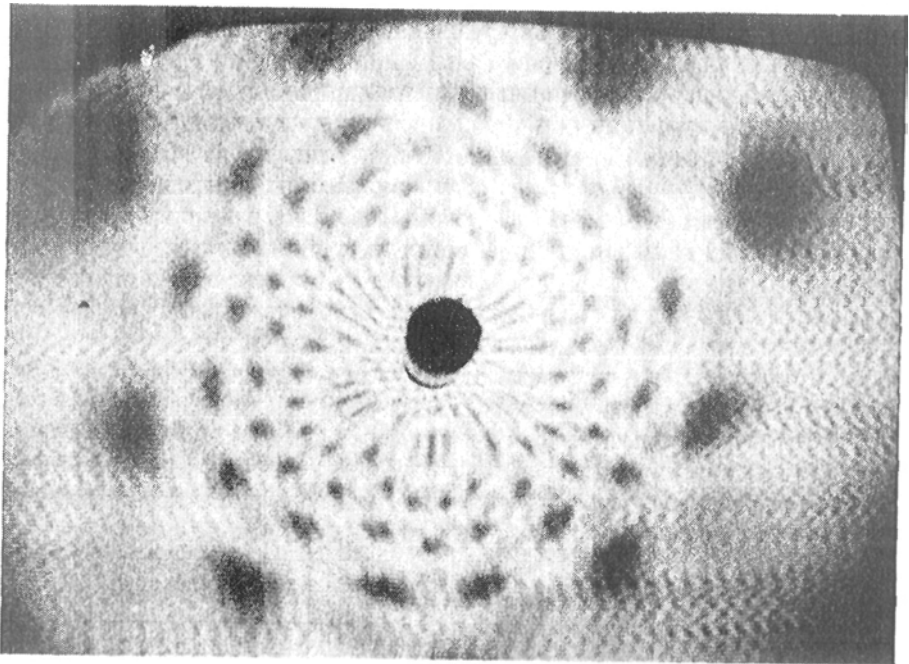

South pole end of same magnet taped to face of color TV tube.

**Photo 2. Hyperfield flux in a magnetic field.**

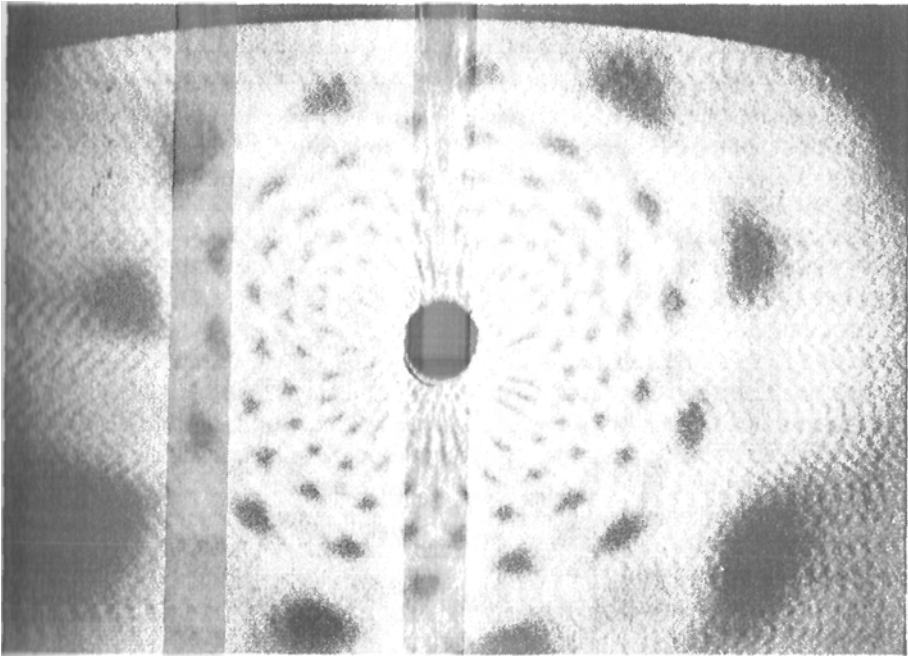

North pole end of same magnet taped to face of color TV tube.

face of a color television tube, one can see that the hyperfield orthogonal circulations in the magnetic field arc not symmetric about the two poles; i.e., the pattern is quite different around the north magnetic pole from that around the south magnetic pole.

Around the north pole, the hyperfield circulation is emitted in the form of a hexagonal solid. Thus there is an intense hexagonal orthorotation about the north pole. Radiating conically out longitudinally is a toroidal null zone, at an angle to the longitudinal axis projected away from the north pole into space. At an even higher angle, another concentric cone is radiated out in the same direction; this higher cone is an emission cone where photons are being generated. Thus viewed from the north end, and at a distance from the magnet, the pattern shown in the right figure of the slide emerges. The pattern is a ring of light or light bubbles, surrounding a concentric ring neutral zone, which in turn surrounds a hexagonal center of intense emission.

If frame three of the Vestigia mystery light photos is examined meticulously, this exact pattern is seen, allowing for the dynamism of the phenomena and for slight nonlinearity of the spatial medium in which the photons are emerging by orthorotation.

On the other hand, looking at the left hand figure on the slide, we see that the outer emission ring is so thin that it has effectively disappeared; it is radiated at right angles to the magnetic longitudinal axle. The middle null area is also much wider. The densely emitting core area now has a relatively circular cross section at a distance. So the pattern of photon emission that is seen from this end is simply a dense round core. Frames four and five of the Vestigia photos demonstrate variations of this effect, viewed at a slight off-axis angle.

When the magnetic field is observed from the side, only the hexagonal dense emission core of the north pole is seen. In the south pole area, we are looking into a large null area, so no emission at all is seen. Frame eight is approaching this result, with a slight deviation from an orthogonal viewing axis. Also, frames seven and eight exhibit composite structuring from several (three or more) side-by-side magnets of square-end configuration, where the magnet cross section is wide, looking at the end. In that case, the top right picture would be elongated, giving a stretched hexagonal dense core surrounded by a concentric null zone of oval shape, further surrounded by a concentric thin emission zone of oval shape. In frames seven and eight, the outer thin emission zone is roughly spherical, not oval. However, a combination (further composite) of the lower right picture case and the upper right picture case could give the pattern exhibited by frames seven and eight.

And as I show clearly elsewhere, orthorotated hyperfield energy usually emerges with a "burst-in" effect which, in free space, assumes a spherical shape. Thus one would expect a dynamically bubbling sphere of light at the initial "burst-in" of the phenomena, and frame two exhibits this effect.

So the expected hyperfield generation of photon patterns about a localized region of magnetic field (such as a bar magnet or composite grouping of bar magnets), when that localized region of field is in the collection or burst-in and decay gradually mode, would account precisely for the particular structured patterns photographed by Vestigia.

Again, this does not prove the hyperfield hypothesis, but shows that the structural patterns obtained are consistent with it.

## **HYPERFIELD CIRCULATION PATTERNS ABOVE A MAGNETIZED RAILROAD TRACK**

Figure 1 shows the hyperfield circulation patterns above a magnetized railroad track. The general setup of the Vestigia experiment is shown. The rails are oriented parallel to the fault line, which means that the rock stresses are oriented perpendicular to the rails. Thus the telluric currents piezoelectrically induced by the quartz and other minerals in the local granite are also generally oriented perpendicular to the rails and below them.

These piezoelectric currents thus constitute effective coils about the rails, magnetizing them weakly along their length, but this is in addition to their normal magnetism, if any, picked up due to the specific local and atmospheric electricity changes.

In the hyperfield flow pattern for two magnets which are lengthwise parallel and viewed from the end, a primary hyperfield circulation pattern exists both between the two rails and in the air above them. The location is the same, whichever end of the parallel magnets one looks into; however, the circulation direction changes with the change of ends. As the strength of the magnetization of the two magnets changes, the vertical distance above the rails to the plane of the center of the hyperfield circulation pattern (primary) changes. The stronger the field, the higher the center of the pattern, and vice versa.

In addition a secondary (weaker) hyperfield circulation area exists over both rails as shown. As the piezoelectric currents fluctuate in direction and intensity, corresponding fluctuations in the magnetization of the two rails occur.

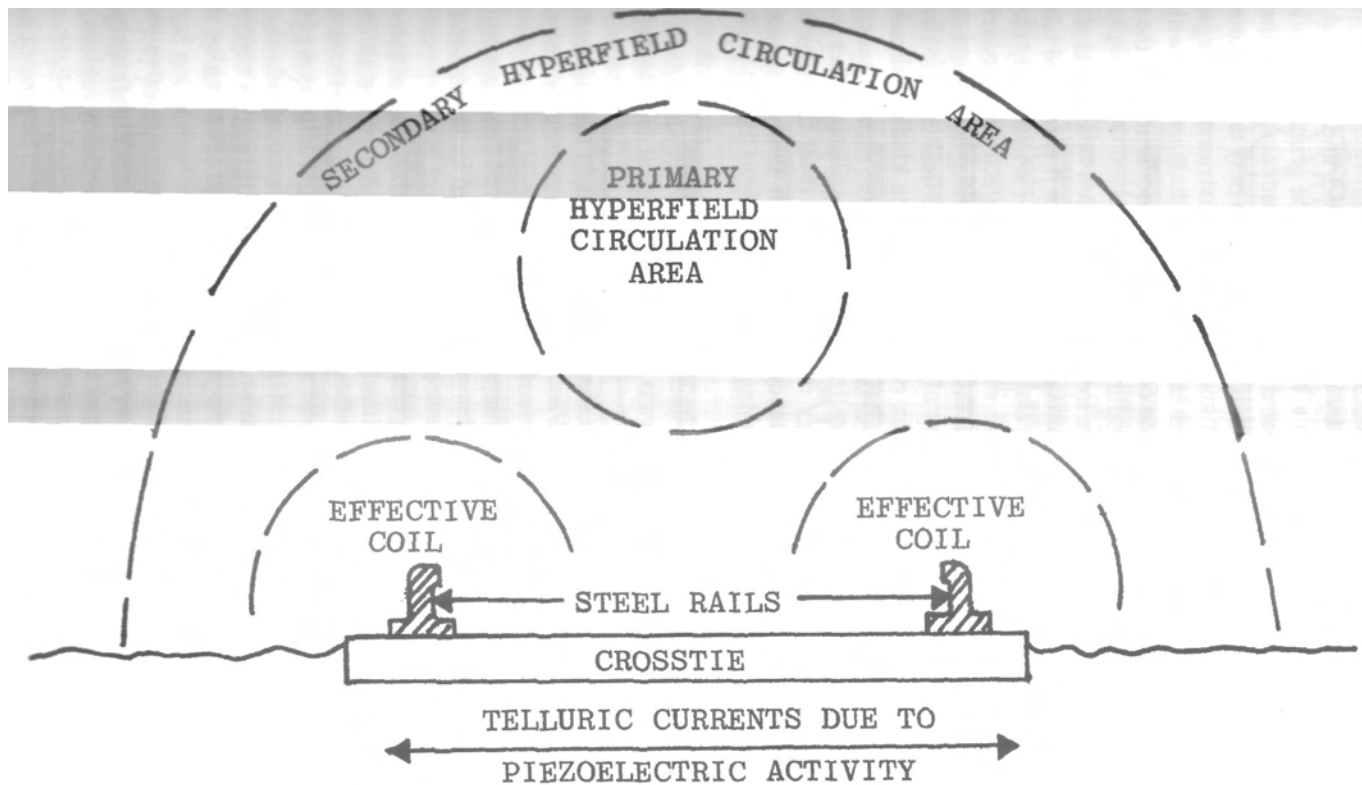

Fig. 1. Hyperfield circulation patterns above a magnetized railroad track

Thus, over the rails there exists a sort of undulating tubular tunnel of primary hyperfield circulation, surrounded by a larger undulating tunnel of half-elliptical cross section. In addition, the terrain and foliage features nearby will have their own hyperfield circulation areas, with flowing currents of hyperfield circulations between them and undulating tunnels over the rails. The final result is a complex flow pattern, which is further modified by atmospheric, ionic, and electrical currents. So a mystery light can kindle into a burst in one of the primary circulation areas and move, usually in a faltering or drift-dart-pause manner, along the undulating tunnels above the railroad track. Structural changes may then be noted as the geometrical aspect between the light and the observer-instrument changes, as additional collection-kindling occurs, and as discharge dampening occurs with the passage of time, due to the discharge time constants of the oscillations of the time dimension itself that are induced by kindling and burst-in.

Note that in the kindling process, the hyperfield circulation in a localized area suddenly bursts into magnetic or electromagnetic field. Since it enters the laboratory frame at right angles, orthogonal relationships result. Furthermore, the appearance of a kindled magnetic field form will change the capacitance between the rails, and a capacitance test will indicate this, as if a conducting body were there. The localized magnet or geometrical piece of electromagnetic field is locked in and maintained as long as the hyperfield flux remains above the kindling threshold. However, since the burst-in of the hyperspatial flux into electromagnetic energy involves the shocking into oscillation of the time channel, an oscillator effect is produced, and electromagnetic signal energy may be radiated from the light form, usually through one of the magic frequency windows which thinly interconnect orthogonal three-spaces. One of these windows is located at about 38,000 to 40,000 Hertz.

Such a signal was indeed recorded in the Vestigia experiment.

Also, at night time the time channel quenching effect of visible light is materially reduced since most visible light is absent. Further, the light-shielded quartz in the underground rocks has two magic windows: one in the infrared and one in the ultraviolet. So the area of the Vestigia experiment constitutes a gigantic kindling mechanism par excellence. With sufficient piezoelectric activity, the collected hyperspatial flux exceeds the kindling threshold required for burst-in, and localized triggering of a discharge or discharges can be initiated in the proper area. The thousands of feet of wire further enhance the collecting and kindling mechanisms. From a physics viewpoint, the living observer is the initiator who initiates the collapse of the wave function, in turn initiating observation. The same ability or property also is required to initiate the kindling of hyperspatial flux into the normal three-space, in my opinion. This is consistent with the rather wide collection of data presented here to show that a living observer can generate or extinguish electrostatic, magnetic, and electromagnetic fields at a distance, even through a superconductive farraday shield. The thought photography examples presented also show that electromagnetic field (light) can sometimes be generated by a living human being, and impress the camera film with the visible light spectrum, even though the light is not consciously seen by the observer's eye. It also appears that frequencies of something other than light, in the infrared and ultraviolet frequency regions, can enter through IR/UV windows and then rotate into the ordinary visible light spectrum and ordinary visible light energy. Such effects also appear to be present in the

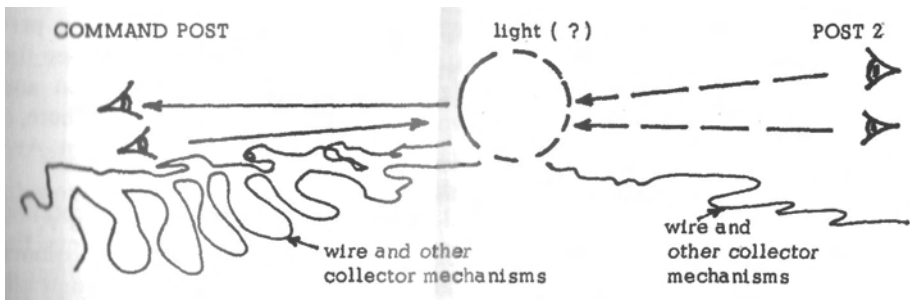

**Fig. 2. The cyborg effect and orthorotational sensitivity**

Vestigia experiment, since the cameraman himself saw no light, but other posts did. Thus an additional directional effect of the rotation into visible light seemed to be involved.

Since so-called thought energy is simply hyperspatial flux which has a minute one-to-one coherence in its crosstalk with the laboratory frame, the section explaining thought photography deals with hyperspatial mechanisms that are also applicable to mystery lights.

## **THE CYBORG EFFECT AND ORTHOROTATIONAL SENSITIVITY**

In Figure 2, I show how it is possible that one team sees the light and a second team does not.

In the inceptive cyborg effect, each person, each instrument, the wiring, other collectors including the sensors, the other paraphernalia of the environment such as railroad tracks, rocks and their minerals, etc. are all cyborged together into a single instrument in the hyperfield domain. This is precisely because the hyperfield domain is the time channel, and all of these exist at the same time. Further, in the experimental locality, the difference in time between observers, equipment, devices, and aspects is small, because the distances between pieces are relatively small. Hence to the hyperfield channel an appreciable degree of coherence exists

between the various components of the hypersensory cyborg. Yet the overall pattern of coherence has high points and lower points in it, and pattern groupings that vary with the grouping of components. Thus the subgrouping at the command post, for example, may be expected to differ in its hyperfield characteristics from the subgrouping at Post 2. Furthermore, the bulk of the collection wiring, and the rails, were outside the command post, so the greatest collection might be expected at this station.

In addition, the human components of the subgroupings vary appreciably in their sensitivity to hyperfields. Some persons are more positive or attuned than others, particularly in their unconscious minds. In fact, some persons are quite negative and are squelchers of the hyperfield effects—the negative psi effect is well known in experimental parapsychology. However, it is reasonable to assume that there were no psi-negatives on the Vestigia experiment; but there was probably an



appreciable variation in the degree of psi-positive exhibition in the various personal unconsciousnesses. So it is understandable that one post may not see the light, while another would. And with the appreciably greater collection and kindling outside the command post, we would expect the sighting to occur there, if anywhere, as long as a real psi-negative was not present in the command post. And the experiment seems to have exhibited this effect as expected.

Also, I must point out that the visual mechanism for detecting orthorotating energy is different from that for detecting normal visible light, unless the orthorotating hyperenergy is extremely strong and overrides the squelch effect of normal light. (At night the degree required to go into visible light is less.) At any rate, the orthorotational hyperfield energy comes in through the infrared and ultraviolet windows for the most part, and then orthorotates into the visible light region, changing its frequency as it is absorbed by or interacts with a receiver.

Further, the orthorotational energy does not travel through three-dimensional space in the accepted sense that a signal normally does; rather, it is entering this three-dimensional space all at once from a region orthogonal to the entire three-space. It is therefore entering all components of the tuning-receiving instantaneously and simultaneously, or holographically, if one extends the term. Each subgrouping component of the cyborg exerts its own tuning-damping constant(s) upon this holographic signal entry, giving differing degrees of receptive sensitivity, or signal strength, or signal to noise ratio.

So the signal enters each part of the cyborg holographically and the reception characteristics of that portion dampen or enhance the degree of orthorotation into the normal electromagnetic field. Further, the actual orthorotation into the electromagnetic field is occurring primarily at the actual sensor.

For a human being, the primary sensors are the retinal surface of the eye and the skin. The retina is actually a complex structured piece of the brain, so to speak, and extensive nervous system complexes are located there which do extensive on-site signal processing. The unconscious mind of the individual directly interacts at the retina with signals received by the retina, either by hyperspatial orthorotation or by ordinary light. So the individual nervous system is highly variable in its interactions with the hyperfield energy that is orthorotating into ordinary electromagnetic energy in the interaction itself. Briefly, the unconscious state of the observer partially shapes and forms the observed.

In a camera, the sensor is the film. It is thus entirely possible for a camera to record light energy that is holographically rotated in from hyperfield energy without the cameraman himself seeing anything at all. This is especially true when the camera film is sensitive to infrared and ultraviolet to an appreciable degree. A camera containing infrared-sensitive film will interact readily with hyperfield energy because it is open in the magic window between orthogonal frames. A camera containing ordinary film, which is less sensitive to infrared, will interact much less in the magic window because it barely extends into it.

Thus, with other variables held constant, one would expect the infrared camera to record hyperfield energy to a much greater degree than the camera containing ordinary film, and indeed the Vestigia experiment has demonstrated this effect.

Furthermore, the experiment exhibited heightened kindling and collection outside the command post due to the distribution of wiring, components, and rails.

## ADDITIONAL FACTORS CONSISTENT WITH THE VESTIGIA EXPERIMENT

First, a cooling effect is often associated with the appearance of paranormal phenomena; this effect is well documented in the literature.

A corollary effect also exists when hyperfield energy is being collected and kindled. Just as lowering the electronic noise in an amplifier increases the fidelity of the signal, lowering the local environmental temperature reduces the "noise" that is blocking the collection and kindling of hyperfield energy. Specifically, reducing the temperature reduces the photon emission and absorption activity of the environment. This lowers the background electromagnetic noise which inhibits orthorotation of the hyperfield energy into electromagnetic field energy. Since photon activity is reduced, the consequent photon squelching of the time channel (precisely detailed elsewhere in this book) is also reduced. This in turn lowers the threshold required for kindling to occur.

Also, a Geiger tube often acts as a collector and amplifier of bioenergy and hyperfield energy. (The association of Geiger counter readings with UFO phenomena has been frequently noted in the literature.)

The Geiger tube may become a detector of hyperfield energy, because the tube's kindling threshold may be significantly lower than that of the environment or of other components such as the observer's eye. Kindling across the Geiger tube's

lower threshold simply creates an electrostatic field inside the gas in the tube. In fact, it is the potential ionic current that is the collector, since hyperfields accumulate along probability paths as well as along observationally determined paths, communicating with both future and past. At any rate, the kindling of an electrostatic field in the Geiger tube may result in ionization of the gas if the field is of sufficient intensity. An avalanche discharge may occur and the Geiger counter may indicate a reading (usually appreciable or full scale). This may occur even though no visual phenomena are seen and even though other sensors receive no indication. This reading of the Geiger counter is of course not due to radioactivity. A Geiger counter *does not indicate radioactivity*; rather it indicates appropriate ionization of its internal gas. In this case, the kindling of hyperfield energy into electrostatic field occurred, generating the ionization in the Geiger tube gas.

Note that this occurred in consonance with the visual sighting and the infrared film photos, and when no visual sighting resulted and photos were not taken.

Furthermore, as I point out elsewhere, the kindling and burst-in of energy has a discharge time constant, due to the discharge time constant of the oscillation of time that occurs at kindling and burst-in. Depending on the initial amplitude of oscillation at burst-in, the time required to lower the burst amplitude to kindling threshold and below varies. When the amplitude drops below the kindling threshold, kindling and burst-in cease and the hyperfield-induced electrostatic field in the Geiger tube vanishes, stopping the hyperfield-induced ionization of the gas in the tube. The Geiger counter reading then drops back to normal background reading.

The variable amplitude at burst-in and the consequent variation in the time required for the Geiger counter to cease reading the hyperfield-induced ionization were demonstrated in the Vestigia experiment. Furthermore, the Geiger counter

showed a reading twice when visual phenomena were not seen and cameras did not record. Of course, no photos were taken during the Geiger counter readings.

Finally, the drop in barometric pressure also lowers the molecular collision activity of the local atmosphere, and lowers the rate of production of collision ions, electric currents, and photons induced by the collision activity. This reduces the electromagnetic noise, which is squelching the collection mechanism and raising the kindling threshold. It reduces the kindling threshold, making orthorotation of hyperfield energy into electromagnetic-electrostatic-magnetic field energy easier.

Thus, according to hyperfield theory, the major features of the Vestigia mystery light experiment are seen to be within normal expectations. Again, this does not prove the hyperfield-orthorotational hypothesis, but it is consistent with it and therefore constitutes an important piece of evidence for the theory.

Also, I should stress that the piezoelectric theory is in fact included in the hyperfield theory, and is a vital part of it. In other words, the hyperfield theory is an extension of the piezoelectric theory, and in my opinion the extension is necessary if the piezoelectric effect is to fit the experimental results. There are no contradictions between the two theories since one is merely an extension of the other.

## REMOTE VIEWING

In a classic series of carefully controlled experiments at SRI International, physicists Hal Puthoff and Russell Targ have shown that the human mind can produce evidence of its ability to see at a distance, and also to anticipate the future.

In their protocol one experimenter goes to a distant target, which is selected randomly for him en route, and a subject in the laboratory tries to describe the target scene, both orally and by sketching on paper. The experimenter in the field uses a random number generator to select one sealed envelope out of a group held by a controller accompanying him. The selected envelope is then opened, and that target becomes the target for the experiment. The targets are preselected with rigorous protocol by a group not involved in the experiment.

In the experiment shown here, the target selected was a rather unusually shaped playground merry-go-round, with handrails made of bent pipes, as shown in the two photographs. The laboratory subject, in addition to describing the scene verbally, made the sketches shown at the right. As can be seen, the channel is noisy, but there is definitely signal in it.

Puthoff and Targ also obtained some of the best experimental results when the laboratory subject was asked to describe the scene which the field team would see in the future, the target selection via random number generator not yet having been made. A wide variety of subjects — including persons hostile to parapsychology — were used by Puthoff and Targ in their experiments, with good results.

Each particle of mass in our bodies represents one closure of the entire universe — yielding a holographic reality — and deeper communication with ourselves is identical to communication with the universe, including any part of it, at any distance. Furthermore, in hyperspace the future and the past are all present. Since a particle does indeed exhibit a four-dimensional component for 1/137 of the time, each particle does connect to the future and to the past. With selective tuning

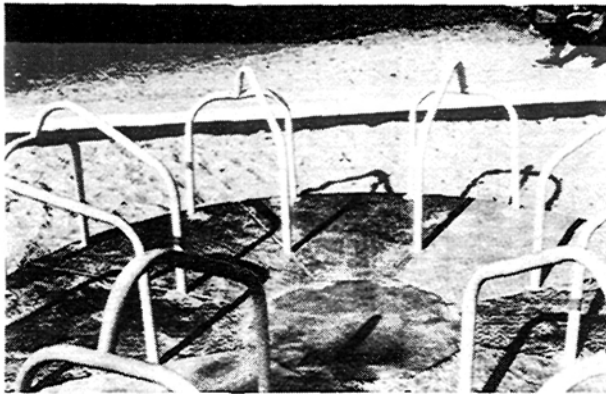
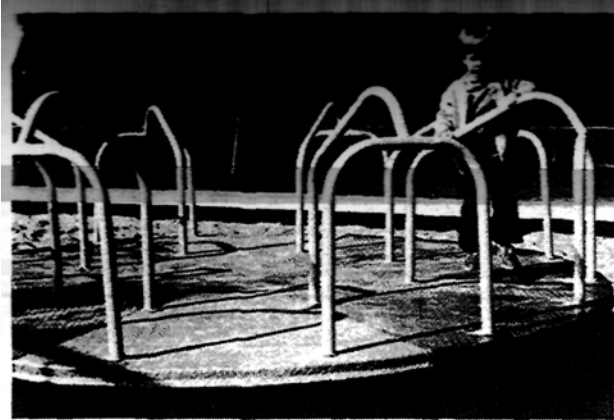

Target: Playground Merry-Go-Round.

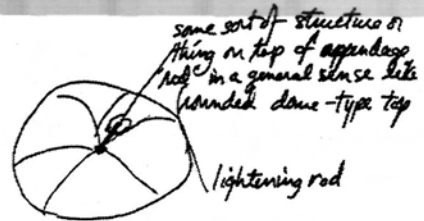

TOP VIEW



Responses.

Photo 3. Remote viewing.

and kindling any part of this holographic reality is accessible. However, because of the smallness of a single selective signal in the midst of the totality, the channel is quite noisy. For this reason skilled psychics ~ persons who have been found to have a greater fidelity of selective tuning - can be expected to produce better results than the normal person.

Puthoff and Targ's results have also been successfully repeated by other experimenters.



T. Henry Moray makes some final adjustments in tuning his radiant energy device to tap zero-point vacuum energy.

## THE MORAY RADIANT ENERGY DEVICE

In the early 1900's, Dr. T. Henry Moray of Salt Lake City produced his first device to tap energy from the metafrequency oscillations of empty space itself. Eventually Moray was able to produce a free energy device weighing sixty pounds and producing 50,000 watts of electricity for several hours. Ironically, although he demonstrated his device repeatedly to scientists and engineers, Moray was unable to obtain funding to develop the device further into a useable power station that would furnish electrical power on a mass scale.

As a boy, Moray had been deeply inspired by the greatest electrical genius of all time, Nikola Tesla. His imagination was especially fired by Tesla's claims to have knowledge of an energy source greater than ordinary electricity, and by Tesla's emphasis on frequencies as the stuff of the universe. When Moray finished high school in Salt Lake City, he went abroad to study, and took resident examinations for his doctorate in electrical engineering from the University of Uppsala, Sweden, during the period 1912—14. Returning home, his diploma and credentials were interrupted by World War I, and the University mailed him these items in 1918 after the war.

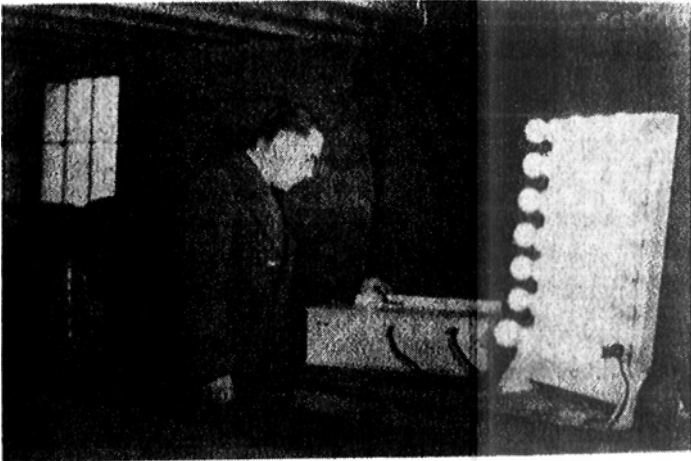

Here **the** Moray radiant energy device is providing free power to 35 100-watt lamps and a 1200-watt Iron.

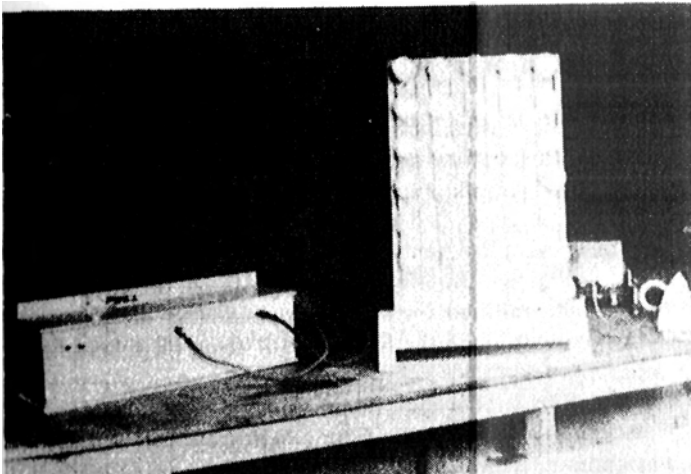

Once tuned in, the power continues and is free for the taking.

Photo 4. The Moray radiant energy device.

Shortly thereafter, Moray produced his first elementary device that delivered measureable electrical power, and he continued to work diligently on energy devices when he had time. In the 1920's and 1930's he steadily improved his devices, particularly his detector tube, the only real secret of the device according to Moray himself. In his book, *The Sea of Energy in Which the Earth Floats*, Moray presents documented evidence that he invented the first transistor-type valve in 1925, far ahead of the officially recognized discovery of the transistor. In his free energy detector tube Moray apparently used, inside the tube itself, a variation of this transistor idea — a small rounded pellet of a mixture of triboluminescent zinc, a semiconductor material, and a radioactive or fissile material. His patent application (for which a patent has never been granted) was filed on July 13, 1931, long before the advent of the Bell Laboratories' transistor.

In test after test Moray demonstrated his radiant energy device to electrical engineering professors, congressmen, dignitaries, and a host of other visitors to his laboratory. Once he even took the device several miles out in the country, away from all power lines, to prove that he was not simply tuning in to energy being clandestinely radiated from some other part of his laboratory. Several times he allowed independent investigators to completely disassemble his device and reassemble it, then reactivate it themselves. In all tests, he was successful in demonstrating that the device could produce energy output without any appreciable energy input. According to exhaustive documentation, no one was ever able to prove that the device was fraudulent or that Moray had not accomplished exactly what he claimed. On the other hand, the records are full of signed statements from physicists, electrical engineers, and scientists who came to the Moray laboratory as doubting Thomases and left with the complete conviction that Moray had indeed succeeded in tapping a universal source of energy that could produce free electrical power.

But in the face of all of this, the U.S. Patent Office refused to grant Moray a patent, first, because his device used a cold cathode in the tubes (the patent examiner asserted it was common knowledge that a heated cathode was necessary to obtain electrons) and, second, because he failed to identify the source of the energy. All sorts of irrelevant patents and devices were also presented as being infringed upon or duplicated by Moray's work. Each of these objections was patiently answered and nullified by Moray; nonetheless, the patent has still not been issued to this day, although the Morays still keep the patent application current.

One of Moray's efforts to develop the machine involved an association with the Rural Electrification Agency for a short time before World War II. At that time, the R.E.A. was apparently infiltrated by Communist sympathizers and high level officials of a decidedly pinkish tinge. These officials continually urged Moray to turn over all details of his device to the Soviet Union, and even arranged the visit of high-level Soviet scientists to the Moray laboratory to see the device in operation. On the initiative of the Communist-infiltrated R.E.A., one person — let us call him "Z" — spent about two months in Moray's laboratory, and succeeded in worming his way into Moray's full confidence. Moray eventually disclosed most of the details of the construction of his special valve to "Z" — the only person in whom Moray ever completely confided.

There is strong reason to believe that "Z" was a Soviet agent, and that this is

where the Soviets first obtained the impetus to develop the hyperspace amplifiers later used in their psychotronic weapons.

However, Moray became quite alarmed at the continued attempts of his R.E.A. contacts to get the device into the hands of the Russians. He eventually concluded that he had become involved with a governmental group filled with radicals and reactionaries. Moray became concerned that fifth column activity was actually directed against him in an attempt to steal his device. Quotes from the *Salt Lake Tribune* of December 2, 1941, attributed to Representative Thomas D. Winter, imply that Moray's suspicions of the R.E.A. were well founded, since Representative Winter called for a full-scale investigation of the R.E.A. on the grounds of Communist infiltration. Indeed, Moray was wounded by gunshot in his own laboratory on March 2, 1940, which seems to suggest that his fears and suspicions were based on fact. Moray severed his association with the R.E.A. in February 1941.

However, his basic unit had been destroyed by a hammerslinging witness in 1939; it is not clear whether or not this was the work of "Z" or of someone else. According to his son, John Moray, the man who broke his unit, as well as other interested groups, wanted complete disclosure of the materials and construction - **nothing** more or less. John Moray, who operates the Research Institute in Salt Lake City, has been trying to continue his father's work since the basic unit was destroyed. Dr. Moray himself died in May 1974.

According to John Moray, highly energetic cosmic rays from space are tapped by the machine, which is in subharmonic resonance with this high-frequency energy level, and it converts this energy level into a usable form of electricity. However, **John** Moray's use of the term "cosmic ray" is not necessarily the same as that of **modern** physics, but in fact is the same as the present concept of "zero-point" energy of vacuum. T. Henry Moray envisioned all space filled with tremendously high frequency vibrations carrying vast and incalculable amounts of pure raw energy. He envisioned the dynamic universe as a turbulent source of great energy, just as the ocean waves carry energy throughout the earth. This was also the vision of Tesla, and after him of Clifford and Einstein, who turned the attention of general relativity to the problem of the nature of the vacuum itself. Clifford and Einstein founded a branch of physics that has come to be known as quantum geometrodynamics, the study of energetic change that occurs in little pieces, including the concept that very small lengths of space, or pure vacuum, themselves oscillate at great frequency and with great energy. In Moray's day relativity was still a strange and unproven branch of physics, suspected and rejected by most of the physicists of the day, and quantum physics was still in the process of being worked out. There was no theory whatsoever predicting that empty space itself not only contained prodigious quantities of energy, but in fact *was* prodigious quantities of energy. But slowly, over the decades, the picture has changed, and the modern followers of quantum geometrodynamics assert the truth of Tesla's original vision. Today we know that one cubic centimeter of pure vacuum contains enough energy to condense into  $10^{80}$ — $10^{120}$  grams of matter! Thus the major part of Moray's thesis — that vacuum itself contains unlimited energy — is vindicated today. In this sense empty space is like a gigantic, restless ocean, and Moray's free energy "tapping" device is no more mysterious than the water wheel. In other words, his **thesis** that the energy is there to be tapped is correct; it only awaits a practical



method to tap it in order to solve the energy problems of mankind forever.

Moray thus is vindicated as a man ahead of his time, who simply built a device before any theory existed to explain its operation. Moray met with constant opposition, and his life and that of his family was anything but pleasant. Certain pressure groups constantly tried to force him into selling for almost nothing, or to disclose the secrets of his valve's construction. He was often attacked and he was sometimes shot at on the city streets. In fact, his life was threatened so often that he was forced to install bulletproof glass in his automobile. His laboratory was broken into, some of his components and papers were stolen, and his dogs were continually being killed. Moray was shot in his own laboratory, and he himself always carried a gun. Because he was harassed ceaselessly, over the years he became understandably suspicious and close-mouthed about his work. He sometimes greeted visitors at his desk with a loaded pistol lying on the desk within easy reach, and occasionally confirmed that he would not hesitate to shoot if he were attacked or threatened. One of his greatest fears was that big interests would take up his invention and simply shelve it to keep it from benefiting the public. When large companies made him offers, he always demanded written guarantees that the device would be put into production and sold to everyone, once it was developed.

Moray also realized the potential of his device as a weapon. He was fully aware that the only difference between a controlled energy device and an explosion is the rate of release of the energy. According to John Moray, his father received an offer to go to Japan in 1938 because he had built a deathray which operated off the device. According to John, a representative of the Japanese government came to the laboratory and offered a position to Moray, but he refused. Allegedly Moray had managed to rig the device so that it projected a ray of energy in a beam, and could kill mice instantly at over fifty feet. When radiated by the beam, the mice were carbonized immediately. They appeared frozen, but nothing was left except their shells, and they simply fell apart when touched.

In one experiment Moray ran his device for 157 hours without any connection to external power sources, and produced over fifty kilowatts of power during the test. He also found that an additional fifty kilowatts could be added by simply providing another tap further back in the circuit. When he shut the device off from this test, he had proven once and for all that the device was generating electrical energy from free and natural sources without batteries or external power. During this test nothing in the machine heated up; instead, all parts of the circuit ran absolutely cold. This alone is totally unexplainable by ordinary electromagnetic theory, and it strongly implies the truth of Moray's assertion that the device simply collects the energy in each of its stages in a subharmonically resonant manner, in synchronization with the extremely high frequency cosmic oscillations. In other words, since the parts of the machine ran cold, it is clear that the energy was being simultaneously collected at each stage rather than being processed through the individual stages in serial order, since serial processing in the conventional electrical sense would lead to resistance heating of the circuit elements.

Moray's device used twenty-nine stages of his special detector valves, which were difficult to produce, costing about five hundred dollars each. Only about one in four proved suitable for operation. He also had difficulty in obtaining sufficiently pure materials to make his special mixture for the pellet that enabled tube operation in a one-way gating fashion. Moray explained that his device was based

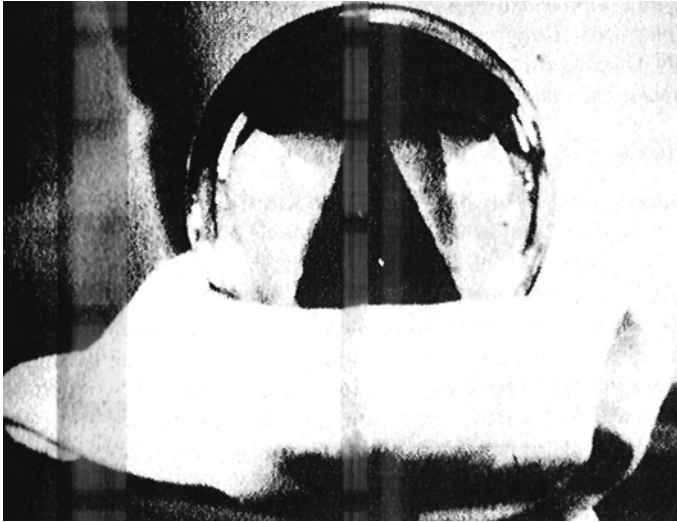

Photo 5. An Atlantean power crystal?

on the discovery of a mixture that would act as a one-way gate for the high frequency oscillations of space, so that the energy could go through the material more readily in one direction than another. Thus it was like a one-way gate valve to an ocean wave; the energy "water" could flow in in each valve, but was prevented from flowing back out. The assemblage of multiple stages thus provided a series of collectors which contained enough energy to be useful. Theoretically there was no limit to the number of collectors that could be added, and so there appeared to be no limit to the energy that such a device could produce.

## **AN ATLANTEAN POWER CRYSTAL?**

The next two photographs are of a most amazing quartz crystal sphere removed from a chamber in a pyramid underneath the surface of the ocean in the Bermuda Triangle. Dr. Ray Brown purportedly removed the object in a dive while treasure-hunting with several friends after a storm had stirred the sandy ocean floor in 1968. Brown describes how he swam into a chamber in the pyramid after swimming around it three times, and how he saw seven stone seats surrounding two handlike stone holders for the crystal in the center of a table or dais, with a two inch metallic rod running down vertically from the roof of the stone chamber and pointing directly at the crystal. Brown plucked the crystal from the holder and ascended to the surface; he found that his companions had brought some nonoperative objects to the surface which appeared to be some sort of strange electrical apparatus.

Brown himself had a strange foreboding and a strong impulse against returning to the site, and so he refused to do so. Three of his companions reportedly returned at a later date, and their boats were found floating abandoned in the Triangle. The three men were never seen again.

The crystal does indeed have some strange properties. In the first picture one can clearly see a very sharply outlined, pyramid shaped inclusion inside the quartz. The pyramidal inclusion is dark, but the crystal is absolutely clear. However, the second photo shows that the quartz is milky when seen from a different angle. Here three pyramids can be seen.

Other objects have been seen and photographed in the crystal from time to time. In *The Pyramid Guide*, Vol. V, No. 4, there is a photograph of the crystal showing a very distinct, humanlike iris and eyelid appearing in it, making it resemble nothing so much as a giant human eye. In that photo the three pyramids are not visible.

While I have not personally investigated the crystal and examined it in detail, some general remarks can be made. (1) Brown reported finding the pyramid after a huge storm had stirred the ocean, including the ocean's sandy bottom. This had revealed outlines on the bottom resembling buildings, which had attracted the attention of the treasure hunters. (2) Such a storm, over the ocean's great water mass, is an excellent kindler of bioenergy. In other words, Brown and his companions were definitely in a place which should have had an enormous kindling of bioenergy from the biosphere and the collective human unconscious. (3) Sufficient publicity has been given the Bermuda Triangle's mysterious disappearances to have its alleged ability to open a window between worlds implanted deeply into the unconsciousnesses of a large number of persons. (4) Brown was with a group of persons who were sharing the same sensations with the storm and surrounding area, so there was sufficient coherence of their personal unconsciousnesses to accomplish at

least some degree of tuning. (5) The legends of Atlantis were in a great revival period in the late 1960's from the popularizing of Edgar Cayce's work and other material, as indeed was the Egypt/pyramid/Atlantis mythology in general.

So conditions were very ripe for a tulpoidal contact (see Part Two) of extensive magnitude — perhaps even to the point of tuning in the ruins and pyramid for a period. Brown also reported sensing an omniscientlike presence, which is symptomatic of many such tulpoidal contacts or materializations.

In such a case, Brown could have actually swum into such a pyramid that had materialized from the collective unconscious — which after all has the psychokinetic power of Uri Geller times ten to the four billionth power or so, and which largely maintains the format of our physical reality in the first place. The collective unconscious has no difficulty in creating even many alternate worlds or materializing and dematerializing entire areas, let alone in producing a single pyramid and a ruined city.

Brown's action in plucking the crystal out of its holder and swimming back to the surface would also have constituted a tuning/kindling which was "returning with the crystal into the normal world" — in which case it could have been tuned into complete stability so that it would endure, rather than fade away as do most tulpoids.

Until we have developed psychotronic instruments to scan the crystal and reveal its true story, we cannot say for certain that any of the above actually happened, and that some sort of delusion or fakery was not involved. The point is, it could have happened just as Brown reported it, in the theory I have constructed in the second part of this book.

Until we free our minds from the present bias that physical reality is always permanent and unchanging, we shall never be able to adequately investigate such phenomena as Brown's strange crystal.

## THE CRYSTAL SKULL

It appears that at least some of the ancient peoples understood certain aspects of psychotronics and even possessed some psychotronic devices.

An example of such a psychotronic device is shown in the next two pictures, reprinted here with the kind permission of Bill Cox, from *The Pyramid Guide*, No. 17, May-June, Vol. III, No. 5.

To quote directly from *The Pyramid Guide*:

**These are two views of the famed crystal skull... completely hand-formed, possibly centuries in the making from a single block of hard quartz crystal. It was recovered from beneath the altar ruins, within the jungle-covered, 7 1/2 acre citadel of the ancient Mayan city of Lubaantu'n by explorer F.A. Mitchell-Hedges in 1927. A several-stories-high pyramid was also found within the citadel complex. The skull, possibly of Atlantean and/or Babylonian origin may have been brought to the Americas by the Phoenicians around 1,000 B.C. Frank Dorland says historical records suggest the skull may have been held in the London inner-sanctum of the Knights Templar prior to the Holy Wars. The high priests probably executed ceremonial magic with the skull; a ribbon-like prism in the cranium acts as a magnifier. Hollow light pipes projecting upward from the base permit light reflections from the eye-sockets. The moveable jaw easily coordinated motion with speech. Lesser quality crystal skulls exhibited in the British and Paris museums, and miniature versions, lack the Mitchell-Hedges skull's brilliant craftsmanship**

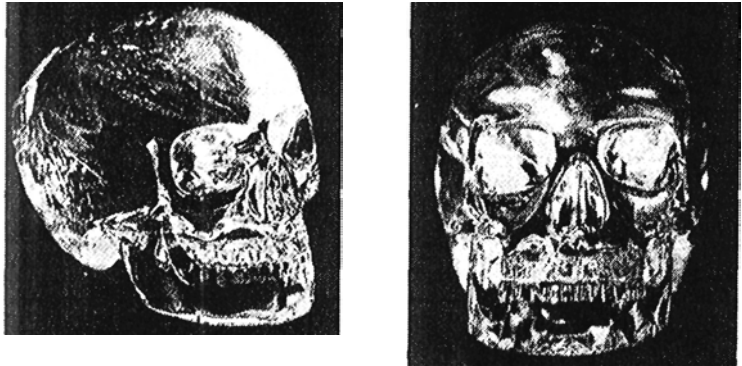

**Photo 6. The crystal skull.**

Two views of the famed crystal skull. Completely hand-formed, possibly centuries in its making from a single block of hard quartz crystal. It was recovered from beneath the altar ruins within the jungle-covered seven-and-a-half acre citadel of the ancient Mayan city of Lubaantu'n by explorer FA. Mitchell-Hedges in 1927. A several-stories-high pyramid was also found within the citadel complex. The skull, possibly of Atlantean and/or Babylonian origin, may have been brought to the Americas by the Phoenicians around 1,000 B.C. The high priests probably executed ceremonial magic with the skull; a ribbon-like prism in the cranium acts as a magnifier. Hollow light pipes projecting upward from the base permit light reflections from the eye sockets. The moveable jaw easily coordinates motion with speech. Lesser quality crystal skulls exhibited in the British and Paris museums, and miniature versions, lack the Mitchell-Hedges skull's brilliant craftsmanship.

One of the major African tribes is also reported to have once possessed such a crystal skull as a holy object and the center of their religion. Their skull was reportedly stolen by a white thief in the early 1800's,

So let us now discuss sonic of the peculiar properties of such a device.

First, quartz is a very hard substance and not easily worked at all. Making such a perfectly carved piece, with removable hinged jaw and eye lenses, must have consumed a tremendous amount of manual labor and considerable time, even centuries. Such an effort is not lightly undertaken; usually there is an overpowering reason for such persistence. In this case, there may well have been such a reason, and ancient priests may well have known it.

Quartz has magic qualities from a psychotronic point of view. It is open to both the ultraviolet and the infrared, and so it possesses two magic windows into the hyperframes, bioframes, orthogonal frames, and other realities. Since the third and higher bioframes (orthoworlds) are all mind worlds, quartz has open magic windows into the mind and mind energies. Thus Frank Dorland surmises correctly that the device can amplify and focus mental energies.

Furthermore, quartz is a piezoelectric crystal. Being crystalline, it possesses a lattice, a regular array of molecular stages. Thus it possesses a large number of identical stages, which is important for hyperchannel amplification.

Properly shielded against visible light, or in dim light, the crystal skull thus can function as a mental amplifier in the hands of a skilled user. Also, the quartz is piezoelectric; multistaged electrical piezoelectric currents are natural hyperenergy-hyperfield collectors, and under the proper conditions the quartz can produce heat and light, since collected hyperfield energy can be orthorotated into electromagnetic field by kindling. It can even produce these effects at a distance due to the hyperchannel circulation patterns surrounding a magnetic field or a localized area of magnetic field. The easiest place to produce effects with the skull would be inside another human head (in the brain).

So, in the hands of a skilled practitioner, the skull is (1) a collector of bioenergy, capable of turning this into electromagnetic energy and physical effects, (2) a form resonance inductor, i.e., a sort of super witness which matches the general shape of the human skull and is capable of resonating with a human skull (and thus with its contained brain) at a distance through hyperspace, and (3) a psychotronic device capable of producing psychotronic effects such as the augmentation of healing energy, psychic attack, telepathy, clairvoyance, precognition, and psychokinesis, where these initiative abilities are possessed by the user or practitioner.

Thus, in the hands of an adept, the crystal skull is indeed a formidable device, and one can well understand how the motivation existed to make it, even though its production may have taken centuries. Since in the ancient days knowledge was zealously guarded and usually incorporated directly into religion, such psychotronic artifacts as the crystal skull would have been regarded as the most powerful, hence the most sacred, of objects. One can therefore speculate that the elite of the elite of the priesthood were the only ones who knew of and were taught how to use the skull, and that this information was guarded extremely closely. The legend of such a skull existing as a central part of the religious magic of an African tribe is not beyond belief. Ordinary crystal balls, which are certainly made more easily, may have originated from the secret rites connected with the skull. An ordinary good quality, clear quartz crystal may well have been the substitute for priests who did not belong to the supreme inner circle, or the device used when a skull was not available.

I have seen at least one picture of an optical image which spontaneously formed in the crystal skull; the image closely resembled that of the Mayan astronomical

observatory at Chichen Itza.

To give a simple example of how the skull may have been used by a skilled priest, let us suppose the priest had an enemy he wished to disable or kill. With the proper psychic exercises he could have induced an increase in his own psychic energy. Then, using the crystal skull, he could simply have visualized the image of his enemy's face, and visualized the energy or light pouring into his enemy's head. The stability of the imagery is more important than effort of will.

At any rate, steady application of this imagery starts the bioenergy projection into the enemy's head and brain, and it collects there. Collection to the kindling threshold starts turning the bioenergy into electromagnetic field. At this point, a host of effects could be produced, depending upon the specific wish and induction by the priest. The effects include sharp pain (such as migraine headache); a leaden mass or frozen mind in which the brain activity itself is slowly frozen and stopped; the generation of a strong, overpowering emotion such as rage, hatred, panic, or terrible sadness; a sharp attack on the mind itself, as if a saw or knife were slashing a physical object to bits; numbness of the body or selected portions of it; interruption of the heart's functioning; kindling of the brain and nervous system into seizures, convulsions, or violent muscular spasms (capable of breaking bones); and an increase in blood pressure until the vessels swell and burst. In the hands of a priest who was strong in psychokinetic ability, this amplified ability would have been projected through hyperspace to the unfortunate victim's vicinity; objects such as stones could suddenly have levitated and hurled themselves at him, bushes and small trees could have enveloped him, etc. All in all, the skull can be used as a terrible weapon.

A few of these effects, and others I have not described, are presently in use by certain lunatic fringe groups in the United States; they use basic devices other than a crystal skull. I have been subjected to several strong attacks, and can vouch for their effectiveness if the target person is unskilled in shielding himself or evading such attack. In two cases I was nearly killed, and in a third case in substantial jeopardy.

Use of the crystal skull by a group of priests would give even more power, for from such a group the kindling level at which bioenergy orthorotates into electromagnetic field energy is much more easily approached. The inceptive power is of course usable for either good or evil purposes. Good purposes would include amplifying psychic healing; curing fevers and other infections; stopping internal bleeding; dematerializing growths and tumors; placing a person into deep anesthetic sleep so that a surgical operation can be performed; treating soil, seeds, or plants to assist sprouting and growth; treating emotional disorders with cancellation thought forms (contrary forms), and projecting them directly onto the unconscious to neutralize the disturbing form; and communicating telepathically at a distance.

A 300-year fabrication period is more credible if we recognize that the quartz crystal would have been usable from the beginning, just as is a crystal ball. So the high priests could have used the rare clear crystal (the skull is made from a single crystal), while priests recently initiated into the level that knew of crystal devices worked on it when it was not needed for use. Such a practice would explain why other skulls less finely worked have been found; these had simply not been as highly finished as the Mitchell-Hedges skull.

Furthermore, cutting off an enemy's head and exhibiting the skull was a common practice among many primitive tribes as a way of showing power. Crystal devices could have been used as a means of combining psychotronic effects with prevailing religious practice and beliefs. The fact that this eventually yielded a psychotronic amplifier of great power in the hands of a skilled priest would have led to the zealous guarding of the knowledge and the device from all but a very few of the elite.

## METAL BENDING

The next remarkable sequence of photos from a Super 8 movie film taken by James Bolen, editor and publisher of *Psychic* (now *New Realities*) magazine, shows Israeli Uri Geller breaking a dinner fork in two through mind over matter. The fork, which Bolen personally verified as being intact before the demonstration, gradually becomes pliable at its midsection as Geller rolls his thumb and index finger over it. The fork finally breaks apart, the prong part clinging slightly to the handle just before it drops away, suggesting that the stainless steel momentarily became plasticlike.

Here the kindling is taking place in the nuclei of the metal atoms and also along the lines of field force in the bonding lattice. The protons in the nuclei may become quarklike due to partial extinguishing of the pions which create their electrical charges. The softening of the electrical field directly softens the ability to hold electrons and rearranges electron orbits. In addition, kindling is occurring in the orbital electrons, partially extinguishing their charge also. The overall effect is for the metal to become plasticlike as lattice bonds are severely weakened. For a metal break due to these effects, the metal in and near the fracture should show the results of severe electromagnetic fields at the localized level, e.g., as if subjected to intense heat from an internal laser action. This has indeed been found to be the case in other experiments, notably by Byrd and Franklin.

## THOUGHT PHOTOGRAPHY: STELLA LANSING

Stella V. Lansing is a remarkable person who has captured a large number of authentic thought photographs on film, and in whose presence others often get thought photographs when they operate their own cameras. For several years her work has been investigated by the psychiatrist and noted researcher, Dr. Berthold Schwarz, who has published numerous papers in scientific journals on his studies of Mrs. Lansing. The late J. Dunninger also observed Mrs. Lansing's work and concluded that it was genuine, and that no magician could accomplish by sleight of hand or other trickery the remarkable results she obtained.

In Stella Lansing's photographs all the evidences and signatures of tulpoidal or thought energy kindling into the first biofield, electromagnetic energy (light), are seen (see Part Two). Typical, metallic-looking, clamshell, UFO-like images are often obtained, most often with several objects arranged in a clocklike circle symbolically: the unconscious may well be aware that the time channel is the paranormal channel, and symbolically express this in a clockwork pattern suggestive of time.



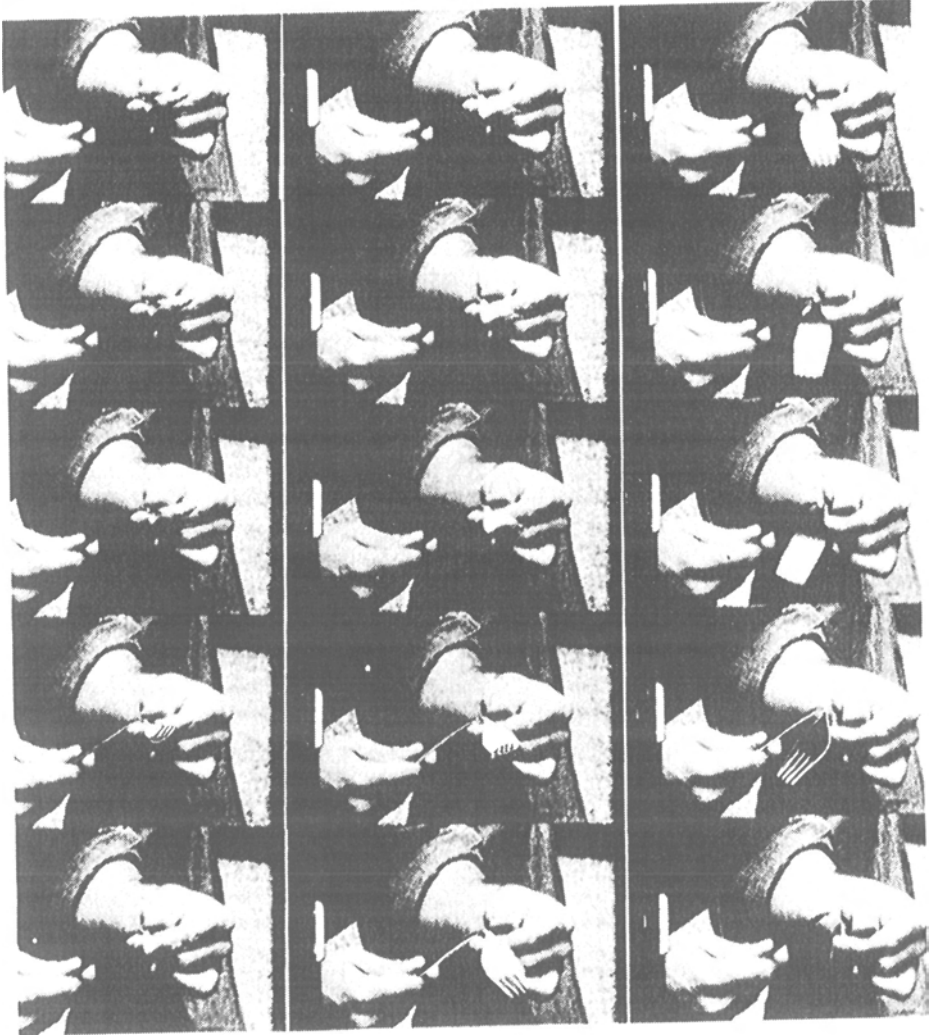

**Photo 7. Metal bending.**



Late evening clockwork pattern of "clamshell-like objects" obtained when photographing a church steeple.



First daytime clockwork pattern, Route 47, Amherst, Mass., September 1972.

**Photo 8. Clockwork patterns.**

Just as Geller and Kulagina have been noted to transfer psychokinetic ability to other talented persons who were in their presence for a period of time, Mrs. Lansing's clockwork patterns and psychokinetic abilities appear to have stimulated another person's abilities in similar fashion. Paul Koslouski is a researcher who worked with Mrs. Lansing for a short time, and in his own thought photographs the clockwork pattern so characteristic of Mrs. Lansing's pioneering efforts dutifully appeared.

Mrs. Lansing is a brave and gracious lady, and her significant work with thought photographs is important to the understanding and advancement of parapsychological science.

## THE DISPLACEMENT EFFECT

The next picture was taken about 1938 in Chicago with a camera on a tripod and a timed release. It was taken by Paul Trovillo, who is the gentleman sitting on the bench with somewhat of a problem of transparency and partial disappearance.

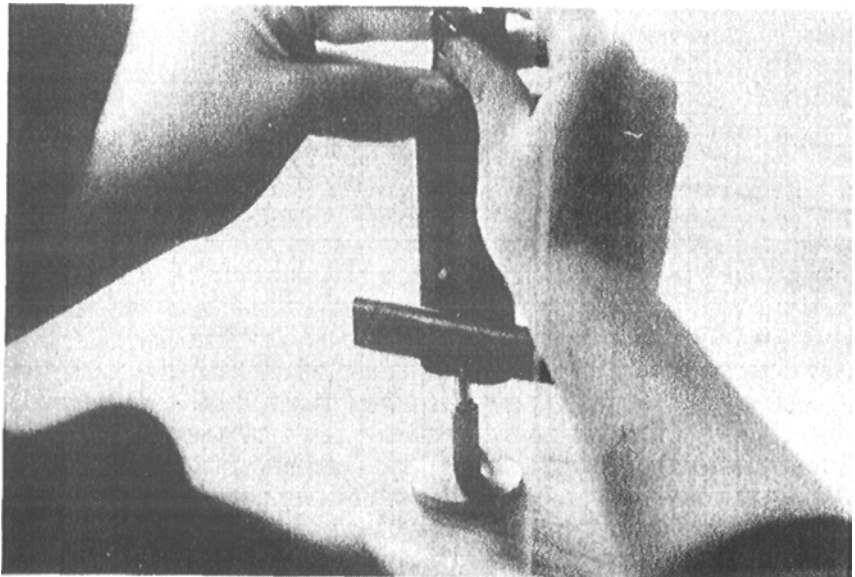

Photo 9. Displacement effect.

The light is by an overhead arc light, which is rich in ultraviolet (one of the magic window frequency bands in the hyperchannel crosswalk between orthogonal worlds). Pan film was used in the camera, and the picture is of Paul and Ferne Trovillo. Note the bushes through Paul's left shoulder and through the slats of the bench at approximately Paul's waist. Also note that the background is in excellent focus.



1. Robert Pavlita, Czechoslovakian engineer, and his daughter.



2. Device becomes a psychoenergetic "magnet" when charged by the human being—and will pick up materials, including nonmagnetic objects.

**Photo 10. Pavlita's psychotronic generators.**

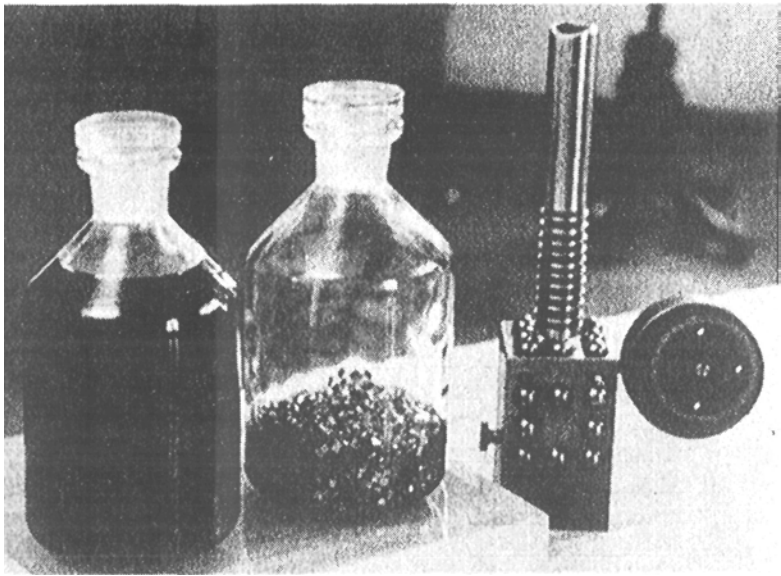

3. A generator that can precipitate solutes from solution. The jar to the left contains a dense solution; when the generator was placed over identical solution in the jar to the right, the precipitate shown in the jar resulted.

Occasionally the kindling of bioenergy (which is greatly eased in ultraviolet light) leads to eddies of hyperchannel connections between separated portions of the ordinary frame. The normal three-dimensional frame is constructed action quantum by action quantum, and each quantum is fissioned and fused individually to give individual increments or jumps of time and length. Appreciable kindling intermixed in the frame construction can provide other geometrical paths for light, so that the light rays during one or more segments of their straight-line path arc actually flipped into and back out of hyperspace. In cases such as this, one can often see right through a physical object, or even inside it (see Part Two).

I have worked with a psychic group in the American Association of Meta-Science, and have seen one experiment where similar effects were obtained, with the camera on a tripod, in a picture taken by my wife.

Excellent pictures of the Loch Ness monster were recently taken by Doc Shiels. These pictures have been subjected to computer analysis by Ground Saucer Watch (GSW) - and GSW was alarmed at the discovery that the monster in the portrait exhibited transparency. Indeed, for a materialization less than complete, which the monster must be if it is to keep disappearing, one would expect or even demand such transparency, even though a large body of water is a good collector for kindling of bioenergy and tulpoidal forms (UFO's are also notoriously connected with rivers, lakes, and the ocean).

Note also that the Dennis Billings UFO picture demonstrates the same sort of partial transparency. There is a readily understood physics that applies to these effects, but the effects are not contained in the present monocular interpretation of physics and reality.

# PAVLITA'S PSYCHOTRONIC GENERATORS

In Czechoslovakia an engineer named Robert Pavlita has been building and demonstrating psychotronic generators for about thirty years. These are devices of various shapes and sizes and composed of materials such as steel, iron, brass, and copper, and they often contain mysterious symmetries of pattern, holes, and shape. The devices for the most part charge up with thought energy when subjected to human contact or eye contact, and then perform various functions such as precipitating a solution, turning, picking up or magnetizing nonmagnetic materials, and killing insects. The devices thus accomplish orthorotation and kindling of thought energy. Pavlita has admitted that his devices could be scaled up to serve as weapons — unfortunately, every tool can be used for either good or evil. He has demonstrated a great many times the killing of insects by pointing a charged rod at them. He also admitted that in an accident his daughter became semiparalyzed and her life was in grave danger, requiring him to work feverishly without stopping for about two days to build a second device to reverse the effects of the first. Pavlita has also demonstrated that his psychotronic devices can either stimulate or retard plant growth, depending on which polarity the plant is exposed to.

The loose information net of which I am a part has recently learned that Pavlita is now in charge of a secret project that has succeeded in building two weapons, one of about two hundred miles range and the other of unlimited range. No further details on the weapons are available.

Pavlita is a pioneering genius, and it is to be hoped that he will eventually release the secret of his psychotronic devices to the world for use in the healing arts and other beneficial sciences. Bioenergy/hyperenergy is real, and Pavlita has scored a major breakthrough in building simple devices to harness it.

## CELL-LIKE INVISIBLE TULPOIDAL FORMS

Trevor James Constable has succeeded in evoking and capturing many of these forms on film. The first photo was taken by Constable on 25 August, 1957 in the Mojave Desert, and shows an amoebalike or cell-like bioplasmic form containing shapes that resemble nucleoli, vacuoles, and other cellular structures. The invisible object was at first directly overhead, but moved to positions that enabled inclusion of local terrain in the pictures.

In material presented in Part Two of this book, I show that all that a physical form or physical body is is a total tulpoid, *i.e.*, a form that can be shown to exist in each and every mind. All that a living biosystem is is a one-to-one coherence established between such a total tulpoid (physical form) and a monocular tulpoidal universe (mind world or hyperframe). Furthermore, all possibilities exist concretely in the various hyperworlds. Thus Constable's plasma creatures do indeed exist concretely—but in invisible, orthorotated hyperworlds (mind worlds). The revolutionary discovery by Constable has been a direct, straightforward way to evoke and photograph such bioplasmic tulpoidal forms. His experimental work is of absolutely fundamental importance, and I would not hesitate to compare its ramifications to those of the Michelson-Morley experiments.

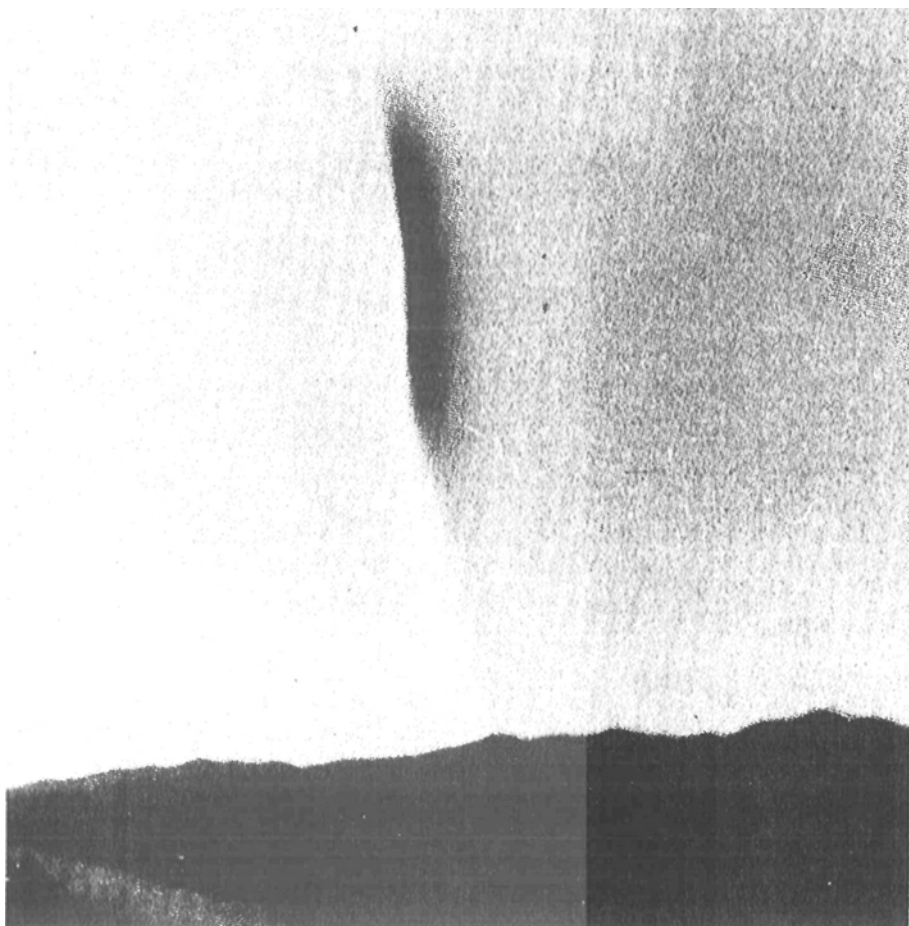

**Photo 12. Form for potential materialization.**

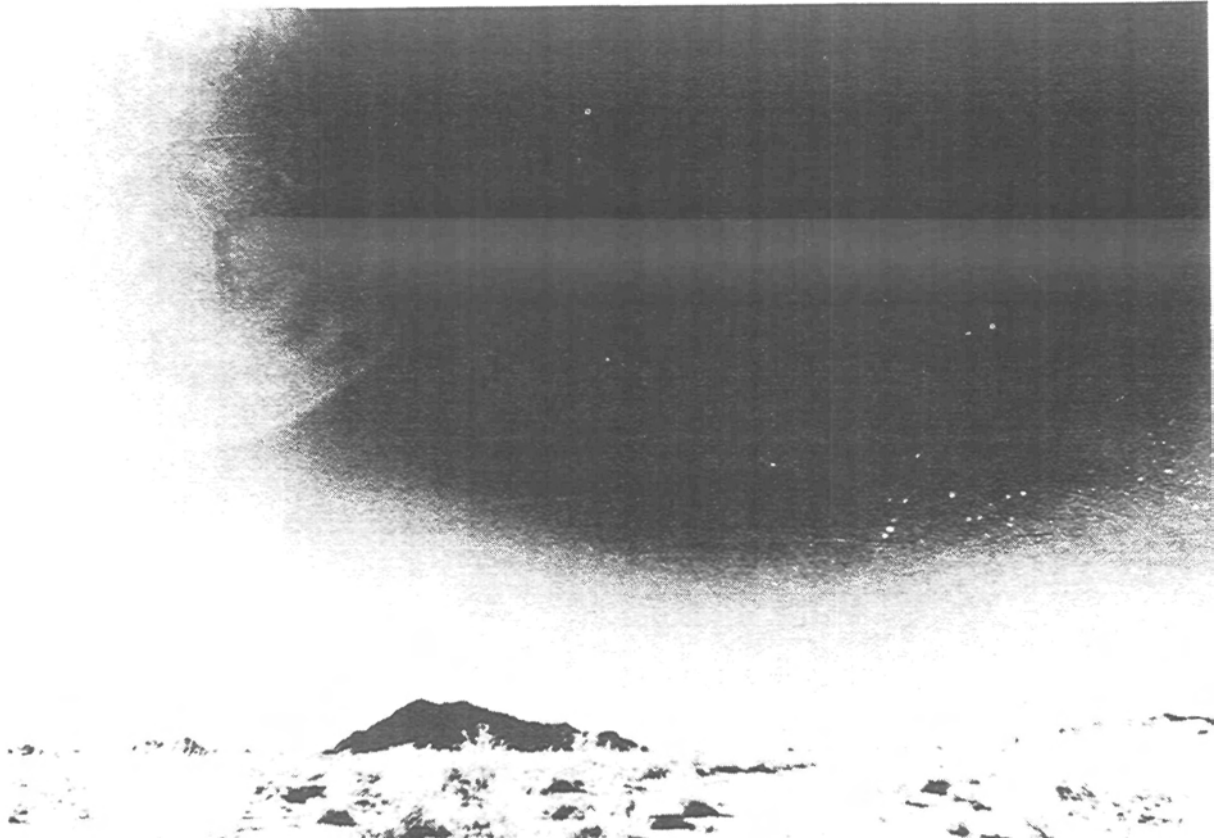

Photo 11. Cell-like invisible tuipoidai forms.



These experiments are also directly related to the work of Miller and Fox, who have shown that, when the probable atmospheric conditions of the earth of millions of years ago are exposed to electrical discharges and ultraviolet radiations, amino acids are formed; and then these proteinoids will form microspheres having cellular characteristics, even the ability to grow and reproduce. Every possible life form is already present in virtual state reality, and under proper selective conditions can be kindled into the first bioframe (electromagnetic field) and photographed, or even into the zeroth bioframe (full materialization).

In the UFO photographed in strong potential condition for materialization by Trevor James Constable, note the form of a disc on edge, only a portion of its form being tangible even to infrared. Note also the whitish lobe of the tulpoidal force field extending earthward from the discoidal region. Highspeed infrared film was used, no filter, shot just before sunrise near Giant Rock, California. Constable's pioneering work is remarkable laboratory evidence for orthorotation and materialization of tulpoidal energy forms.

## UFO'S

The following pages show some of the most extraordinary UFO sightings and other paranormal phenomena of recent years. Photograph 13 shows a noiseless UFO seen by a university student near Las Cruces, New Mexico, in 1967. (The student reported that, as he changed plates in his camera, the object disappeared. He had been taking photos of rock formations for a class in geology.) In the Spring of 1950, two photographs of a highly materialized UFO were taken by Paul Trent on his farm outside McMinnville, Oregon. The first photo (photo 14) showed the UFO at an angle, while the second (not shown) caught the UFO in direct profile.

### 1. Black Ring UFO

From Project Bluebook, here is an example of a tulpoidal UFO moving along through the sky and exhibiting the "black ring" effect. In this case only the edge frame is visible, and that edge is generating the black ring or "light quenching" effect. Note that the inside portion of the tulpoid is quite transparent, for one can see the clouds behind it clearly.

### 2. Anchor Patterns

One of the interesting aspects of combined orthorotation into our normal three-dimensional space and out of it from hyperspace is an anchorlike pattern, shown in the next four pictures. Photo 1 was taken by Ira Maxey, and it shows several tulpoidal forms, which are intersecting our frame in a white or photon-emitting anchorlike pattern. The curved part of the anchor pattern is due to the spinning or orthogonal rotation, and the shaft portion intersects it at right angles. Note also the clouds, whose water content is highly conducive to kindling of the tulpoid — into the first bioframe, in this case.

The second photo from Project Bluebook shows another anchorlike tulpoid — this time the orthorotation is reversed, giving photon absorption — moving through the sky over a dock area by the water.

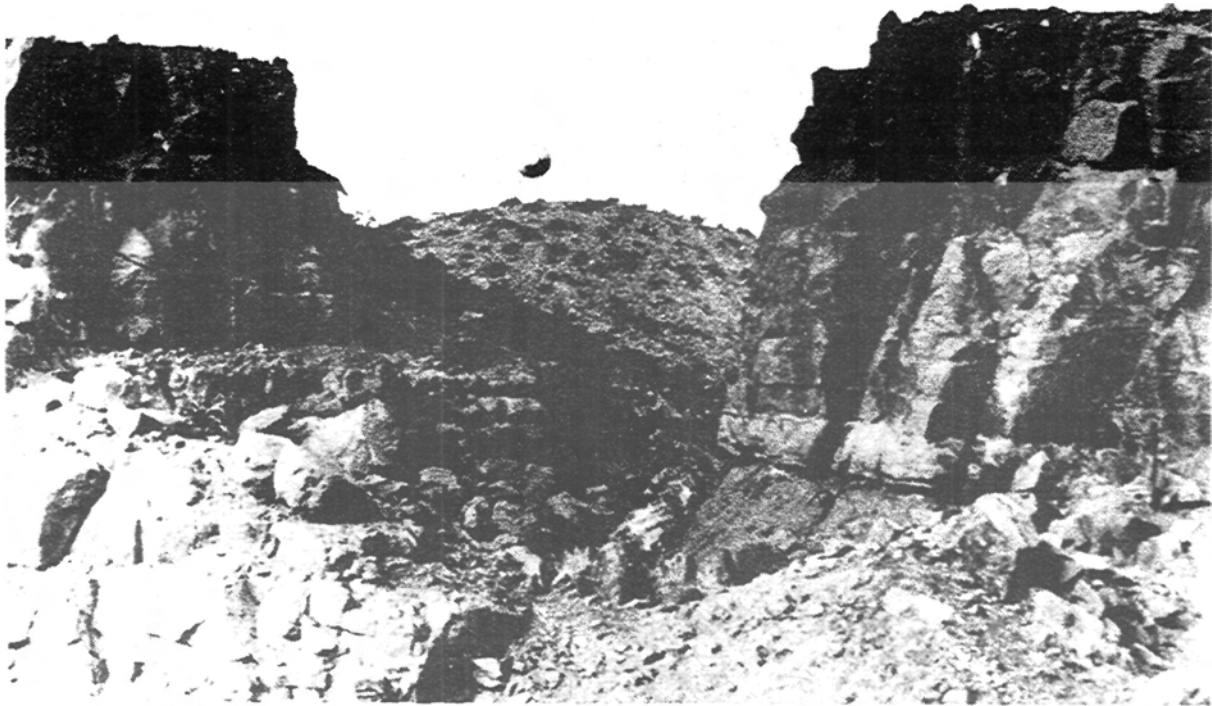

Photo 13. New Mexico UFO.

The third photo, taken in Wales, is one of several which clearly captured another anchorlike tulpoid in a photo-emitting mode.

The fourth photo, taken by Fay Clark in a darkened room, shows very similar photonic patterns being emitted by Ingo Swann's hands after Swann was asked to try to produce energy to be photographed. In the rightmost arc the shaftlike perpendicular bisector can be seen, associated with Ingo's arm. Bioenergy and mind-energy are the same, whether being emitted from a single human system/mind or from a collective system/mind.

### **3. Bifringement**

Another common effect demonstrated by UFO's is bifringement, clearly shown in this photo from Project Bluebook. Here a UFO in highly materialized form is shown just beginning to turn back into hyperdimensional space. Interestingly enough, in hyperspace a tulpoidal form can turn in two or more directions at once, and this one appears to be doing so. A photon-absorbing turn is indicated by the outer bifringement ring, which is white. These can also be compared to photon interference patterns commonly demonstrated by light waves from two or more sources. Just as there are interference patterns in our three-dimensional space, there are interference patterns in higher dimensional spaces. The three-dimensional intersection in our frame of one of these higher dimensional interference patterns may be black, white, or consist of both black and white components.

### **4. UFO's in Water**

Water is a substance that changes its state and form in a fantastic complex and is therefore one of the very best collectors for bioenergy or tulpoidal energy. That is, in fact, why water is so universally associated with living biosystems, for biosystems need a good collective medium in which to establish coherent tuning. So it is not accidental that water is necessary to life as we know it, or that our bodies are largely made up of water. For the same reason (ease of kindling), UFO's and many other tulpoidal forms have a high degree of association with water. Nessie and other water monsters tune in from time to time in large bodies of water such as lakes, rivers, and oceans.

This photo from Project Bluebook shows a UFO tulpoid in the first bioframe (photonic) moving along in the water.

### **5. UFO's in Clouds**

Again from Project Bluebook here is a picture of a UFO tulpoid kindling in water, this time in the moisture in clouds. Clouds are also usually electrically charged, which enhances the tuning effect, particularly when the clouds are darkening and so are highly charged and also densely loaded with moisture. The darker clouds shield out more of the visible light, reducing the hyperchannel (time) squelching effect of visible light.

### **6. UFO Seen by the Author**

The next UFO is one of several seen by me, and it provided a very curious, anomalous phenomenon in my memory. Furthermore, this UFO was sighted by hundreds of persons over a four-state area, so there is no question that something was there in the upper atmosphere.

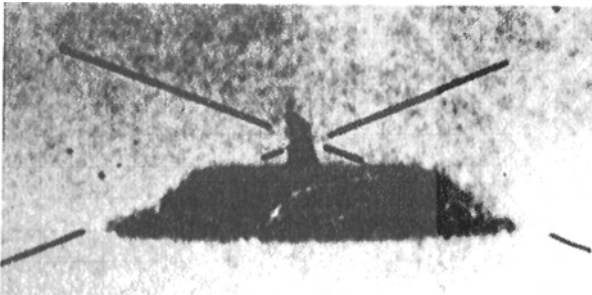
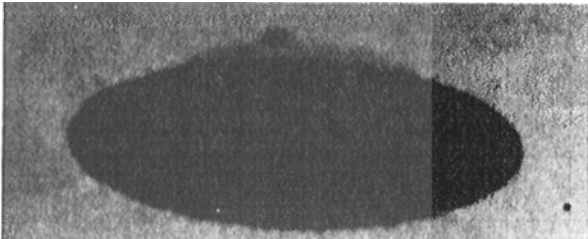
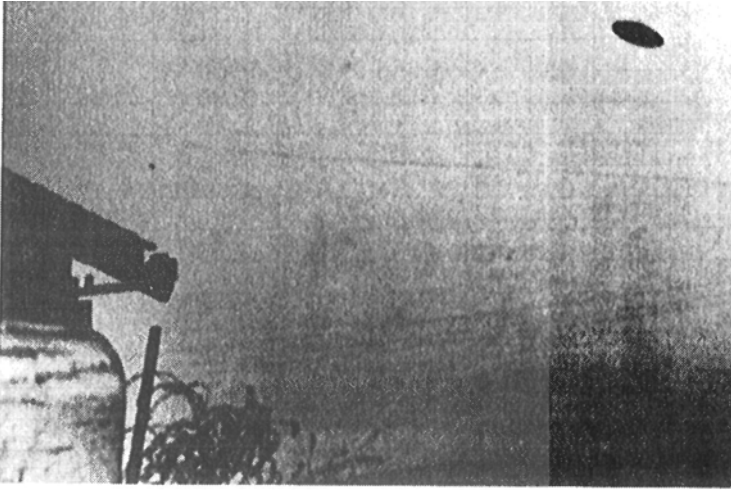

Photo 14. Oregon photos.

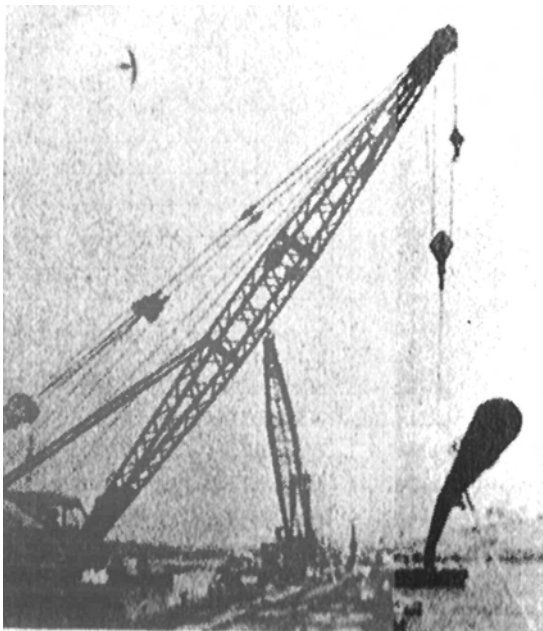

Photo 16. Anchor patterns.

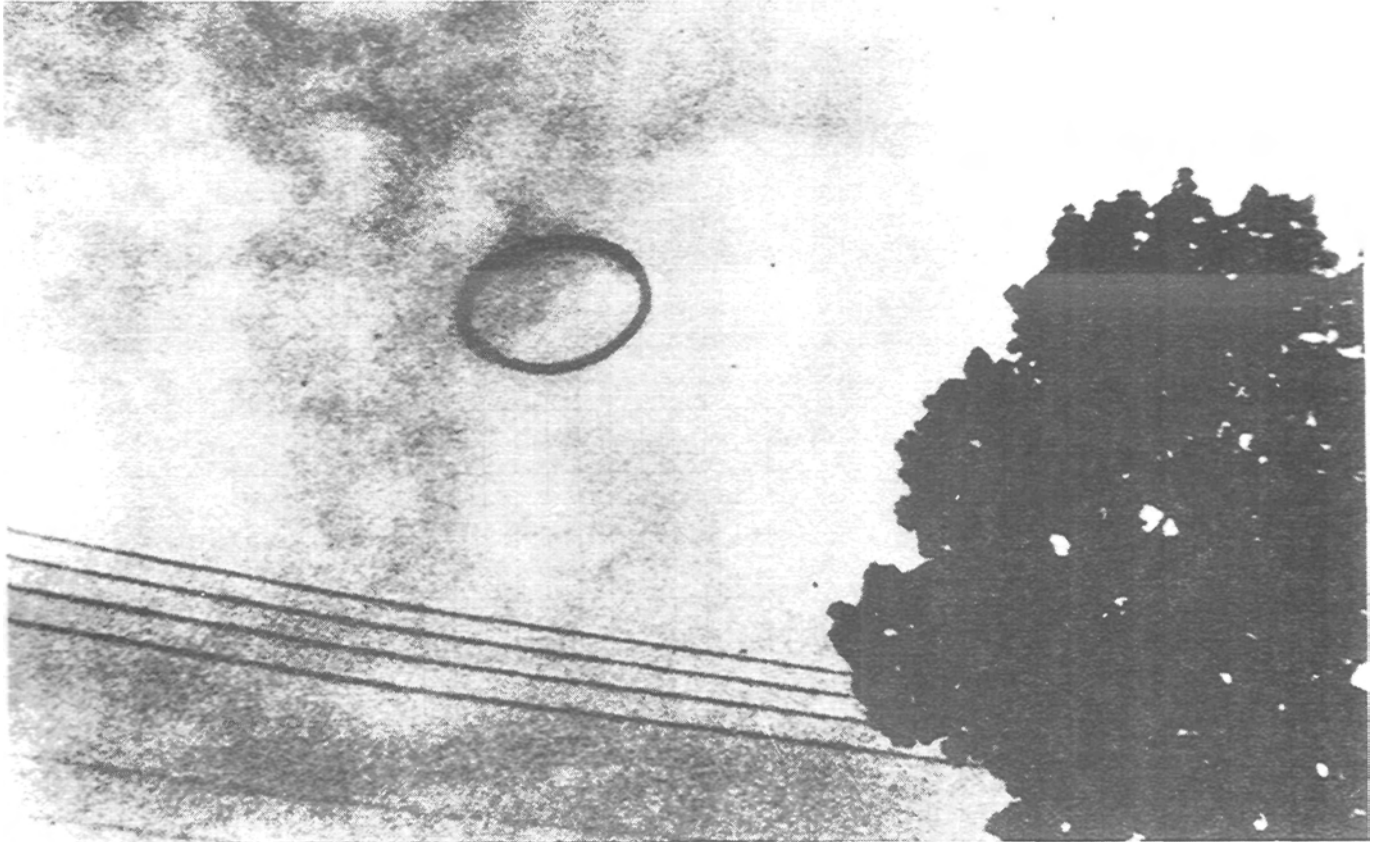

Photo 15. Black ring UFO.





Photo 17. Bifringement.

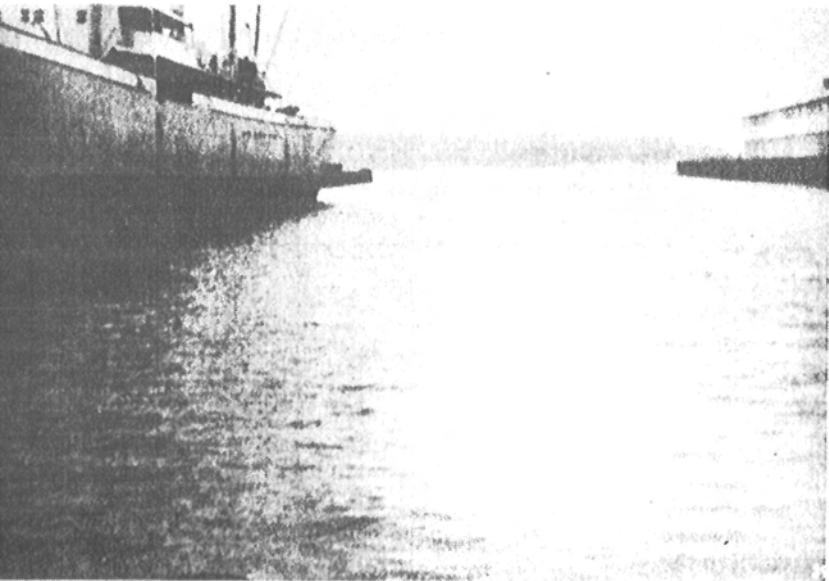

Photo 18. UFO In **water**.



The sighting occurred in June 1950. At the time I was home with my father in Woodville, Mississippi for the summer vacation from college. All my family were in the timber business — pulpwood and logs — and I was working for the summer with them.

It was a beautiful, warm, clear summer day with almost no clouds at all. Coming out of the woods on a pulpwood truck with the last load of the day (about 4:30 or 5:30 PM), the truck was slowly making its way across a large open field to the county road. Suddenly a light was seen in the extreme upper atmosphere, glowing with a fierce white radiance, very similar to the light emitted by a magnesium flare or by burning magnesium. Some object was apparently entering the atmosphere from outside it, but the velocity of reentry was far slower than reentry vehicles that would be fired many years later on U.S. and Soviet rockets. As the fiercely glowing light smoothly descended, a change occurred. At that point gray smoke also appeared in the white smoky trail being left by the object, and the trail became turbulent from that point on. Then an orange color appeared at the front of the descending, tumbling object, in the light being emitted. The smoke trail from this orange glowing color was darker gray. The object tumbled slowly downward, burning fiercely, until utterly consumed, still at an extremely high altitude (I would estimate still above 100,000 feet). In the sky the smoke trail that had been left persisted for a while, until it was gradually dispersed by high atmosphere winds. In the picture a great deal of dispersion has already occurred.

So far as is known to me, and I have had considerable missile experience, neither the U.S. nor the Soviets were firing any sort of vehicle in 1950 that could account for the phenomenon. Furthermore, even if we postulate a reentry vehicle from a large rocket, its velocity was far below normal reentry velocity, and this cannot be accounted for. The object also could not have been a meteor because its velocity was far too low.

For the doubter let it be pointed out that even if a high drag, low ballistic coefficient reentry vehicle comes into the earth's atmosphere on a downwards plunge and rapidly slows down, its initial velocity is quite high, and its rapid slowdown is quite apparent. This phenomenon did not exhibit such a characteristic.

## **7. The 1966 Dennis Billings UFO Sighting**

At about 7:00 P.M. on the night of September 23, 1966, Dennis Billings and his wife and daughter sighted a UFO at close range. The close UFO was one of a total of four sighted by the family in about one hour. The sighting occurred in Decatur, Alabama. The UFO phenomena occurred after anomalous physical effects were noted. From the alley by his back yard Dennis, who had taken out the garbage, began to hear sounds from inside a neighboring house at some distance as if he were physically inside the room in which the sounds were occurring. These sounds consisted of conversation and dish-rattling in the kitchen where two women were apparently cleaning up the table after the evening meal and washing dishes in the sink. Then the sounds changed to those from another room where children apparently were playing games. Peculiarly, the sounds seemed to originate from wherever Dennis focused his attention, such as the garbage can, the house, etc.

Shortly afterward his daughter followed him into the yard as he left the house to go to a football game, carrying his binoculars. She spotted a cluster of lights moving along slowly in the sky above the treeline, and called his attention to them.

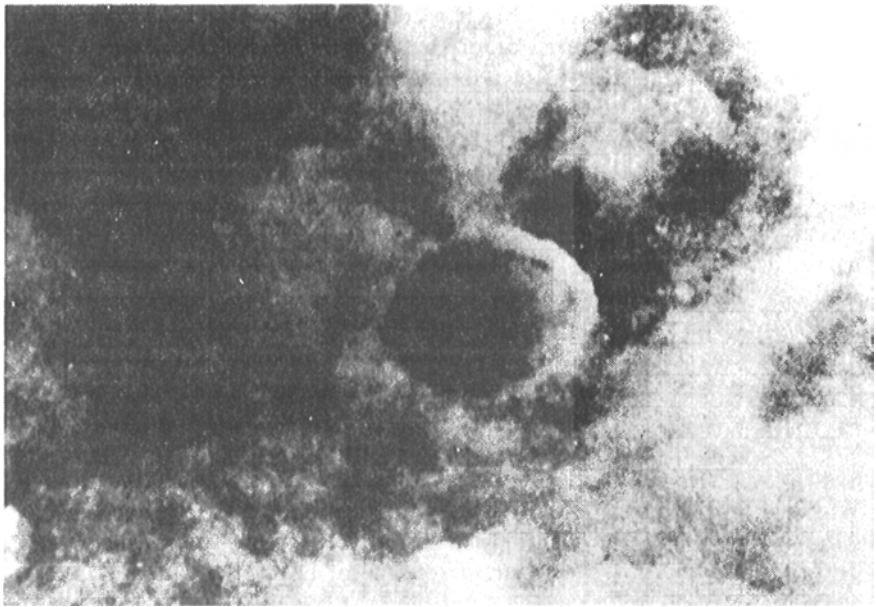

**Photo 19. UFO in clouds.**

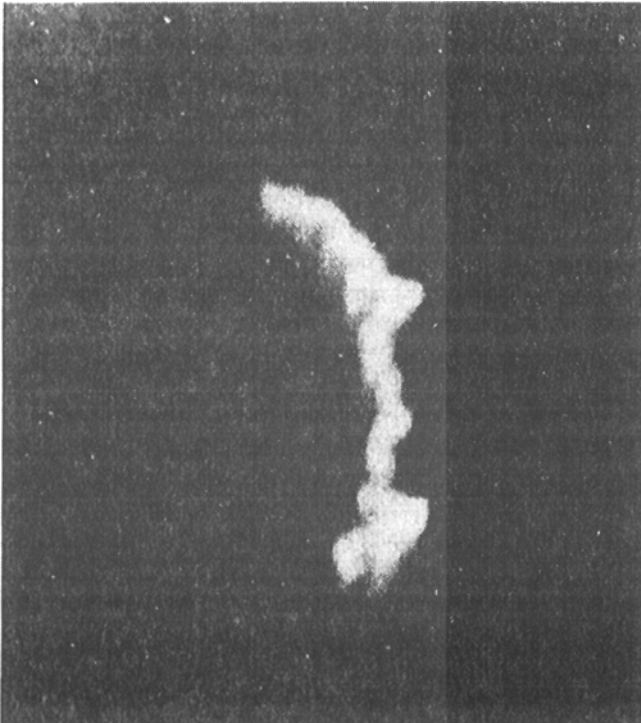

**Photo 20. UFO seen by the author.**

Through binoculars the cluster of brightly colored, flashing lights could be seen to be one object about two blocks from Dennis's house, moving very slowly and making no sound, about fifty feet above the trees.

Just then Dennis's wife turned on the exterior house lights which illuminated the entire back yard. As she came out into the yard, an object, a fiery red, glowing, round ball of light about twenty-five feet in diameter, appeared just above the neighboring house in back, the same house from which the anomalous sounds had been heard a few minutes previously. Strangely, the glow of the object did not appear to illuminate the rooftop of the dwelling above which it hovered.

The glowing light seemed to be composed of a tremendous amount of energy, and there was violent fluctuation, turbulence, and movement of the light energy within the sphere. Another way to describe its dynamic characteristics is to visualize it as being composed of individual particles of light or incandescent particles of highly charged matter moving rapidly in a circular plasma. The light itself appeared to be comprised of hundreds or even thousands of individual light sources confined to the circular shape.

Within a few seconds the individual lights began to coalesce and form into a solid light with no agitation, dimming in incandescent intensity and changing from red to orange to yellow. As the circular shape of light grew dimmer, a rocket-shaped object formed in the center. After the light had finished changing to yellow and was much dimmer, the rocket-shaped object began to rise, with particles of light from the sphere clinging to it and falling off toward the ground, where they evaporated and disappeared. The rocket-shaped object had no wings or tail fins, and it picked up speed and sped away, streaming an exhaust tail of light or flame behind it, similar to a welding torch's flame or a flaming sparkler. The object made several spirals as it rose and then headed in a straight line toward the stars. As it rose, it also made a slight arc toward the moon, which was full or nearly full, and passed across its face. As it crossed the face of the moon, its rocket-shaped outline could be clearly seen.

Astonished, Dennis and his wife began discussing what they had seen, still standing in the back yard. At this time the anomalous reception of unusual sounds began again. At first Dennis seemed to hear a train on a distant track although there are no railroad tracks in the vicinity. The sound seemed to come closer until he seemed to hear a train passing by immediately in front of him with its wheels clicking on the joints of the steel rails. Then they heard other sounds similar to automobiles and trucks on a freeway, again very close, although there is no freeway in the vicinity either. The whining motors and honking horns of these unseen vehicles could also be heard. Turning first in one direction and then in another, Dennis could hear the anomalous sounds seemingly originating from wherever his attention was directed. Other sounds such as airplanes flying in the sky also came in. Then he heard another sound like a high-pitched tuning fork, and it began to increase in frequency until Dennis's eardrums were hurting.

With this high-pitched frequency sounding and his ears smarting, Dennis looked up and saw a bright object positioned in the sky, larger than a star, and approaching him and his wife. As it approached on a straight line toward their back yard, it got bigger and brighter, until it stopped directly overhead, hovering 100—150 feet directly above the yard. The object appeared to be circular or oval in shape, and it descended with the flat side down. On its rear end the object was

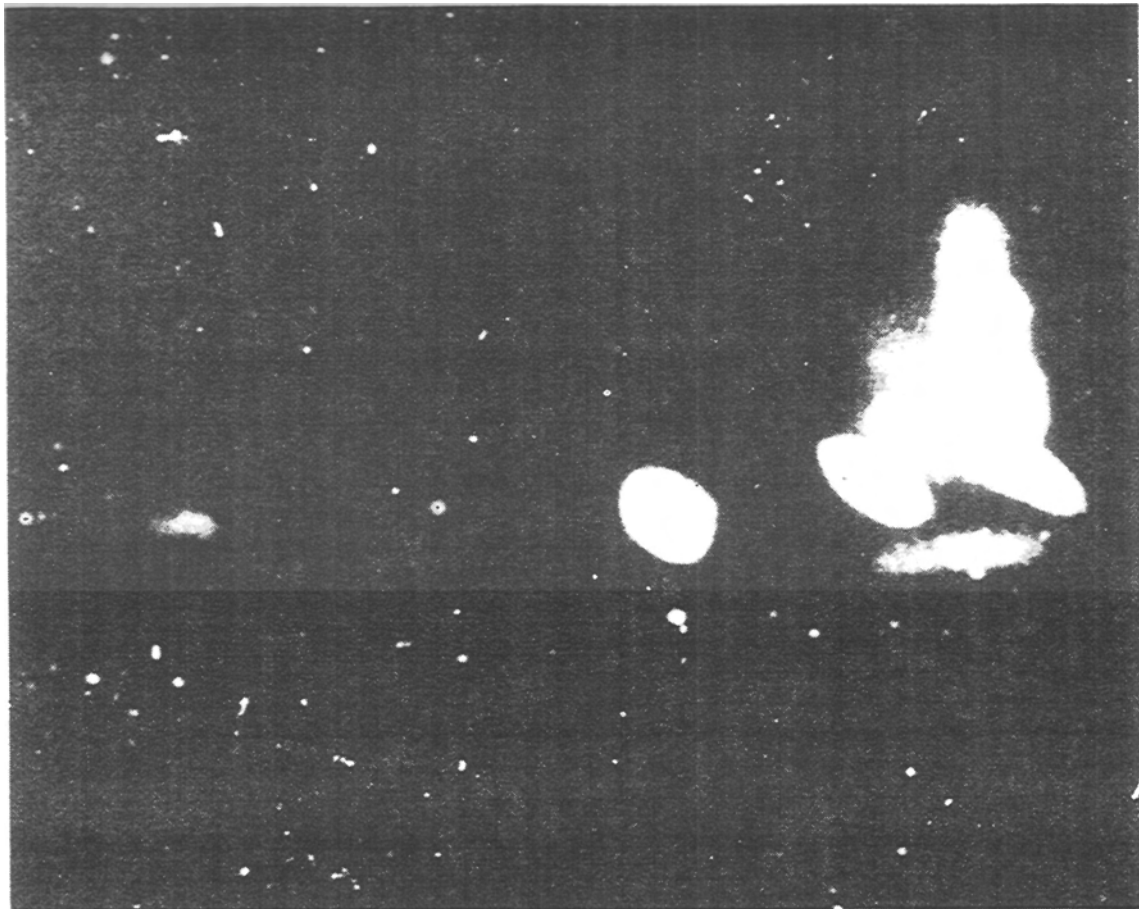

Photo 21. Second Billings UFO.

rimmed like a horseshoe with twelve washtub-sized blinking lights, each of a different color. These lights appeared to be controlled so that as one light blinked on, the other lights went off. In this way one light at a time blinked on and off in successive positions, so that a single light seemed to rotate around a complete half circle and cross at the open end, changing color as it progressed. On one side of the horseshoe the light positions were bright red, on the next yellow, on the next pale green, on the next a darker blue-green, and the final light on the opposite side of the horseshoe pattern was a very bright blue. Underneath the center of the object was what appeared to be a hemispherically-shaped plastic capsule or shield. This capsule was completely blacked out; yet through what appeared to be smoked glass, movements or shadowy activity could be seen. Dennis assumed that this was the exhaust section of the craft and that what he was seeing was probably smoke coming out of a black hole in the craft.

Around the outer perimeter of the craft, and about two feet out from it, was an illuminating light which circled the object like a halo or corona. Dennis had the eerie sensation that the object was intelligently controlled and that he himself was under close observation.

At this time Mrs. Billings became extremely frightened, ran into the house and got the baby, and crawled under the bed until the craft had gone.

As she left in fright, the craft lifted up in the sky a little and began to move slowly away, so slowly that Dennis could walk along beneath it as it moved across the back yard and into the front yard. Walking under it and looking straight up at it, he was able to observe closely the blinking lights and their operation. When the craft had been motionless, the lights had blinked on and off slowly, so that they moved in a slow, pulsating motion from position to position around the horseshoe pattern, changing color as they went. As the craft began to move and pick up speed, the lights began to increase in pulsation frequency and thus to appear to move faster around the horseshoe pattern. As the craft moved even faster, the light pulsations became so short and fast that they seemed to be spinning around the horseshoe in one continuous blur of motion.

As the object left Dennis's yard, it moved into the sky and away, but not too far, until it had positioned itself over the airport (Pryor Field) as a large bright object. At this time Pryor Field was serviced by Southern Airlines. As one of the commercial aircraft took off, the UFO followed it back directly over Dennis's house, then left the aircraft and repositioned itself in the sky in its original position over the airport, hovering motionlessly.

After hovering motionlessly for about fifteen minutes, the UFO suddenly shot down in an arc toward the ground, passing below the tree line and out of Dennis's view.

Dennis waited for about ten more minutes, when suddenly the UFO shot back up into the same position in the sky, seeming to follow in reverse the same arc on which it had descended. It remained in this position, hovering in the sky above Pryor Field for another ten to fifteen minutes. Then a similar object approached and joined it, and the two seemed to merge or dock together. They remained motionless for about five minutes more, then moved across the sky, still joined, until they disappeared below the horizon.

According to the newspapers the next day, this object or something similar had been seen all over the eastern half of the U.S., and had been described as "multi-

colored clouds."

## 8. The Second Billings UFO Sighting

If Dennis and his wife had experienced only one UFO, the incident would have quietly faded away in the unwritten annals of ufology. However, such was not to be the case.

Dennis vowed to himself that, if such an incident ever occurred again, he would get a photograph of the object. And just before Labor Day in 1970, Dennis got such a chance, and indeed made good his intention.

On that night, with almost totally clear skies and a bright moon, Dennis's wife came rushing into the house in Decatur, Alabama and excitedly reported to Dennis that she had seen another UFO. Rushing into the yard, all Dennis could see were some distant white lights — too far away to say positively they were UFO's. However, recalling the multiple UFO's in the previous incident, Dennis and his wife took up separate watches on each side of the house. Dennis also thought of his Polaroid camera left in his car parked in the driveway, so he went to get it.

Standing between the trees, Dennis looked up into the sky and saw a UFO suddenly triggered into position, as if his thought and intent had pulled a switch and the object had suddenly appeared, positioned perfectly for his observation, pouring light from underneath for a distance of about twenty to thirty yards. This light seemed to emit some immense force and was colored like the fire, whiteness, and glare of a welder's torch. The tail diminished as the craft lowered. Dennis snapped a picture when the craft's tail had shrunk to only four or five feet long. He pulled the tab on the polaroid film and ran into the street under an outdoor light to see if he had recorded a UFO. When he saw he had done so, he then noticed the object had descended and made a left turn, moving eastward down Nelson Street slowly at about five miles per hour. Its porthole lights were still clearly visible and no sound was being made. Dennis hurried after the UFO and caught up with it at the end of the street near a T. V. A. easement, where large electrical power lines were located, running generally north to south. He got slightly ahead of the object as it traveled parallel to the power lines and as the craft passed directly over him. At the very instant he pressed the shutter, all lights in the craft instantly extinguished as if his mind had been read and the photograph deliberately prevented. The now darkened, cold, lifeless-appearing craft moved smoothly away, passing over Mallard Park where a Marine Corps Band was playing. The second photograph showed no lights whatsoever.

One of the local newspapers then printed the story and the picture, and Dennis received a call from one of the national UFO agencies. After giving the agency his photograph, his camera was mysteriously stolen from his automobile, and the agency then claimed to have lost his photograph. However, they underestimated the determination of Dennis Billings.

Dennis simply got on a plane and went to Washington, and proceeded to the office of the head of the UFO agency. The president of the organization had said that he would be out of town for several days and would be unable to see Dennis. Nevertheless, Dennis went to his office, where his secretary repeated that the gentleman was out and would not return for the day. Dennis barged into the office over the protestations of the secretary — including the threat to call the police and have him removed — and proceeded to search for his photograph, eventually finding it in the

desk drawer of the president of the organization. He retrieved his photo and returned to his home. Without his personal determination to retrieve his property, the photograph — like so many others over the years — would have been "lost." The immediate question that occurs is: Isn't it curious that one of the major UFO organizations in the U.S. — supposedly devoted to solving the UFO mysteries — exhibited the desire to misappropriate a really good picture of a UFO and see that it disappeared from the scene?

At any rate, Dennis got his photo — and a beautiful photo it was. Furthermore, the incidents experienced by Dennis Billings are classic examples of my theory. Many anomalies in the incidents will not fit orthodox theory or orthodox ideas about reality. The "pieces of light" seem to be almost intelligent. There was a close coincidence of thought/intent/expectation and kindling burst into observable reality, plus a great deal of sky-watching and expectation by Dennis between the first UFO incident and the triggering of the second (i.e., a long kindling time, just as Patterson experienced before he got his excellent movie shot of a sasquatch). And there was close experience of very distant sounds (to be expected in hyperspace, where ordinary distance can be shortened or even eliminated). Furthermore, there were multiple witnesses to the UFO incidents, and Dennis got his photograph. Psychologically, it may even be significant that for several years Dennis vowed to take a picture of any other UFO he might later see, and when he got a picture, he was prevented from getting another. And on the photograph obtained, one can see that the "craft" form of the tulpoid is only partially materialized, since the stars can be seen right through the vehicle's midsection. This is similar to the strange transparency of the Doc Shiels photograph of Nessie (the Loch Ness monster), which Ground Saucer Watch found when they performed a computer analysis of his photo. (The second Shiels photo showed that the water was being forcibly moved by Nessie, so the tulpoid was at least partially materialized.) Yet such is to be expected if one is dealing with partial materialization of tulpoids.

Finally, the entire area is located in the Tennessee Valley Authority's project. Great electrical transmission lines go through the area, and there are many long lakes and the Tennessee River. So an excellent kindling medium is provided, and many UFO's are seen over the Tennessee Valley.

The Dennis Billings photo remains one of the best UFO photographs ever taken, and coupled with Dennis's astute personal observations, it provides a key-stone insight into the actual nature of the UFO phenomena.

## **9. The 1973 Pascagoula UFO Sighting**

In October 1973 one of the greatest UFO flaps of all time occurred in the United States, and created headlines because of the bizarre increase of contactee incidents. One of the most sensational of these was the purported abduction of two men in Pascagoula, Mississippi, who were allegedly taken aboard a saucerlike craft, examined, and released.

Shortly afterwards another incident happened in Pascagoula, which drew little attention. In this case, underwater phenomena were involved, because two U.S. Coast Guard petty officers investigated the object and made physical contact with it. An official Navy investigation was made and a report written. Unusual characteristics, highly suggestive of a device using psychotronic effects, were displayed by the object. I suggest that this device may well have been a Soviet psychotronics de-

vice, taking advantage of the UFO flap as a screen to carry out clandestine activities.

In Pascagoula an illuminated underwater object followed the boat of Raymond and Rayme Ryan, who tried to beat it away with an oar. The nine witnesses, including two Coast Guard investigators, described the object as metallic, rod-shaped, two to three feet in length, and four inches in diameter. It was attached to an oval-shaped beam ahead for four to six feet. It looked like a mini-submarine and moved at four to six knots in four to six feet of water. Although it sounded like metal when struck, it could not be struck consistently, and its light, when illuminated by a flashlight, turned off immediately and then on again after about one minute. The portion of the Ryans' oar that was under water could not be seen from the surface when the object's light beam fell on it.

At this point I would like to make some general remarks about the nature of UFO's. (1) The UFO-generating mechanism and the psychotronic mechanism are the same. (2) The Soviets may even be able to psychotronically evoke particular types of UFO phenomena at will. (3) A small number of UFO phenomena could even be generated by the Soviet Union as part of its psychotronics deception plan. However, most UFO phenomena are definitely not of Soviet initiation, (4) An explanation of the UFO phenomena is briefly sketched out in my section on psychotronics. (5) Some of the NASA photos taken of moving lights in orbit around the earth may have been of Soviet-initiated effects. Like the radiation of U.S. personnel in the U.S. Embassy in Moscow, this effect could have been intended to evoke U.S. high level reaction, to positively assess whether the U.S. had any knowledge of psychotronics, and if so, what that level might be.

## 10. Other UFO's

A brilliant, "crystalline-like" UFO was seen over Madrid, Spain in 1968 and was chased by Spanish Air Force planes. Whenever people are significantly structured in their thinking, symbolically "sharp" and "crystalline" tulpoids often are seen, representing their ideas. Many such UFO tulpoids are seen over Iron Curtain countries, and over countries such as Spain that have one dominant religion and culture.

In October 1973 the governor of Ohio, John Gilligan, saw this UFO phenomenon along with over 100 other people. The police were notified by the governor, and this photo was taken by the *Columbus Evening Dispatch*. Note that the tulpoids remain in the first bioframe (see Part Two), and even though their intersections change shape, the second one remains in a "burst mode."

In 1965 Rex Heflin took four pictures of a highly materialized UFO near Santa Ana, California. In the fourth photo the dematerialization "photon absorption" effect is shown: if orthorotation into higher dimensional space is made in one direction, photon (light) is emitted. If the orthorotation is made in the opposite direction, photons are absorbed. In one case "glowing light(s)" are associated with the UFO's hyperdimensionality, while in the other case "black rings" or "smoke" are associated.

## FALKVILLE SPACEMAN

These two pictures are black-and-white versions of two of the photos taken by **Falkville, Alabama Police Chief, Jeff Greenhaw, in an encounter during October**



1973. Greenhaw had received a call from one of his constituents to say that a UFO had landed in her pasture, and he was proceeding to investigate the incident. In his police cruiser he carried a polaroid camera which he used in his police work.

Driving down a narrow gravel road, Jeff noticed a metallic-clad, suited figure walking down the road toward him, and he stopped his car to get out and have a look. For some strange reason his instinct was not to pull his pistol on the creature, and instead he started taking pictures as the creature/tulpoid walked toward him. The creature was holding something exposed in one of his hands, as can be seen in one of the photographs. As the tulpoid approached with no apparent intention to stop, Jeff then switched on the blue light above his cruiser, and the rotating, flashing light caused the creature to turn about and run away down the road. Jeff jumped into his cruiser and gave chase, eventually reaching about forty-five miles per hour without catching the tulpoid. His car spun off a curve and Jeff still had the photos — polaroids that he developed.

Bizarre things then happened to Jeff Greenhaw. His wife left him and divorced him (I suspect this had nothing at all to do with the UFO incident), he was fired from his job as police chief, vicious rumors were circulated that it all had been a hoax, and that a person had been dressed in an aluminum suit and photographed to give the appearance of a spaceman. Various fire suits were positively identified as having been the suit used. Jeff was discredited. Finally his trailer was burned down.

Before the trailer was burned, a friend of mine here in Huntsville, Warren York, visited Jeff and made photographic slides from the original polaroids with Jeff's permission. Shortly after that I had a chance to study these first generation slides for several hours, and some interesting things turned up.

The tulpoid's left hand is positively reversed in a mirror image fashion; it opens outward instead of inward as does a normal hand. (This cannot be seen on the photos shown here, but on the first generation slides it is readily seen.) Being an aikidoist, I am totally familiar with the degree of bending and flexing of most human joints, particularly the arms, wrists, and hands. And the mirror imaging of the left hand of the tulpoid is beyond question.

Furthermore, one can establish a clear shoulder line in some of the other photos, and a line just under the hat or "nazi-helmet" portion of the figure. From the other photos a remarkable thing emerges: there are only two places between the edge of the helmet and the chest that are sufficiently wide and sufficiently thick to contain a human head. The person would either have to have a neck about twelve inches long, or he would have to have a neck shorter than a Neanderthal's, with the head lolling down completely on the chest. Again, this can be clearly established in the original first-generation slides.

Finally, I have a letter in my files that establishes as a falsehood one of the rumors about Jeff. One person had admitted dressing in the suit and faking the incident, when in fact what actually happened was that Jeff went to his house immediately after the incident to ask this person to accompany him back to the area and search for the spaceman. When confronted in late 1977 by his family and friends, this person broke down and confessed that he had lied about the incident.

Finally, some other investigators dressed a person in an aluminum foil suit and photographed him, and there is no resemblance to the tulpoid photo. And Warren York investigated all the firesuits supposedly used in the hoax, including new suits used by the various fire departments and also by NASA at Redstone Arsenal. None of them resembled the tulpoid photo.

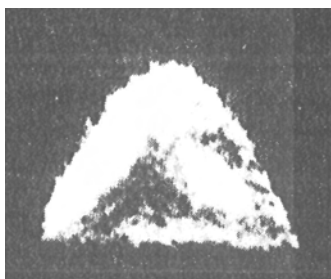

**Photo 22. Spanish UFO.**

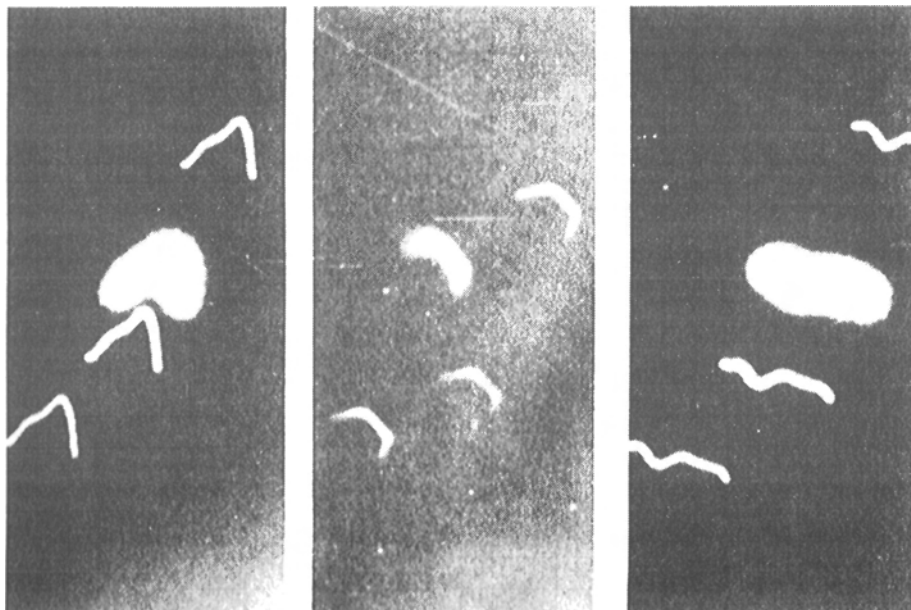

**Photo 23. Ohio UFO.**

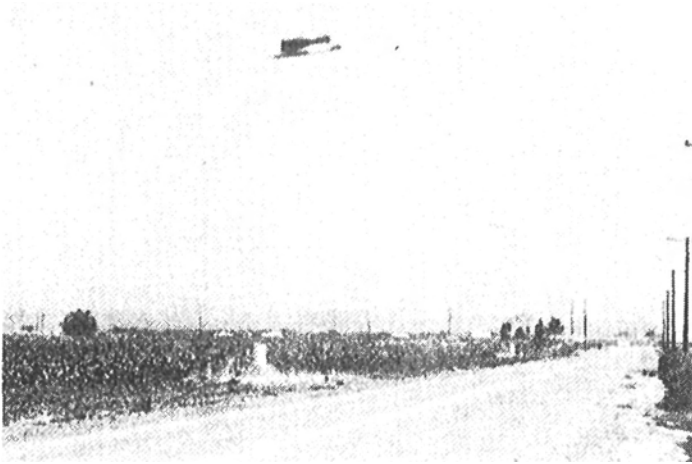

Photo 1

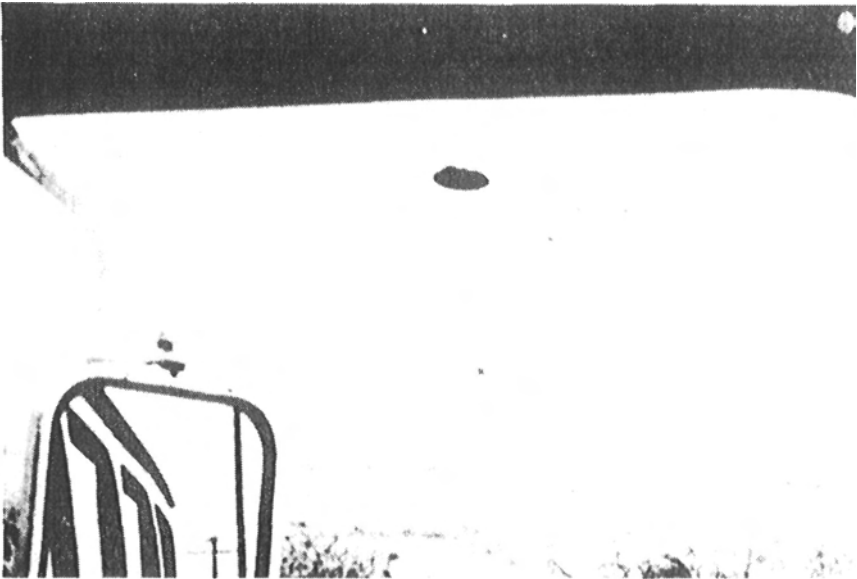

Photo 2.

Photo 24. Heflin UFO.

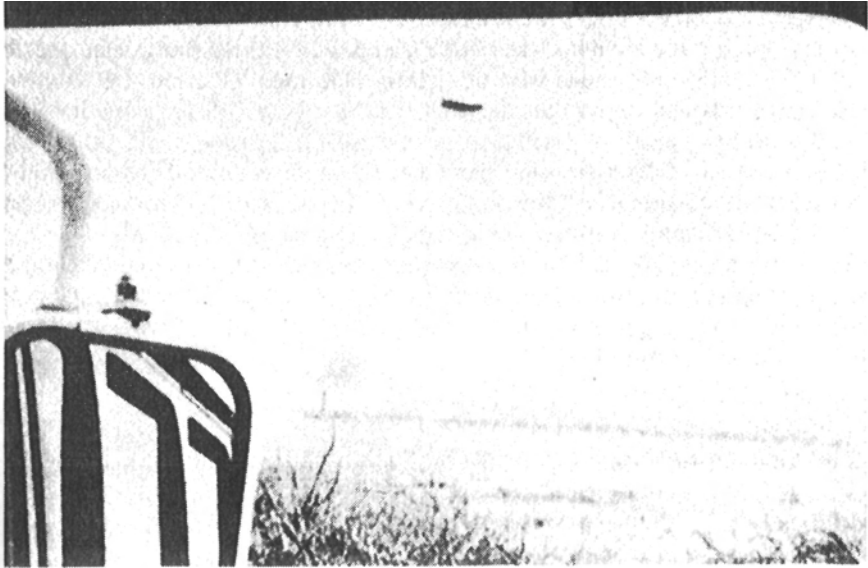

Photo 3

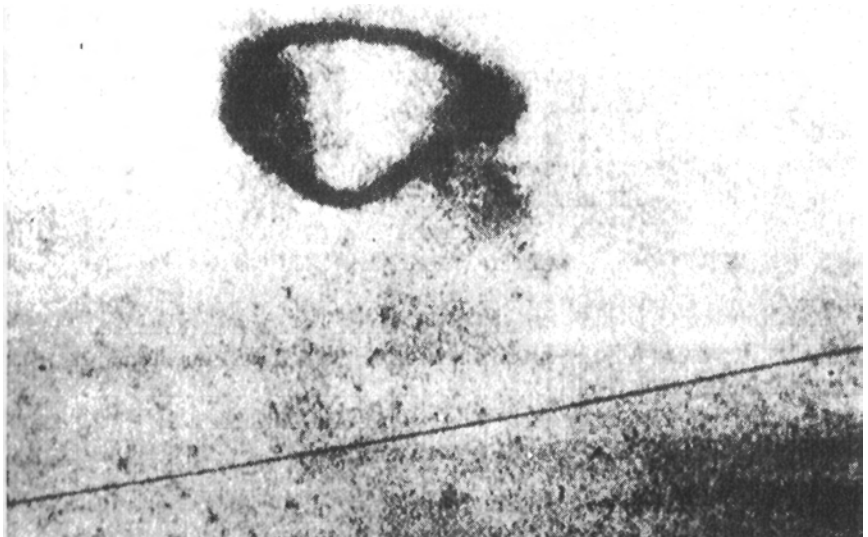

Photo 4 (enlarged)

Several photo experts have concluded that the photos are false, and several have concluded that they are not. A computer analysis concluded that they were false. However, what exactly could a computer show that would differentiate between a normal physical object and a well-materialized tulpoid?

In my opinion the incident was a fake *if and only if* three things can be established; (1) an individual exists with a horribly deformed left hand that is mirror-image backwards and opens outside away from the body; (2) the same individual either has no neck at all or else has a neck almost a foot long; and (3) the same individual can run forty-five miles per hour, faster than any other human in the world. Such an individual — if he existed — would be readily identified, and there would be no difficulty in ascertaining that he was the one involved.

There are other things about the case that I am not at liberty to divulge at this time out of respect for Jeff Greenhaw's confidence and privacy. But even so, the incident has a very high probability of being tulpoidal, and Jeff Greenhaw stands fully exonerated, in my opinion.

## MEN-IN-BLACK

The kindling of virtual state tulpoidal forms into the zeroth bioframe of a physical reality (materialization) can result in the materialization of living, breathing, functioning forms. There is essentially no limit on the format that may be obtained. Sasquatch, Nessie, fairies, demons, angels, mothmen, skunkmen, yeti, kangaroos, etc. are just a small sampling — as indeed are UFO-nauts such as little green men, space-suited astronauts, androids, robots, etc. These (usually) fleeting phenomena are physically real when in the materialized state (zeroth bioframe); unfortunately the tuning which is accomplishing the collection and kindling is usually unstable, and the stability to maintain the materialization lasts only a short time.

One of the consistent phenomena experienced by many UFO investigators is that of men-in-black. Typically, oriental-featured men in dark suits appear and demand the investigator's material, instructing him to cease his efforts. Usually they have almond-shaped eyes that never blink, and speak telepathically without moving their lips. Variations, of course, occur.

Here is an incident that happened to a friend of mine in the city where I live (Huntsville, Alabama). At the time my friend was an ardent UFO investigator and even wore a radiotelephone so that he could be contacted quickly at any hour to go and investigate UFO incidents in the field. He is the friend who investigated the Jeff Greenhaw case and took slides of the original Greenhaw photos before Greenhaw's trailer was burned.

A friend of his, a girl with psychic abilities, was approached one evening in her apartment by two medium-sized, almond-eyed men of oriental cast, in typically dark suits. These tulpoidal gentlemen's eyes never blinked and they spoke to the girl telepathically without moving their lips. They handed her an envelope containing two ancient coins and instructed her to give the coins to my friend, and inform him that he must keep them on his person at all times. After other messages that completely frightened the girl, the two tulpoids left, never to be seen again.

In tears from fright, the girl contacted my friend and between fearful sobs urged him to take the envelope and get it away from her, as she never wanted to see it again or the two men who had brought it.

My friend picked up the envelope and later examined the two coins. I also personally examined them: to anyone who is sensitive, the coins radiated an invisible unpleasant tulpoidal energy.

The investigator then photographed the coins, and daringly placed one on a string around his neck against my own advice to seal them up against light. He promptly broke out in a rash from head to foot and was shortly forced to remove the coin and seal it away. Interestingly, photos of the coins seemed to have about half the effect of the actual coins.

For a period of two years I kept my copies of the photos sealed against light and stored in a file cabinet. To my surprise, several times when I went to retrieve the photos, they would alternately be there and not there. I simply state what occurred, without any change or justification. Eventually, however, their effect seemed to decay, and at that time there was no longer any problem in recovering them from the filing cabinet.

The men-in-black syndrome is based on our own unconscious tuning; since each of us has some unpleasantness in the unconscious, sometimes the tuned-in men-in-black can be very nasty indeed.

I am personally aware of several good researchers into the paranormal who have been forced to retire from the field to save their own lives and the lives of their families. As late as April 1978 a very good friend of mine has been forced to do just that because of overwhelming danger to his family from materialized tulpoidal phenomena.

In my own case I have found it expedient to work closely with a group of psychic friends in the American Association of Meta-Science. This group is capable of clairvoyantly peering into the unconscious to ascertain the most unpleasant blockages present, and forming energized thought forms to go in and cleanse the unconscious of most of the unpleasantness. In this way the unconscious can be kept relatively free of unpleasant tuning that might otherwise tune in something like the men-in-black. My own life and experience has not been free of tulpoidal tuning; however, it has been free (at least so far!) of tuning in anything really unpleasant, or nasty, or threatening to my family.

But I continue to be very grateful to my psychic companions for their understanding and assistance, and I continue to avail myself prudently of their services when needed.

## **SASQUATCH**

In many regions of the earth there exist legends of giant, apelike creatures of various sizes, hues, and dispositions. In the high Himalayas this takes the form of the yeti, a humanoid creature sometimes seen in the snows of high and remote fastnesses. Expeditions have in fact uncovered and photographed the yeti's tracks, and sightings by reliable observers have been made. Several parties have also reported hearing the yeti's strange vocal sounds.

In the remote Siberian wastes the Soviets have also reported such a manlike humanoid creature, even purporting to have captured one a century or so ago.

In the U.S. the tulpoidal form similar to this has been the sasquatch of the Pacific Northwest, known since Indian times, and observed hundreds of times by a variety of persons over the years. Nevertheless, in spite of intensive searches Big-foot continues to elude all pursuers while continuing to be sighted and leave foot-prints.

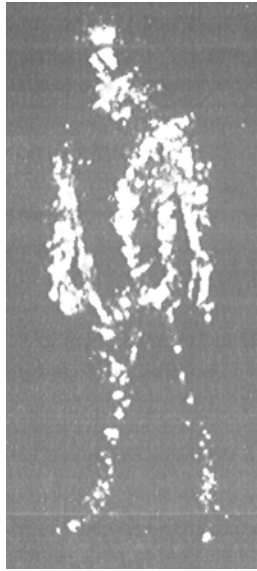

**Photo 25. Falkville spaceman.**

But Bigfoot cannot be caught by packs of hounds. (This has repeatedly been tried. His lair is never uncovered, nor can he be tracked to it. He has never been found dead of old age or injury. The bones of sasquatch have never been uncovered in caves or elsewhere.)

Furthermore, not just one type of footprint or one type of creature is seen; instead, a variety of shapes/sizes/types of creatures appear. This is one particular clue to the fact that we are not dealing with a species of shy and elusive wildman, but instead with a tulpoid.

Sasquatch cannot normally be found — as indeed Nessie and the yeti cannot — because shortly after each appearance he is no longer present in this bioframe.

However, as interest in sasquatch/Bigfoot grows and the effort to discover or uncover him intensifies, the kindling of the tulpoidal form intensifies. Today big-foot-type creatures of all varieties and hues are being seen throughout the U.S., from Maine to Florida, from Alabama and Tennessee to Oregon, Washington, and California. With this intensity of kindling, it is getting easier to evoke a bigfoot-type tulpoid, and as it continues, sasquatch is probably going to be tuned in and stabilized. If so, the past itself will just be changed, and we will be able to dig up ancient bones of sasquatch, and find his lairs, and track him down with dogs and capture him. In that case, sasquatch will become a respectable animal and will stabilize in our reality. Tulpoidal activity from the collective human unconscious can be stabilized and the entire past, present, and future changed by the awesome  $4 \times 10^9$  dimensional psychokinetic mastery of spacetime exerted by the species unconscious.

We also should not be at all surprised if the same thing happens to the placid Loch Ness monster. There is probably going to be a family of pleisosaurs living in the Loch eventually (and in many other bodies of water across the globe) — and spacetime will be changed (past, present, and future) in our zeroth bioframe to accommodate this small shift in the collective human unconscious. In reference to changing the past, it is interesting to note that Wheeler has recently demonstrated that, in the two-slit experiment (which contains the basis of quantum mechanics), it can be decided *after the fact* whether or not a photon has interacted with two slits or with one. Thus in at least one sense the past can be changed!

After several years' intensive search for and pursuit of the elusive Bigfoot in the Pacific Northwest, Roger Patterson finally obtained a short movie strip of a very large, seven-foot tall female with pendulous breasts and crested head, walking through a forest clearing with giant strides. This is perhaps the best frame from that movie strip. Sasquatch tulpoids have been known since ancient time by the Indians who lived in the area. It would be interesting to see what results could be obtained in materializing or partially materializing the Bigfoot tulpoid with a Reichian cloudbuster.

Bigfoot-like creatures are materializations from the collective human unconscious shaped and formed by the layers (race, culture, nation, territory, state, region, family, etc.) between the collective unconscious and the individual unconscious minds of the observers. The exact format depends on all the higher level "kneading" of the "dough" that is being forced out into materialization.

In the Pacific Northwest the Indian knew of the sasquatch long before the coming of the white man; in that region, a great deal of tuning has been accomplished, and the sasquatch is a rather well-tuned animal form, having well-



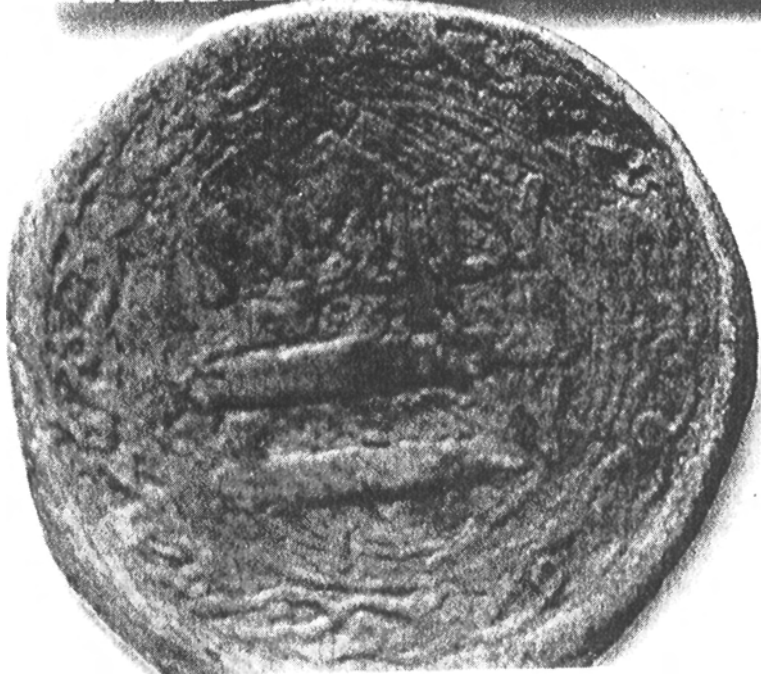

**Photo 26. An ancient coin handed to a psychic friend of a UFO investigator by tulpoidai men-in-black.**

defined footprints as shown in Photograph 28. In the East, the yeti has also been tuned for centuries, and a cast made from his footprint is quite well formed — though also quite different from that of a typical Pacific Northwest sasquatch. In New Jersey, on the other hand, for the last two or three years there have been a large number of Bigfoot sightings, but here there has not been the same degree of tuning for several centuries, and consequently the footprints look rather messy, like blobs left by the creature before it vanished back into dematerialization. Finally, in one case a person well-known to me stumbled into dematerialization phenomena of a very strong nature. One of the incidents involved the materialization of a really gigantic "superfoot" creature, which walked around all over the base of a mountain, leaving giant footprints two feet or so long. Though monstrous in size, superfoot is really ill-tuned and thus ill-defined, with footprints that are decidedly blobby in form.

## UFO's OVER THE SOVIET UNION

In 1961 locomotive engineers on a freight train from Moscow to Golytsino, when about forty kilometers from Moscow, sighted a disc-shaped object topped by a cupola approaching the train. The object slowed to pace the train and escort it for about one kilometer. Suddenly the locomotive engines went dead, and could be restarted only after the mysterious object disappeared.

On December 29, 1967 an Iliouchine 14 aircraft enroute from Zaporozje to Volgograd sighted an approaching UFO. As the UFO neared the aircraft, suddenly the aircraft's engines stopped in midair and the plane began slipping sideways toward the earth, carrying its panic-stricken crew to certain destruction. When the crippled aircraft was about 700 meters from the ground, the UFO abruptly disappeared. At the same instant the aircraft engines sputtered and roared to life again. The pilot righted the aircraft as lift returned, narrowly averting a crash.

On September 24, 1962 first one oval object then several others escorted a TU-104 airliner enroute from Vorkouta to Omsk and maneuvered around it with astonishing speed and agility. The eerie aerial escort continued for most of the flight, and the objects were extensively observed by both the passengers and the crew. The objects positively could not have been other planes, balloons, satellites, celestial objects, or other known natural phenomena.

In Latvia in 1965, R. Vitolniek, a well known astronomer, together with several scientific colleagues, sighted a triangular-shaped formation of four spherical objects, one at each of the points of the triangle and one a little larger in the middle of the triangle. Two of the scientists, Ian Mederis and Robert Vitolniek, made immediate calculations and insured that the objects were not satellites or normal orbital objects. The objects steadily shrank in size, leading Vitolniek and his colleagues to conclude that the objects were traveling away from the earth into outer space.

At least two Soviet astronauts, Colonel Bykovsky and V. Terechkova, have observed UFO sightings and reported them to the Soviet authorities. Many other UFO sightings have occurred in the Soviet Union and the Iron Curtain countries; **these** are just a sampling.

In fact, on several occasions Soviet defense forces have been committed into massive action against UFO's.

In 1959 numerous UFO's flew over Soviet rocket launchers at Sverdlovsk. In addition to being visually observed by a large number of personnel, they were detected and tracked on Soviet radars. Soviet military units were ordered into action immediately. Interceptors and anti-aircraft artillery batteries went into action and the air defense missile units opened fire. In spite of the fierce engagement of the elusive UFO's, none were hit or damaged and no results were obtained by the Soviet combat forces. Men, machines, guns, rockets, missiles and radars could not cope with the UFO's. The impact in the Soviet military of several such military actions must have been enormous.

In fact, such incidents as this probably were responsible for the establishment of an extremely high level and highly classified Soviet investigation of UFO phenomena. Given the decision to launch such an investigation — and it would be inevitable for the Soviets to take such a step when their air space was under open invasion by possibly hostile forces — the Soviets would have assembled a formidable scientific team to tackle the problem. Furthermore, given the highly classified military reports of such encounters, reports of UFO incidents at other Soviet installations and by other Soviet military personnel, and the steady occurrence of the normal range of UFO sightings and incidents over cities and villages, the Soviet system would have tolerated no scientific nonsense in opposition to the mission to discover the nature of the phenomena. In other words, the Soviet team from the beginning would have concentrated on finding the explanation and nature of the phenomena, not on whether or not such phenomena were real or were occurring.

In my opinion, a connection between UFO's and paranormal phenomena — and the new psychoenergetics which also was formulated by 1959-60 — was realized about 1960. The high classification of the Soviet psychoenergetics program then led directly to an official Soviet policy to debunk UFO's and paranormal phenomena if the work of any outside research group became too serious. Some Soviet scientists who had no connection with the weapons programs were allowed to work a little on paranormal phenomena and on UFO's. This was simply to provide a deception plan for Western scientists; in their contacts with their Soviet scientific colleagues, these Western scientists would see only a rather puzzling collection of simple laboratory experiments on telepathy, ESP, simple psychotronics, psychokinesis, etc. A limited number of Soviet papers dealing with these subjects, but of no particular theoretical content or very exact statement of experimental apparatus and conditions would be permitted in the open journals. However, close scrutiny of such activities would be maintained by the Soviet state, and no real breakthroughs would be permitted to occur or to be transmitted to the West. Ziegel, Dubrov etc. owe the limited work they were permitted to do to this Soviet deception policy.

They also owe the surveillance and harassment they have undergone to the Soviet policy of insuring that they would be permitted to do nothing significant, or to communicate nothing significant to their Western colleagues. Meanwhile, a rigorously controlled and highly classified Soviet psychotronic weapons development program continued apace. And the radiation of the U.S. Embassy (and the U.S. ambassador to the Soviet Union) in Moscow with weak radiofrequency microwaves containing psychotronic modulations began about 1959-60 and con-



**Photo 27. Sasquatch.**



Photo 28. Bigfoot cast.

tinues to the present. As explained elsewhere, this radiation was in fact another very clever Soviet intelligence probe: By observing how the U.S. reacted, they could determine whether the U.S. had any knowledge of psychotronics and thus whether or not the U.S. had developed secret psychotronic weapons and counters of its own.

## **The Sighting over Petrozavodsk**

Even more spectacular phenomena have occurred in Soviet skies and are continuing to occur.

For example, a mysterious phenomenon of great magnitude occurred in the skies over the Soviet city of Petrozavodsk at about 4:00 A.M. on September 20, 1977. Petrozavodsk is in Soviet Karelia about 130 miles from the Soviet-Finnish border.

First, a gigantic mass of light flared up in the skies over the city, glowing brilliantly, and hovered there. Fantastic streamers of light poured from the glowing hemispherical dome of light and radiated down towards the city. Tass, the official Soviet news agency, reported that it looked like nothing so much as a shining "jellyfish sending down a multitude of fine beams." It gave, Tass said, "the impression of a torrential rain of light." Where these fine beams touched windows, many windows were broken or perforated with small holes.

Later the glow died down and the jellyfish became a single giant bright semi-circle. It then gradually moved off in the direction of Lake Onega. But all was not yet over. Even after the bright hemisphere had moved away, great gray clouds appeared over the city with a semicircular aperture bright red in the center. These phenomena lasted for ten minutes or longer.

Being over the city and lighting up the sky so fantastically, the phenomena were seen by a large number of Soviet citizens and reported by them to the Soviet authorities. In fact, Tass admitted in its initial release that informative reports from witnesses were still pouring in and being analyzed. This interesting phenomenon is worthy of some remarks by way of explanation.

Not only is pressure from the Soviet threat transmitted through the collective human unconscious (ZARG) to the skies of Europe and North America; in addition, a backpressure is generated, which provides the impetus for initiation of appropriate phenomena over the Soviet Union and the Iron Curtain countries. Psychologically, it may not be accidental at all that the original shape resembled a giant jellyfish; the implication is that the psychotronic sting will also be transmitted to the Soviet Union by backlash whenever the Soviet psychotronic weapons are unleashed on the West. The shapes are also psychologically significant. First the Portuguese man-o-war's stings will be applied (this accounts for the tentacles toward the city); then the all-seeing eye (symbolized by the bright hemisphere) will check the results. And the results will be gloom and despair (gray clouds), surrounding death, blood, and destruction (the red center) left in the aftermath.

Thus in this materialized symbolic dream event of ZARG's, there is a clear warning and an omen to the Soviet Union about the end result that awaits it on its present course to attempt to conquer the world and unleash a great psychotronic barrage in the process.

Since so many Soviet citizens saw and reported this fantastic phenomenon in alarm, the Soviet regime could not ignore it or simply debunk it. The Tass release

thus tried the oblique dodge: the phenomenon was still being evaluated, reports were still being received and checked out, and an official of the Petrozavodsk observatory, Yuri Gromov, was quoted as saying the phenomenon was still a mystery but was confirmed by a large number of eyewitnesses. The Pulkovo observatory in Leningrad was quoted by Tass as speculating that the phenomenon was due to a meteor. And of course there one can expect the matter to be left in limbo.

An interesting development related to this UFO sighting occurred in the U.S. The October 3, 1977 issue of *Aviation Week and Space Technology* magazine carried a brief disposal of this phenomenon. The brief insert, Spook Show, referred to a "Soviet press ballyhoo" of the incident and stated that the incident was actually the launching of the Soviet Cosmos 955 classified military satellite from secret launching facilities at Plesetsk. This AWST insert is credited to Washington Staff.

My comment is that the launching of the Cosmos 955 may well have been the initiator of the event — a rocket firing does produce a tremendous ionized trail of burning exhaust gases rising up into and out of the atmosphere, and this is a bio-energy collector par excellence. However, a simple review of the time sequence of the phenomenon, its location, and its shape is sufficient to destroy any notion that one could mistake it for a simple rocket launch. And rocket launches had occurred there many times before, with no such phenomena or mass reportings by the population, and with no such news release by Tass.

## **FRENCH EXPERIMENTS WITH PSYCHOTRONICS**

Aime Limoge in France is building some truly unusual gadgets that are being tested and that work. Limoge travels widely in the Soviet Union, and attempts to duplicate some of the unusual Soviet devices he has been permitted to see. Some of Limoge's devices have a partially psychotronic nature, although none of his reports mention this.

One of his gadgets, a portable and battery-powered electroanesthesia device, was considered for purchase by the U.S. Army.

Another of his gadgets is a magnetic inductor of hypnosis, which has been used in medical treatment by L'Institut de Recherche d'Electro-anesthesie. Limoge is reported to have seen such a device in the Soviet Union, possibly because one part of the Soviet psychotronics deception plan calls for the deliberate release of information of this kind, in a manner to suggest that this is the latest state of development in the USSR. In fact, their research efforts probably go far beyond this point. However, we should note that this device can be used as a most efficient brainwashing instrument.

## **DOWSING**

To understand how dowsing works, we must first understand something about higher dimensional spaces. It should be evident that, if there is a type of energy being sensed by the dowser, that energy must be coming in or arriving from outside this three-dimensional world, since our ordinary science deals with the energies existing in this world, and none of these ordinary energies can explain dowsing. However, because of the work that has been done showing that dowsers are extremely sensitive to magnetic fields, this energy must be somehow related to the ordinary magnetic or electromagnetic fields known to science.

In the human being the mindworld must itself have a coupled kindling system to cohere its changes and kindle them into electromagnetic energy and energize the physical body. The body system which does a great deal of this is the acupuncture system of points, plexuses, and meridians. Also, all powerful emoters, such as the endocrine gland system, are deeply involved in the kindling of the biological organism's mind energies into electromagnetic energies to energize the physical body. The body and its biorhythms form a coherent tuner in the time channel to accomplish this kindling of time-nested vital thought energies into ordinary energy. Because a great deal of mind energy kindles into only a minute amount of normal electromagnetic energy, our minds normally have only a small effect in this particular three-dimensional world. So we can normally psychokinetically move a few electrons in our brain and nervous system, and generate an input signal to our otherwise inert physical servomechanism. Ordinary inert physics and amplification takes over from there, and we can only deduce the kindling as mental intent from observing many, many quanta of physical change, i.e., from macroscopic behavior. At any rate, the dowser has learned to detect, focus, and sense very fine levels of electromagnetic fields, which means that at these low levels the kindling of mental energies can represent a much greater percentage of the field than normal. Thus the practiced dowser can now discriminate many of the particular types of fluctuations or changes in these weak fields due to mind kindling.

Furthermore, I would like to point out that, since mind kindling comes into this universe orthogonally, normal distances do not apply. The entire physical frame appears to the mind world as a point, and thus is totally inside the mind of the operator/dowser. It is for that reason that a dowser can establish a coherent tuning (intent) between a map and the actual ground, or between a picture and an actual object, or between a rod and a person's physical body when sensing medical illnesses. In the mindworld frame, the dowser is only dowsing or detecting himself, and himself includes this entire physical world — the earth's surface and beneath it, the sun, the moon, the stars, or whatever.

Just as the body used electricity, magnetism, and electromagnetic signals long before man knew of their existence, it has used kindling of bioenergy from higher dimensional frames for a very long time, even though these have been unknown to mankind. And dowsing is a very old art indeed; the ancients used magnets without knowing of magnetic field, and they used dowsing without knowing of hyperspaces and hyperfields.

## THE STROBE EFFECT

These five pictures show one of the more interesting effects demonstrated by many tulpoidal forms: strobing or "coining." What happens is that, much like a flat rock skipping across the surface of a pond, the orthorotating tulpoid skips in and out of its intersection with our three-dimensional frame.

In the first picture a glowing spherical tulpoid is shown to skip or strobe several times while the camera shutter is open. It does not move in a linear pattern, but rocks around and back-and-forth.

In the second photo, an aerial photo, a UFO in photonic form (first bio-frame) reveals itself to be strobing or skipping. (In university classes on the paranormal, I often refer to this type of action as *coining*, since it resembles a bright quarter or nickel that is photographed by stroboscopic light while rolling around.)



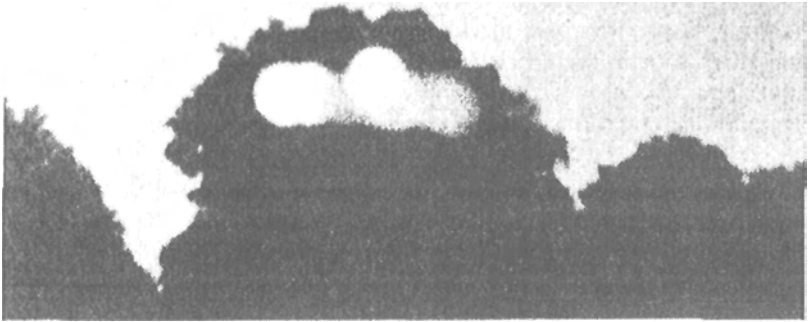

Photo 1

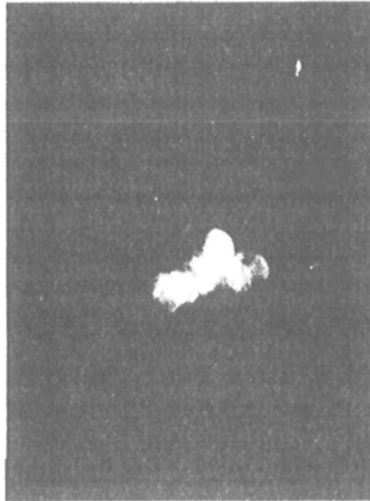

Photo 2

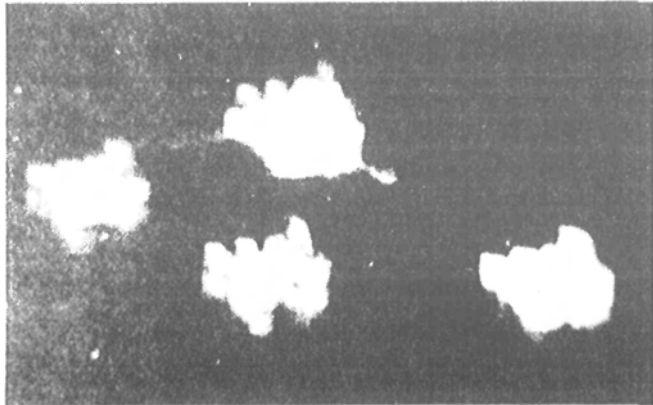

Photo 3



Photo 4

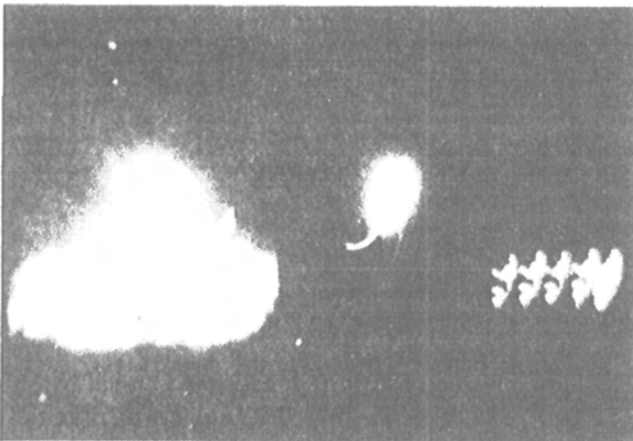
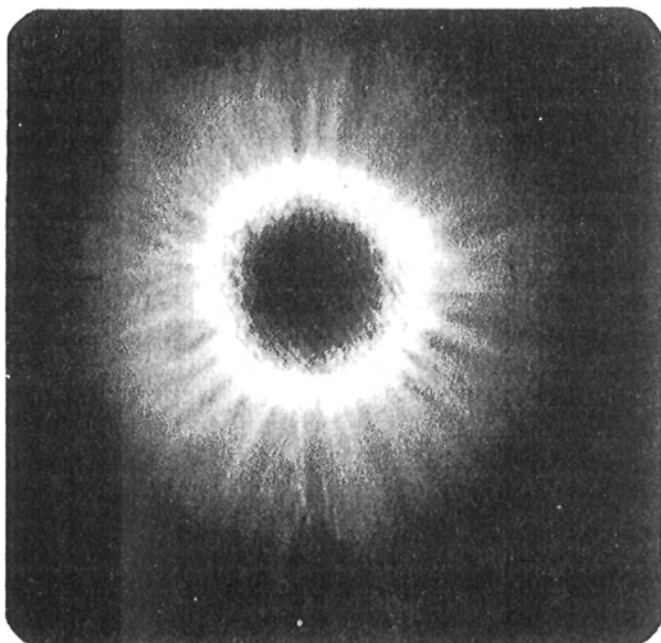

Photo 5

**Photo 29. The strobe effect.**



1. Even discharge from Inert object (dime).



2. Healthy person in calm state

**Photo 30. Kirlian photography.**

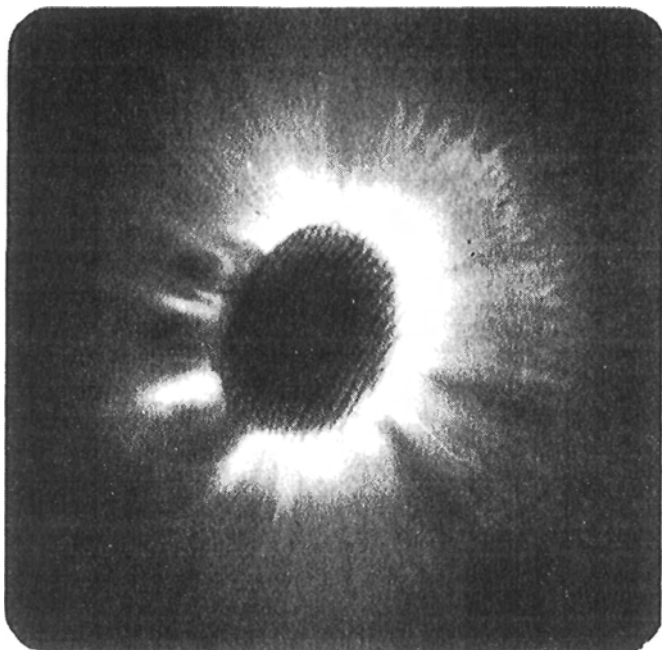

3. Person in meditatlon

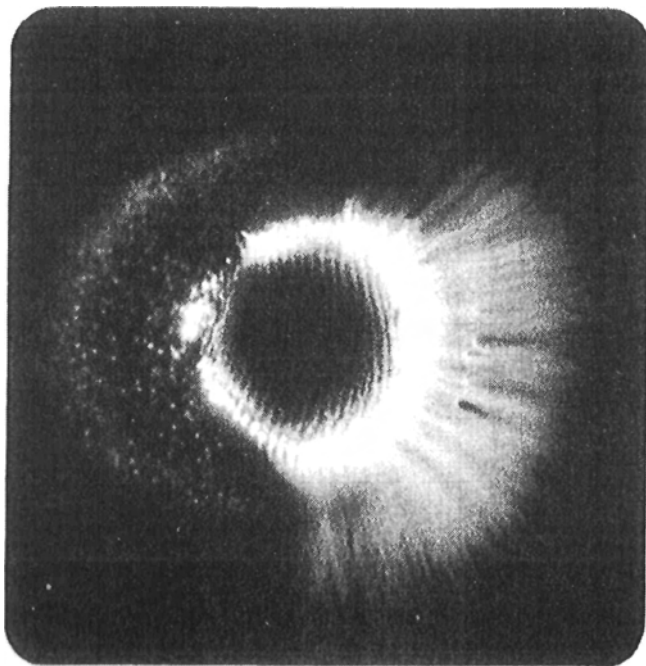

4. Angry person.

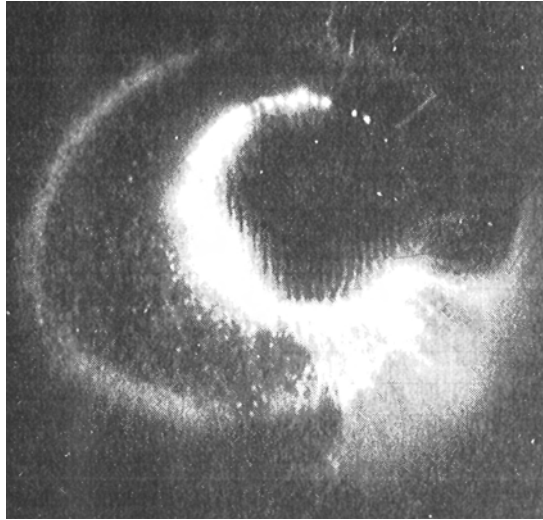

5. Person with London flu.

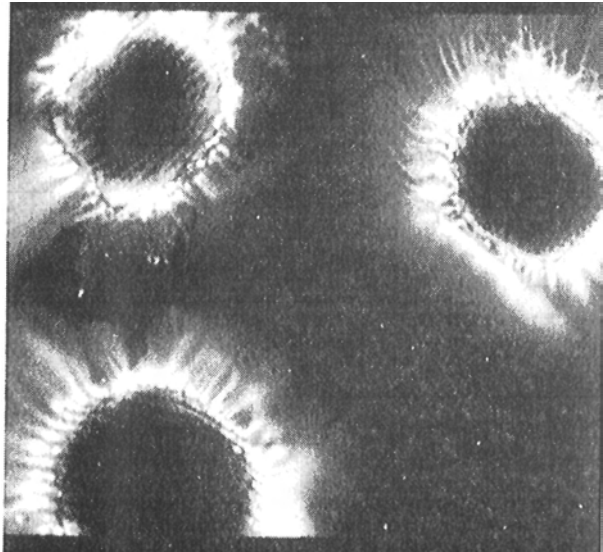

6. Interactions between three persons.

The third photo shows a more striated form. In fact, these forms show kindling and strobing at the same time. In addition, the physical size of the strobed intersection with our three-dimensional space changes during the photo exposure.

The fourth photo clearly shows both the striations due to strobing and also the variation in size of intersection in the zeroth frame by the hyperdimensional tulipoid.

Photo five again shows these effects, with the addition of the two "bursts" in the upper part of the left tulpoidal object and in the center tulpoid.

Significantly, psychokinesis also often demonstrates stroboscopic movement.

## KIRLIAN PHOTOGRAPHY

These six pictures show some major characteristics of Kirlian photography: (1) an even discharge from an inert object (a dime); (2) a balanced, gentle, even discharge from a healthy person in a calm state; (3) a gentle outgoing discharge enhanced on one side, and a gentle indrawing on the other, from a person in a meditative state; (4) strong bunching and outgoing discharge from an angry person (the word "emote," after all, means "move outward"; (5) choppy (as if out of control) bunched and outgoing discharge from a person ill with London Flu, with strong suppression of the normal, relaxed blue component at the lower right; (6) interactions between three persons, showing differing degrees of outgoing and barrier reactions.

The film itself only records ordinary photochemical interactions; it specifically does not record the aura. However, changes in the discharge patterns can be and often are induced by kindling bioenergy into the first biofield (electromagnetic field), inducing changes in the sparking pattern and intensity. Furthermore, this can occur fairly readily on such a high voltage series of discharges, which are excellent collectors for kindling.

As a final note, it should be pointed out that David Faust *et al* have published a technical paper in the scientific literature detailing the fact that Western experimenters have not yet duplicated the Soviet equipment and methodology used in their Kirlian photography. While David formerly pointed out in *Science* that experimenters must carefully control the variables—particularly moisture (water is an excellent collector for kindling)—he has been widely misinterpreted as having proved that water vapor was responsible for all Kirlian effects. This he has not done at all, nor did he intend to, since he himself is one of the most competent investigators in electrophotography.

## INTERACTION OF BIOFIELD, THOUGHT, AND SPARK DISCHARGE

These photographs are strong examples of the kindling mechanism. The subject tested was Uri Geller, a person with strong inceptive ability. In photo 1, the top two exposures are for control purposes, while in the bottom exposure, Uri is concentrating on the image of a circle. In photo 2, again there are two control exposures shown at the top, while in the bottom exposure Uri is concentrating on the image of a triangle. In photo 3, exposures are taken of Uri and a wristwatch; this is

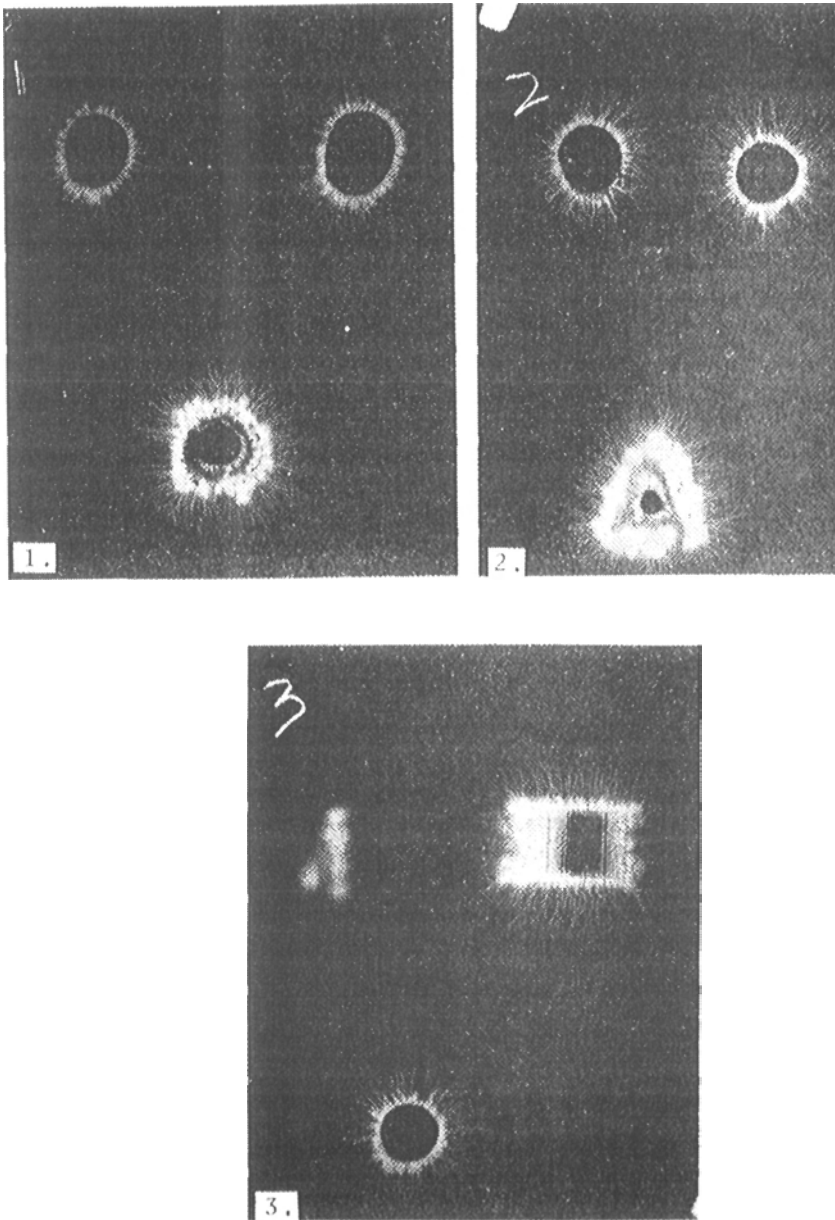
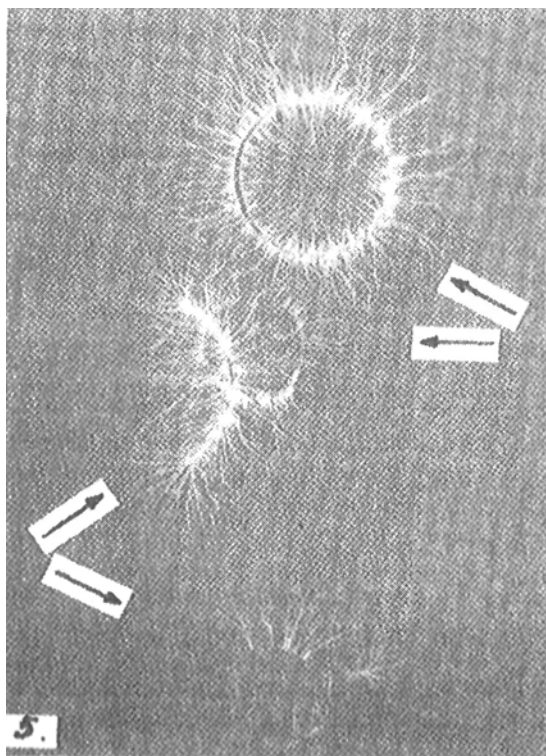
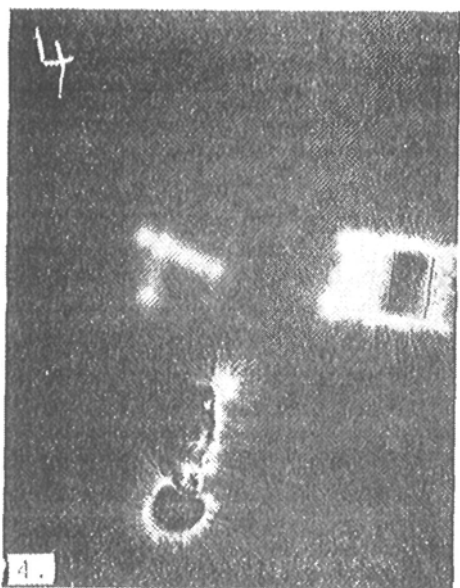

Photo 31. Interaction of biofield, thought, and spark discharge.





a control photo. In photo 4, Uri is attempting to send energy toward the wrist-watch, and a correlated change in the discharge patterns from his finger is evident. In photo 5, the arrows at the right point to control exposure of Uri and a silver ring; the arrows at the left point to the exposure made with Uri attempting to bend the ring psychokinetically without contact. The direct kindling of bioenergy in a force-field line intersecting the ring is striking. In such an intense kindling, note that the nuclear currents inside the nuclei of the silver atoms — where positive charge is being shuttled back and forth between protons and neutrons — are also being strongly kindled. Reductions in the positive charges steadily reduce the charged exchanging particles to quarklike particles, severely affecting the structural integrity and crystalline lattice directions of the base metal. By this means metal bending — or even breaking — is accomplished.

## **KERVAN EFFECT**

A direct and repeatable experiment showing that living systems can kindle bioenergy into ordinary energy and material effects has been made possible by the fascinating work of Louis Kervran. Kervran showed that chickens, fed a diet deficient in calcium but containing excess potassium, will have no calcium deficiency, since they transmute some of the potassium into calcium. Kervran's pioneering work has been duplicated in Japan and elsewhere, and the same effects have been demonstrated by living plants.

We may consider a neutron as a sort of bound system of a potential proton and a potential electron. Psychokinetically killing the charge on the potential electron converts the electron into a neutrino, leaving behind a proton now freed. For the one percent or so of potassium that is a calcium isobar, this process can produce ordinary calcium. Thus in a potassium-rich diet the chicken can psychokinetically transmute enough potassium into calcium to remain healthy.

Kervran was nominated for a Nobel Prize in 1977 by the Japanese researchers; his work is direct proof of the ability of living systems to violate present physics, and of the ability of mind energy or bioenergy to affect matter psychokinetically.

## **PSYCHIC SURGERY**

These two photos taken by Sigrun Seutemann in the Phillipines show materialization of large lumps of tissue brought about by Tony Agpaoa on a patient from an educated Western culture. The minds of both the patient and the surgeon are involved in the process, according to the psychic surgeons themselves. "Western patients are strongly conditioned to believe that medicine involves bloody tissue, so this is what results in the particular form of the materializations. For native patients who are steeped in the lore of shamanistic medicine, apports may consist of substances such as leaves, coconut fibers, feathers, etc.

The legitimate surgeons, working in a religious group structure, are often able to generate sufficient kindling to fully materialize such unconsciously structured thought forms, and also to dematerialize and rematerialize the tumor from inside the patient's body, the tumor usually appearing or emerging from an opening which appears in the apport tissue. In the surgeon's view he is also being helped by powerful spirits — and continual charging of such thought forms with kindled

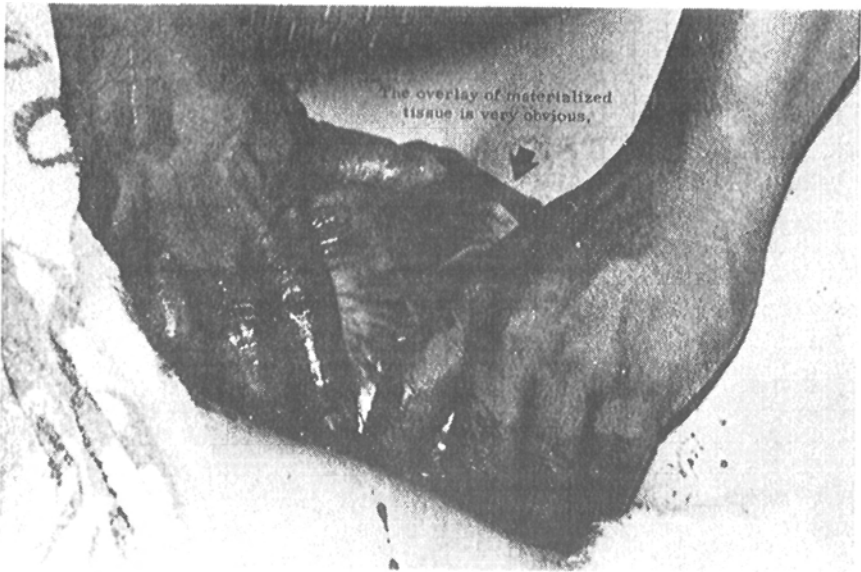

1. Materialization of apport tissue while removing a tumor from the abdomen.



2. Materialization of apport tissue while working in the hip region.

**Photo 32. Psychic surgery.**

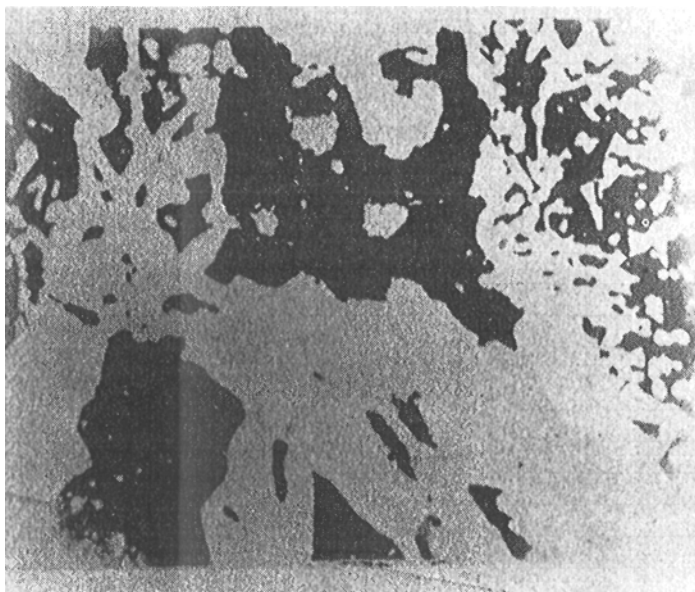

This highly unusual photograph resulted in the following manner: Mrs. Baune is a devoutly religious lady, and on this particular day she had spent a great deal of time in prayer and a Christian attitude. Snow was gently falling on the shrubbery in her yard, and she and a neighbor were admiring the beauty of the fresh snowfall. The neighbor borrowed Mrs. Baune's camera and snapped a photo of the snowfall. When the photo was developed, the falling snow had formed a pattern of Jesus on the shrubbery in Mrs. Baune's yard.

Photo 33. Kindling of thought bioenergy in snow.

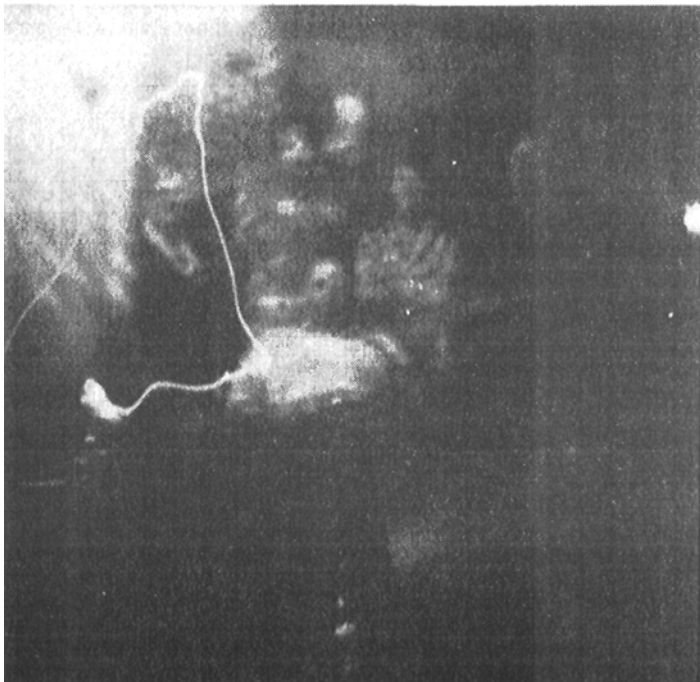
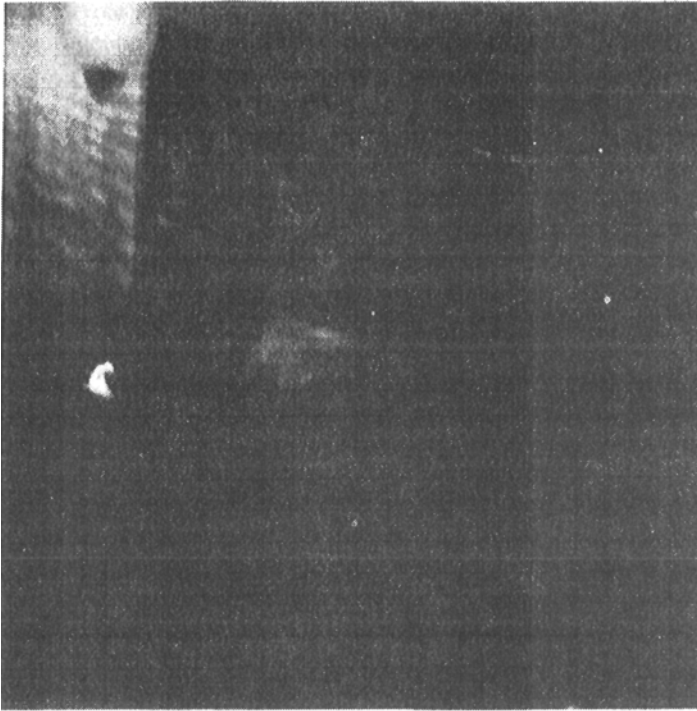

**Photo 34. A deliberate experiment with kindling.**

energy indeed can yield bioenergetic formats of more intense energy than a single talented individual can usually muster in an unaided or unaugmented state. Almost every religion, in fact, still occasionally exhibits miracle healing accomplished in somewhat similar fashion, though possibly less dramatically.

The apport tissue is a materialized tulpoid, precisely as are sasquatch, the yeti, the Loch Ness monster, and UFO's. Apports are normally more stable than these latter materializations — but they have also been known to disappear, as have the "angel hair" apports associated with UFO's.

## **A DELIBERATE EXPERIMENT WITH KINDLING**

I and other members of the American Association of Meta-Science performed a series of experiments in kindling thought or psychic energy into electromagnetic energy, and photographed the resulting light energy on film with an SX-70 camera. The two photos shown here are from one of those experiments. In the left picture, bioenergy is just at the "burst" point where it is being collected on a candle flame. Here the camera lens is not quite fully opened. Only a single 40-watt lamp illuminates the room, and several AAMS members have been engaged in about two hours of psychic exercises. In the second picture, the lens of the camera is fully opened, and a "burst" of kindled energy occurs as the lens shutter is operated. None of this is visible to the naked eye. The polaroid film, however, is sensitive to some infrared and ultraviolet frequencies, so that bioenergy kindling into electromagnetic energy at IR or UV frequency can be photographed even though not seen by the naked eye.

## **FAY CLARK'S "FIREFLIES"**

Fay Clark experimented with an ultrasonic generator in a darkened fallout shelter and photographed the most interesting results. At one particular frequency, dynamic dots of light appeared, grouped themselves into formations, and demonstrated movement and growth. At times they seemed to respond to thought, as if they were somehow intelligent, sentient creatures. This is a beautiful case of kindling using ultrasonic frequencies as the collector mechanism. While Fay is no longer sure of just exactly which frequency produced the fireflies, he does know that he used frequencies in the 38—40 kilohertz region, among others. This may be significant, since the Vestigia experiment encountered electromagnetic frequencies in the same region in their historic study of a mystery light. The frequency region 38—40 kilohertz is a strong candidate for one of the magic window frequencies between bioframes where kindling is much easier than at other frequencies. Furthermore, since it is thought energy or mind that is actually being kindled, one would expect the possibility of sentient behavior. Clark's experiment occurred in the dark, so the squelching effect of visible light was not present. Finally, Fay Clark is a known psychic himself, and so this should have eased the kindling difficulty even further. The value of rigorous laboratory experiments based on the lines of Fay Clark's pioneering "firefly" experiment is strongly indicated.

## "FOO" FIGHTERS

When large groups of people are under strong external pressure, one result is often tulpoidal "popouts" from the collective human unconscious.

A war is a typical example of a situation where the group consciousness of a country is under enormous pressure. In such a situation, the "targeted" population is often exposed to tulpoidal manifestations from time to time.

In World War II, for example, the Germans thought at first that the glowing lights darting around their planes were secret Allied weapons; and the Allies thought the same thing of the Germans when they saw such unusual phenomena. The French dubbed them "feu" (fire) fighters, which became "foo" to American soldiers in Europe.

"Foo" fighters were a common phenomenon in World War II, particularly in cloudy, overcast skies.

## WATER MONSTERS

In the oceans and in every large body of water on earth, water monsters have been reported for centuries. Loch Ness in Scotland is of course one of the most publicized examples, but creatures of different shapes and sizes have been seen in large lakes and streams everywhere. This is not at all surprising when one realizes that a large body of water is a most excellent kindling reservoir, and bioenergetic forms are more readily kindled in such locations.

The large dead creature in photograph 36 was hauled off the bottom of the sea by Japanese fishermen in their nets, photographed, and then thrown back to prevent contamination of the catch of fish and to get rid of the stench from the decaying carcass. It is a pleisosaurlike creature's remains, not similar to anything else known on earth. Predictably, scientists were almost immediately at odds as to what it was, and the carcass has been called a shark, a whale, a large elephant seal, a genuine pleisoaur, etc., by various "experts." Nonetheless it was real and physical, and a good photograph was obtained of it.

Photograph 37 is one of the underwater photographs of the Loch Ness monster taken by a team from the Academy of Applied Science, Boston, Massachusetts on June 20, 1975. As can be seen by a detailed study of the photograph, this tulpoid is not clearly tuned or clearly formed. Many other photos of the Loch Ness monster have been taken, and various shapes and sizes and degrees of tuning have been recorded. In the Doc Shiels photos taken in 1977, Nessie is well formed but entirely different from the Academy photo. Also, Doc Shiels' photo was subjected to computer analysis by Ground Saucer Watch, and the image exhibited a transparency that was disturbing to the analysts. On the other hand, such a transparency is to be expected from a partially materialized tulpoid which is not completely ortho-rotated into the zeroth bioframe.

In the Academy photograph, one can see — particularly on the color original — a form which has several conglomerated faces, which exhibits eyelike structures in several locations to suggest first a cowlike face and then a horselike face, and incoherently tuned earlike and hornlike appendages in several places. In fact, the Academy photo bears little resemblance whatsoever to a pleisosaur or any other more normal and coherently structured mammal or fish.

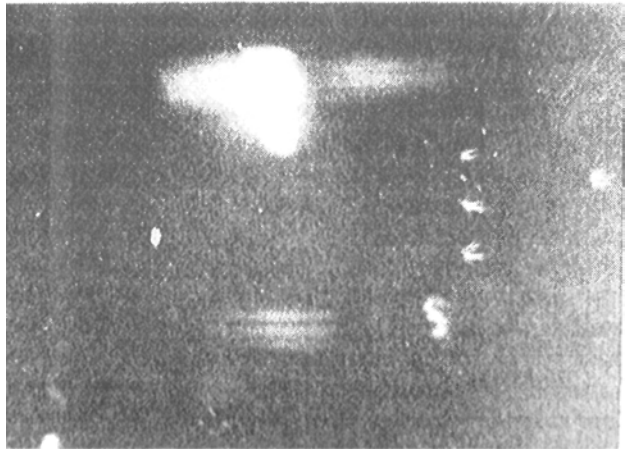
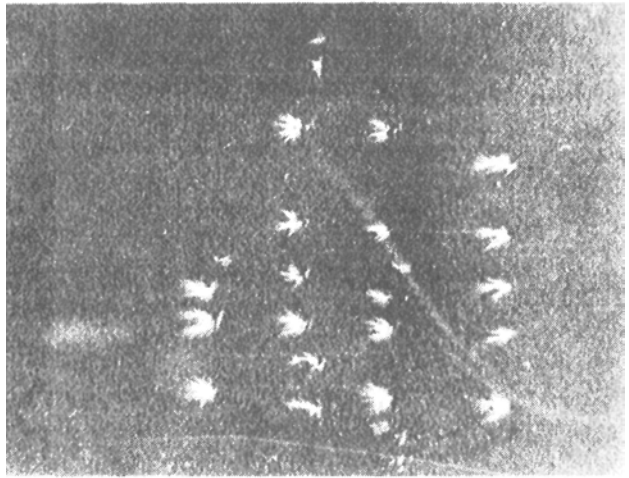
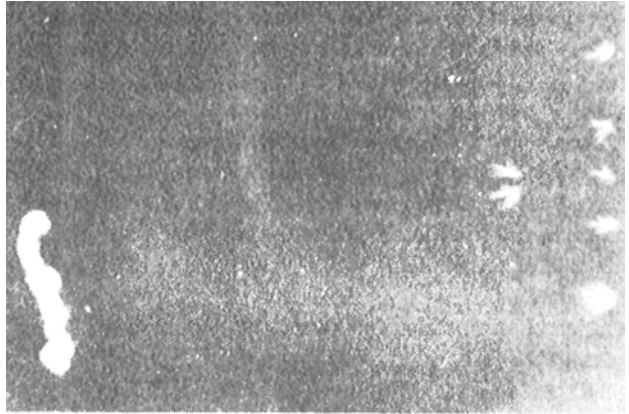
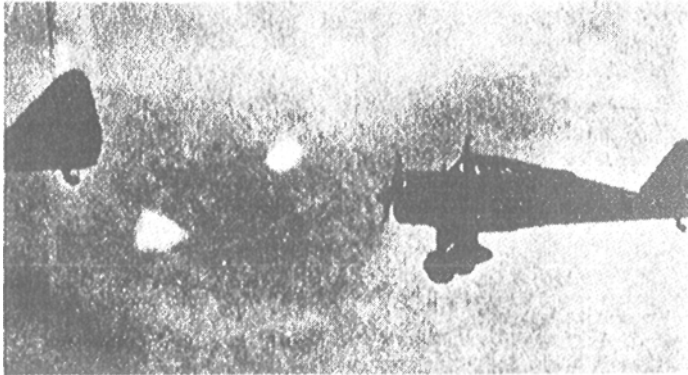
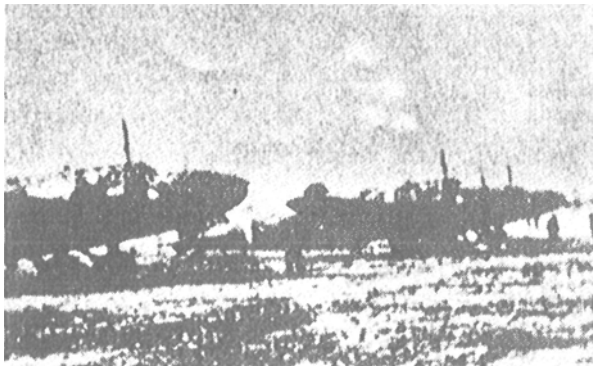

Photo 35. Fay Clark's "fireflies."



"Foo fighter" tulpoids pacing Allied aircraft in World War II.



"Foo fighter" tulpoids over an airfield in China in World War II.

**Photo 36. "Foo" fighters.**





Photo 37. Pleisosaur-like creature hauled from the sea by Japanese fisherman.

The Loch Ness monster is definitely a tulpoidal form, and the format varies appreciably from reception to reception due to distortions and variations in tuning. *Nessiteras rhombopteryx* is a much stranger beast than anything the dedicated Nessie seekers, researchers, and scientists have yet suspected. In Part Two I will examine the scientific basis of tulpoidal forms.

## **CATTLE MUTILATIONS**

Over 9,000 cattle mutilations have occurred in the U.S. alone since 1973.

The cow is a female symbol par excellence — our children drink cow's milk, and our babies feed on the milk from the cow's breast. The U.S., being a natural fortress, is a "female" symbol, for in primitive human evolution the females stayed in the cave or protected fortress while the males went forth to hunt or do battle. (This symbolism will be fully discussed in Part Three.) Violation of the female means that the heartland U.S. shall be violated.

Teats are cut off — the children of the West shall lose their sustenance; lips, ears, and tongues are removed — freedom of speech and hearing shall be excised; sexual organs are removed — no more fruit of the womb shall be evidenced in the West; sharp, surgical incisions are made — the operation shall be accomplished swiftly (blitzkrieg war) with surgical precision; zig-zag cuts — deception shall be used as to direction and intent; blood is totally drained — the lifeblood of the West shall be totally drained; edges of the cuts are often seared as if by a laser — advanced, futuristic weaponry (psychotronic weapons) shall "seal the end." The cattle mutilations are materialized precognitive nightmares indicating the horror of the Armageddon to come, and these nightmarish paranormal mutilations reveal the true nature of the times. Yet no orthodox scientist or governmental agency is equipped or able to deal with a phenomenon such as this.

In ancient times the wise men knew how to do a metapsychological analysis of the species unconscious, and knew that tulpoidal phenomena were often symbolic signs of that which was to come.

Where are our wise men today?

## **BIG MAMA**

UFO phenomena have also been associated with the cattle mutilations. One of these UFO-type tulpoids has been labelled Big Mama, because of its characteristic behavior of spawning smaller UFO light-shapes that split away and speed off to an area in which a cattle mutilation then occurs. The "spawned" UFO's then return and link up or join with Big Mama, and Big Mama then withdraws.

The photo shown here is a typical appearance of Big Mama. Big Mama takes many sizes and shapes, but is a fairly reliable indicator of paranormal cattle mutilations impending.

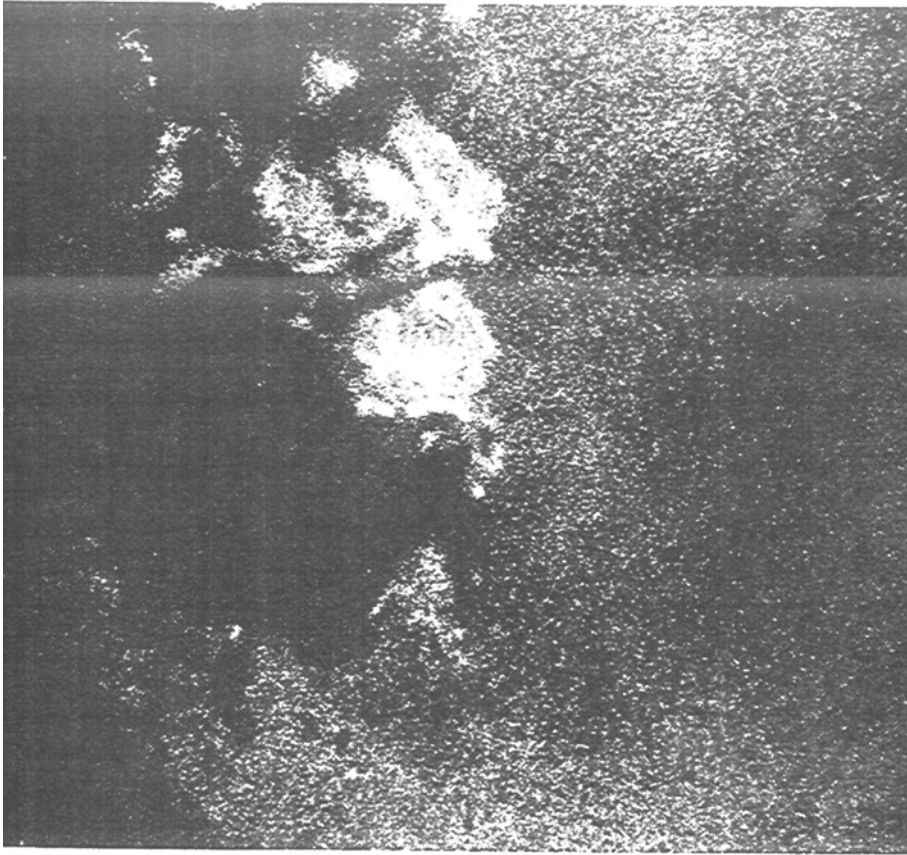
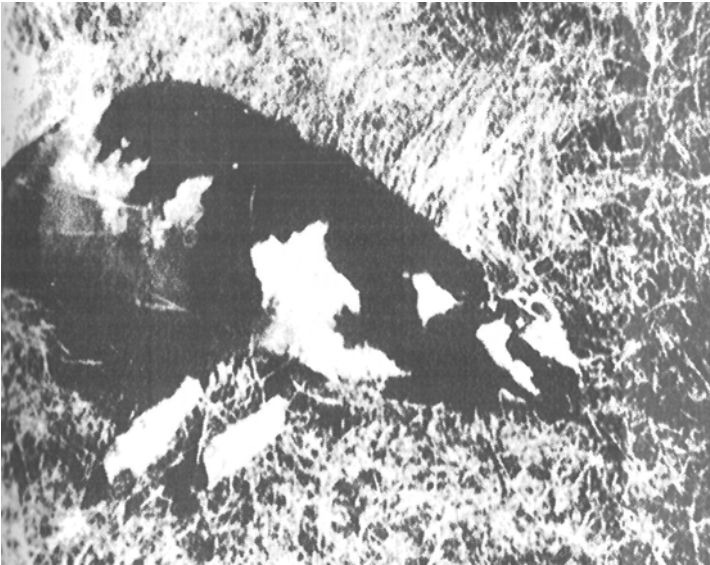
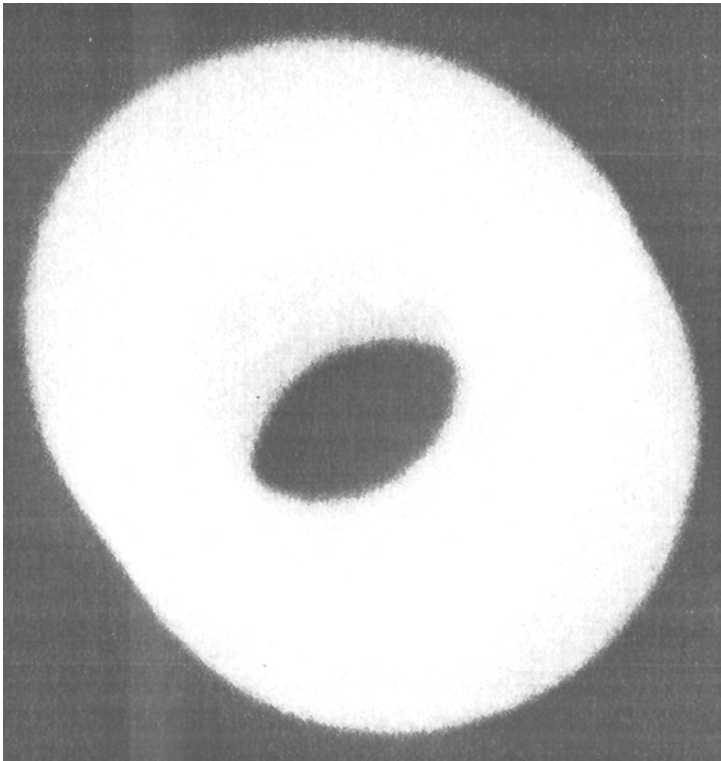

Photo 38. Loch Ness monster.



**Photo 39. Cattle mutilation.**

During the summer of 1978, two psychics and I — all members of the American Association of Meta-Science spotted a Big Mama-type UFO from the top floor of a hotel in Louisville, Kentucky. Realizing what it was, we promptly brought into play a certain type of powerful psychic exercise and tried to make it dematerialize and vanish. Several times it briefly split into pieces (five to be precise), but we were unable to extinguish it. Over a period of approximately twenty **minutes** this effort continued, and all the while Big Mama slowly moved lower and **further** away, eventually disappearing behind a tall building after having become very distant.



**Photo 40. Big Mama.**

**PART TWO**

**A THEORETICAL  
BACKGROUND FOR  
UNDERSTANDING PT,  
UFO'S, AND PSI  
PHENOMENA**

Footnote for page 132:

'With the exception that, in my theory, the orthogonal universes crosstalk with each other at virtual (subquantum) levels. Indeed, 'change' in one universe consists of the quantum coherence in that universe of crosstalk in and out of it. The 'virtual state' in one universe is due to, and consists of, subquantally coherent (quantally incoherent) crosstalk in and out of that universe.

Psychotronics, unidentified flying objects (UFO's), and paranormal phenomena such as psychokinesis, telepathy, and precognition all have one thing in common: both mind and matter-energy are involved.

Hitherto, mainstream science has insisted on a rather arbitrary separation of mind and matter-energy. However, as we shall see, this separation is not based on good observation. For example, everyone exhibits in himself the ability of mind to affect matter. While theories of computers, control systems, and physics can explain human behavior once the physical system has been given an input signal, the original signal — intent, or what I call inception — is an unexplained mystery to ordinary science.

"Psychotronics" (a Czechoslovakian term) and "psychoenergetics" (a Soviet term) have been specifically designed to provide a framework for approaching the problems of mind, matter, and their interaction. If we can understand psychotronics, we will be able to understand better the interaction of mind and matter, including all paranormal phenomena, unidentified flying objects, and Fortean phenomena.

Let us therefore start by defining psychotronics. The prefix "psycho" refers to the mind. The suffix "tronics" refers to physics and physical devices. Thus the concept of psychotronics refers to a union of physics and metaphysics. Such an audacious concept can offer a solution to almost every present problem in metaphysics, the foundations of logic, the foundations of physics, and the foundations of mathematics.

To begin with, it seems necessary to form a unified theory of mind, matter, and their interaction. It also seems necessary to reinterpret and extend electromagnetic theory. Logic itself must be advanced, for a part of reality, although "illogical" according to our present logic, is nonetheless true. In metaphysics we must solve formidable problems: the ontological problem (nature of being); the problem of mind, and the interaction of mind and body; the problem of change; and the problem of nothing.

It has been said that fools rush in where angels fear to tread. To tackle the problems of psychotronics demands the audacity to rush in where even fools fear to tread!

At this time, it may be appropriate to point out that all Western science, mathematics, and logic are founded upon three simple laws of logic, proposed and formulated by Aristotle. Since the entire universe cannot be described by these three laws — parts of reality are known to violate one or more of them and hence be illogical though true — it appears that we must be audacious enough to tackle and change the three laws of logic, if a new paradigm is to be constructed to solve all the presently unsolved problems.

## SOME UNEXPLAINED MYSTERIES OF PHYSICS

First, no one knows what mass really is; we do not know for sure whether inertial and gravitational mass are one and the same. General relativity says it is, **and** we know from experiments that if any difference exists between inertial mass **and** gravitational mass that difference is very small indeed. But we do not know positively that there is not some small but finite difference. And we have no idea



why the mass of a moving object increases with respect to a static observer. It is simple to calculate in special relativity how much the mass increases as a function of the velocity, but no one has the foggiest notion why this happens. Particularly so since an observer standing on the moving object and moving along with it sees no increase in its mass at all.

This poses a real paradox; if we try to assign some absolute notion to the idea of mass, then any object has an infinite number of masses, all at the same time and all different. There are two ways to determine mass: (1) by its resistance to a disturbing force, and (2) by its ability to occupy three-dimensional space. The latter requires that mass be volumetric, i.e., that mass be  $L^3$  dimensionally.

But look at the weird properties of a photon! If we measure its resistance to a disturbing force, we find that no force on earth can accelerate or decelerate the photon. If we measure the mass of a photon by the first method, it appears to have infinite mass. Yet if we measure it by the second method, it can have no mass at all, because a photon is not volumetric; it is two-dimensional. It therefore has infinite mass and zero mass simultaneously.

Furthermore, we can take the viewpoint that whatever its mass is, it can only have one. If that is so, then infinite mass and zero mass must somehow be the same thing! Which contradicts the three laws of logic. However, this should not concern us too greatly; many things contradict the laws of logic and are nonetheless true. So while it is presently "illogical" for infinite mass and zero mass to be identical, we should hold on to the idea that this may very well be true.

Additionally, one of the great cornerstone assumptions in physics is that gravitational field and electric field are mutually exclusive — i.e., they are totally different things. Yet a physicist named Santilli has proved that this is not so, and that they are either partially the same thing or totally the same thing. And there the matter stands, so we do not fully understand what electric field and gravitational field are, or how to go about turning one into the other, although Santilli's work seems to imply that this is at least theoretically possible. We must therefore invoke a new concept of reality.

## URI GELLER

Uri Geller has demonstrated numerous capabilities: he has affected a magnetometer inside a Faraday shield; bent and broken metal objects; caused a fresh flower to wither and dry in seconds; permanently changed the crystal structure of nitinol; altered magnetic programs on computer cards; influenced a Geiger counter; dematerialized matter; and demonstrated the inceptive Cyborg effect, thought-photography, telepathy, and the Geller effect (the sympathetic stimulation of a psi-positive).

It is useless to attempt to explain the feats performed by Uri Geller in terms of the ordinary fields and effects of known physics. Nothing short of a new physics paradigm will suffice. This new paradigm must encompass both mind and physics within the same theoretical framework, if it is to succeed in explaining how mind affects matter.

In terms of present physics and logic, the mind is regarded as totally separate from matter. For mind and matter to interact, some aspect of mind must be the same as some aspect of matter, i.e., to move matter, a force is required. Force is the time rate of change of momentum. To generate a force capable of moving matter, mind must be able to change momentum. But since momentum can only be obtained from something which possesses momentum to give up, then the mind must somehow possess momentum.

If this is so, then the momentum must ordinarily exist in a separate three-dimensional space, since it apparently does not ordinarily exist in laboratory three-dimensional space. Such a situation requires at least six spatial dimensions and one common time dimension, such that the mind (mental phenomena) is a set of objective physical phenomena existing in an ordinary objective three-dimensional space, but one which is three orthogonalities away, spatially, from the laboratory three-dimensional space.

Mental changes upon physical objects would thus imply orthogonal rotation of mental objects from the mental three-dimensional space into or closer to the laboratory three-dimensional space. Everett's many-worlds interpretation (MWI) of quantum mechanics contains a structure where such representation is possible, and the MWI is consistent with the entire experimental basis of modern physics. Thus from the MWI it is possible to objectively model the mind and matter, and from that, psychotronics as well.

## MY APPROACH TO PSYCHOTRONICS

In twelve years of intensive work on this question, I have evolved a conceptual approach, which is consistent with present physics but extends it. A new concept of reality is involved, however, and severe demands are made on the individual to stretch his framework of comprehension. The perceptron concept is an abstraction that allows the modeling of perception itself—either mental perception or physical detection. The fourth law of logic (to be explained shortly) involves the age-old identity of opposites whose apparent necessity has baffled logicians, philosophers, and scientists for centuries. With the perceptron concept, we can at last comprehend how the identity of opposites is accomplished, and when it is accomplished.

This immediately solves the age-old philosophical problem of change. The fourth law also closes logic into a complete, closed metalogic, encompassing both physics and metaphysics.

Let us use as a definition of reality: *reality is that which can be conceptually and mathematically modeled and fitted to the phenomena existing in one or more minds*. Physical reality is that which can be modeled and fitted to the phenomena existing in all minds. Mental reality can be modeled and fitted to the phenomena in one mind. Mental and physical realities comprise "normal" reality. Complex or "paranormal" reality is that which can be conceptually and mathematically modeled and fitted to phenomena which exist in more than one mind, but not in all minds.

From perception theory I have succeeded in deriving a great deal of the present basis of physics, including Einstein's two postulates, Newton's laws, the law of gravitation, and the solution to the ontological problem. (Unknown to me at the time, Ives had already done so for Newton's laws, the law of gravitation, and Ein-

stein's postulates. His work has unfortunately been ignored.) In addition, the photon can be seen to be an ordinary three-dimensional particle existing in a three-dimensional space that is orthogonal to the laboratory three-dimensional space frame. A stationary particle in the laboratory frame appears as a photon to the orthogonal spatial frame.

Einstein's second postulate is usually stated as "the speed of light is the same for every observer." Restated, this becomes "every photon in an inertial frame is moving at the speed of light,  $c$ , with respect to every particle in that inertial frame." The corollary then follows immediately: every particle in that inertial frame is also moving at the speed of light,  $c$ , with respect to every photon in that inertial frame. In a single three-dimensional space, this is incomprehensible. Taking two orthogonal three-dimensional spaces, with the photons in one frame and the electrons in the other, it is perfectly comprehensible.

From pure nothing — empty vacuum, absence of thing — one can generate everything, the presence of thing. Here is direct proof that ultimately opposites are identical. But to a mind rigidly programmed in three-law logic, such a truth is abhorrent. Physicists consequently have done nothing with the idea that all our physical laws — or at least most of the great ones — can be straightforwardly derived from a special kind of a "piece of nothing" which I call a quiton. And they have not seen that this constitutes a statement of a fourth law of logic—the identity of opposites on their common boundary.

It is interesting to note that the paper which was handed to an American reporter, Robert Toth, by a Soviet scientist, and which caused the KGB to seize Toth and charge him with receiving Soviet state secrets, contained just such a theory as the basis of a unifying theory of psychotronics. Yet none of our intelligence analysts seems to have picked up the overwhelming importance of what was in the paper, and Toth himself appears to believe that his KGB arrest was simply harassment. In fact the paper did contain material on the basic Soviet approach to psychotronics — and thus to psychotronic weapons — and it was indeed state secrets that had been given to Toth.

Everett's many-worlds interpretation of quantum mechanics, with which very few physicists are familiar, provides a needed correction to the conventional monocular interpretation of relativity, and it allows a theoretically sound basis to be constructed for psychotronics.

The conventional interpretation of relativity considers only a single observer at a time. But if you can accept so simple a concept as that both you and I exist simultaneously, regardless of how we move with respect to each other, then I assure you that physics is startlingly different from what you may have studied in the ordinary university physics text book.

Everett, originally a student of the world-renowned physicist Dr. John Wheeler at Princeton, for his Ph.D. thesis considered the problem of multiple simultaneous observers and worked out what this did to physics. His highly innovative thesis provided a totally new interpretation of quantum physics and defined a startling new kind of reality in which all possibilities are physically real and exist. This new physics is indeed very strange, but it is totally consistent with the entire experimental basis of physics today.

I discovered that all my perception theory could be fitted precisely onto Everett's many-worlds interpretation.<sup>1</sup> On that basis, a theory or schema of bio-

fields was derived that provides an approach to a unified field theory. In fact, it predicts that any kind of field can be turned into any other kind of field, merely by correct and precise time synchronization. It also offers a physical and exact model of mind and mental phenomena and a mental and exact model of physical phenomena!

On this basis, a framework can be provided for psychotronics which is consistent with what we know of ordinary physics but which does not contain many of the limitations of ordinary physics. In a strange sense Everett wrote the physics for the all-mind or the Supreme Creator's mind because an unlimited mind, so to speak, must already have thought of everything possible, and for an all-creative mind to "think" a possibility is for that possibility to be real.



**Fig. 3. Reality: a paranormal bridge with two ends**

## 1. Reality as a Paranormal Bridge with Two Ends

In Figure 3, I show the nature of the problem of paranormal phenomena. To understand it, we must first define more precisely some of the present concepts.

First, what do we really mean when we talk of "physical phenomena"? To go into this, we must first destroy the notion that there exists some sort of separate, concrete reality totally apart from mind, for that notion is simply the old Cartesian assumption. It has long been refuted as far as having any absolute validity, and this is well-known to philosophers and to foundations physicists. According to Lindsay and Margenau in their *Foundations of Physics*, "physics has nothing to say about a possible real world lying behind experience."

What is true is that we can experience and detect and know only a mental change — a change in the mind itself is all we ever experience directly. For experience invokes the mind; we do not experience phenomena until the mind — used in the greater sense of the word to mean any mental detection — changes.

Any detector detects or experiences only an internal change, never an external change, and this is true of the mind as well as a physical detector.

So we never experience external physical phenomena; we experience only our own minds. Specifically, each of us experiences his own mental phenomena.

But here we must be a little more precise about what we mean by "mental phenomena." What we usually refer to are the mental phenomena in a single mind. And so we will take that as the primary definition: *mental phenomena are the phenomena or changes in a single mind.*

But then what do we mean by "physical phenomena"? For indeed this refers to something that is often remarkably different — or seems to be — from the phenomena or changes going on in our own heads. Before we jump to the extreme conclusion that physical phenomena are simply mental illusions, we should recall the Zen master's approach. He demanded of the student whether or not physical phenomena were real, and the student replied that they were not real, but only illusions. Whereupon the master gave him a resounding knock on the head, and asked him whether or not the blow was real. The student replied that the blow was indeed real. Whereupon the master sent him back for further meditation, for he had learned nothing. He had not understood that "mental" and "physical" are not mutually exclusive.

If we look closely at how we may differentiate between mental phenomena and physical phenomena, we immediately hit upon a practical scheme. Physical phenomena can be shown to exist in the mind of any observer, be he human, insect, or whatever, so long as he has consciousness.

Suppose for a moment that I have a piece of chalk in my hand, held between my fingers. I can touch the chalk, feel it, and see it. I can even taste it if I wish. And so I hold up the piece of chalk and say: "This piece of chalk is not just a mental impression, it is physically real." How can I prove it? And when I prove it, what exactly have I proved?

Now suppose you do not wish to believe the chalk is real. You simply bring in another observer; he looks at the chalk, he touches it, he tastes it, and he rolls it between his fingertips. He confirms that he also detects or experiences the chalk. Then a little bug flies in and lands on the chalk, crawling around on it, and poking at it with his little proboscis. He also by his actions confirms that he has it in his own little mind. In fact, we could bring in any sort of mind, and that mind could experience the chalk.

And this of course is the clue. What we have been calling physical phenomena can be shown to exist in every mind. And when we say something is physically real, this is all we actually mean. Nothing more, nothing less. And this is why physical phenomena are so solid and concrete; they are infinitely repeated. However, what we refer to as mental phenomena are in only one single mind and thus are not repeated at all.

Now let us do a little thought experiment. Suppose I have lapsed into some peculiar mental state because of the toxins from an infection I have contracted, and I am hallucinating vividly. Suppose I pick up what I vividly see, feel, touch, and taste as a piece of chalk, and I claim that it is real. Indeed, to me it is very real. And then suppose a second person comes into the room. He will not see the chalk, touch it, feel it, taste it, and it will not be real to him. Then suppose a third person comes into the room, and he does not see the chalk, he passes his fingers right through where I am seeing the chalk and does not contact or feel it, and he indeed cannot find it. Thus what we call a "mental phenomenon" can be shown to exist in one mind only. In this case of a vivid hallucination, the hallucinatory phenomenon was absent from the other observers' minds.

But now let us change our thought experiment a little. Suppose now that I am absolutely fit and fine physically and mentally, and am not hallucinating. And suppose all the observers we bring in are also fine both physically and mentally, and not hallucinating. And suppose we get the following results: some of us can see,

touch, taste, and experience the chalk, and others of us cannot see, touch, taste, or experience it, no matter how we try. In that case, what kind of phenomenon do we have?

Well, we cannot exactly say the phenomenon is exclusively mental or exclusively physical. But we also cannot say that it is exclusively nonmental or exclusively nonphysical. In fact, we have an example of a third class of phenomena which are presently not recognized by science. *We simply have a paranormal phenomenon*, one which can be shown to violate our definitions of mental phenomena and physical phenomena.

And we can in fact take this as the definition of a paranormal phenomenon: *a paranormal phenomenon can be shown to exist in more than one mind, and it can also be shown not to exist in one or more minds, i.e., paranormal phenomena exist in more than one mind, but not in all minds.* Our conventional science recognizes purely mental phenomena and purely physical phenomena; it does not recognize the third kind, since by the ordinary three laws of logic the third kind does not exist. Paranormal phenomena constitute a bridge across a river between two banks; our present science does not recognize the bridge, but only recognizes the two banks, as shown in Figure 3.

Paranormal phenomena thus appear erratic to ordinary objective science, for objective method after all is specifically designed to select only those phenomena that can be reliably repeated, and the nature of paranormal phenomena is such that they often (in fact usually) cannot be reliably repeated, except sometimes in a great many trials. Normal objective method, if rigorously applied, can only discriminate a statistical effect from a great many trials. Furthermore, if rigorously and lengthily applied, it will accumulate so many failures that it will cast serious doubt on whether the odd case that was paranormal was in fact nonaccidental.

It is for this very reason that orthodox science, which is devoted to scientific method and rigorous protocol, has remained so comfortably adamant that paranormal phenomena do not exist. The tool must be changed to fit the problem, and the present scientific toolbag does not fit precisely. The tools are useful, but they themselves are not decisive within the bounds of present protocol. The necessary change is quite simple: we must allow for the effects of mind, and for a union of both mind and physics, just as there exists in physics a union of both wave and particle. In other words, paranormal phenomena must be repeatable *sometimes*, by competent experimenters and observers, but not necessarily *always* by all observers.

"Ah ha!" the materialist is likely to exclaim, being unable to contain himself any longer. "Solid concrete reality always is solid and concrete, however, and you cannot change that. As long as that is true, then the laws of ordinary physics hold, and all is right with the universe. We can always select our phenomena which are present in all minds, and this after all constitutes immutable physical reality. In the face of that fact, all your arguments about mental phenomena in one mind and another kind of half-mental, half-physical phenomena are meaningless, for you are simply calling the superposition of purely mental phenomena on purely physical phenomena a third class, but it is a separable mixture, not a completely new kind." And we may even be tempted to stir up a small bit of sympathy for the materialist's view.

However, let us propose a resolution. If we can show that concrete, solid, real

matter can become absolutely nonconcrete, nonsolid, and hence nonphysical, then that ought to settle the question. In a recent experiment it has been conclusively shown that two colliding protons pass right through each other in total violation of all physical rules, if their spins are exactly antiparallel. Protons are the central building blocks of all matter. In the nucleus of an atom, the protons and neutrons are continually switching identities, so even a neutron keeps turning into a proton, etc. And these fundamental constituents of everything solid and concrete and real just go right through one another, without any effect whatsoever, simply by aligning their spins properly. Collision theory fails, electromagnetic theory fails, and our concept of two particles bumping together fails. This experiment totally annihilates the idea that physical reality is something absolute. In fact, it establishes that physical reality itself is a function of the relations between the interacting participants; changing the relationships can simply cancel physical reality.

So perhaps our definition of physical reality has some merit after all, and perhaps there really are three classes of phenomena. The paranormal phenomenon is a bridge between mental and physical phenomena; specifically, every paranormal phenomenon must consist of an inseparably welded compound of the two. And the objective method and its consequent experimental protocol must be changed to reflect this fact, if we are ever to develop a viable theory of paranormal phenomena.

## 2. A Fundamental Correction to Classical Logic

Let us now make a fundamental correction to Aristotle's three laws of logic. First, there is no independent existence to mental phenomena; there is a perception operation involved when we think. There is no independent existence to physical phenomena; there is a perception operation involved when we observe physical phenomena. Furthermore, it takes a finite piece of time for the perception process to occur. The logic symbol also requires a separate time interval; it represents a series of separately perceived operations that together comprise a decision algorithm. So let us impose this criterion upon logic itself so as to constitute "logical perception" or the "logic of perception" or the "perception of logic." We begin with Aristotle's third law of logic,  $A$  or  $not-A$ , the law of the excluded middle.

We still insist that there is no such thing as  $A$  per se, but rather that there is a perceived  $A$  where  $A$  is the output of the perception process. Similarly, there is no such thing as  $not-A$ , but rather there is a perceived  $not-A$  where  $not-A$  is the output of the perception process. Let us think of a square box symbol as an abbreviation for the fact that perception has occurred, and anything written inside the box represents the output of that perception operation. We can speak of the box either as mental perception, a description of thought, or we can speak of it as physical detection, a description of an instrumentation system that detects and measures. Also, since each box requires a finite time to occur, we must carefully keep up with the individual little pieces of time, the delta  $t$ 's.

So applying this to Aristotle's third law, we have  $A$  perceived or outputted in time one, and  $not-A$  outputted in time two. Note that to ascertain that  $A_1$  and  $not-A_2$  actually differ requires a series of operations in a separate time interval, in time three, that is assumed by the *exclusive* or symbol. Looked at in this way, Aristotle's third law actually is the law of monocularity; it states that only one thing at a time is perceived. Actually we had assumed this when we assumed that perception was a

1.  $A \vee \bar{A}$  ARISTOTLE'S LAW OF THE EXCLUDED MIDDLE
2. DEFINE  $\square$  AS "IS PERCEIVED"
3.  $\square A \vee \square \bar{A}$  LAW OF THE EXCLUDED MIDDLE
4. EACH PERCEPTION IS A FINITE OPERATION AND REQUIRES A FINITE TIME TO OCCUR.  
THE LOGIC SYMBOL ALSO REPRESENTS A DECISION ALGORITHM: A SERIES OF OPERATIONS PERFORMED IN A SEPARATE TIME INTERVAL.  
EACH FINITE TIME INTERVAL MUST BE ACCOUNTED FOR.
5.  $\square A_1 \vee_3 \square \bar{A}_2$
6. THE LAW STATES THAT PERCEPTION IS A MONOCULAR PROCESS IN TIME 3.  
ONLY ONE-THING-AT-A-TIME IS PERCEIVED.
7. NOW NOTE THAT SEPARATION OF A AND  $\bar{A}$  DOES NOT OCCUR IN
 
$$\square (A_1, \bar{A}_2)_3 \equiv_5 \square B_4$$
8. SO  $A_1 \equiv_3 \bar{A}_2$   $\left| \begin{array}{l} \text{BOUNDARY IDENTITY OF EXACT OPPOSITES} \\ 4,5 \end{array} \right.$
9. AND EQUATION 8 CONSTITUTES A FOURTH LAW OF LOGICAL THOUGHT.  
IT SIMPLY STATES THAT PERCEPTION THREE IS BINOCULAR, AND EXCLUSIVE SEPARATION OF EITHER A OR  $\bar{A}$  IS NOT PERMITTED.

**Fig. 4. A fundamental correction to classical logic**



finite process, so it is nice to find that Aristotle's third law justifies our assumption, once we understand the third law. The *exclusive or* symbol assumes a third operation in time three, whereby it is determined that perception output one and output two actually differ. But such an operation itself requires multicocular perception — i.e., collecting two outputs at once — and that in itself is a violation of Aristotle's third law. The third law thus contains its own contradiction, and indeed each of the other two laws also contradicts the third law when one examines them meticulously. Each can only be established as true by invoking or involving an operation wherein the third law is not true.

In time three we gathered up what had been perception output in time one,  $A_1$  and what had been perception output in time two,  $A_2$ , which we do not yet know is different from  $A_1$ , and put them both through the perception process, getting only one output — let us call it  $B$  — in time four. By the nature of  $B$  in time four, we thus say in time five that the outputs in times one and two differ or not. In either time one or time two, there is no indication whatsoever of difference or sameness existing between output one and output two. Likewise, in time three there is no separate output one and output two, hence no indication of the sameness of, or difference between, outputs one and two.

So here we have arrived at the identity of opposites. There is no perception of difference between  $A_1$  and *not- $A_2$*  in time three. And this constitutes a fourth law of logic: the law of the boundary, or the boundary identity of exact opposites. All that is necessary to identify opposites is to lose all perceptual distinction between them. And that is accomplished by multicocular perception, of perceiving the presence of both at once unseparated, hence the absence of either exclusively present. If  $A_1$  and  $A_2$  are exact opposites, then  $B_4 = O$ , and  $[A_1, A_2]_3 = O$ . We thus have the solution to the problem of nothing. Nothing simply consists of the presence of the totality of all opposites.

Almost all the philosophers who have struggled with the problems of being, mind, and matter have faced the necessity for the identity of opposites, but none of them could understand how opposites could be identified. By careful accounting of the separate time intervals required for finite monocular perceptions, the mechanism for identifying opposites is immediately clarified and revealed. The laws of logic are simply laws of the operation of perception — nothing more, nothing less.

The new system of logic is closed. All present paradoxes — contradictions of one or more of the first three laws — are resolved by the fourth law, which contains the negation of each of the first three laws. The fourth law is in fact the law of the paradox. Note also that the hidden time-three operation, which has actually been the application of the fourth law all along, is implied in each of the first three laws. Identity or nonidentity between time-one and time-two outputs can only be established in a time-three operation. The fact that either  $A$  or *not- $A$*  exclusively exists can only be established by a separate operation which establishes that nothing else is there. If separation of  $A$  and *not- $A$*  is not permitted, then  $A$  and *not- $A$*  cannot be distinguished.

Since these laws refer to perceptual operations, one can think of them operationally, or vectorially. To close the vectorial system prescribed by the first three laws, the opposite or negation of each of the three vectorial statements must be present, i.e., this follows simply from the definition of what constitutes a closed system, vectorially speaking. Since the fourth law contains the negation of each of

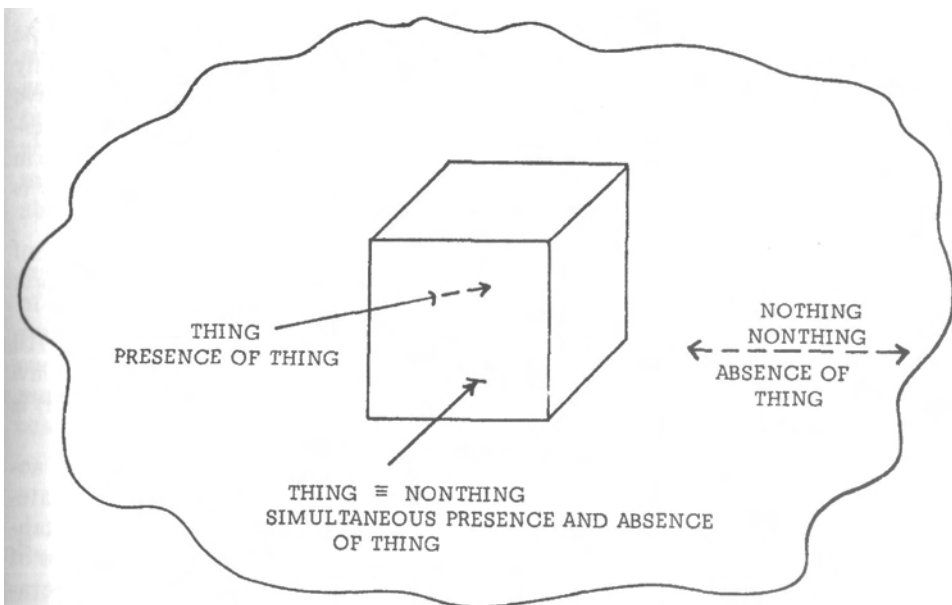

**Fig. 5. A physical example**

the first three laws, then the four-law system is indeed closed, and the logician's dream of a closed metalogic is realized. Furthermore, anything which contradicts any combination of the first three laws automatically is covered by the fourth law, which is the law of the paradox.

The new logic works as follows: either the first three laws apply (separation of *A* and *not-A* is permitted), or the fourth law applies (separation of *A* and *not-A* is not permitted). The fourth law applies only to — and in fact *creates* — a boundary. The first three laws apply only away from a boundary.

### 3. A Physical Example

Take the surface of a cube in deep space (Fig. 5). Call the cube "thing," a three-dimensional concept. Call the empty space around the cube "nothing," a three-dimensional nothing or absence of thing. If we are standing inside the cube and look at its boundary surface, we cannot find a single piece of that boundary surface that does not belong totally to the cube. So we can very reasonably proclaim that by the first three laws of logic each piece of the boundary belongs totally to the cube, to "thing." But if in a different operation we are standing outside the cube, we cannot find a single piece of that boundary surface that does not belong entirely to the space surrounding the cube. So in this case, we can claim by the first three laws of logic that the boundary surface belongs totally to "nothing."

Then in a third operation we can state that, by the first law of logic, each and every piece of the boundary surface is identical to itself, and of course we thereby identify what was thing with what was nothing. Specifically, what was thing in perception time one and what was nothing in perception time two have been

identified, by all distinction and separation between them being removed, in time three. Identifying opposites simply consists of "packing together" two previously separated perceptions into a single third unseparated perception. And all we have done is apply the fourth law of logic, the law of the boundary. Every single perceived thing has a boundary, where it both begins and ends its exclusive presence in perception output. And at that boundary, the fourth law applies. Thus the law is universal. The fourth law defines a boundary.

In fact, in any perception, all four laws are applied. They are applied in one of two fashions: (1) the first three are explicit and the fourth implicit, or (2) the first three are implicit and the fourth explicit.

There are more examples that have baffled mathematicians and logicians. All of these are simply boundary statements, i.e., statements involving the fourth law of logic. For example: "It is true that this statement is false"; "A line (length) is composed of points (nonlengths)"; "In a hologram, each part is the whole."

Since logicians used only the first three laws, none of these statements was acceptable or understandable. By the fourth law, there is no problem with these statements. The first merely refers to the boundary between the operation used to establish "truth" and the operation used to establish "falsity." There is another class of operation where neither truth nor falsity exclusively applies — i.e., a class of operation which cannot distinguish between "true" and "false."

The second statement has long been a painful trauma to logicians and foundations mathematicians. Today foundations mathematicians seldom attempt to define line or point. Instead, they simply say: "There is a class of entities called lines. There is a class of entities called points. Lines are made up of an infinite number of points." This way, they avoid trying to explain how "length" (line) can be made up of "nonlength" (points).

However, they could easily have avoided the difficulty, and still retained the definition of a line as a length, and a point as a nonlength, in the following manner. "There is a class of entities called lines. A line is and has length. There is a class of entities called points. A point is and has nonlength. We may have a separate perception that shows nonlength, and another separate perception that shows length. In yet a third perception which infolds both the first two perceptual characteristics, we may say that a line is comprised of points so long as we realize that line and point do not separately and exclusively exist in the comprised-of state."

By the same token, we can say that "the whole is comprised of the sum of the parts" only if we realize that "whole" and "part" do not separately and exclusively exist in the comprised-of state, but instead they inseparably and nonexclusively exist therein.

## 4. New Definition of Zero

To a monocular perception process, multiple presence constitutes absence of the exclusive presence of any particular one. Therefore such a multiple presence is monocularly unperceivable, and hence becomes a zero to a monocular detection process. This allows new definitions of zero, and a solution to the problem of nothing.

Consider that a monocular detection process asks the question, "Is there a single exclusive thing present in my input?" If the answer is yes, an output is generated and perception occurs. If the answer is no, no output is generated and perception does not occur. The answer "no" occurs in two fashions: either total absence, or presence of two or more simultaneously. For either of these cases, monocular perception gives no output, and perception does not occur, i.e., the absence of perception occurs.

Now note that the monocular perception cannot tell any difference in the two input conditions. To it, there is no distinction between the two conditions. The lack of any difference at all constitutes identity. Thus to a monocular perception process, condition one is identical to condition two when they are infolded together in condition three. That in fact derives the fourth law of logic. Total absence and multiple, unseparated presence are identical insofar as a monocular detection process is concerned.

## 5. Einstein's Postulate

As an example of strange problems we can deal with in a four-law manner, let us examine a little more closely one of Einstein's postulates of special relativity, which states that the speed of light is the same for every observer. Let us restate the postulate as "every photon is moving at the same speed relative to every particle." We can pick any electron in the laboratory frame. Every photon in the frame is moving at the speed of light with respect to the electron, by Einstein's postulate. Now let us pick any photon. By Einstein's postulate, every electron is also moving at the speed of light with respect to this photon.

Now we can look at the situation from the viewpoint of the photon. With respect to it, every electron in the laboratory frame is moving at the speed of light, which violates the common interpretation that ordinary objects cannot move at the speed of light. In fact, three-law logic is violated but four-law logic is not violated. In four-law logic, an object can have infinite mass and zero mass simultaneously. The electron's frame and the photon's frame are rotated orthogonal to each other. What we were calling a photon in the laboratory frame, is a perfectly ordinary three-dimensional object in its own frame, which is orthogonal to the laboratory frame. The electron (lab-frame) thus appears as a photon in the rotated frame of what we previously called a "lab-frame photon." Either an electron or a photon is both three-dimensional and two-dimensional simultaneously — in fact, the concept of separate, exclusive dimensionality only applies after one or the other dimensional aspect has been exclusively separated (observed).

Mass is determined by the resistance an object poses to an accelerating or disturbing force. Mass is also tied to three-dimensional objects; i.e., it is an  $L^3$  concept dimensionally. A photon, moving at the speed of light, can neither be speeded up nor slowed down; hence in one sense it exhibits infinite mass. On the other hand, the photon (which is a three-dimensional object in its own frame) has lost a dimension in its intersection in the laboratory frame, due to orthogonality. Therefore the photon appears as a two-dimensional  $L^2$  entity in the laboratory three-space. And in that sense, the photon must have zero mass since it is only two-dimensional. By

the fourth law, the boundary opposites are identified. Thus at the orthogonal boundary of three-space, zero mass and infinite mass become identical. And the photon exhibits both zero mass and infinite mass simultaneously because it is an entity that is on the boundary of the  $L^3$  "mass exhibiting" world. The photon has always happily behaved in a four-law manner, even though physicists could not comprehend its behavior with the three-law logic ingrained in their heads.

## 6. Synchronicity of Concepts

As is so often the case, two persons appear to have derived the new logic simultaneously, myself from perception theory and Hubbard from manifold theory.

Dr. J. Hubbard was one of the scientists who first developed the atomic bomb. His profound work fully substantiates the new logic and the new reality paradigm. Dr. Hubbard believes that the system includes language, logic, and the interaction of life-bearing systems. In short, he believes it includes psychotronics. The relationship between mind and matter is, like Santilli's electric and gravitational fields, not mutually exclusive; they are either partially or totally one and the same thing. According to my research, they are both partially and totally the same thing, i.e., they are of exactly the same nature totally — a closure of the entire physical universe — but only partially intersecting, by a fraction of approximately  $10^{-42}$ . In the same fashion a mind is an entire physical world, but it only minutely intersects this physical frame, and then only in a portion of this physical plane.

Dr. Hubbard has shown that the four laws of logic emerge in the form of set relationships, that the single dimension parameter generates the second, third, fourth, fifth and up to  $N$ th dimensions of the manifold, by repetitive operations on itself. This allows a firm basis for orthogonal intersections of one less than the dimensionality of the lowest-dimensioned intersector. It provides a firm basis for orthorotation and for my approach to psychotronics.

## PRIMITIVE PERCEPTION

Let us now discuss how we form our concept of objects and their relationship. All our basic perceptual concepts are essentially built on primitive observation of the macroscopic universe, which is the primary reason that so many final arguments of philosophers appeal to the "natural man," i.e., to how a primitive observer would react to the argument. The very idea of an object — a perceived object — is conditioned. Everything else we think of is then conceived as some sort of object or relation between objects. And that is why sets (of perceptual objects) and their relationships form the basis for axiomatic logic, mathematics, and physics. Set theory is simply the synthesized and abstracted game of elementary perception of the macroscopic world. Thus even the most abstruse mathematics forms a part of the game of perception and can be applied to perceived physical phenomena. This macroscopic, primitive perception is the basis of our concept of objectivity, and of our physical concepts of "observed" and "observable." But if we examine

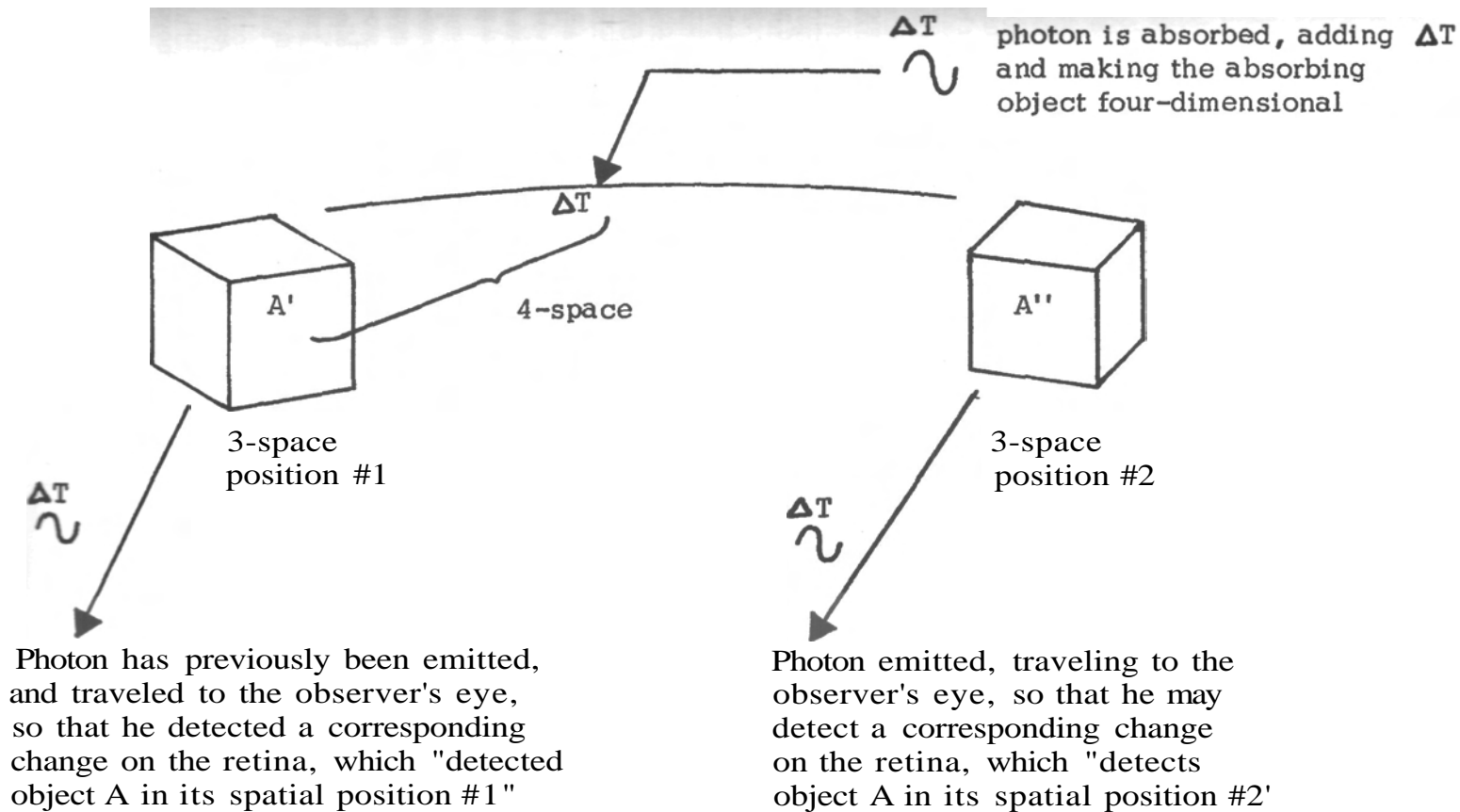

Fig. 6. Primitive perception

carefully exactly how we perceive an object in the macroscopic world, we realize that it is seen by means of photon interaction. We think of light being absorbed onto the surface of the object, and then emitted or reradiated from the surface, eventually entering the eye. There the photons are again absorbed by the material on the retina. The photoelectric effect then moves what are called electrons, producing a signal that goes to the brain for interpretation

What we see as an object has twice undergone interaction with photons of light. Furthermore, light itself cannot be detected, only its interaction with matter (in this case electrons). Thus the primitive perceptual operations of the human brain are correlated one-to-one with photon emission and absorption interactions, usually paired interactions at the object reality domain. The concepts of object, mass, three-dimensions, and observation are directly correlated to the photon-mass interaction, and ultimately to the photon-electron interaction occurring in the human retina.

The ideas of boundary, surface, and change in primitive perception thus involve two contradictory and simultaneously mixed interactions, absorption and emission. Because they are constantly intermingled, primitive perception cannot separate the two. Thus the primitive concept of a boundary consists of a simultaneous duality. Here the object both begins and ends. Here opposites are identified. This is the basis for the fourth law of logic, the law of the boundary.

The dimensionality and orthogonality (spatially) of the primitive perception process are also interesting. Photon absorption constitutes spatial integration for the photon, dimensionally speaking, *e.g.*, one additional dimension is gained by the two-dimensional light wave in turning itself into the three-dimensional mass state. The photon also adds its piece of time to the absorbing mass, converting the mass particle to mass time or space time—adding the fourth dimension. Photon emission constitutes spatial differentiation, dimensionally speaking. One spatial dimension is lost by a little hunk of three-dimensional mass turning itself into a two-dimensional wave. Going from outside the object toward the inside (to track along with photon absorption), the boundary marks the end of the two-dimensional wave region, so the object (or, more precisely, the interaction region) is spatially two-dimensional on the outside, and spatially three-dimensional on the inside. It also occupies the time dimension on the inside, but not on the outside. (This directly accounts for a difference in the spacetime inside and the spacetime outside, and that is why mass may be regarded as a curvature or change in spacetime, in general relativity.)

Going from inside the object toward the outside, the boundary marks the end of the spatially three-dimensional region and the beginning of the spatially two-dimensional region. So the object is now spatially three-dimensional on the inside, spatially two-dimensional on the outside. The inside now does not occupy the time dimension, while the photon emitted (the outside) does. So on the boundary, one spatial dimension is gained going in, and one spatial dimension is lost going out. Time is gained going in and lost going out, by the mass absorber-emitter.

Gain or loss of a dimension is accomplished only by orthogonal rotation between orthogonal spatial frames. Photon absorption constitutes orthogonal spatial rotation one right angle turn into the laboratory frame, while photon emission constitutes orthogonal spatial rotation one right angle turn out of the laboratory three-space frame.

This constitutes the observation process (primitively) per se, and this is what is hidden in Einstein's postulate that the speed of light is the same to every observer. Every observer goes through this same process. Furthermore, rotations orthogonal to a three-space frame are orthogonal to all three-dimensional spatial physical entities in that three-space. As Einstein himself once pointed out, velocity can be regarded as simply the measure of rotation of an entity in a higher dimensional space; thus an orthogonal turn is a fixed velocity. Since light is orthogonal to the entire space, then the speed of light is the same to every observer in that space.

While Einstein was apparently speaking of regarding the velocity of an object as a measure of its amount of rotation toward the time axis in four-space (from the direction of its velocity vector in laboratory three-space), it can also be regarded as rotation toward a fourth spatial axis in a five-space (four length dimensions and one time dimension, all orthogonal). If one checks this, one will see that the projections in three-space are the same; i.e., to the laboratory frame observer, there is no difference observable. Thus the photon interaction may be modeled as orthorotation of an entity spatially in a five-space.

To the laboratory observer, this orthorotation constitutes pure dimensional integration and dimensional differentiation, and it constitutes or creates an object in the first place. The concept of object *a priori* involves the photon interaction as stated; if the photon interaction is not invoked, then the existent entity does not exist as a three-dimensional object at all, in the primitive sense. Outside this primitive process (dimensional integration and differentiation imposed upon the same region, which constitutes an object), all exists in the Omega nothingness void, without frame or form.

Ultimate reality (specifically, action) is dimensionless in the objective sense; for the objective sense exists only after an operation has been imposed. A quantum itself is lengthless (and has no exclusive energy, time, or momentum) until differentiation is imposed upon it. Only after a quantum of action is fissioned does there exist a discrete piece of (change in) length, time, energy, mass, momentum, etc. I have already shown that perception itself can be modeled in terms of action quanta fission and fusion, and that most of the basic laws of physics can be derived from that model. (See my *Quiton/Perception Physics*.) Fission and fusion of action quanta involve orthogonal rotation between orthogonal three-spaces sharing the same fourth dimension (time) in common. The words *change*, *interact*, *localize*, *superpose*, *operate*, *move*, *oscillate*, *act*, *cause*, and *determine* are only a few of the words used in physics to conceal the basic occurrence of orthogonal rotation in higher dimensional space.

Finally, it should be stressed that  $i$ , the square root of minus one, itself constitutes an orthogonal axis, hence an extraspatial dimension. The addition of this quantity to electromagnetic theory allowed the resolution of formidable problems, and led to the direct formulation of electromagnetic theory. Thus electromagnetic theory already includes higher dimensionality and orthogonal rotation in hyperspace. In that sense, inductance and capacitance are merely vector statements of amounts of rotation, one in a positive direction and the other in a negative direction, toward an orthogonal axis in higher dimensional space.

The forming (beginning and ending) of a three-dimensional spatial object constitutes a time differentiation invoked on four-dimensional Minkowskian space,



i.e., the process of observation or detection itself involves

$$\partial/\partial T (L^3 T) = L^3$$

dimensionally speaking. This process is accomplished by orthogonal rotation, and the very concept of an object that has been observed, detected, or perceived implicitly involves this time differentiation invoked on a four-space.

Velocity also represents a statement of the switching of time into length, and length into time. It is therefore a measure of rotation of the spatial three-dimensional frame, as Einstein pointed out. By this switching (orthogonal rotating, orthogonal flipping) of the chopping of time or beginning and ending of a small piece of time, we create a little delta  $T$ , just as we do each delta  $L$  for an object.

But the photon interaction process is monocular. Each photon must attack matter individually, and live or die in the process. Each photon born from matter is also born independently. Thus the primitive observation process is monocular, since it is totally in one-to-one correspondence with photon interaction that is monocular. Thus the observed world is monocular, quantized, discretized. Because of the particular one-to-one correspondence between our primitive concepts and a single interaction, we can conceive the world in no other fashion, unless we change the very basic factor of one-to-one correlation. This in fact has already been done for physics by Everett, whose theory of the universal wave function incorporates multiple simultaneous observation, and hence direct insight beyond the limitations of the monocular correspondence to the photon interaction. My theory does the same thing in the fields of logic and mind.

## TWO-SLIT EXPERIMENT

This experiment is fundamental to all of modern physics. Feynman, Nobel prize winner in physics, has stated that no physicist understands this experiment, and that it cannot be explained by any classical means. The reason is that it cannot be monocularly comprehended, i.e., the first three laws of logic cannot explain it. The fourth law can and does.

In the experiment, electrons are emitted from a source and travel past a doubly-slit wall region on their way to a screen. The apparatus is shielded against light. If one believes that the emitted electron is a little three-dimensional particle, much like a tiny baseball, then it should go through one of the slits and not the other. It would then hit the screen at one of the two spots indicated as the expected distribution, with a little scatter from those that chip the edge of the slit a bit. Electrons which do not hit the holes but strike the wall are absorbed.

We do not get this expected pattern. Instead, the pattern is essentially the same as the one we would get if each electron were a wavefront passing through both slits at once. However, each electron still strikes the screen in only one point; the distribution of these points fits the actual distribution pattern shown.

This stunned the physicists. They did not believe it at first, so they set up a photon gun and hit every electron with a photon as it left the emitter source and started over toward the two-slit region. That is, they determined precisely when a little electron was on the way, and the fact that it was like a tiny baseball and in just one

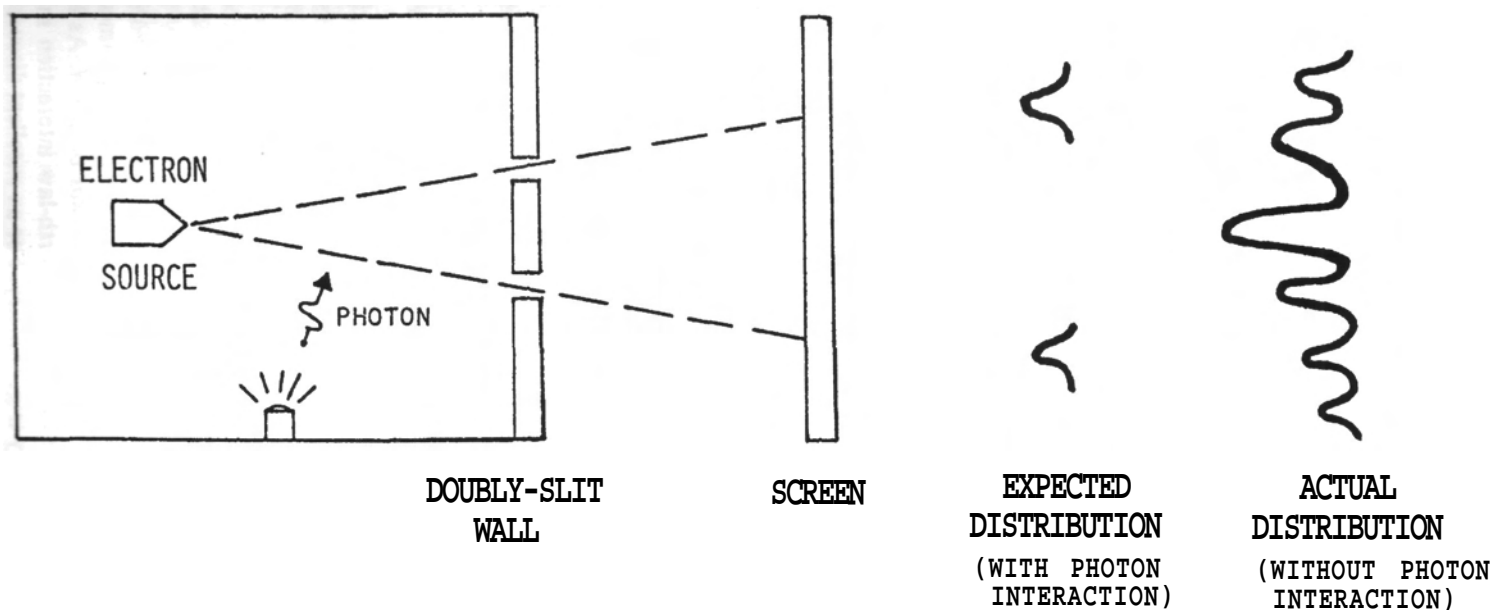

NOTE: IF THE ELECTRON IS HIT BY A PHOTON BEFORE IT REACHES THE TWO-SLIT REGION, IT DOES NOT EXHIBIT THE WAVE INTERFERENCE EFFECT, BUT INSTEAD ACTS AS A CLASSICAL OBJECT AND GOES THROUGH ONLY ONE SLIT, YIELDING THE "EXPECTED DISTRIBUTION" PATTERN.

Fig. 7. Two-slit experiment

place. And this time the electron only went through a single slit, and it gave the expected pattern after all. And when the experiment was repeated and only a fraction of the electrons were hit with photons, then a mixture of the two patterns emerged.

It is simple to describe the results mathematically, but no one has understood why things happen as they do in this experiment. The principle of complementarity evades the issue. This principle is simply a monocular statement dealing with one aspect of the problem at a time, with the determined, exclusive, monocular past only. It does not apply to the present or to the future. If we think in terms of the present, then the third law of logic is violated and the fourth law applies. The two states, two-dimensional wave and three-dimensional corpuscular, both exist simultaneously but nonexclusively in the present. Thus in physics terms, the entity becomes nonobjective (nonspatial), probabilistic and undetermined, and this is automatically a wave concept, i.e., since waves are not confined to one place and determined or localized, they may exist in the nonconfined, nonlocalized present.

Note that photon interaction must be excluded whenever the so-called quantum effect is exhibited. If photon interaction is invoked, classical reality emerges. Photon interaction creates classical objectivity. Photon interaction is a time-differentiating operator imposed on  $L^3T$  four-space. Specifically, since light carries time, photon emission from an entity strips away  $T$  from the  $L^3T$  nonobjective entity, converting it to an  $L^3$  or spatial object.

The very concept of an object comes from primitive perception's one-to-one correspondence with photon interaction. After photon interaction, the first three laws of logic apply to an entity. Before photon interaction occurs, the fourth law applies. In the fourth-law state, the time portion of an entity can interact with any number of time portions of other fourth-law entities if the time aspects of all of them coincide.

A free electron born and released at the emitter is four-dimensional ( $L^3T$ ) until it is struck by a photon, after which it is three-dimensional ( $L^3$ ). When the wavelength of electron and slits is specified, we have actually specified the time interval stripped out of a dEdT quantum in each quantum of fundamental change occurring. Perfect time synchronization accomplishes or constitutes orthogonal rotation. So if the length (width) dimension of each slit is very close to the wavelength of the electron, the time aspects of both slits will interact with the time aspect of the fourth-state electron if all three are brought into time phase simultaneously. If the slits are made much larger, this interaction will not occur.

When the electron interacts with both slits timewise, this will constitute a part of the past history of the electron to all future interactions or interaction possibilities. But since the interaction with the two-slits was not in the past (i.e., selected or determined), then that interaction itself is a part of the present and future probabilities chain. In physics, probabilities propagate forward in time with absolute causality until a monocular selection is made. Thus the fourth-law interaction is propagated forward with absolute causality and significantly affects any future interactions. And apparently vice-versa. John Wheeler has just shown that, in at least one sense, whether or not the emitted particle in the two-slit experiment has interacted with one or both slits can be selected *after it has occurred*. As is well known, the pattern of projection forward of this fourth-law interaction may be quite simply calculated from ordinary trigonometry. For an excellent discussion of

the two-slit experiment, see Richard P. Feynman, Robert B. Leighton, and Matthew Sands, *The Feynman Lectures on Physics*, Vol. 1 (Addison-Wesley, Menlo Park, Calif., 1963), pp. 37-1 and 37-12.

When the electron hits the screen, it encounters a region of varying time oscillations of the orbital electrons around the individual atoms comprising the screen. Thus the exact location of the orbital electron in the screen which will first precisely time-synchronize with the electron wavelength approaching the screen in four-law form will vary. Thus the place where the electron hits the screen is variably selected along the screen. The time distribution pattern of the approaching electron is recovered when the time distribution of the number of electron hits per screen length is plotted.

So one can build gadgets to cause four-law entities to multiply and interact simultaneously in time, even though the entities are normally thought of as being in different spatial locations when in the three-law state. And one can deliberately select the type of interaction to occur, four-law or three-law, simply by controlling photon interaction. The two-slit apparatus itself is a paranormal, psychotronic device.

This is the explanation of the two-slit experiment, which, according to Nobel prizewinner Richard Feynman, no one understands and which, according also to Dr. Feynman, contains the total mystery of quantum mechanics and the only mystery of quantum mechanics. The reason the two-slit experiment has not been understood is that the answer to the paradox was not present in the first three laws of logic. It requires the addition of the fourth law to explain the experiment.

And all fundamental particles — photons, neutrons, protons, electrons, etc. — exhibit the same behavior. So things, nothings if you will, can be processed in the multiplistic two-states-identified-as-one-so-no-single-exclusive state, as virtual and unobserved entities. In the multiplistic state they can be amplified, recorded, put onto tape, modulated onto RF signals, etc. And by our ordinary, objective, three-law science nothing is processed. And nothing indeed is what is there — a very special, structured, detailed, virtual set of nonexclusive, hidden-variable nonthings that is part of the new reality existing in the framework of the new four-law logic. In fact, this processable, structurable, nonobjective reality exists outside objective, three-law spacetime and is the basis for all psychotronic phenomena.

To our present monocular detection devices and monocular theory, such multiple-state entities are unobserved and hence are zeroes. They are pure vacuum, pure space, pure nothing, pure emptiness. But they are very real indeed, and they do physically exist, but multiocularly rather than monocularly.

The importance of the time interaction in explaining the two-slit experiment was noted as early as 1957 by Charles Muses in his introduction to Jerome Rothstein's *Communication, Organization, and Science* (Falcon's Wing Press, Indian Hills, Colorado, 1958). Muses pointed out that the celebrated wave-particle paradox remains a paradox only so long as the chronotopological phases of the phenomena are left unrealized in the analysis. The entire foreword by Muses is a remarkable document that analyzes the structure of time itself.

NOTE:

IN REFLECTED LIGHT,  
THE EFFECT CAN BE  
INVERSED.

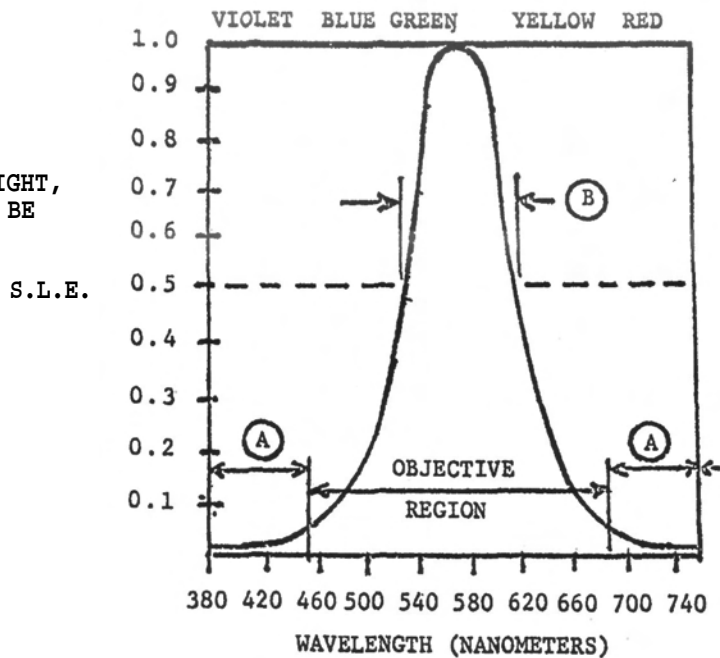

SUPPRESSION OF THE PARANORMAL  
CHANNEL BY THE PHOTON INTER-  
ACTION INCREASES IN THIS  
DIRECTION IN PROPORTION TO THE  
SPECTRAL LUMINOUS EFFICIENCY

- (A) WEAKLY OBJECTIVE REGION
- (B) STRONGLY OBJECTIVE REGION

Fig. 8. Photon quenching of the paranormal

# PHOTON QUENCHING OF THE PARANORMAL (TIME) CHANNEL

The photon interaction constitutes a time-differentiating operator imposed upon  $L^3T$  dimensionally (Minkowskian reality), which results in the creation of  $L^3$  dimensionality (objective, spatial reality). Aristotle's three laws of logical thought are based on primitive observation, which in turn is in one-to-one correspondence to the situation where the photon interaction has been imposed and the time dimension destroyed, resulting in a classical or objective or spatial reality. Hence all our present logic, science, and mathematics are based upon this particular arrangement. As shown by the two-slit experiment, if the photon interaction is not allowed to occur, a fundamental particle refuses to behave in a classical, objective, spatial object manner; instead, it behaves in a nonclassical, nonobjective, wave manner if the time element interacts with it.

Mental phenomena occupy the same time dimension as do physical phenomena; however, the spatial dimensions of mental objects do not ordinarily occupy or intersect the spatial dimensions of physical objects. However, the time dimension is recognized by physics as objective; therefore, since the mind occupies at least one real objective dimension, it is objective rather than subjective. This suggests a model whereby mind is a real  $L^3T$  Minkowskian four-space world, but one whose three spatial dimensions lie orthogonal to and outside the ordinary world's three spatial dimensions. The mindworld and the physical world then have in common the same time dimension. Dynamic movements in each world (mind and matter) result in an exceedingly small crosstalk being projected into the other world, a crosstalk so small as to be virtual and normally unmeasurable. Establishing one-to-one coherence between crosstalk from a mindworld constitutes the creation of a biological organism. The crosstalk from the mindworld and a physical structure in the ordinary world to the physical world has previously been labeled *inception* by me, and a mechanism whereby such a minute psychokinetic effect on matter can be amplified to a macroscopically observable level, or even beyond, has been derived. Thus a fundamental mechanism whereby tulpoid activity (projections from the collective unconscious materializing into the ordinary physical world, in a format determined by the collectively higher levels of unconsciousness in the race, national group, culture, subculture, and personal unconsciousnesses) is developed and explained.

Before the intervention of the photon interaction, four-dimensional reality thus has a great deal of tulpoid dither riding upon its time dimension as a minute modulation. The photon interaction invokes a time-differentiating operation, stripping away or suppressing the time dimension, resulting in a spatial reality or objective reality being perceived or observed, and in the process separating mind and body by destroying the only common connection or channel. Because of the time-squelching action of the photon interaction, we do not see time or the mind in our ordinary physical observation. Also, we do not see the incessant stream of tulpoid activity that bathes the time channel.

The time channel is thus the mental channel and the paranormal channel. The photon interaction is the destroyer or squelcher of the paranormal channel. Apparently the squelch effect of light is not linear or constant, but is a variable and a function of the frequency of the light being utilized. From a synthesis of a variety of

data in diverse fields, the following hypothesis has been arrived at to fit the experimental evidence: *The quenching of the hyperchannel (the paranormal channel or the time channel) by photon interaction is proportional to the spectral luminous efficiency of the eye of the average human observer in the interval from the infrared to the ultraviolet.* Thus the form of the paranormal squelching effect of the photon interaction is given by the operator  $\epsilon$  where

$$\epsilon = m E T$$

and where  $m$  is a parameter which varies as some function of frequency. This hypothesis specifies  $m$  over the region from the ultraviolet to the infrared. In other regions of the frequency spectrum, the form of  $m$  must be determined by experiment.

There are several experiments which fit the hypothesis:

1. The induction of death and disease patterns from test cells to environmentally shielded healthy cells by Soviet scientists.<sup>a</sup>

2. The invoking of specific tulpa living forms and photographing them in the invisible state with infrared film by Trevor James Constable.<sup>b</sup>

3. The visible light revival of appreciable fractions of cells killed with ultraviolet light and kept in the dark — dormant, unreproducing, for up to twenty-four hours.

4. Ingo Swann's precise differentiation of the visible light spectrum (frequency region) where psychic seeing (similar to remote viewing) is blacked out.

5. The Fox and Miller experiments, in which cell-like protein forms that reproduce (i.e. are "living") are generated when a primeval soup in the laboratory is bathed in ultraviolet light and exposed to strong electrical spark discharge (strong bioenergy collections).

A corollary to this hypothesis is that, under certain conditions, reflected light may reverse the effect. Thus the effect of the full moon, which reflects a great deal of sunlight, can immediately be appreciated. The effect is to the time channel, hence stimulation of this channel stimulates the mental effects. The effects of the full moon on romantics, lunacy, and deeper life functions controlled by the unconscious is grounded in a factual basis.

Thus there is a very good reason why animal eyes tend to operate very closely to the infrared, visible light, ultraviolet region, with the eye usually adapted for the visible light region. In the infrared and ultraviolet regions, tulpid phenomena would be readily visible or detectable, and an animal whose eye operated exclusively in one or the other of those areas would so often be distracted by the mental tulpid activity that it would prove disadvantageous to his survival against animal predators operating in the strongly squelched, visible light region. By the same token, animals whose eye operates further into the infrared or the ultraviolet than does the human eye are notoriously sensitive to paranormal phenomena before their manifestation to human observers.

The stimulating effect of reflected light, and particularly of light reflected from the surface of a planet or of the moon, also concerns several of the common practices of UFO investigators. It is common practice to dispose of a sighting once

<sup>a</sup>V.P. Kaznacheyev et al., "Distant intercellular interactions in a system of two tissue cultures," *Psychoenergetic Systems*, Vol. 1, No. 3, March 1976, pp. 141-42.

———, "Apparent information transfer between two groups of cells," *Psychoenergetic Systems*, Vol. 1, No. 1, December 1974, p. 37.

<sup>b</sup>Trevor James Constable, *The Cosmic Pulse of Life* (Merlin Press, Santa Ana, Calif.)

it becomes apparent that a planet lay in the direction of the sighting and was particularly bright at the time. However, such an optical condition can in fact serve as an initiation point for tulpoid activity to enter the ordinary reality frame. And in fact such conditions — and conditions when stars are very bright and twinkly in their reflections from the particles of the atmosphere — are conducive to UFO appearances, and this should be realized and taken into account. UFO's in a great many cases will be observed to start or come into being from such appearances.

If we realize that the paranormal channel is the time channel, then the fundamental two-slit experiment of physics is itself a paranormal manifestation experiment. Thus when the photon interaction is invoked, a classical object and classical behavior result. When the photon interaction is not invoked, a nonclassical entity and nonclassical behavior result. The more interest is taken in a particular tulpoidal manifestation, the more the format is impressed in multiple minds and multiple unconsciousness layers and the more frequently the format is tuned in. Eventually a repeatedly tuned tulpa can become stable and permanent. Candidates for such tulpoids presently on their way to being stabilized are the Loch Ness monster and the sasquatch. Particle physicists may in fact be creating their own reality by the same process, as suggested by Josephson.

The process whereby visible light revives cells killed by ultraviolet light is presently considered under the term "photoreversal." It is a moot point whether cells are living if they have laid dormant for several hours or even twenty-four hours without any cell divisions having occurred. The effect of a given dosage of ultraviolet radiation on cells is known to be greater when the radiation is flashed than when the radiation is continuous. This has been interpreted as due to a thermal reaction following a primary photochemical reaction, since increasing the temperature accentuates the effect of flashing. However, I suggest that flashing is directly related to the effect known as kindling, where, when the limbic structures of the brain are repetitively stimulated, the entire nervous system of the organism responds and goes into resonance (seizure). Soviet experiments have shown that such flashing of a telepathic sender enhances the reception of telepathic information. In the 1920's and 1930's A.G. Gurvich and his students found that a yeast detector's threshold of sensitivity to mercury lamp radiation was about three orders of magnitude higher than the detector's threshold of sensitivity to radiation of the same spectrum from biological material. (For a description of more modern work which may show a violation of the conservation of energy law, see L.L. Regelson, "A Paradox of Mitogenetic Radiation," edited by H.S. Dakin, translation available from H.S. Dakin, 3101 Washington Street, San Francisco, CA 94115.) Regelson's experimental results point to the conclusion that the paradox observed with the mitogenetic radiation experiments is a universal physical phenomenon. In view of this and Kaznacheyev's results, the entire area strongly warrants intensive investigation. Regelson's group was actually attempting to find a new solution to the problem of wave-particle duality, strikingly parallel to my interest in the area.

Those frequency points where the quenching effect is minimized (i.e., where  $\epsilon$  goes through a minimum value) are referred to as "magic windows" or "magic windows between worlds." Acker and Tiller have called them "interdimensional nodal points." In the magic windows, energy from one frame or biofield can be more easily collected to orthorotate into another frame or biofield, since the rotational threshold is much lower. There is a window, e.g., between 38,000-40,000



PHOTON INTERACTION CREATES OBJECTIVE AND NONOBJECTIVE

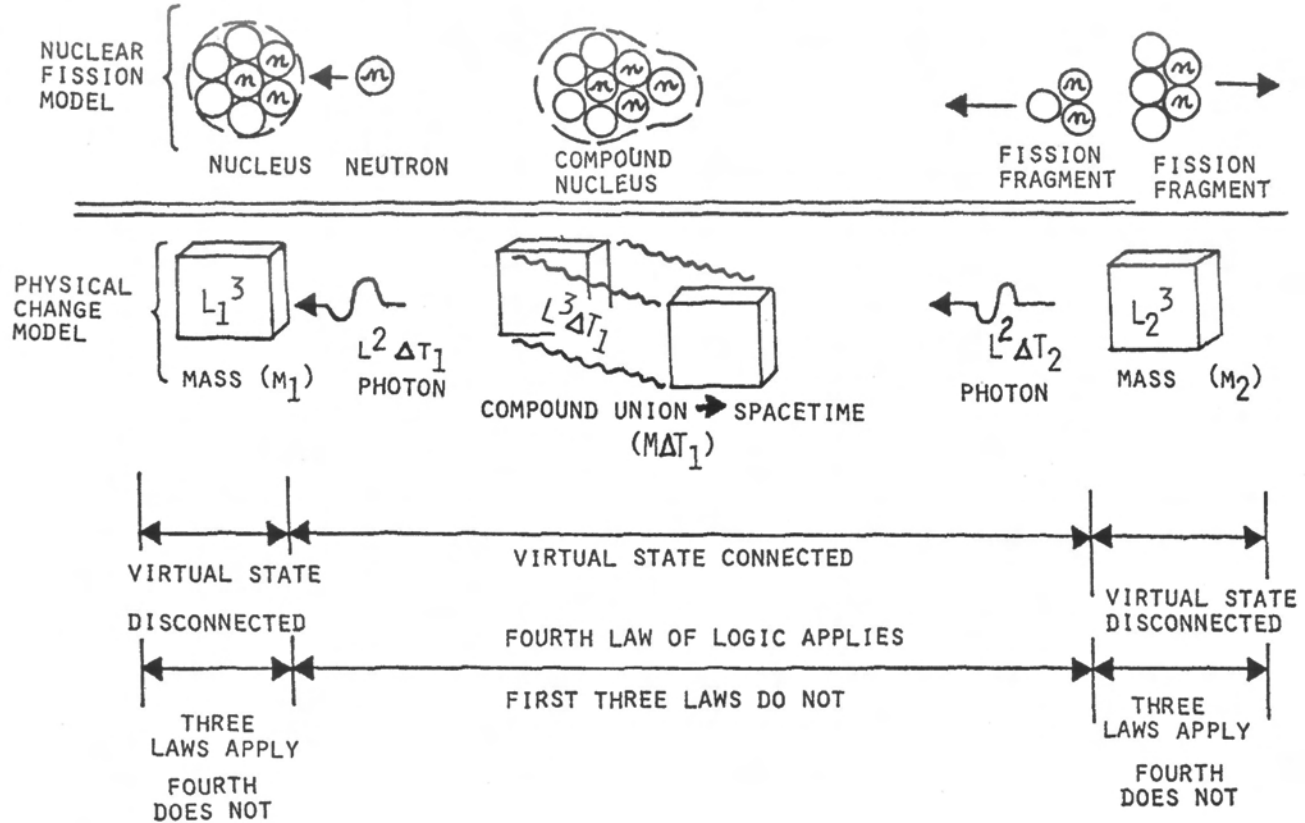

Fig. 9. Raindrop model of quantized change

Hertz, which can be stimulated with ultrasonics or electromagnetic radiation. The ultraviolet region contains a window, as does the infrared region. Many other windows apparently exist.

Trevor James Constable photographs paranormal phenomena through a filter that is open in the IR and UV regions, but opaque to visible light. Thus the filter blocks out the strong quenching effect of visible light and looks in two magic windows, IR and UV. Constable is thus able to photograph phenomena that are not normally detectable.

## RAINDROP MODEL OF QUANTIZED CHANGE

What does not appear to have been realized to date in physics is that the photon interaction is the agent that creates objectivity itself, as is clearly established by the two-slit experiment. The photon interaction separates spacetime into space and time exclusively. An object, being something which occupies space ( $L^3$ ), is thus timeless. Objects do not exist in time, because the union of an object with time constitutes spacetime, which cannot be perceived, detected, or observed.

Only changes in (derivatives of) spacetime can be perceived, detected, or observed, but not spacetime itself. That with which light has not interacted is not objective. This is proven conclusively by the two-slit experiment, upon which all of quantum mechanics rests. In that experiment, if an electron emitted from the cathode and on its way to the two-slit region does not interact with light, the electron behaves in a totally nonobjective manner, appearing to pass through both slits at the same time. (Actually it goes around both spatial slits in time, and since both of the slits occupy the same piece of time, the electron can interact timewise with both of them.)

On the other hand, if the electron is struck by a photon before it reaches the two-slit region, it becomes a "hard, solid little baseball" and quite objective. In that case it can interact with (go through) only one spatial hole because it cannot interact in time. According to Feynman, this simple experiment contains the total and only mystery of quantum mechanics. Furthermore, it cannot be explained in any classical manner. No physicist in the world understands it, although the pattern of repeated electron strikes on a collecting screen is quite easy to compute by simple trigonometry.

Let me now explain what happens to a mass when it is struck by a photon, absorbs the photon, and re-emits the photon. First, a mass is an  $L^3$  object; the concept of mass is not a function of time, but only a function of space. It is thus three-dimensional. The photon is also three-dimensional, but one of its dimensions is the time dimension. The photon, being built of action, is constituted of  $(dEdT)$  or  $(L^2dT)$  dimensionally.

When the photon strikes the mass and is absorbed, the (AE) portion is turned into mass by orthorotating one turn and becoming  $L^3$  dimensionally. The  $(dT)$  portion is thus united with the spatial mass to give a compound nucleus of spacetime comprised of  $MdT$ . This compound nucleus of spacetime is not perceivable. When a photon is re-emitted, it may or may not be of the same frequency and energy as the previously absorbed photon, depending on the absence or presence of any other perturbations. At any rate, a small bit of  $L^3$  spatial mass is orthorotated to give an  $L^2$  intersection with the laboratory frame, which turns the bit of mass

into a small piece of energy,  $dE$ . In the orthorotation, a small piece of time is bitten off and joined to the  $dE$  to give a  $dEdT = h$  quantum of action, which now constitutes a photon. Photon emission thus strips away the time dimension, leaving a spatial object.

Einstein pointed out that the velocity of an object may be visualized as rotation of the object in higher dimensional space. Visualized as spatial rotation rather than rotation toward the time axis, the velocity of light in vacuum  $c$  merely constitutes the rotation of a piece of mass by an angle of  $90^\circ$  to the line of motion, in the laboratory space in which we visualize the photon (the rotated piece of mass) as moving. Thus the photon emitted from the mass is moving at  $c$ , the velocity of light, because of its orthogonal rotation to the laboratory frame.

Note that the spacetime compound nucleus has now once again been separated into spatial and time components. Time is moving with the photon. And that is why time moves or flows at  $c$ , the speed of light in a vacuum. Time is carried only by the photon, and photon interaction with an object produces that object's march through time. If the emitted photon and the previously absorbed photons do not have identical  $dE$  and  $dT$  components, then  $M_2$  will be different from  $M_1$ , and the mass will have increased or decreased. Considering the photon to consist of momentum and length components, i.e.,  $(dpdL)$ , a similar diagram can be constructed. In that case, if the momentum and length components of the emitted and absorbed photons are identical, then  $M_1$  and  $M_2$  occupy the same position ( $M_1$  has not moved). If these components are different, then the mass  $M_2$  will occupy a slightly different position than mass  $M_1$ , and the mass will have moved.

This, by the way, is the simple solution to the age-old philosophical problem of change. We simply identify  $M_1$  and  $M_2$ , calling them the same object. We cannot detect, perceive, or observe the compound nucleus of spacetime in the middle. Thus we experience change as a thing becoming something else, but still being the same thing. This totally defeats the first three laws of logic. However, fortunately we can easily comprehend it since we have developed the fourth law of logic.

The raindrop model of quantized change is taken exactly analogous to the raindrop model of nuclear fission, as shown in Figure 9.

## KINDLING EFFECT

G.V. Goddard and his associates in 1969 reported a peculiar kindling effect generated by repeated, periodic, low-intensity stimulation of the limbic region of mammalian brains. A sustained periodic signal input to the brain and central nervous system eventually sets up a cumulative resonance which increases in magnitude until the entire organism is in sympathetic resonance.

A laboratory rat at first continues to explore its environment in a normal manner when it is subjected to kindling. But after repeated stimulation at the same intensity, the rat will begin to rear up and its forelimbs will convulse. Eventually these bursts of electrical activity induce similar patterns in nearby brain regions, and the threshold becomes progressively lowered. Stimulation progresses to the amygdala, to the amygdala on the other side of the brain, to the hippocampus, to the occipital cortex, and finally to the frontal cortex. Kindling can start only in the limbic structures.

While kindling was originally thought to be a model of epilepsy, John Gaito of York University has reported that a different mechanism is apparently involved since the amino acid, taurine, which suppresses epileptic seizures in laboratory animals, does not prevent phenomena caused by kindling. Also, kindling apparently causes permanent changes in the neural circuitry. Pulsed repetitions of telepathic senders have also been shown to increase the reception of telepathic messages. Thus the kindling effect apparently applies to the paranormal channel as well as to more orthodox transmission channels. (For further details, see "Kindling, once epilepsy model, may relate to kundalini," *Brain/Mind Bulletin*, Vol. 2, No. 7, February 21, 1977; pp. 1-2.)

The kindling mechanism is a far more general mechanism than epilepsy researchers have realized. Coherent time collection of bioenergy in one bioframe "kindles" toward the threshold of the next bioframe, which has a fixed threshold. When sufficient kindling occurs to reach the threshold, automatic orthogonal rotation of the kindled bioenergy occurs into the next frame. There it simply constitutes the kindling or superposition of the imperceivable subquantum state into the perceivable quantum state. This is the mechanism whereby one kind of field can be turned into another. E.g., thought energy (third biofield) can be kindled into second biofield (flux), which can be kindled into first biofield (electromagnetic energy), which can be kindled into zeroth biofield (matter).

## BIOENERGY COLLECTORS

Good collector mechanisms exist in great variety, in both living and inert systems. Many good collector mechanisms exist in the human body. One mechanism that collects bioenergy and orthorotates it into ordinary electrical field with appropriate induced currents is simply the electrical current in the human nervous system. This is particularly true of the current discharges from and between the nerve endings.

Another collector for bioenergy in a living system is the mitogenic radiation between the cells in tissue. Taken as a flux, this mitogenic radiation would seem to have both a photon nature and a nonphoton nature. The cells, in their membranes and fibrous internal structures, are continually collecting and kindling bioenergy into electron currents and photons. The electron currents represent collections from the virtual state into observable state, and may in one sense be regarded as the lifting of electrons out of the Dirac sea by direct kindling (coherent superposition of virtual state energy into observable state energy). These kindled currents are thus superpositions or modulations on the ordinary electrical activity of the cells, fibers, and membranes. The mitogenic photons are also produced by direct kindling of the virtual state into observable state, in this case, by kindling virtual state photons into observable state photons.

Spark discharges, such as are used in Kirlian photography, are extremely good collectors of bioenergy. In Kirlian photography the film records ordinary photon interactions; however, the spark discharge from the finger is collecting and kindling bioenergy into ordinary electrical energy (specifically, into electromagnetic field, which then affects the electrical flux pattern). Also, bioenergy is being collected and kindled into ordinary photons, thus changing the photon pattern being emitted.

Furthermore, those photons being emitted are internally affected by the bioenergy that has not yet kindled to observable state electromagnetic energy, but is still virtual. Each photon carries the virtual state along in the little piece of time contained in the photon, and partially collected bioenergy which has not yet breached the threshold of observable photons is being carried in each emitted photon. These patterns are transferred to the grain atoms by photon absorption when the piece of time of the photon is momentarily added to the mass of the absorbing atom, and in turn are continually spread through the emulsion material atoms by the virtual photon fluxes of the charges, in both the nucleus and the orbital electrons of the atoms.

So the life pattern of a photographed object is captured on ordinary film — and indeed that pattern can be resonated through hyperspace with the object that was photographed, regardless of where the object is in the universe.

Note that there are many mechanisms inside stars and planets for the collection of bioenergy. We live in a vital, pulsing, living, breathing, bioenergetic cosmos, and life is everywhere. Patterns of life are riding in the light from the distant stars, from our sun, in the neutrino flux from the cosmos, in the graviton flux from the cosmos, in cosmic rays, etc. And so it is small wonder that living cells that form, reproduce themselves, and die can be induced in the proper primordial soup of nutrients when that soup of matrix forms and chemicals is bathed in ultraviolet light (one of the magic windows which contains a greatly enhanced transmission factor for bioenergy, hyperspatial energy, life energy), and stimulated by electrical spark discharges.

It would be interesting to perform the same type of experiments with concentrated light from distant stars, or with the mitogenic radiation from cell cultures, using environmentally shielded setups similar to those used by the Soviets in experiments with the transmission of death patterns.

Even stranger, bioenergy propagates along deBroglie waves, and so all possibilities are modulated by bioenergetic kindling and collection. Viewed in this light, Puthoff and Targ's remote viewing experiments actually provided a multitude of probability paths to the viewer, and these probability paths were indeed kindling bioenergy of the distant, as yet unhappened event. The actual event in the future contains a great many additional collection kindlings due to the additional factors involved in determination (such as collapse of the wave function). A peaking of signal exists on the more probable happenings, and this extra signal along certain paths constitutes an increased signal-to-noise ratio in that particular channel. Thus an actual mechanism exists for seeing at a distance and for seeing ahead in time.

Particular note should be made of the pi meson collection mechanism in the nucleus of an atom. Each neutron and each proton in the nucleus of an atom is continually emitting and absorbing pi mesons, and thereby the protons and neutrons are continually interchanging from one to the other by passing along the positive charge. This activity produces the strong force which binds the nucleus together against the electrical repulsion of the electric forces due to the positive charges of the protons. The fantastic structurings and currents that result provide an electrical current which can and does collect bioenergy. A skilled psychic with good psychokinetic ability can thus focus on the kindling mechanism inside the nucleus and get a signal-to-noise increase of the kindling of his bioenergy in nuclei as op-

posed to elsewhere in the material in other collection mechanisms. Several types of reactions can then occur. The protons may have their electric charges extinguished due to the extinguishing of the virtual photons producing the electric field on their pions. In such case, the atom simply loses its integrity, and some neutrons and photons are emitted from the atomic site into the surrounding material. This type of interaction thus locally softens a metal and produces severe heating in localized areas, changes in fundamental grain structure, and changes in fundamental characteristics of the metal.

It is by this mechanism and similar related reactions that metal bending can be and is accomplished by persons such as Uri Geller. The collection of bioenergy by graviton emission, absorption, and flux leads to antigravity and other psychokinetic effects. These are exhibited in rare levitation phenomena and more frequent poltergeist phenomena.

The list of collectors could be materially increased, but these should suffice to show the importance of the effect of coherent time collection, kindling, and ortho-rotation of one type of field into another. The collection of deBroglie waves is moving much faster than light, and for very slowmoving objects the collected and projected bioenergy on their deBroglie waves is moving at essentially infinite velocity. This accounts for the fact that Hieronymus observed an instantaneous cutoff of his monitoring signals from the Apollo astronauts when their space vehicle went behind the edge of the moon.

Looking over the list of collectors and carriers, it is obvious why even the best Faraday shields cannot shield out bioenergy communication. The deBroglie wave carrier alone will simply take the bioenergy right through any known substance — or more precisely, it will take the bioenergy around the three-space in which the barrier substance exists, since deBroglie waves are actually superluminal particles in a three-space more than one orthogonal turn away from the observer's three-space. The implications for psychic healing and psychic surgery are obvious.

## **PSYCHOMETRIC EFFECT**

Every mass communicates with every other mass in the total universe, with hyperspatial/virtual crosstalk between all parts and all masses. This yields a mechanism for psychometry.

Inside the mass, we have a large number of collector mechanisms, of the types previously listed and explained. All objects in the universe are in communication with this object, particularly large or close objects. Those objects that come very near or touch the chosen object for a period of time are most influential.

Briefly, the internal dynamic collector mechanisms of the chosen object perform collection and kindling of the virtual state; thus each mechanism is slowly changed by the influence of other objects in the universe. This is very like the diffusion of heat. The chosen object also communicates part of the influx away, normally reaching an equilibrium with its surroundings when these surroundings are stable. As the surroundings change, appropriate changes are communicated into the internal collector mechanisms of the chosen object, and appropriately diffused away to other parts of the universe, until equilibrium is again reached.

Note that the influence of nearby or touching objects is greater than the influence of distant objects under normal spatial considerations. In hyperspatial considerations, however, this is not necessarily true at all, since this chosen object's pattern may be tuned in through hyperspace without any loss of energy due to ordinary three-space separation distance. In the absence of such hyperspatial tuning, distance is a factor, and close objects have a greater signal-to-noise ratio in the collection and kindling than do more distant objects.

Thus an individual or group of individuals in the vicinity exert mental, emotional, and bioenergetic influence on the kindling being accomplished in the chosen object. The stabilized dynamic patterns of the localized chosen object thus are conditioned and kindled to contain patterns of the actions, feelings, and thoughts of the individuals around it, as well as the natural events that occur. It is thus a very exact record of its surrounding events.

A psychically sensitive person who touches the chosen object, or in some cases merely comes near it, enters into a communications exchange with it. His body-records diffuse into the local object, and those of the local object diffuse into his body. If the psychic is sensitive enough, he can gain impressions from the recorded events of the object. This is the scientific basis of psychometry.

A wide variety of data support this mechanism. Psychometry has been practiced since earliest times, and is still practiced today. A photograph is particularly indicative of the person photographed, since his entire record is imprinted psychometrically on the photograph.

Moreover, the entire record of the Earth is still in the earth, in all its detail. As indeed is the record of each star and its planets, riding on the light that reaches us from that star, and on the deBroglie waves from it. With operational biodetectors, we could easily read the records of the universe. NASA would do well to pursue this alternative in its attempt to contact extraterrestrial life, rather than point huge radiotelescopes toward the heavens and listen to the kindled static from the stars. The static indeed contains the message, but not in a format in which they are prepared to look! It is in the virtual state, riding in each photon.

To a psychic who can see the human aura easily, the condition and much of the record of the person is in that aura, because the auric pattern is changed by all experience of the body, mind, and personality. Thus a good healer can see the aura of the patient, tell if another healer has been in contact with the patient (including often recognizing which other healer it was), and can recognize his own previous contact with the patient many years earlier. (See, for example, the story of Agpaoa as recorded by Sigrun Seutemann in *Healers and the Healing Process*, ed. George W. Meek, Theosophical Publishing House, 1977, p. 93.)

## **ALL MASS IS CHARGED: EVERYTHING IS ELECTRICAL**

It is well known that all mass is charged; thus everything in one sense is electricity. To examine this concept, let us look again at the electron with its virtual photons being emitted and absorbed, which virtual activity creates the electric field of the electron. In classical theory the electron is visualized as if it were a little hard

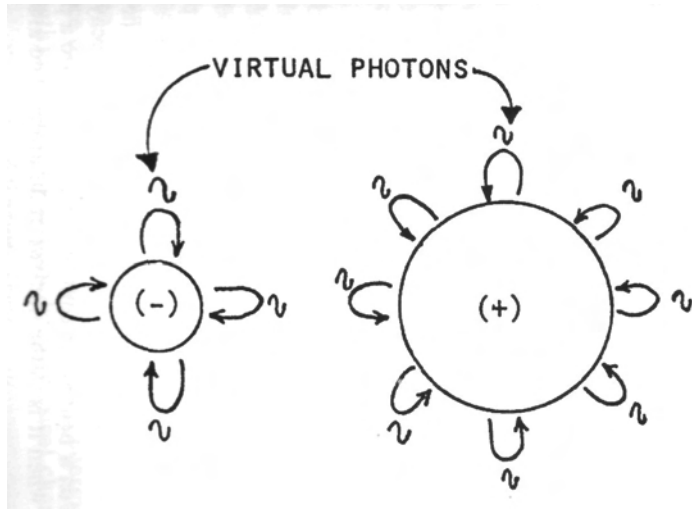

ELECTRON

PROTON

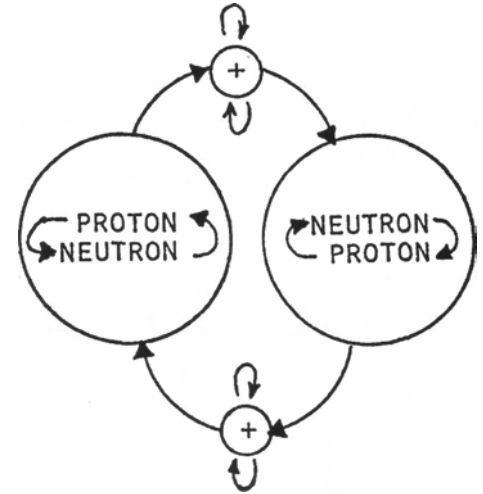

IN A NUCLEUS, EVEN A NEUTRON IS CONTINUALLY CHANGING INTO A PROTON, AND VICE VERSA, BY THE EXCHANGE OF THE POSITIVE CHARGE.

Fig. 10. All mass is charged: everything is electrical



spinning sphere; the spinning of its electric field then generates a magnetic component. This concept of spin is retained, even though the electron is no longer regarded simply as a little baseball.

From our viewpoint, the electric field constitutes a steady activity of the emission and absorption of virtual photons, and the electron spin is more of an implosion or explosion in higher dimensional space. That is, we visualize a fundamental stable particle as a precise closure of the entire physical universe, like the Einstein spherical model of the cosmos. Furthermore, we visualize multiple closure; first, a very gradual macroscopic closure gives the so-called gravitational closure of the Einstein spherical model, and a closure — in the case of an electron — of about  $10^{42}$  times as quick and small gives the charge closure. This second closure is considered to be at right angles to the first. In one direction the second closure gives a negative charge, and in the opposite direction the second closure gives a positive charge.

So in this view, spin is occurring in at least four spatial dimensions, not just three. It is more of an implosion or explosion into and out of this three-space universe frame. From such a model, we could expect that some startling physical phenomena might be possible. For example, we might visualize the implosive or explosive spin as similar to a vector flux. If these vectors are not precisely antiparallel when two like charged particles meet, then a resultant flux vector exists. Since spin is actually the quantity action (energy x time, or momentum x length, or mass x time), then the existence of a vector resultant means that enough action can exist to provide a quantum to be fissioned, which yields (creates) physical change. Thus such a resultant allows a collision or interaction to occur. On the other hand, if two like charged particles meet and their spins are precisely antiparallel, then no vector resultant flux exists. Hence no effective action exists to be fissioned and create physical change (collision or interaction). Thus two like charged particles with precisely antiparallel spin ought to run right through each other when they meet, with no interaction at all, electrical or otherwise, in complete contradiction to conventional collision theory and conventional electrical theory which states that like charges repel one another.

Such an experiment has been done, at Argonne National Laboratory, with colliding protons. When the colliding protons have antiparallel spins, they do indeed pass right through one another. And there dies forever the old idea of concrete, solid, material reality. The experiment is not predictable or permitted by present electromagnetic theory or conceptual models of the proton and proton interaction. The experiment is consistent with our dual closure holographic model of the universe, however, and is in fact predicted by it.

In a nucleus, we find both protons and neutrons (except for a single isotope of hydrogen, which contains only a single proton in its nucleus). However, these nucleons do not exactly maintain their exclusivity. Instead, a proton is continually changing into a neutron and vice versa; this metamorphosis is accomplished (in theory) by the continual exchange of a small particle of mass containing the positive charge. Thus a highly dynamic type of electrical current activity is going on in the nucleus. And in fact, this is the only way a neutron can be stabilized in ordinary matter; when freed from the nucleus, the neutron is unstable and decays in about eleven seconds or so. So even a neutron is continually changing into a positive particle, i.e., into electricity, when it is in the nucleus of an atom. And around

the nucleus, the electrons are in dynamic orbit, so highly dynamic electrical activity is going on in the outer part of an atom and also in the inner part. Thus indeed all mass is charged and everything macroscopic is electrical. And every physical change of a charged particle constitutes a modulation imposed upon its virtual photonic activity creating its electromagnetic field. These modulations are simply coherently collected to breach the threshold of the virtual (third) orthoframe, passing into the second orthoframe, then breaching the threshold of that frame, and passing into the first orthoframe, which is the frame of the electromagnetic field. The electric field is coupled by the dual closure mechanism to the gravitational field, and also to the mass. The entire mechanism constitutes the coupling of the virtual state reality to observable state reality, and the electromagnetic field plays a prominent part in this coupling. Psychotronics is nothing but the extrapolation of this mechanism and the formulation of a theory to allow the construction of practical devices based upon it. Put simply, psychotronics is *virtual state engineering*.

## A FUNNY THING ABOUT ELECTROMAGNETIC FIELD

According to the present theory of physics, the electric field is due to the continual emission and reabsorption of virtual photons. Let us examine that concept just a little further, because there are some interesting conclusions we can make if we are not afraid to take the final conceptual step to the bottom line implications.

First, each ordinary (observable) photon in the universe consists of a little piece (quantum) of nonobservable action. The units of action are energy times time, or  $ML^2/T$  {mass x length x length/time). The quantum of action in the photon is not separated into a separate piece of time and a separate piece of energy. And also, the quantum of action is a fixed, constant size or magnitude, given by Planck's constant  $h$  as

$$h = 6.626 \times 10^{-34} \text{ Joule-second}$$

All this says is that an ordinary photon has a certain size that is quite fixed, and it is made of the substance "action" which is totally nonperceivable and non-observable. Only changes in action are perceivable, observable, or detectable, never fundamental action itself. So physics already prescribes a universe made out of action, and that universe has no length, no time, no energy, no space, no concrete existence. Yet from it can be taken — by differentiation (which is simply separation) — any length, any time, any energy.

However, only a single quantum at a time changes or is separated. Quanta do not superpose. A single quantum can be split or fissioned into, say, a piece of energy and a piece of time. We can get as large or as small a piece of energy (i.e., change in energy) as we wish simply by adjusting the piece of time accordingly. The same type of separation is possible for momentum and length.

The fragments of the action quantum (say, a piece of energy and a piece of time) must then be stuck back together again (i.e., fused back into an action quantum) to get rid of them, and this particular part of the process has essentially been ignored by physicists. Anyhow, getting rid of the fragments (which gave us a piece of comparative physical change — energy versus time or momentum versus length) causes the just-completed physical change to vanish.

So at its most fundamental level, the entire universe is continually being created and then destroyed in sequence. The continual creation of a tiny piece of time and then the destruction of the piece of time makes us experience reality or change as if we were a pointer moving along a time line. We cannot see time because it is continually being destroyed by the change process, the very process of physical detection or observation itself.

Now if we invoke another kind of change, a virtual change, such that its size is always smaller than the actual quantum's size, then this kind of change cannot be detected, even theoretically. The concept of a virtual change is one such that the quantity of action that was changed was deliberately made smaller than the size required to throw the switch of detectable or observable change.

So if we have a virtual photon, it is simply a piece of action whose magnitude is always less than  $h$ . Here again, we can still get any amount of energy change we desire, merely by adjusting the size of the piece of time associated with that energy. This then means that the virtual photon is not big enough to breach the threshold of quantum change, and so cannot be observed or detected.

And here is the interesting bottom line ignored by most physicists and almost all the pragmatic scientists who run the orthodox establishments. The totally unobservable, undetectable virtual photons being emitted and absorbed are conceived as creating the electric field at the same time as observable physical change (ordinary quantum change) occurs. And the electric field, of course, can cause or induce change of sufficient magnitude to breach the quantum threshold and result in observable change. The bottom line is this: the virtual state can be collated and collected to sufficient magnitude to breach the quantum threshold and induce ordinary observable physical change. The electromagnetic field already does precisely this! And if reality can behave this way, as the physicists show, then let us simply accept that and apply it!

Note that we have now resolved the problem of negative time. The fusion process replaces the little positive piece of time that was formed in the fission process. A continual stream of such replacements constitutes a continual stream of subtractions of positive time. Hence this represents a negative time operational channel. Many of the equations of physics, e.g., Maxwell's equations of the electromagnetic field, should be reexamined with a view to this negative time operation. Dirac calculated such an entity, an electron traveling backwards in time, and noted that it would appear as a positively charged electron traveling forward in time. He thus predicted the positron which was later found in laboratory experiments. But of even more fundamental importance is that every piece of charged matter in the universe has such an opposite twin — the well known antimatter concept. So antimatter protons, neutrons, molecules, and physical structures exist. Indeed, this physical reality that we normally perceive has its antimatter twin which we are also unraveling backwards as we go. But here again the bottom line is far reaching: it means that we can coherently collect the virtual state to produce matter or its antimatter, which after all are nothing but macroscopic assemblages of quantum changes, and we can thus get free energy, materialization and dematerialization, teleportation, and antigravity by means of special modifications and developments of electromagnetic circuits. Each photon carries a small piece of time. And the entire virtual state reality is hanging onto that small piece of time as a modulation. That is where the probabilities are riding, in terms of the ordinary monocular

interpretation of quantum mechanics, all of these probabilities, and all possibilities, are concretely real and occupy orthogonal universes. Since they all share the same single time dimension, there is a time bridge or time channel connecting the universes. Each move or change in one of them crosstalks a tiny bit into each of the others. Since it is the photon which carries them, then each photon contains all possibilities and virtual states modulated upon itself. Photon interaction thus involves the communication of these possibilities and virtual states to the object with which the interaction occurs.

## EXTINGUISHING ELECTRICAL CURRENTS

With psychotronics, it is quite possible to extinguish electrical currents flowing in a circuit, or in the nervous system of a biological organism. First, an electromagnetic carrier (photon) is used to carry the psychotronic modulation pattern which will quench electrical currents. The particular psychotronic pattern is modulated upon each individual photon, in virtual state form riding upon the time component of the photon. This is totally different from the ordinary scheme of modulating an electromagnetic carrier; the normal scheme merely gates the rate of passage of photons (amplitude modulation), or changes the energy-time ratio on various photons as photons continually are emitted (frequency modulation).

In this case, virtual state patterns (probabilities) are added directly to each photon, in addition to whatever is done under the normal scheme of modulation. Thus the carrier can be electrically very complex or very simple. At any rate, the carrier with its psychotronic modulations reaches the target, and photons are absorbed continually and emitted continually by the target. The absorption of the photons and their modulations continually generate compound spacetime  $MdT$  nuclei and introduce the virtual state psychotronic modulations onto the mass's electric field, the modulations now riding on the virtual photons that generate that field. When a photon is re-emitted, the compound nucleus is split again, and the  $dT$  is carried away by the photon, leaving behind a changed virtual photon state on the non-temporal mass spatially left in between quantum changes.

As time passes, the virtual photons are more and more psychotronically modulated by the kindling effect. Eventually the collection breaches orthoframe thresholds and reaches the electromagnetic field frame, changing the electromagnetic field. If the psychotronic pattern is such as to create a positive charge when sufficiently kindled, the negative electrical charge of the kindled electron is simply absorbed or quenched from within, so to speak. And in this case no ordinary annihilation photons are emitted. Instead, the electron is converted to a neutrino when its electrical field is quenched, and it simply passes rapidly away through matter with no interaction and no damage or heating to that matter. Thus the currents flowing in an electrical circuit or in a biological nervous system can be quenched, without any other damage to the system, and without any pair annihilation radiation being produced.

The UFO phenomena very often demonstrate this effect, and the Soviet Union has long since weaponized it.

A simple way to visualize this process is to imagine the virtual photons of the electron as gradually being quenched. With the virtual photons gone, the electron has lost its charge and its electric field, and is now a neutrino. As a neutrino, it zips through matter with no interaction, and on out into deep space.

This mechanism explains why the electrical circuits of autos, radios, etc. usually are not damaged when they are disrupted by the UFO phenomena. Use of normal mechanisms to change or eliminate the electromagnetic field seriously disrupts the components of the circuits, heating materials, blowing fuses, and melting wires and components. The mechanism described here does none of those things.

The weapon aspects are of course formidable. Small transmitters with the right modulation pattern could be dropped, planted, or fired almost anywhere, and these could be set to disrupt equipment or human nervous systems. Their use in satellites is obvious. Small transmitters of a fixed time-life broadcast duration could be fired behind enemy lines in artillery shells. Tactical missiles could carry hordes of such small transmitters and drop them along the way deep into enemy territory. Essentially everything electrical is vulnerable if radiated long enough for sufficient kindling to occur. Powerful radar beams can be modulated psychotronically to give them effects at a distance, disabling vehicles, communications equipment, and men. Even searchlights can be so modulated. Pavlita's psychotronic generators are known to generate deathdealing effects, because he has demonstrated that they can kill insects, and he has admitted that men can be killed with generators that are large enough.

An even more radical approach is to transmit the desired pattern directly through hyperspace with a hyperspace transmitter, using either a set of triads for focusing at a desired spot in normal space, or using a witness to generate form resonance with the desired target object, much like one tuning fork kindles another of the same tuning into vibration. The witness may be anything that contains the pattern of the target, e.g., a photo or a model. In the case of a living organism, each cell contains the blueprint for the entire organism, so a group of cells from the organism can be used. This applies to plants as well as to animals.

## **DEATH TRANSMISSION VIA THE PARANORMAL CHANNEL**

As an example of the kindling effect and the variability of photon quenching of the paranormal channel, some extremely interesting experiments were performed by V.P. Kaznachejev et al regarding the paranormal transmission of death. Briefly, two groups of cells were selected from the same cell culture and one sample placed on each side of a window joining two environmentally shielded rooms. The cell cultures were in quartz containers. One cell culture was used as the initiation sample and was subjected to a deadly mechanism — virus, germ, chemical poison, irradiation, ultraviolet rays, etc. The second cell culture was observed, to ascertain any transmitted effects from the culture sample being killed.

When the window was made of ordinary glass, the second sample remained alive and healthy. When the window was made of quartz, the second sample

each cell as it dies emits a uv photon containing the exact virtual pattern of its death.

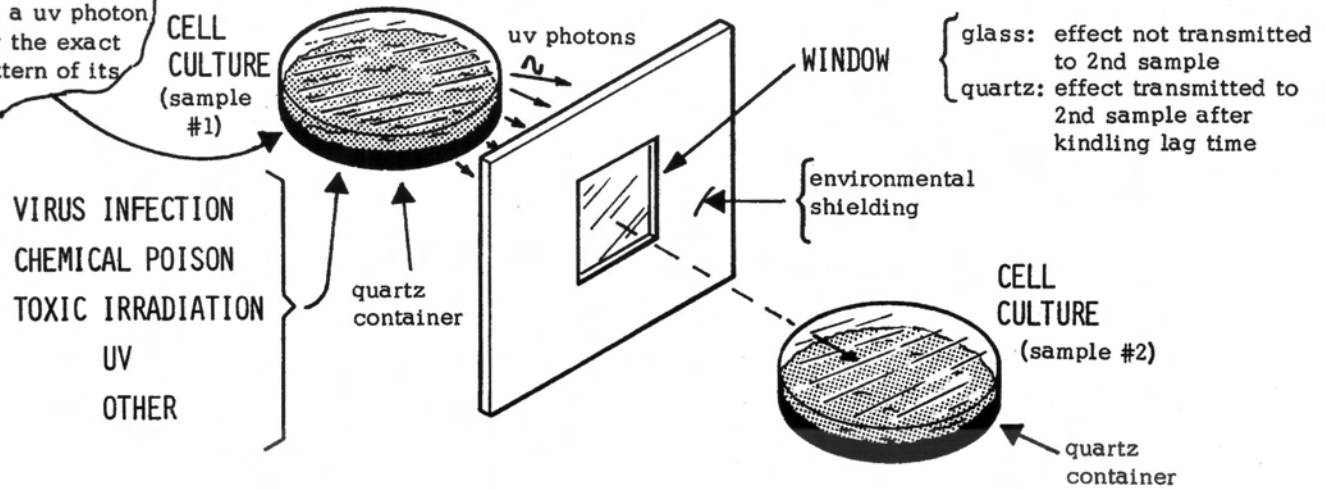

>5,000 EXPERIMENTS

INSTITUTE OF CLINICAL AND EXPERIMENTAL MEDICINE, NOVOSIBIRSK

INSTITUTE OF AUTOMATION AND ELECTROMETRY, NOVOSIBIRSK

**Fig. 11. Death transmission via the paranormal channel**

V.P. Kaznacheyev et al, "Distant Intercellular Interactions in a System of Two Tissue Cultures," *Psychoenergetic Systems*, Vol. 1, No. 3, March 1976, pp. 141-142.

sickened and died with the same symptoms as the primary sample. The experiments were done in darkness, and over 5,000 were reported by Kaznacheyev and his colleagues. The onset of induced complementary sickness and death in the second culture followed a reasonable time — say two to four hours — behind sickness and death in the primary culture.

The major transmission difference between window glass and quartz is that quartz transmits both ultraviolet and infrared well, while glass is relatively opaque to ultraviolet and infrared. Both quartz and glass transmit visible light. Thus glass is a suppressor of the paranormal channel, while quartz is not.

By performing the experiment in darkness through a quartz window, the four-law patterns of disease, sickness, or death engendered in the primary sample are not extensively squelched by the photon interaction, and these four-law patterns are transmitted through the quartz window into the second cell culture. Since the genetic patterns of the second culture are the same as those of the first, sympathetic four-state interaction and eventual kindling occur, resulting in the appearance of the effects in the second culture.

It is well known that cells also emit mitogenic radiation, including radiation in the ultraviolet and infrared regions. Since these same regions are not strongly suppressed by the photon interaction, one may hypothesize that paranormal effects may be strongly modulated onto infrared and ultraviolet photon activity, and there is indeed evidence for such an assumption. In 1950, Western researchers found that cells could be killed in darkness with ultraviolet radiation, kept shielded from visible light for twenty-four hours or longer, and then if radiated with visible light the cells would start reviving by hundreds of thousands even though they had been clinically dead.

Specifically, every cell emits mitogenetic radiation in the ultraviolet twice: when it is born and when it dies. The UV photon emitted at death contains the exact virtual state pattern of the condition of the cell at death. The healthy cells are bombarded with death messages from those that are dying, and this diffuses the death pattern throughout the healthy culture, eventually kindling into the same death pattern there.

However, the squelching of the paranormal channel by photon interaction is never complete, or paranormal phenomena could never occur in daylight. Hence paranormal patterns can be modulated even onto visible light, although only extremely weakly. Thus we may speak of the  $Q$  or sharpness of the paranormal modulation upon photon frequencies;  $Q$  is extremely low for visible light and may be extremely high for infrared and ultraviolet. In the visible light spectrum, it is probable that extremely large numbers of near-zero strength paranormal patterns are modulated on the light radiation; hence these patterns simply consist of a very weak background noise and the kindling effect does not apply. (The patterns are so random as to be self-cancelling in the kindling effect.)

## DISEASE AND DEATH INDUCTION

The base idea here is that an active agent must be involved to disrupt the ordinary healthy pattern of inceptive life functioning. Since life functioning is inceptive, ultimately the bioframes, specifically the first and second, must be distorted or disrupted. The first bioframe is the electromagnetic field and the second bioframe is a psychotronic field. The second bioframe may eventually be revealed as the *neutrino* field, but this is still uncertain at present. At any rate, it is a *virtual state* field. Virtual state patterns of a disease, for example, are carried in each photon emitted by a diseased cell. The life functioning psychotronic components are modulated on the body's electromagnetic components. Thus they have an electromagnetic carrier, which will carry the inceptive life function patterns through the photon squelching effects of emitted photons in the body.

A host agent such as a germ produces an active agent such as a toxin. The chemistry involves the particular compound of the toxin that is disruptive or deadly. But chemistry after all is rigorously based on electrical patterns. These electrical patterns of toxic chemistry contain psychotronic patterns modulated upon them by the germ, and these genetic life functioning patterns are different from those of a human cell. The foreign psychotronic patterns are modulated upon the human body's electromagnetic patterns (currents) and thus reach the cell, where they interact by the fourth law in the cell membrane, being demodulated and introduced to the cell, and orthorotated in the process into electromagnetic signals disruptive to the orderly functioning of the cell. The foreign psychotronic signals also jam the ordinary psychotronic patterns being demodulated by the cell in its inceptive operations from its mind frame or third bioframe. If this jamming is only moderate, the cell sickens; it is only disrupted. If the jamming is severe, the cell dies.

The normal electromagnetic noise bathing the cell from the cosmos and the environment contains random components that largely self-cancel or balance. The modulated random psychotronic modulations of the ordinary background environment behave similarly, and thus the normal background simply constitutes a weak noise flux which does not disrupt the inceptive life functioning. In the experiments of Kaznacheyev and his colleagues, photon squelching was largely restricted, and the psychotronic signals from the dying primary culture could go through the infrared and ultraviolet windows in the quartz as virtual state patterns on the mitogenic UV photons emitted by dying cells, and be introduced directly into the secondary culture. The kindling effect then induced the disease or death pattern after an appropriate time delay. Thus it appears that there is indeed a fundamental mechanism by means of which a disease or death pattern from one cell is introduced into others.

If this is true, then an exciting vista emerges for the treatment of hither-to incurable diseases such as cancer. The psychotronic pattern of the cancer cells in a person's body could simply be recorded, then phase shifted 180 degrees, remodulated upon an RF carrier, and radiated back into the body of the patient to cancel the cancer's signal patterns. Radiation of the body need not be severe at all; even weak radiation will suffice due to the kindling effect. At any rate, the hypothesized mechanism seems worthy of experimentation, and it seems to offer a validation of the practice of radionic treatment of disease.



## DYNAMIC THOUGHT CONSTRUCTS: BIOFIELD MECHANISMS

We will discover later that thoughts and thought objects are real, physical objects in their own worldframe domain. As such, thoughts, or thought objects, or thought constructs can be and are quite functional devices in the thought world domain. In that domain, they are as physical as a rock. We will also discover that thought energy can be turned into electromagnetic energy by kindling, and can even be materialized if kindling is of sufficient intensity. As an example, thought energy from negative thoughts continually repeated or held in the mind can cause one to become physically ill. This is a well-known effect, and such an illness is referred to as psychosomatic. However, the mechanism by means of which it is accomplished is not known.

Actually the mechanism is simple: in the minute electrical currents that run through the nervous system, across the cell membranes, through the fibrous content of the cells, and through the cell water structures, virtual state thought energy is continually kindled into weak electrical patterns, which modulate, shape, and affect all the vital processes of the body. Almost all this kindled thought energy is from the content of the unconscious mind. Thus the locked-in contents of our unconscious minds eventually directly affect and change our bodies for either good or bad, depending on the particular content being kindled.

Small wonder that we suddenly acquired a chemical problem some years ago after we were saturated by thousands of hours of pill advertisements on television, which directly implanted the idea that certain chemicals such as pain relievers contain the answer to life's problems, while others such as alcoholic beverages lead to a glamorous, active, exciting life. Not only can such material implant suggestions in the unconscious for association, but it can also directly condition the response that the body itself will exhibit to chemicals and drugs.

It is now fairly well accepted that there exists a cancer personality and a heart attack personality, where the mindset is definitely and causatively involved. And from the Simontons' work, we see that the mind can be effectively used in conjunction with other therapy to reverse cancer, even terminal cancer. But unfortunately, by and large Western medicine continues to rely on mechanics and chemicals. Essentially the patient is viewed as a mechanical apparatus and a chemical factory that is damaged, polluted, or out of sorts, and treatment consists largely of mechanical intervention (such as surgery) or chemical intervention (such as antibiotics). Medicine continues to be a science of the reparation of damage or malfunction. It is the science of disease, not the science of health. I do not advocate abandoning the medical practices that have proven effective. I do advocate the augmentation of such measures by all the mind measures available. In fact, medical science ought to be vigorously pushing forward into fields of psychic healing, psychotronics, radionics, etc.

# RADIONICS

In ancient development systems it was well known that the mind itself was a functional device, and that thoughts and thoughtforms could function as devices, influencing and affecting other minds and physical material. It was also understood that the thoughtforms had to be crystal clear and very stable. This demanded a great deal of practice in concentration. Eventually it was found that the stability of a physical form or device could materially assist the mind in maintaining stability. In ancient times many such devices were used: the dowsing rod, the crystal ball, the string-and-weight psychic pendulum, etc.

In the last century it was discovered that electrical devices could be used as tuning assistants. This led to the development of radionics, the name being inspired by the new electricity and magnetism discoveries, and particularly by the discovery of electromagnetic radiation. These radionics devices had a distinct advantage in the degree of precision they achieved in the tuning of the inceptive cyborg (operator's mind linked with the actual device through hyperspace). Ten resistors could be staged to give an otherwise almost unobtainable degree of accuracy and precision to the inceptive tuning. The use of variable resistors allowed rapid change of resistance, and thus rapid change of the overall cyborg tuning, and the ability to scan precisely in hyperspace, say, the emanations from a patient. In the hands of a skilled operator, such a device was often much more accurate than the finest medical test equipment available today, and infinitely cheaper and faster. In addition, such testing and diagnosis added little or no distress to the patient. This weird new radionics presented a formidable threat to the orthodox medical establishment. In the U.S. at least, the dogmatic medical establishment promptly came down hard on this potential threat to its hitherto unchallenged domination in the field of medical treatment. Its inquisition and purge was made easier by the fact that many charlatans also leaped into the lucrative field, having little or no actual diagnostic ability, and prescribing meaningless amulets and placebos for seriously ill patients. Also, the strangeness of radionics, such as the ability to diagnose illness from a drop of blood drawn from a patient thousands of miles away from the diagnostician and the radionics device, alienated many members of the medical profession who sincerely believed that no such diagnosis was possible, and that all such psychic demonstrations were frauds. Furthermore, the results, either diagnosis or treatment, were not usually repeatable by ordinary physicians and investigators since the psychic skill of the operator was directly involved. Organized medicine of course did not recognize the ability of the doctor to mentally or psychically intervene in the patient's illness, and so such practice was regarded as fraudulent and banned by the medical establishment.

The radionics practitioners were hounded into court, prosecuted, and convicted of fraud and of practicing medicine without a license. Several prominent radionics pioneers were actually hounded to death, Wilhelm Reich and Ruth Drown being the two most prominent examples. What could have been a great leap forward in medical science in the U.S., and the beginning of the development of psychotronics, was crushed by the power, ignorance, and bigotry of orthodoxy. To this day U.S. radionics has not recovered, and U.S. radionics practitioners are a rare breed, largely underground, who perform their experiments in suspicious secrecy and have only lately begun cautiously emerging from obscurity. In Eng-

land and elsewhere, radionics survived and flourished, and today one can legally receive radionics treatment in England.

## **PSYCHOTRONIC DEVICES: A SIMPLE SPACE (QUITON) AMPLIFIER**

It is possible to speak of the smallest piece of nothing, that we will call a "quiton." It does not monocularly appear as a perceived thing. Quitons are pieces of action, in which  $dEdT > h/4\pi$ . Quitons are virtual entities, and very small ones.

Collection of a sufficient number of quitons results in breaching a threshold, so that a thing results. To superpose quitons (dEdT's) must be of the same magnitude and time coherent.

Thus in any situation involving a particularized nothing, collecting enough pieces of that nothing eventually exhausts the nothing set and reaches its boundary, whereupon it is a thing. This is really not different from collecting all non-dimensional points in a particular sequence and finding we now have a one-dimensional line segment, or collecting all the pieces of spacetime warp in a particular region and discovering that we have now a mass.

A device can easily be constructed to process dual natured or binocular entities (quitons), which are monocularly zeroes, while excluding monocular entities. Thus we can build a space amplifier or quiton amplifier or vacuum amplifier. Two single-state excluders in a series feed or input to an ordinary single-state amplifier or processor in a shielded container. The output is fed into a device which will rotate the dual-state entity or field so that an ordinary field can result. One side or the other of the dual-state output will be exclusively present in three-space.

## **TYPICAL HIERONYMUS DETECTOR**

The Hieronymus device, patented by Thomas G. Hieronymus in 1949, is one such device. It has an optical front end, a prism which passes waves and does not admit particles. So a wave entering the front end will go through the prism and be refracted at an angle that depends on the frequency of the wave. Inside the surrounding box, which acts as a light shield, is a small tuner, a little copper rod attached to a rotatable wheel so that the rod may be moved through the various refractive angles from the prism. The prism is mounted on the box with a thin slit in the wall, so that only a small and narrow field of view exists external to the box. The tuner rod is wired to the input of a three-stage RF amplifier where each stage is separately shielded against light—which is very interesting, because of a similar requirement in the two-slit experimental apparatus if the electron was to act as a wave. The output of the RF amplifier comes out of the box and ends in a flat coil of wire between two parallel plastic plates.

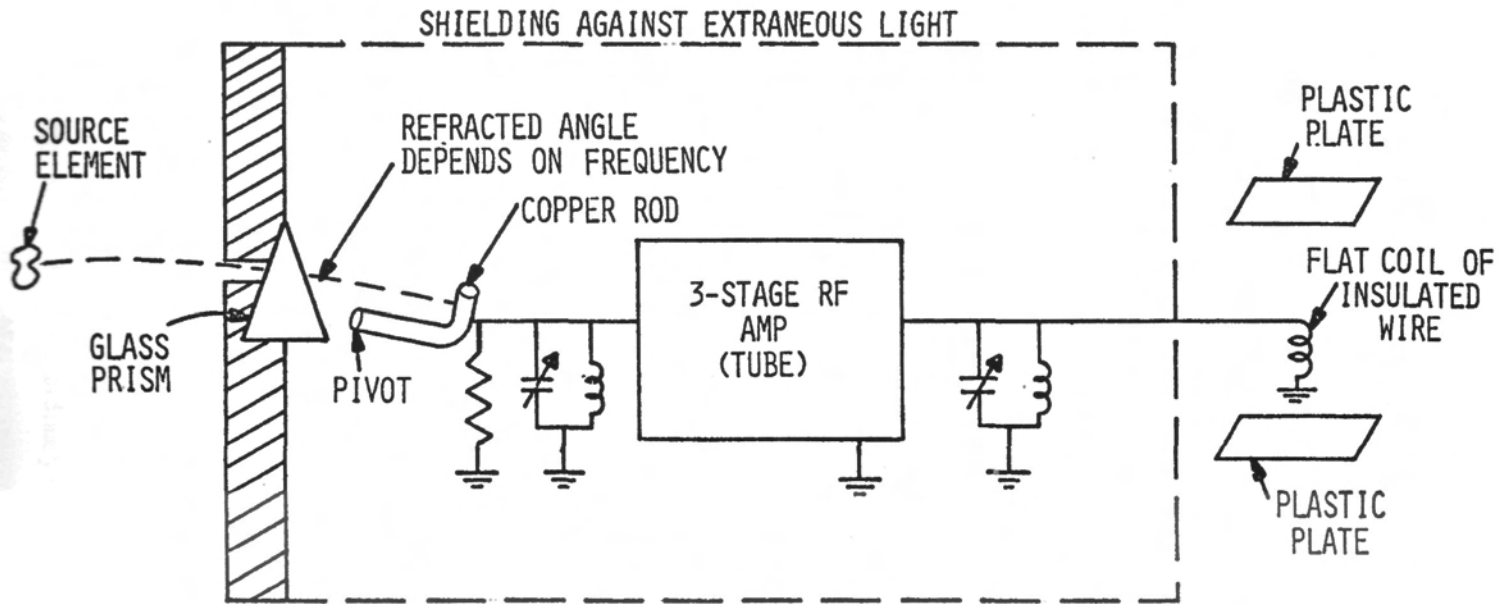

Fig. 12. Typical Hieronymus detector

Coming into the box through the slit in the prism, there can be single-state entities and dual-state entities or quitons. The physicist does not have a good name for a dual-state entity. They used to be called wavicles; today we talk about wave packets. But what after all is a wave packet? It is a three-dimensional bunch of two-dimensional waves! So that is where the physicists have hidden the idea of the dual-state wavicle today.

Only single-state waves and dual-state entities or quitons can pass through the prism and be refracted at an angle dependent upon the frequency. If we then tune the rod into the correct angle of refraction, the refracted quitons hit it, as do the single-state waves if their frequency should happen to coincide with the frequency of the quitons. Now the single-state wave dies when it hits the copper rod; it may chip a single electron or two off a copper crystalline grain, but that is lost in the thermal noise anyway, below the detection threshold of the RF amplifier. The quitons, however, simply say "Oh! Now you want us to act like a corpuscular electron, and go through those wires and conduction paths. That's all right, that is just our right hand side." So the quitons will go through and be amplified, just exactly like ordinary electrons would do. But now it is not electron energy, it is a dual-state analog of energy — let us call it anenergy, for analog of energy. (Hieronymus called it eloptic energy, since it could act as electron flow or as optical waves, but was neither exclusively.) The amplified anenergy will come out in the coil of wire and it will generate field and it is not a magnetic field, and so it cannot be measured on normal laboratory instruments. The simplest way to detect the anenergy fields is to use the human sensory system, because the human body knew about RF energy, frequency modulation, and anenergy long before we had modern electrical and magnetic instruments. (The use of anenergy is illustrated by acupuncture, a very ancient medical system dealing with the fact that a peculiar type of energy-like stuff flows in the body, and in certain points and structures of the body, it can interact with other energies and fields.)

Now if we believe we cannot sense the anenergy fields, then we cannot. We can turn the entire anenergy detection system in the body off with the unconscious mind. The negative psi effect is a well-documented effect in parapsychology. There are goats as well as sheep. Some persons do worse on psi tests than chance would possibly allow. They are the goats. They exhibit the negative psi effect, for unconsciously they want to show you that psi does not work, so they use psi effects to do worse than is possible by chance.

At any rate, the human sensory system can get a tingle from the anenergy field generated by the flat coil of wire in the Hieronymus machine's output. What type of tingle one gets depends upon one's own type of body sensory tuning. It may feel as if the fingers on the plastic plate are in thick syrup. Or as if the plastic plate were vibrating. Or it may feel greasy in a peculiar way. And the negative person does not get a tingle at all.

The Hieronymus machine has been built by many persons, and it works for those who are not negative. It processes entities that exist in the dual-state, or that obey the fourth law of logic. And we can do some almost magical things with these dual-state nonthings, these nothings, if we set our minds to it. This is what psychotronics is all about.

## ANOTHER KIND OF HIERONYMUS DEVICE AND THE INCEPTIVE CYBORG EFFECT

If thought constructs are actual operational mechanisms, then there should be other evidence besides psychosomatic illness and the demonstrated ability of the mind to cure certain illnesses. In fact, the Hieronymus device can be used to demonstrate this point.

John Campbell, former noted editor of Analog Magazine, once built an Hieronymus device and tested it successfully. Campbell immediately recognized that present physics could not explain the functioning of the device. In an exchange with Arthur Young, Young suggested to Campbell that it was the mind of the operator that made the device function, and that it was the symbolic form of the device that dynamically functioned to make it work. This appeared particularly significant to Campbell since he had discovered he could make the device work even though disconnected from its power supply.

So Campbell decided to test this thesis. He carefully drew on paper in black India ink a schematic diagram of the amplifier, removed the actual amplifier hardware, and substituted the schematic drawing. To his absolute amazement, the device worked as well for him this way as it had previously. But from our standpoint, such a result is not unexpected and can be readily explained.

First, I should point out quite strongly that Campbell not only was well-qualified technically, but even more important, he had an open and unbiased mind. This of course is quite necessary; the negative psi effect is well known, and the negative person is most certainly not going to allow his mind to operate the Hieronymus machine, just as he will not allow himself to succeed at dowsing, and so on.

Furthermore, in constructing the electrical schema of the amplifier, Campbell was strongly impressing stable thought constructs in his own unconscious, which was fully aware of the function of each part of the drawing. And when he connected that drawing to the rest of the hardware, he understood the function of the connection. He thus built in a thought connection from his thought-form amplifier to the hardware in a cyborg device. It then functioned as well for him as had the actual device. Campbell had proved that mind and matter may be cyborged into operational devices.

Psychic use of a pendulum, a ouija board, a dowsing rod, a crystal ball, and a crystal skull are other examples of the use of inceptive cyborg psychotronic devices, as is the use of radionics equipment of all types. And of course the most outstanding example of an inceptive cyborg where mind and matter are linked into one functional device is a living biological system.

Frances Farrelly, working with Arthur Young, took part in an experiment using an ancient Mexican figurine with a fluted neck. She succeeded in inducing fluted ears in a laboratory mouse. The mouse was exposed to the figurine about three feet away, and the cage or the mouse was connected to the figurine with a wire. Physical objects, such as mice bodies and fluted figurines, are three-dimensional channel tuners for orthorotating mind energies. Given firm initiation by a talented person such as Ms. Farrelly, a selected grouping of tuners can be resonated to collect bioenergy, and kindle it into ordinary energy and then into physical effects.

## PROBABILITY: THROW OF A DIE

The fourth law of logic is absolutely indispensable in physics. We use it every day and do not realize it in probability. But what after all is probability? Let us use a very simple example to get at the answer to that question. Let us use the face of a die turned up. How can I model that, before the die is thrown?

Now we can only think by operationalism. To operate and output something is to automatically put it in the past. It's happened, it's gone, the moment you do it. To perceive an object is to put it in the past. To determine it is to put it in the past. To observe it is to put it in the past. There is no observed, perceived, detected, measured, or determined present. That is, there is no separated, exclusive, determined present such as is specified by the first three laws of logic — the fourth law is the present, by the way — but in observational physics which deals with determined,

observed past phenomena, there exists no present. The future has not yet been observed, so it also is the unobserved. Only the past therefore is the observed. How then can one ever hope to model the unobserved present or the unobserved future?

If I look at the problem of the die with one face up, it is in the past. When I see it, it is in the past. When I think it, it is in the past. So if all I can observe, think, or perceive is the die in the past, how can I ever model it in the future? It's very simple! If I drive any problem set to its absolute boundary limit, it turns into its own opposite by the fourth law of logic, by the law of the boundary. So how do I do that with this problem of the die?

The problem set is specified by the condition "the perceived die with one face up"; this is the most recent past. Now simply find all the most immediate pasts you can get to meet the condition specified, and gather them all up together, and they then must turn into and comprise precisely the opposite, the immediate future. In this problem set, I can construct and collect six such pasts, each consisting of the perceived die with one face up. So by the fourth law of logic, those six faces up collected together as an ensemble represent the future and in fact are identical to the future. The present, which is simply the boundary between the most immediate past and the most immediate future, was specified by applying the fourth law of logic in the first place: the identity of the most immediate past and the most immediate future, being binocular, is unperceived, but it is the present nonetheless. So that is what probability is — an application of the fourth law of logic, so that the most immediate future can be represented in terms of the most immediate past — and physicists and mathematicians have been doing this ever since they have been doing physics and mathematics.

Without the fourth law of logic, there exists no rigorous logical basis for probability! So the fourth law is a very useful law indeed. We have simply failed to realize that we have been applying it all along.

The ontological problem can also be solved as follows: to state that "A is not" is to state that "A is" is not; to absent a presented thing is to first present it; to be "not-being" is a clear statement of the problem. By the first three laws of logic, the problem is not soluble. By the fourth law, it is simple since being and not-being can be identified. All distinction between present (being) and absent (not being) can be lost.

## **NEGATIVE TIME**

Negative time does exist and is used in advanced physical theories. Dirac predicted an electron traveling backward in time, which would be observed in positive time as a positive charge traveling forward in time.

The application of negative time to philosophy also allows the solution to the problem of good and evil. In positive time we may consider an act as evil — say the act of a hungry wolf seizing a hapless rabbit and devouring it. In positive time, we might say that to the rabbit the act was evil, and to the hungry wolf the act was good, noticing in the process that good and evil are relative terms, not absolutes. Examining the situation now in negative time, a very strange thing occurs. The remains of the consumed rabbit are regurgitated from the wolf's belly, again creating a living breathing rabbit, and reintroducing hunger into the wolf. Thus the act now is beneficial to the rabbit and detrimental to the wolf.

The point is that Allness or Godness is both sides of every coin, not one side only. Omega Godness exists both backward and forward in time; it must do so if it is to be unlimited, even by time itself.

Thus to such unlimited allness, every act is both good and evil simultaneously. Thus we can understand how a perfect creator could establish and ordain good and evil, for there is a sense in which the two are synonymous.

However, such insight is a very strong dose of medicine, too strong for the average stomach. Most persons never seek the Unlimited Godness; instead, they seek a good facet of Godness that itself moves forward only positively in time. Thus they find a partial image which is limited in and by the flow of time. By such an assumption the biblical phrase "I am Alpha and Omega" is unconsciously translated into "I was Alpha and I will be Omega." Thus orthodox Christianity long ago lost much of the God-insight originally given by the avatar Jesus. Only those few cloistered individuals who still struggle with exegesis grapple with the problem of good and evil. The problem indeed has a solution, but the solution involves negative time, the fourth law of logic, and an unlimited creator.

## **TIME OSCILLATION, QUANTUM CHANGE, AND MASS**

It is well known in physics that almost all physical theory is time-reversible, i.e., the equations hold true whether time is positive or negative.

This is important in the theory of antimatter. A positron (antielectron) may be regarded as an electron traveling backward in time. The destruction of an electron constitutes the creation of a positron, and vice versa, when we are observing in only one kind of time.

However, when we consider monocular quantum change, we realize that time can be modeled as a wave. To have any of the present physical quantities (energy, length, time, and momentum changes), a quantum of action must be isolated and fissioned into fragments. By this process we get a change in any physical quantity. This is fairly well understood in present physics, though not in this exact terminology.



However, what is not recognized in physics is that a disposal operation must be performed to clear away the fragments of one physical change before another can occur. The only way the fragments can be cleared away is to fuse them back into an action atom. Since action itself cannot be perceived (only a change in action can be perceived, not action itself) then fusing the fragments into a quantum removes the fragments.

This fusion operation removes positive time fragments (and other positive fragments) and so can be considered a negative time operation. Thus time can be considered to be an oscillatory wave because of its continual monocular discrete creation and annihilation by the quantum change process.

In fact, time oscillation may be considered to be the fundamental reality, and quantized change its result.

By the complementarity principle, time, being a wave, also must sometimes exhibit a corpuscular nature. (Indeed, all virtual state particles are nested within the structure of time.)

The Soviet work on time generating force thus is of absolutely fundamental importance. What has been released of K'ozyrev's work seems to be intentionally deceptive and of little value. His real work and that of his colleagues appears to have the highest Soviet classification, and none of this material has been released.

In the West, the only person of note who has grasped the fundamental import of time and time oscillations is Charles Muses. As early as 1958, Muses pointed out that there was no mystery in the two-slit experiment if the chronotopological features of the experiment were properly taken into account. Muses also worked out a hypernumber structure of time, but its significance seems to have escaped orthodox physics. Nonetheless, his work has direct technological implications, such as materialization and dematerialization of matter, and offers an approach to the engineering development of actual devices. Since his hypernumber theory of time structure also encompasses consciousness, it represents a union of physics and metaphysics on a common basis, and an approach to the engineering development of psychotronic devices.

Western physicists, then, would be well advised to pursue vigorously the idea of time oscillations, both theoretically and experimentally. And they would also be well advised to examine the hypernumber work of Charles Muses.

Since mind and virtual state occupy the time dimension, the nested structure of time contains the mechanisms for mental-physical interaction and for direct amplification of virtual state into observable state (or for the dissolution of observable state into virtual state).

## **MASS IS A TIME-DIFFERENTIATION**

The most fundamental aspect of the concept of mass is that it occupies space, i.e., that it is three-dimensional. Mass thus is a time differentiation of Minkowskian spacetime  $L^3T$ . Applying the fourth law of logic, a thing does that which it is and is that which it does. Thus mass is a time-differentiator.

Because of this, we cannot see time, the fourth dimension, although we can see  $L^3$  length, width, and height. Because we look through and detect with a mass

sensory system, the time dimension is lost in the act of looking and detecting, i.e.,

$$d/dT(L^3T) = L^3$$

and we thus see a spatial reality. Physical instruments also have mass and do precisely the same thing. For this reason, ultimately all measurement or detection is spatial rather than spatio-temporal, as is well known in physics.

Note that we do not see or detect total reality, but only a partial differentiation of it. Thus the position of the materialist's view is ironic: in his absolute insistence that reality consists in only what can be seen, touched, felt, or detected and measured with his instruments, he condemns himself to the greatest illusion of all, the notion that the outputs of his physical sensory system and his physical instruments constitute absolute reality. Also, since the only physical dimension shared by mind is time, mind reality is lost in the act of detecting, and hence only phenomena which are totally separated from mind are detected.

By the fourth law of logic, the existence in no mind at all constitutes the existence in each and every mind (nonexclusively). Thus physical phenomena are those phenomena that are processed by every mind. We will see that the fourth law enables us to deal precisely with mental, physical, and paranormal phenomena on that basis (how many minds the phenomena exist in).

## **REALITY IS LIKE AN OPOSSUM**

Reality is like a mother opossum carrying her little baby opossums on her tail, i.e., the entire mental-virtual state is carried along as virtual constructs, nested comfortably in the delta time portions of each photon. In the piece of time that is fissioned out of an action quantum to give observable change, there are a multitude of little pieces of time still attached to subquantum virtual state entities and hanging on, exactly like little baby opossums hanging on to their mother's tail with their own tails.

The world is so built, then, according to physics. And if we include our physical model of mindchanges, every possibility in fact concretely exists in that manner, in the virtual state, timewise hanging into the time dimension of the detected physical world's four-space frame, but spacewise hanging out of the ordinary three-space physical universe of objects. So indeed all possible realities, even the wildest and the most farfetched, exist in the virtual state.

The time channel is thus quite literally the paranormal channel that connects the normal spatial world to an infinity of nonnormal spatial worldframes. Only by the continual destruction of each piece of created time (by fusing it back together with the piece of energy involved, and forming a quantum which is unperceivable) are we able to experience physical reality at all, uncluttered and relatively free from the vast hordes of infinite realities through which the ship of quantum-change physical reality sails.

Since the electromagnetic field represents a collection of this vast array of realities, then by proper selection (i.e., by coherent tuning) of multiple stages we should be able to select a particular virtual reality channel. And indeed so we can. Any scheme for drastically increasing signal-to-noise ratios should be adaptable to such a collection mechanism for the detection of bioenergy.

In another sense, reality is like a television set with an infinite number of reality channels, but only one of which is tuned in at any one time. By adjusting the tuning, however, a different reality, including even different physical laws of nature, may be tuned in.

## BIOFIELD CONCEPTS

To understand the hyperframe approach to fields, we must understand the dimensionality of intersections in  $n$ -dimensional space. The dimensionality of an orthogonal intersection is one less than the dimensionality of the intersector having the lowest dimension. One intersector appears radically different to the other intersector since the second sees only a derivative of the first. It is the total projection of an intersector that is "seen" by that which it intersects.

Hubbard's manifold theory also derives these principles. The "types of reality" that these other objects appear to be will depend on the types of intersections they make with the frame of the observer.

This cannot be stressed too strongly: an observer sees his own frame, and intersections in that frame, nothing else. He does not necessarily see the entire reality of any object, and if an object is in a frame that does not intersect the observer's frame, the observer cannot detect that object at all.

Thus all types of reality are open to reinterpretation in the light of intersecting and nonintersecting frames. And to shift dimensions (increase or decrease), all we need do is add or subtract additional orthogonal intersections.

## MASS, FORCE, AND 3-D FRAME ROTATION

It is well known that a moving mass can be considered as existing in a three-dimensional space which is rotated away from the line of motion of the mass as seen in the laboratory frame. Einstein in fact pointed this out.

As the velocity of the object approaches  $c$ , the speed of light, the angle of rotation approaches  $90^\circ$ . From the bottom left figure it can be seen that a force in the laboratory frame, applied to the moving mass along its direction of motion in the laboratory frame, only affects the mass in the mass's rotated frame with a projected portion. To the laboratory observer, the mass's resistance to the disturbing force applied seems to have increased; thus to him the inertial mass of the object seems to have increased, i.e., if it is harder to push, its resistance to pushing must have increased.

But in the rotated frame, the object's mass has not increased. The rotated frame effect is *why* the mass of an object increases to one observer but not to the other.

When the rotated frame can be rotated to a full  $90^\circ$ , no force applied by the laboratory observer can accelerate it further, because the applied force has zero projection in the rotated frame where the mass actually is. Thus the mass (resistance to pushing) appears infinite to the laboratory observer, while to the rotated observer it is still exactly the same as it always was. Furthermore, to the rotated observer, **the** force being exerted on the rotated mass is zero.

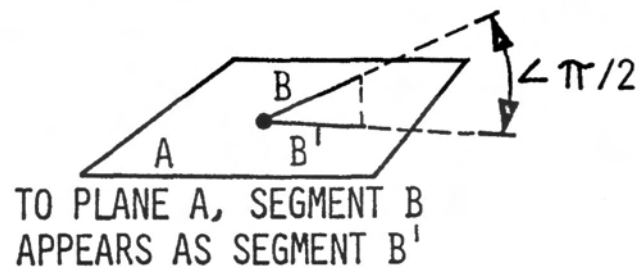
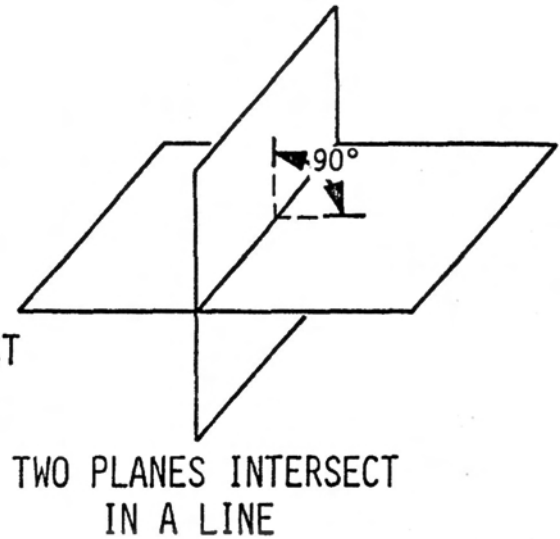
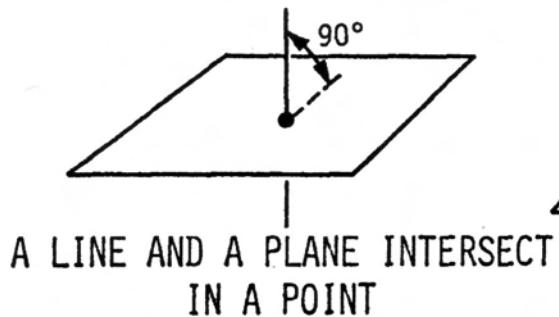
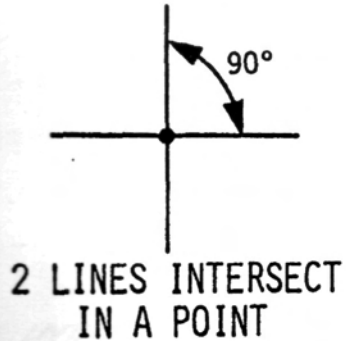
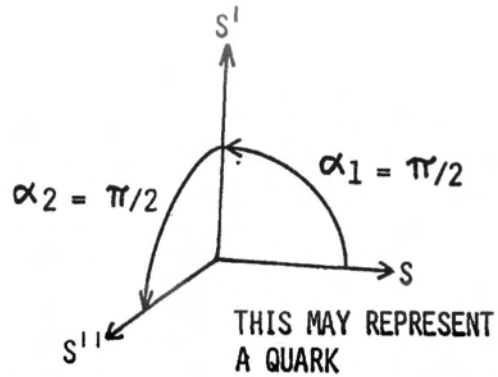
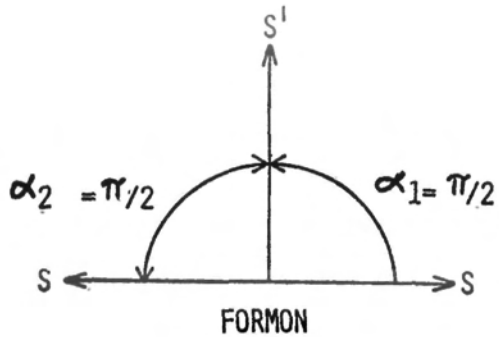

Fig. 13. Biofield concepts



$\pi$  BENDING OF A 3-D FRAME (TWO CASES).

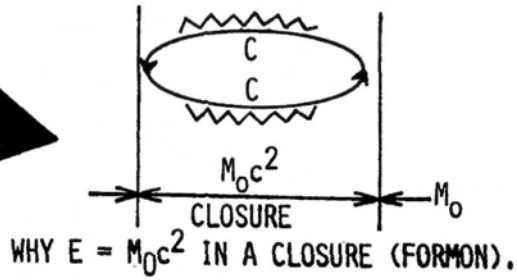
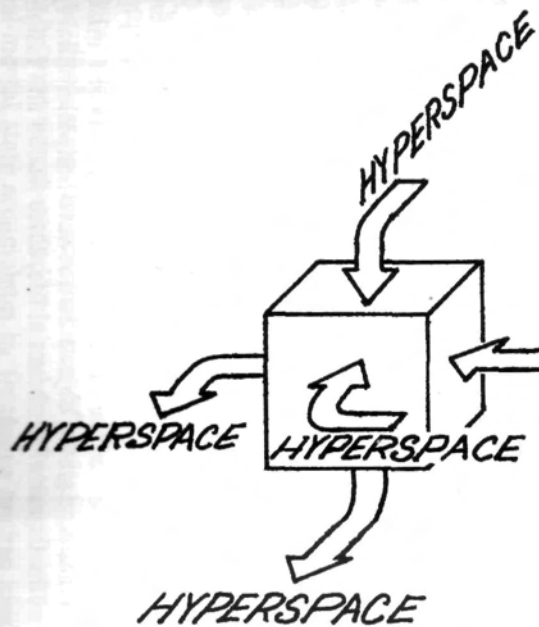
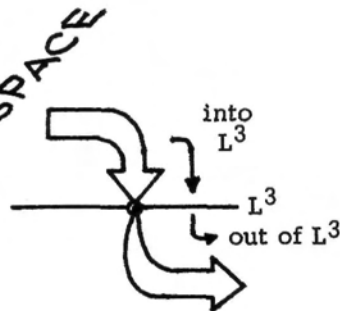

Fig. 14. Rotation of 3-D frames



MASS  
 A region of hyperspatial flux orthorotating in and out of  $L^3$  3-space.



MASS PARTICLE  
 The flux does not "move through" 3-space. It rotates in and out of each individual mass particle.

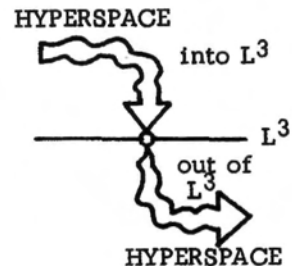

JITTER  
 Each flux line is not smooth, but jittered.

Fig. 15. Mass is  $\pi$ -rotation of hyperspatial flux

However, the mass's intersection in the lab frame is now two-dimensional. Since only three-dimensional objects can have mass, the object is massless to the laboratory observer. So here we have a paradox: zero mass is identical to infinite mass. This is perfectly in consonance with the fourth law of logic.

The absence of any single finite mass actually permits two indistinguishable solutions: the absence of any three-dimensional mass at all, and the exclusive presence of more than any finite mass. The two opposites are identical on the boundary case.

Thus a photon has zero mass because it is a two-dimensional object and only three-dimensional objects have mass. A photon also has infinite mass because it cannot be accelerated along its direction of travel. A photon is a perfectly ordinary three-dimensional particle existing in a normal three-space that is one orthogonal turn away from the laboratory three-space.

## MASS IS $\pi$ ROTATION OF HYPERSPATIAL FLUX

In Figure 15, I show that a localized mass is simply the result of orthorotational flux in and out of that localized region. This is a hyperspatial flux, since it actually is flowing or rotating in hyperspace.

This flux is related to the spin of a fundamental particle, and in one sense may be regarded as an extension of the concept of spin, i.e., ordinary spin is simply a derivative subset of hyperspatial spin (orthorotation between orthogonal three-space).

This flux does not move through laboratory three-space, but rotates into and out of it, at and for each fundamental particle of mass in laboratory three-space. As I point out elsewhere, mass itself is nothing but the absolute value summations of action quantum fission and fusion activity in a localized (fundamental particle) spatial region (*Quiton/Perceptron Physics*). Fission and fusion are orthorotations, or hyperflux activities.

Also, if we represent this hyperspatial flux by flux lines (a standard practice in physics), then each line is jittered because of its modulation by many higher-frequency components. This flux and the jitter in it play an important part in paranormal phenomena.

Furthermore, the hyperspace flux can be seen in two other ways: (1) as continual direct coherent collections of virtual subquanta to reach the quantum threshold, breaching it and becoming observable quantum change. Thus it should encompass essentially all hidden variable theories. This is the same mechanism by means of which virtual photons kindle and create electric field and the charge of an electrically charged particle; (2) as continual direct coherent collections of mind virtual state subquanta to reach the quantum threshold, breaching it and turning into observable quantum change (physical phenomena). Thus all matter is totally mind and totally alive — inert matter is just nonpreferentially alive. The resultant flux vector in an inert mass is zero since there exists as much flow out as in, and vice versa. This totally eliminates the classical dichotomy between mind and matter. It also implies that accelerated objects do not have nonpreferential type of life, but in fact have some degree of preferential life, since fission and fusion rates of an accelerated object are not equal.

Establishing sufficient pattern coherence in the parts of an accelerated system thus constitutes a preferential tuning between multiple parallel-directed directional coherences. This effect can result in establishing a one-to-one correspondence to and from one of the higher orthoworlds, i.e., it can result in a coherent circulation between that universe and the specific inert accelerated system. This circulation is easiest to establish through magic frequency windows where the channels of least resistance exist. This is the basic mechanism by means of which a living biological system is produced in and from the appropriate primeval amino acid soup in the presence of (a) magic-window induction (such as in the ultraviolet), (b) the acceleration of otherwise inert particles (such as is locally provided by lightning discharges), and (c) the strong collection of bioenergy to orthorotate it through three rotations (as is also provided by lightning discharges).

It is not accidental that life can be and has been created in the laboratory. This type of experiment, done by a team of strong psychics projecting intentional bioenergy forms, should be able to create specific forms of life. The same type of mechanism can occur inside the living body where it can induce psychomatic illness. A similar mechanism is probably responsible for the placebo effect, and possibly for the body's production of antibodies and the psychic modification of enzyme activity, psychic healing, etc.

## **JITTER OR DITHER MODULATES THE PRIMARY FLUX**

In the continual, virtual, subquantum, orthorotational flux (crosstalk), rotating into and out of a fundamental mass particle, only those components that are coherent are additive, and only those that add to the quantum threshold and breach it become observable quantum change.

In a given observable quantum change consisting of such coherently adhered subquanta, time is produced by fission of the quantum of action. All remaining statistical subquanta which have not collected to the threshold level are virtual subquanta of action possessing unfissioned, unseparated time. These virtual subquanta, which themselves are dynamic and gradually collecting and superposing to various degrees and at various rates, are attached to and exist in the dT interval produced by fission of the action quantum. Thus each and every piece of time contains dynamic, nested, virtual subquanta. Time in observable changes may thus be said to possess an internal dynamic structure filled with such virtual subquantum mental, neutrino, and photonic entities.

At any fission time, the degree of superposition of each of these nested entities is highly variable and depends on the whole past collection history, which in turn depends on all flux components of the proper frequency that have been arriving from all the orthoframes.

Thus virtual-mental entities cohere frequency wise until they breach the quantum threshold and discharge into observable quantum change. It is much like the accumulation of a static charge until sufficient potential is reached and a spark occurs, discharging the accumulation of charge. The same sort of relationship exists between virtual-mental state and observable state. The only difference is that virtual-mental state accumulates by frequency or time phase.



Since present physics is entirely localized, local observations cannot have taken into account distant matching-frequency events in the laboratory frame, or matching-frequency events in orthogonal frames. To the localized particle of mass, the precise moment a particular subquantum superposition of given frequency will superpose to the threshold and turn into quantum change is therefore not predictable. Since the remote causes cannot be accounted for, the local effects cannot be time-ordered.

Therefore at the quantum level, the physical change is totally statistical to a monocular observer. This accounts for the fact that the quantum world is statistical rather than causal.

However, a given fundamental mass particle has a structure of physical aspects, e.g., mass, spin, locality, frequency spectrum, switch rate, strangeness, etc. All of these may be expressible in terms of orthorotational concepts, although not all of them have yet been so worked out. Muses has already pointed out that some of the present quantum numbers are actually hypernumbers. And just as  $\sqrt{-1}$ , the first hypernumber, is an orthogonal rotation, so are the other hypernumbers.

At any rate, one may regard a fundamental particle as simply a complicated three-space tuning pattern existing in the orthorotational crosstalk flux between orthoframes. This pattern may also be said to consist of sets of frequencies, since each orthorotational flux line has a frequency of in-out-operation. Thus each fundamental particle is a set of tuning frequencies in the flux. A stable particle is a stable spectrum comprised of standing waves. An unstable particle is an unstable set, comprised of some standing waves, which account for the duration, and some not-quite-standing waves, which account for the excited state or degree of instability of the object.

On each flux line, orthorotational flux lines exist, constituting jitter or dither. Also, every fundamental particle is a tuning. It both tunes and is the result of its tuning, i.e., by the fourth law of logic it does what it is and it is what it does. Since tuning allows frequency communication between orthoworlds, then free-energy devices are not only possible but are practical. So are dematerialization-materialization devices, teleportation devices, devices that heal or kill, and anticancer devices.

## **THE UNTOLD STORY OF QUARKS**

We hear so much nonsense about the objectivity of science that it occasionally seems necessary to debunk the sacred cow. In fact, the quark story is a prime example.

In 1910, Millikan made his famous oil drop experiment and determined the charge-to-mass ( $e/m$ ) ratio of the electron. By multiplying this ratio by the mass of the electron, the amount of charge on the electron might be computed. Thus was born the idea of a constant amount or quantum of electricity, the fixed charge on an electron. Millikan received the Nobel prize for this famous experiment.

Actually, Millikan himself did not originate the experiment. One of his brilliant graduate students, Harvey Fletcher, first conceived the idea. Millikan became interested after he saw what a stir the results were creating, and he accepted the Nobel prize without sharing the credit with his brilliant student. Later Dr. Harvey Fletcher was to become the head of Bell Telephone Laboratories and an eminent managerial scientist in his own right. He also is the father of Dr. James Fletcher, former Chief Administrator of NASA.

Incidentally, Dr. Harvey Fletcher is still alive and alert, should anyone care to check the story! Nonetheless, it is highly doubtful that this grave injustice to Dr. Harvey Fletcher will be corrected.

But the story does not end there. In the late 1930's, a German physicist named Ehrenhaft decided to change the Millikan experiment and use charged solid particles rather than charged liquid oil drops. In fact he used red selenium spheres of various sizes. Amazingly, he discovered that he could isolate and measure fractional charges (quarks) at will, and he could even control the magnitude of the fractional charge isolated on a selenium sphere by varying the diameter of the sphere itself.

His work was duly published in scientific journals, and duly greeted with derision and hostility. Ehrenhaft himself disappeared during World War II. And there the matter lay. Dogmatic scientists continued to blindly teach the indivisibility of the electric charge, Millikan retained his exalted position and Ehrenhaft's work passed into comfortable obscurity. And in sophomore physics laboratories all across the nation, the indivisible quantum of electricity held full sway, dutifully proved over and over by the oil drop experiment.

Then in the 1960's, the particle physicists, despairing because of the bewildering new array of fundamental particles that continued to pour in confusion from their massive high energy machines, turned again to the idea of fractional charge (quarks) to try to make some unifying sense of the embarrassing abundance of strange new particles. By choosing three simple quarks, they could unify the theory of almost all the new particles. (Additional quarks have become necessary in the theory since then.)

So physicists gradually began to look for quarks, but in the giant, sophisticated, cumbersome experiments and devices that were yielding all the strange particles, not in the simpleton's approach that Ehrenhaft had taken. And they could not find them! Try as they would, a quark just refused to leave its tell-tale track. But in desperation they kept looking, and kept missing them.

Then in 1972 a convention of physicists was held at the International Center for Theoretical Physics in Trieste, Italy. Seven Nobel Prizewinners in physics attended the convention, whose theme was the physicist's conception of nature. Paul Dirac, the Nobel prizewinner who had theoretically predicted the positron before its discovery, gave the keynote address to the distinguished gathering.

Amazingly, Dirac presented the work of Ehrenhaft to the startled convention! He showed some of Ehrenhaft's data, and then pointed out that Millikan had also reported a single measurement of fractional charge, but had discarded it from consideration because he felt it was probably an experimental error. Dirac remarked that it all made him wonder whether Millikan might really have had a quark in that single discarded measurement.

The die was cast, and the seed finally planted. In 1977, about forty years after Ehrenhaft first obtained his quarks, someone finally got around to using solid paniculate matter. Researchers at Stanford University tried it out using niobium, and they got a little fractional charge on their niobium. So after forty years, Ehrenhaft, who had so long been ridiculed and ignored, was finally vindicated. It had taken the establishment that long to check his work instead of dogmatically rejecting it. Yet in none of the articles I have seen on the new discovery has there been a single word about Ehrenhaft, or of Dirac's presentation of his work at Trieste.

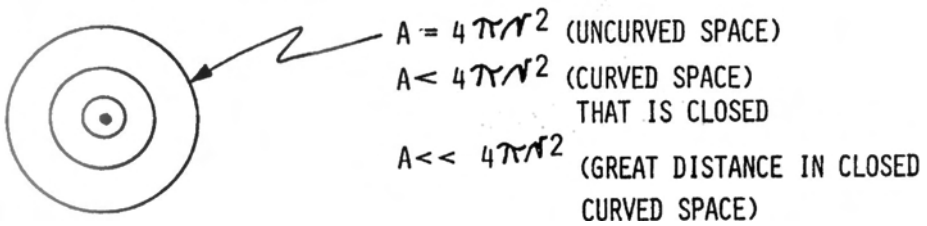

Fig. 16. Einstein's spherical model of the cosmos

## EINSTEIN'S SPHERICAL MODEL OF THE COSMOS

Einstein's spherical model of the cosmos is a primary example of a holographic universe. In such a closed spacetime, each point inside the universe is also at the extreme end of the universe in any direction. Thus the entire physical universe is totally outside any of its internal points, and totally inside each internal point as well.

That is an application of the fourth law of logic. The total internal is identical to the total external. The adjective "total" merely moves one to the common boundary between the operational concepts of "internal" and "external." At that boundary, there is no operational distinction between one and the other.

The universe closure is not limited to just one occurrence or one rate of closure. In fact the universe can then proceed to close again within the same local three-space, e.g., a gradual macroscopic closure due to gravity field (or causing it) constitutes the external universe, and a second extremely sharp microscopic closure due to electric field (or causing it!) constitutes electric charge. The two together constitute a fundamental charged particle of mass. The polarity of charge is determined merely by which of two directions the second closure was made in. Considering an electron as such a dually closed entity, it is readily seen that the closure ratios are all that is being referred to by Feynman's condition. Feynman pointed out that any unified field theory must explain why the ratio of the radii of the Einstein closed universe and the classical electron, and the ratio of the electrical and gravitational forces between two electrons, were the same — on the order of  $10^{42}$ . The model is also consistent with Santilli's proof that the electric field and the gravitational field are either the same thing or partially the same thing. In our model, an electric field is in fact a highly compressed gravitational field. Proper time synchronization should allow fantastic antigravity effects to be realized, and thus electrogravitics has a basis in this model.

## A CHARGED PARTICLE IS A DUAL CLOSURE OF THE UNIVERSE

It is proposed that each fundamental particle having electric charge represents a dual closure of the entire physical universe. The gravitational field closure is slow and weak, and it is that closure which results in the so-called external physical universe.

It is proposed that all particles participate in this same closure, since it is their combined distributed mass that represents or causes the closure. (By the fourth

law, "represents" and "causes" become simultaneous at the boundary, i.e., when closure is accomplished.)

There are two directions possible for this gravitational closure: one where gravitational masses appear to attract, and one where gravitational masses appear to repel. These two directions thus form antimatter closures with respect to each other. The G closure where G masses attract is said to be the closure associated with a positive time dimension, while the G closure where G masses repel is said to be the closure associated with a negative time dimension. The direction of closure represents or causes the time dimension's algebraic sign, and vice versa (fourth law).

The electric field (E) closure is strong and fast — on the order of  $10^{42}$  times as strong and fast as the G closure. However, its closure is in a direction orthogonal to the direction of the G closure. Since all matter is in motion, a slight deviation from exact orthogonality actually exists between the G and E closures due to crosstalk projection of components from the slight frame rotation involved in the velocity of each mass itself.

There are two primary orthogonal directions for the E closure. One direction yields positive charge and the other yields negative charge, for the positive time closure. For the negative time closure, the directions are reversed.

Such a schema, or version of it, can be made consistent with Santilli's proof, Feynman's criterion, and the observed fact that electricity can affect gravity and vice versa (electrogravitics). In fact, the electric field becomes a highly compressed gravitational field, at nearly  $90^\circ$  from the normal gravitational field. Liberating the compressed gravity in a flashlight battery could accomplish fantastic antigravity effects. Ironically, antigravity should be the simplest and cheapest effect ever dreamed of, once practical mechanisms for orthoshifting E field to G field are discovered.

Since psychotronics and quarks involve more fundamental components of electromagnetic field, hyperfields or biofields, psychotronic devices to yield anti-gravity should be quite feasible. The undisclosed extensions to Pavlita's psychotronic generators are thus of absolutely fundamental importance.

Furthermore, the ancients appear to have possessed psychotronic devices. Considering that metals, crystals, and other common materials can be used to construct psychotronic generators, and great power is attainable by the hyperchannel amplifier effect, it is quite possible that priests of several ancient civilizations actually possessed psychotronic devices to lift giant stones by antigravity, and other psychotronic devices to carve the stones like jelly. They may also have possessed psychotronic flying machines which used antigravity for lift and something like rocket propulsion for horizontal thrust. A flying machine that gets its lift from antigravity might be extremely crude in external appearance, and the use of hyperspace for travel would make it unnecessary to travel extensively through ordinary three-dimensional space. Thus many aspects of travel through normal space such as air drag and fineness ratio are of little importance to a psychotronic vehicle.

## **ADDING AND SUBTRACTING DIMENSIONS**

Figure 17 shows the relation between total collection (integration) and orthogonal rotation in hyperspace.

Total collection (integration) constitutes orthogonal rotation  
 in a direction to increase the number of dimensions by one

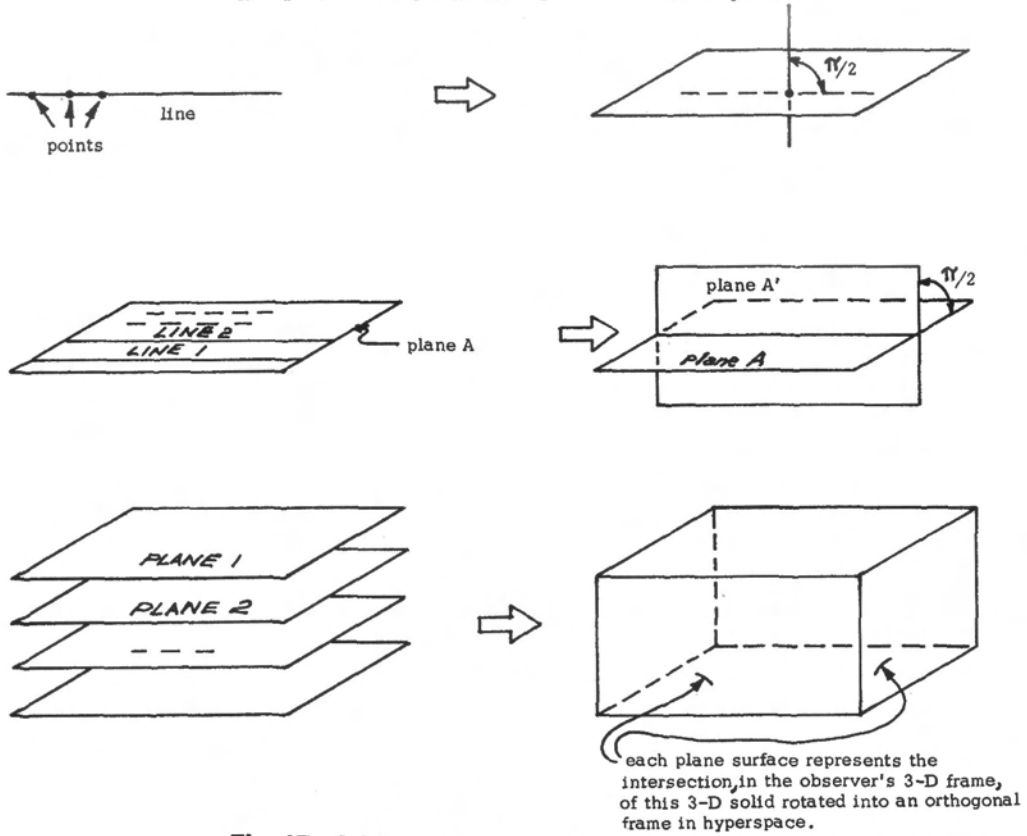

**Fig. 17. Adding and subtracting dimensions**

Total collection of zero-dimensional points in one direction integrates the points into a line (one-dimensional entity). This is precisely the same as if any of the points had been the plane intersection of an orthogonal line, and that line had now been rotated into the plane. Total collection in one direction is dimensional integration, and the collected entities gain an additional dimension, i.e., total collection constitutes orthogonal rotation of the higher dimensional object into observer three-space.

A point can be considered to be, and modeled as, a line in a frame one orthogonal turn away, and simultaneously as a plane two orthogonal turns away, and simultaneously as a solid (in fact, an entire three-dimensional physical world) three orthogonal rotations away. The latter may also be considered to be, and modeled as, a mind, or even as an infolded infinite set of minds. The concept does not stop at three dimensions, but proceeds into higher realms indefinitely. However, three dimensions plus an orthogonal time dimension are sufficient for our purposes.

A converse operation also exists. Differentiation consists of a cut in an object whereby one single element (of the collection the object represents), is separated and isolated, so that one dimension is lost. It is like a closure being opened at one element. This is the same as an orthogonal rotation of the entity (being differentiated) in a direction departing from observer three-space.

In the Figure, the lower two figures show the collection-is-integration schema for higher-dimensional figures. In the lower right figure, we cannot draw the three-dimensional object in its orthorotated position in four-space since we have only three spatial dimensions in the frame. Nonetheless, the additional dimensions exist and are simple to treat mathematically.

## MIND IS OBJECTIVE

In time differentiating, mass loses the time dimension. Therefore we cannot see time with a mass perceiver, but we can see  $L^3$  (spatial extension). But time is the only so-called objective dimension occupied or shared by mind. Therefore we also cannot normally perceive mind, because the plate (time) on which it was sitting is lost in the perception process.

Thus Descartes was both right and wrong. He was right in that monocular mind is not present in physical detection output, but wrong in believing mind and physical phenomena are totally separate. Time does not exist except with respect to between one  $L^3$  perception and another, if  $L^3$  is all that is outputted. Physical time is totally relative, totally mental, and exists only in memory. Mind is thus present in  $L^3 T$  four-dimensional physical phenomena and is discretized along with time discreteness in the Heisenberg uncertainty relation  $dEdt \geq h/2\pi$ .

In fact, we can even take the extreme view that time is mind. Because to establish a  $\Delta t$ , a former  $L^3$  must be established and compared to a more recent  $L^3$ . The only place the former  $L^3$  can rigorously be found is in memory. An event, once occurred, is in the past and is forever gone to the observer. Only in his memory can it be said to exist. But then so is the observation also of the most recent  $L^3$ . Thus, rigorously, observed phenomena may be said to exist only in memory, and there is only a past, never a present. Thus a full four-dimensional mind is inseparable from perceived physical phenomena, and mind is quantized along with quantum change in the physical world.

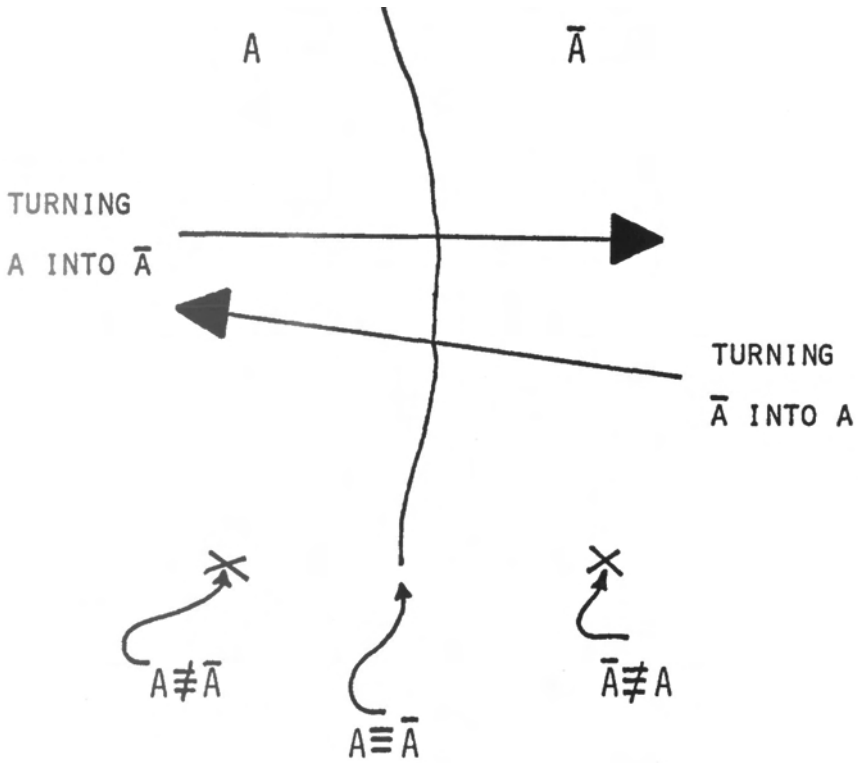

**A POWERFUL EXAMPLE:  
CANTOR'S PROOF THAT THE SET OF ALL SETS IS NOT A SET**

**Fig. 18. Turning a thing into its opposite**

## **THE SKIN TRANSDUCER EFFECT: TURNING A THING INTO ITS OPPOSITE**

On the boundary interface, one type of field may be turned into another. The higher psychotronic field (biofields) may be turned into an electromagnetic field, and vice versa. The boundary interface serves as a transfer function mechanism for translating one kind of effect into another. Both ends of the transfer function are excitonically united in and on the interface.

The Soviet work that measured coherence of cyclic rhythms (heartbeat, breath, body electric fields, etc.) in Kulagina is significant in this respect. Kulagina induced electrostatic fields around objects that she moved psychokinetically. Her biofield, which is connected through hyperspace to the object being moved, is orthorotated into ordinary fields at the interface of the object. Thus an electric field is created, and also a momentum field that causes the object to move by ordinary physics.

The Soviet work appears to have established that man, earth, and cosmos are psychotronically and coherently linked; that the boundary of an object is a transducer coupling internal and external dynamic changes in one-to-one correspondence; that the transducer effect applies to both living and nonliving systems; and that through tuning and resonance, internal patterns can be incepted externally, and external patterns can be incepted internally.

## **EVERETT'S MANY-WORLDS INTERPRETATION OF QUANTUM MECHANICS**

Both mind and matter can be precisely modeled in Everett's many-world interpretation of quantum mechanics.

Ordinary relativity is interpreted for only a single observer at a time. If you believe that you and I simply coexist at the same time, then the basis of physics is very different from what is in your physics book. Everett worked out what happens to physics if we insist on multiple observers at a time: all possibilities exist and are real, no matter how weird or far out; the world is a single giant universal wave function; collapse of the state vector has meaning only to a single observer; the world is composed of multiple orthogonal worlds of infinite variety, complexity, and strangeness; each world constantly splits into multiple worlds at a fantastic rate.

The many-worlds interpretation, though strange, is totally consistent with the experimental basis of physics. Most physicists have completely ignored Everett's profound and fundamental work; the MWI is a time bomb ticking away at the heart of physics.

## **SPACETIME CURVATURE IS TRICKY**

Bent and rotated spaces give strange results. A thing in one frame can be something quite different in another frame. Just as the mass of a moving object does not increase with respect to its own inertial frame, it increases with respect to the observer's static frame.

What a thing is, is totally relative to the perceiver and his perceiving frame. It can even be nothing in a great many frames. Do you see how nothing can contain everything?



So we really can turn nothing into something if we are clever.

We can solve the energy crisis by building free energy devices which simply cohere the nonintersecting virtual-mental energy states and collect them, breaching the quantum threshold and yielding real, observable energy. To put it another way, we can tap zero-point energy.

And we can also turn a thought-object into a real, materialized object in this physical frame. Or we can dematerialize a physical object, converting it to a mental object.

## MULTIPLE REALITIES (MANY WORLDS)

In Figure 16,1 show the particular selection of dimensions I take from Everett's many-worlds interpretation of quantum mechanics. Other and more complex selections can be taken, but these suffice for our purposes and allow us to complete the basic schema for connecting physics and metaphysics in the simplest possible manner. The selection and the schema developed thus provides an initial crude theory which makes predictions, develops theoretical mechanisms, and can be physically tested.

In the diagram, each three-dimensional physical frame of an infinite set at orthogonal angles to each other is shown by a single line about the plane of the bottom, much like the spokes of a wheel. The single time dimension shared by every one of the spokes or three-dimensional worlds is shown by a single vertical line, much like the axle for the wheel and its spokes.

Starting with the left spoke and going counterclockwise, the spoke worlds are numbered with the prime superscript system. The  $S$  world is the normal three-space physical world we all live in and detect; the  $S^1$  world is the first orthogonal world, etc. Each world is also called a hyperspace or bioframe or bioworld and numbered consecutively beginning with zero for the  $S$  frame. Thus the zero-th hyperspace is the ordinary physical universe.

The first hyperspace is the electromagnetic field. A physical object in this frame is seen as an electromagnetic field to the  $S$  frame observer. Since its intersection with the  $S$  frame is two-dimensional, we immediately see that the electromagnetic field is a plane wave. Light thus travels at speed  $c$  to every observer in the  $S$  frame, because  $c$  is or represents an orthogonal rotation.

Further than the first frame, a three-dimensional object is seen by the  $S$ -frame observer as a deBroglie wave. Since its rotation is greater than  $90^\circ$  with respect to the  $S$ -frame, the deBroglie wave always moves faster than the speed of light with respect to the  $S$ -frame observer.

A three-dimensional object in the  $S^2$  frame is seen by the  $S$ -frame observer as a line or force vector, i.e., simply as flux. (Tentatively, this frame appears to be the area of neutrinos.)

A three-dimensional object in the  $S^3$  frame is seen by the  $S$ -frame observer as a spatial point, i.e., as spatially dimensionless. It is thus a mental object or a virtual object to the  $S$  observer.

The entire  $S^3$  frame constitutes a mind or a virtual world. There are an infinite number of such  $S^3$  frames available in hyperspace. In fact, there exists a set of three orthogonal turns between any frame higher than  $S^3$  and the  $S$  frame, due to the nature of hyperspace. Thus in the model we are using, any of the higher bio-

frames may be considered to be only three orthogonal rotations away from the  $S$  frame.

We thus have a scheme of multiple worlds and multiple realities from which we may construct living systems, thoughts, tulpas, etc. And we may also turn one type of field into another, simply by virtual state collection or separation, as the case may be.

All frames  $S^3$  or higher are mental or virtual frames. Physical phenomena in these frames are mental phenomena with respect to the  $S$  frame.

Note that we have deliberately evoked a system whereby a mind is modeled in terms of physics and physical reality is modeled in terms of mind. The only difference between any two entities in the various worlds is a matter of orthogonal rotation.

For the pure mathematician, obviously this entire model could be extracted into a new calculus. A symbol could be assigned to the orthorotation operation, and a sign assigned to the symbol to indicate whether the direction of turning is approaching the observer or departing from the observer. Sideways turns and in-betweenwards-turns could be represented by additional signs, or hypernumbers. I suspect that such a calculus is well worth doing, and I also suspect that it will closely resemble Charles Muses's hypernumber work when done. Using a six-dimensional geometry, the German physicist Heim has accomplished something similar, without yet realizing that he has also modeled mind. His work generates all the fundamental particles of physics and explains many features of UFO phenomena, as is to be expected from the scheme developed here.

At any rate, an exact calculus of higher dimensions and of turning one kind of field into another kind of field — with no barrier at all between physics and metaphysics — awaits the hands of the builder.

## CLUSTERED ORTHOGONAL WORLDS

In this diagram, I show a sample of how various objects appear in their intersections with various bioframes. Note that an object is many things at once, and that many of the things it is are nonthings or nothings.

Everything is a thought in at least one frame. We can appreciate James Jeans's remark that the world appears less and less like a mechanism and more and more like a single thought. His intuition was in fact literally correct.

Each entity is a photon in at least one frame (let there be light!) Each entity is a line in at least one frame. Each entity is a three-dimensional spatial object in at least one frame.

By orthogonal rotation, a thing can change its face with respect to an observer, appearing to change into a totally different sort of thing with respect to a fixed observer in one frame. Reality is quite plastic and absolutely unlimited. It is only our own rigid heads that have been made of solid concrete.

Specifically, materialization of thought objects, by three approaching orthogonal rotations, exists. Similarly, dematerialization of an object, by three receding orthogonal rotations, exists. In such a case the dematerialized object appears the same as a thought object or virtual object.

A perfectly valid mechanism thus exists for tulpoids, materialized thought forms. All that is needed is a sufficient virtual state collection mechanism.

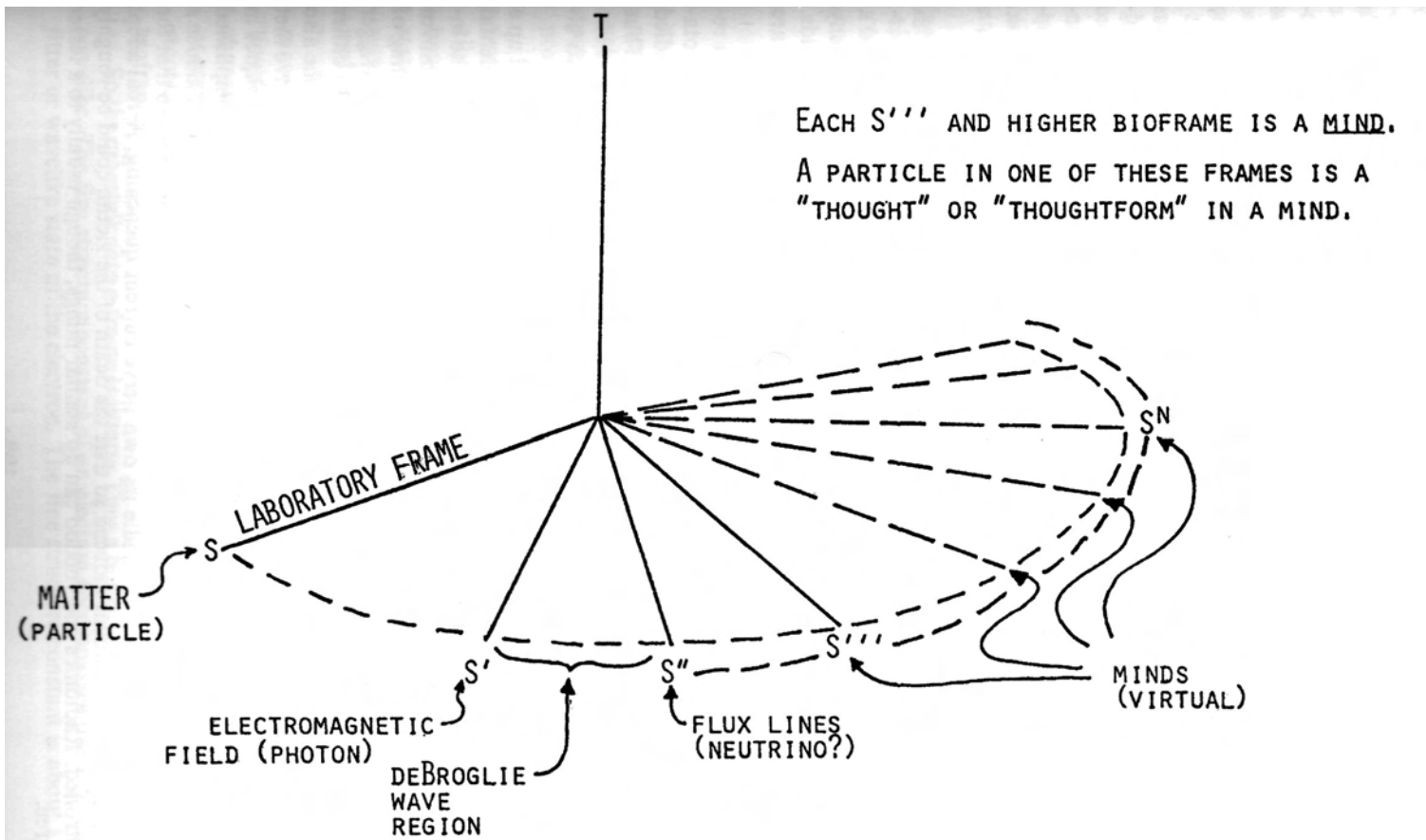

Fig. 20. Clustered orthogonal worlds

Note that an orthogonal rotation in an approaching manner is automatically accomplished by sufficient coherent collection in the remote frame. There is a finite collection threshold between two orthogonal hyperframes. Sufficient collection in one frame (by a tuning or directing mechanism in a third frame) breaches the threshold in the collection frame and the collected or quantized entity automatically appears in the next frame closer to the tuning mechanism's frame. The process may then be repeated. If sufficiently repeated, all the intervening thresholds are breached and full materialization of the object in the observer's frame (tuning frame) occurs.

By this process an object may be kindled from a remote frame to one that is less remote. Two successive applications of kindling turns thought into electromagnetic field. This is how thought photography is accomplished, and the talented individual who accomplishes it is simply cyborged to the camera film grain in an inceptive cyborg device. Many such examples, including some deliberately accomplished on demand by the study group in which I am included, are given in this book. Three successive kindlings turn a thought object into a materialized object, a tulpoid.

Such a materialized thought-object may be of an inert object or of a living, breathing, biological being. The model we are working in has eliminated any superficial difference between living and nonliving because it is a four-law model. And a materialized living being will be just as real and physical and functional as any other person on this earth. Ultimately, that is all that we ourselves are — tulpoids. Nothing exists but the thought of the infinite creator, so to speak, and we are simply part of that thought.

The coherence in multiple stages necessary to accomplish kindling is often referred to as *tuning* in this book. Tuning sufficient to enable two orthogonal rotations results in thought turning into electromagnetic field or light. Such a kindled field may be additive or subtractive to existing electromagnetic fields. Thus kindling can cancel an electromagnetic field that already exists, or it can create one where none previously existed, or it can shape, modulate, or change one which already exists.

Kindling can also wipe out the charge on a charged particle, or it can build up a charge on an object which previously had no electric charge. It is not accidental that Kulagina, when performing psychokinesis in the laboratory, first causes the induction of an electrostatic field on a nonmoving object. Then the object moves psychokinetically. In a similar fashion, she has stopped a frog's heart; kindling of the type to quench electric charge would of course eliminate the electrical trigger signals in the muscles of the heart, rendering it inoperable. This could mean either cessation and paralysis in a moderate case or total death in a drastic case. She also on one occasion demonstrated the ability to stop a living human heart. I have met other people who could do something similar. One of the great secret techniques in certain Oriental martial arts was the death touch. This could only be accomplished by certain rare adepts; with a light touch of the hand or fingers, they could induce a charge of bioenergy into and onto the acupuncture system of the body, so that the body itself began to slowly kindle its own nerve current quenching. A real adept could control the amount induced so that the death of the victim could be roughly controlled. Radionics and voodoo can do similar things, though usually to a lesser degree.

There also exists a precise mechanism for metal bending; the destruction of the charged particles (for the protons in the nucleus and the electrons in orbit, or even for just the protons in the nucleus) converts the particles in some atoms to neutrinos, which then vanish in the distance without interaction. Thus localized areas in strong metal can be kindled and made quite plastic from thought energy alone by one who has developed this skill. And the kindled areas will give every indication of having been subjected to extreme heat or unusual forces of a sort not encountered in normal metal bending or fracture. Also, the inceptor who is bending the metal and the metal itself are cyborged together into a single inceptive cyborg mechanism. Therefore the metal will often continue to bend even after laid down, because in the cyborg kindling is still occurring.

Furthermore, metals that exhibit unusual physical characteristics, such as nitinol, can change those characteristics dramatically by kindling. Also, an electrostatic field can be directly kindled in and induced on an external object, and an electric field or electromagnetic field can be induced in its surrounding space to interact with it, accomplishing psychokinesis of the object.

Or thought energy can be kindled in the hyperfield fluxes of an ordinary magnet. A magnetic compass needle can be moved by mind or a magnetometer can be affected, even through a superconductive Faraday shield. After all, the effect is rotating into our three-dimensional space from outside it, so shielding is of little consequence except where it interferes with tuning.

## CROSSTALK BETWEEN MULTIPLE REALITIES

In Figure 21, I show that phenomena in all the hyperframes crosstalk. A moving object in frame  $S$  possesses a slight rotation, hence it projects a tiny component into frame  $S^1$ . This  $S^1$  component, however, is still dynamic and has a small velocity in  $S^1$ . Hence it also is slightly rotated and therefore has a crosstalk component projected into frame  $S^2$  with a velocity there. Having finite velocity, this projection in turn has a rotation and projects into the next higher frame, and so on.

Thus any changing entity in any frame crosstalks a tiny amount into any other frame. In a frame  $S^n$ , the crosstalk from a change in any other frame  $S^p$  is normally so small as to be virtual, hence nonobservable. Coherent virtual crosstalk, however, integrates and can breach the threshold between virtual and observable state. It is in fact possible to show that what we call a mass in  $S$  space is simply the sum total of the crosstalk in and out of a localized region  $L^3$  of  $S$  space, the localized region being the mass in question.

Another point to notice is that most fundamental particles in a frame rarely move with constant velocity. Instead, they normally accelerate and decelerate continually. Thus the actual velocity vector of one of these entities is continually changing, usually quite erratically. But for microscopic particles in regular atomic or crystalline formations, the change pattern is quite regular. At any rate, the constant changes on the velocity induce a jitter component on its crosstalk into other bioframes.

So the crosstalk into a frame is jittery. Thus a fundamental particle is jittery or wavelike. The fine structure constant of an electron encompasses this hyperspatial jitter or wavelike state of the electron. The fine structure constant is about  $1/137$ .

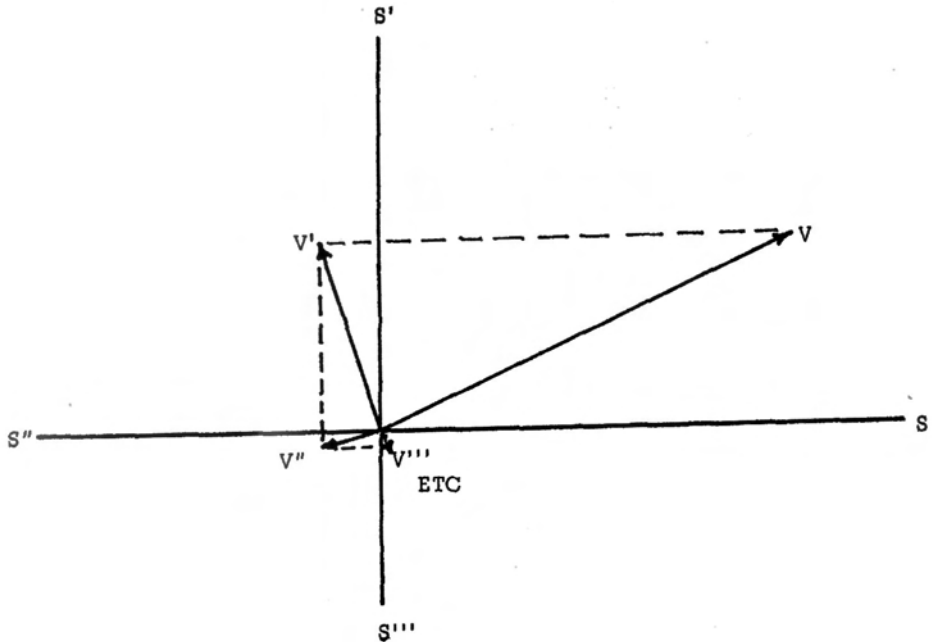

**Fig. 21. Crosstalk between multiple realities**

Thus an electron actually spends about 1/137 of the time in hyperspace.

So, because of jitter, an object is partially in every hyperframe a minute but finite part of the time. So are all minds and mental objects, and so are all virtual objects. For a fundamental particle, the fraction of time that one quantum of action pervades another frame may be referred to as the identity coefficient.

The identity coefficient varies; it is the photon interaction that time differentiates, quenching time and separating the bioframes, and this interaction is not a linear operator since the intensity of time differentiation is a rather complicated function of photon frequency.

At any rate, for an electron in orbit in an atom (or for any other electron, for that matter) there is thus a small but finite probability that the electron may be at any given position in the universe when its detection occurs. In other words, there is a finite probability of collecting an electron at any point in the universe, and the collection may be made from multiple points simultaneously. We can actually collect the same electron twice, so to speak! Or even a million million times.

The probability of detection of an electron at a given position may be directly expressed as the fraction of time that the electron actually spends there. And this fact may be used to develop a holographic coherent collection scheme that can directly amplify particles. Thus a so-called free energy device, which in one sense is just a tap into the zero point energy of vacuum, can be built. And it has been built, by Moray and by others. The jitter and crosstalk make it directly possible.

## **BIOFIELDS: AND MAVERICK WORLDS**

Figure 22 shows a convenient list of how objects appear in different frames. This schema, selected from Everett's many-worlds interpretation, allows modeling of life, death, mind, matter, and psi. It also allows one type of field to be ortho-

BIOFIELDS: TIME-CLUSTERED ORTHOFRAME			
<u>Present Name</u>	<u>n = Number of Orthorotations</u>	<u>Biofield</u>	<u>Dimensional Intersection with Lab Frame</u>
Laboratory Frame	0	0th	3-D
Electromagnetic Field	1	1st	2-D: $\nu = C$
Virtual Photon	$1 < n < 2$	Between 1st and 2nd	Mix of 2-D: $\nu = C$ and 1-D: $\nu = C^2$
Bare Neutrino (candidate)	2	2nd	1-D: $\nu = C^2$ (but flows in photon)
Space-point; mind, thought	3	3rd	0-D, $\nu = C^3$ occupies time, not space per se. Flows in neutrino, thus in photon
Space-point, mind, thought	$n > 3$	nth	Same as 3rd biofield. All hyper-spaces are only 3 orthorotations away in nonlinear hyper-space

**Fig. 22. Biofields: time-clustered orthoframes**

rotated and turned into another kind. Such orthorotation demands correct time synchronization, rather than brute force energy application. In fact, orthorotation is energy-conservative for a single orthogonal turn.

Even the strangest conceptions and most fantastic possibilities have their own assigned realm of concrete reality. These are referred to as maverick worlds.

Note that all possibilities — everything that has happened or could have happened, and everything that will happen or could happen — are real and exist concretely in their separate orthogonal universes. The same is true for all thoughts and thought worlds, and all possible thoughts and thought worlds.

By proper coherent tuning, an *object* in one of these orthoframes can be orthorotated into our own frame and objectified, and that is what the Tibetan monks call a tulpa, an objective materialization of a thought form. The tulpa will hardly ever be closed entirely in phase, however, and so it will almost always be unstable. UFO's, angels, and imps go away. But the materialization of one of these can be entirely objective and perfectly objective traces can be left, such as photographs, broken limbs, scorched asphalt, indentations, and depressions in grassy fields. Any thought object can be so orthorotated and objectified. Beings, religious figures, angels, fairies, imps, UFO's, and monsters can all appear.

## HYPERFIELD FLUX IN A MAGNETIC FIELD

In the conventional experiment to determine the pattern of a magnetic field, iron filings are sprinkled about a bar magnet on a piece of paper. As shown in the top drawing of Figure 23, the iron filings form a symmetrical pattern. Further, the only apparent circulation pattern is from one pole to the other. Each flux line is closed, going through the magnet from one pole to the other and out of that other pole, bending back through space to the first pole. Every flux line therefore goes through both poles.

However, each little iron filing is actually quite static; it does not move at all. It does not change with respect to either time or position. It is therefore integrating any higher sinusoidal component that is changing with respect to time and length. The characteristics of the orthodox picture that emerges are prescribed by Maxwell's equations of electromagnetic field.

If we tape the bar magnet to the face of a color television tube, the magnetic field is now being scanned or probed or sampled by a moving electron beam, which reacts with the magnetic field of the bar magnet. This electron beam is changing its position with respect to time and length, and it therefore differentiates the magnetic field. The hyperspatial "ripples" in the magnetic field now are not integrated exactly to cancel, and so a small deviation from each flux line will be detected by the differentiating beam. Slight deviations will cause a color change, and so the hyperspatial flux now becomes evident on the television screen. The lower drawings show the rather unusual, nonsymmetrical pattern that emerges.

The equations for these hyperfield fluxes should be obtainable by differentiating Maxwell's equations twice more, yielding fourth order equations. These equations should be the much sought-after equations of prana, chi, ki, ectoplasm, bioenergy, bioplasma, odic force, etc.

Note that the hyperfield circulation goes into the north pole and pours out of the south pole. A living organism exposed to the north pole, end on, will have its own bioenergy sucked out by the magnet, and its own flux will diminish somewhat. Exposed to the south pole, end on, it will have its own bioenergy increased by the bioflux pouring from the magnet. This explains why many experimenters who have extensively tested the influence of magnetism on growing plants have found that the north pole inhibits and the south pole stimulates growth and health.

The hyperfields are fundamental fields rather than electromagnetic fields; they collect coherently and kindle *into* electromagnetic field, creating it or destroying it.

## LIFE AND DEATH

In Figure 24 I present an overall schema for life and death — and for reincarnation as well.

An infinite number of hyperfields or bioframes are shown as  $S, S^1, S^2, S^3$  etc. The frame  $S$  is the ordinary laboratory frame — the physical spatial world we live in and observe. The frame  $S^1$  is the electromagnetic field, the frame  $S^2$  the linear or flux frame, and  $S^3$  the first "mental" or "virtual" frame. Also, all higher bioframes have a connective path to the  $S$  frame of only three orthogonal rotations (not shown). Thus only three orthogonal turns separate  $S^n$  and  $S, S^k$  and  $S, S^j$  and  $S$ .

In frame  $S$ , note that physical body  $A$  has a coherent crosstalk link with the entire frame  $S^n$ .  $A-S^n$  thus constitutes a living biological system; in this case, let us say, a human being. Likewise,  $B$  and  $S^j$  have established a coherent crosstalk loop.  $B-S^j$  thus also constitutes a living biological system; in this case, let us say, an opossum. These two examples are incarnated living systems (incarnated minds).

In fact, this is a great oversimplification, as the reader will realize at once. We really should consider all the groupings of  $A$  — the organs, the structures, the cells, the internal cellular parts, etc. — as separate but coordinated  $a_i$ . (And similarly with  $B$ .) Each of these  $a_i$  must have a correspondent  $s^n$  subworld of  $S^n$ , much like



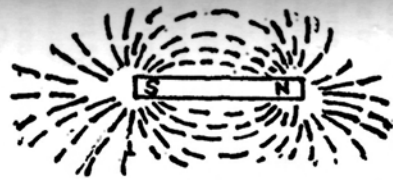

CONVENTIONAL PICTURE,  
IRON FILINGS SPRINKLED  
ABOUT A BAR MAGNET ON  
A PAPER.

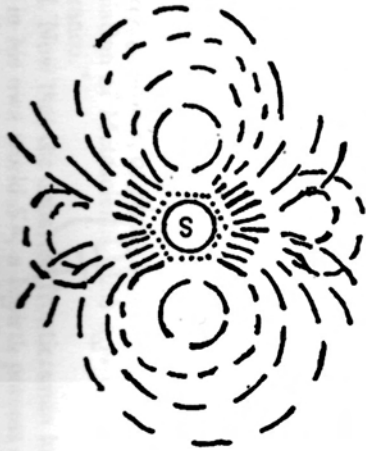

HYPERFLUX  
CIRCULATIONS

NOTE STRONG  
HEXAGONAL PATTERN  
AND TWO PRIMARY  
VORTICES

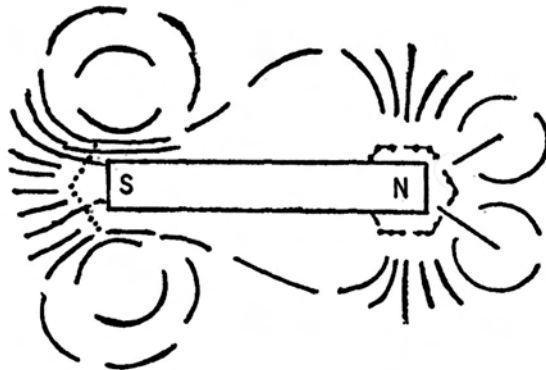

HYPERFLUX CIRCULATIONS  
FLUX PATTERNS ARE NOT  
SYMMETRICAL, POLE-TO-POLE

NOTE STRONG HEXAGONAL  
PATTERN IMMEDIATELY  
ADJACENT TO NORTH POLE.



HYPERFLUX CIRCULATIONS

NOTE STRONG  
HEXAGONAL PATTERN  
AND FOUR PRIMARY  
VORTICES

**Fig. 23. Hyperfield flux in a magnetic field**

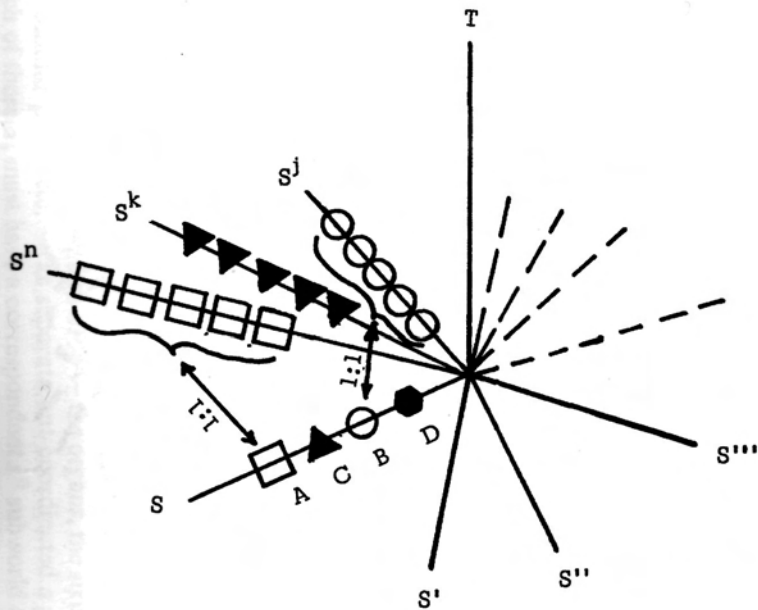

$A \leftrightarrow S^n$  is a living system.

A is the physical body, the incepted mass.  
 $S^n$  is the mind.

$B \leftrightarrow S^j$  is also a living system.

To S, D is inert; i.e., D is not preferentially incepted.

To S,  $S^k$  is a "disembodied mind." I.e.,  $S^k$  is "dead," since it is not preferentially incepting its former body, C.

Whenever a proper retuning body, say E, appears in S,  $S^k$  will reestablish a coherent crosstalk with E. This constitutes "reincarnation" of  $S^k$ .

**Fig. 24. Life and death**

the fine structure of atomic energy levels. But here I am simply outlining the major schema.

At any rate, let us now examine body  $C$  and hyperworld  $S^k$ , which formerly were one-to-one coherent in crosstalk, but are no longer so.  $C$  represents, let us suppose, the body of a frontiersman in 1830 who has received an Indian arrow in his breast, piercing the heart and destroying the ability of the body to coordinate the  $c_i$  to each other and to the inceptive channel from  $S^k$ . With the loss of coherence, noise begins to destroy the channel; thus  $S^k$  is now a "disembodied mind," and  $C$  starts to become a decaying corpse. The various  $c_i$  of course lose coherence at differing rates, and so the fine structure channels to the  $s^k$  also lose coherence at differing rates.

Finally all  $c_i - s^k$  coherence is lost, and the frontiersman is then "dead." The mind  $S^k$  is now disembodied — and also probably quite disturbed or "noisy" because of the variance in disintegration of the  $c_i - s^k$  loops. One might say that the mind is somewhat "detuned" by the whole affair. However, "death," in the sense of total loss of mind and personality, has most certainly not occurred. All that has occurred is a lapse into a disembodied, and perhaps somewhat confused, state.

And the disembodied mind finds itself in its own deep, unconscious world constructs. If a person has been unconsciously Christian in a very deep, fundamentalist sense, and in his own mind has also been a "sinner deserving of hell," then he will actually "lift up his eyes in hell," in his own world tuning. And that world will be physical and real — as real and physical as this one — but it will operate by different physical laws, just as dreams operate by different physical laws. These relations and laws are prescribed by the person, either consciously or unconsciously. The devout Mohammedan is quite likely to find himself after "death" in the delightfully chauvinistic paradise he believes in.

And so the Catholic practice of praying oneself out of purgatory is relevant, for if that belief-structure is firmly fixed in the deceased's deep unconscious, then it will happen; he will simply change his world construct in accord with the effort made on his behalf.

And the ancient Tibetan practice of giving instructions to the deceased as to what to expect and where to go is also relevant, for during the time that the major channel  $C-S^k$  is lost but many of the  $c_i - s^k$  are still functioning, the deceased is still in contact with frame  $S$  and can heed those instructions.

Certain clairvoyants and skilled psychics can also project part of their mind vision into  $S^k$  and see the status of the deceased. In some cases the deceased will have so strongly retained mental structures analogous to physical structures and localities (or persons) in frame  $S$  that continual small crosstalk channels breach open by tuning resonance to those localities, structures, or persons. With a little inceptive assistance from one or more sensitive persons, an "appearance" of the deceased at the locality, structure, or near the person can take place. Much psychic, ghost, or spiritualist activity is due to this effect. So indeed is the concept of earth-bound spirits. Here again, an advanced adept can erase the psychometric pattern attached to the locality, structure, or person and thus eliminate the phenomena. In the American Association of Metascience, such a resolution is part of an overall process called "clearance."

But this is not all. Now that the departed frontiersman has been cleared, so to speak, and is snugly in his own world  $S^k$  rebirth process still awaits him. As I

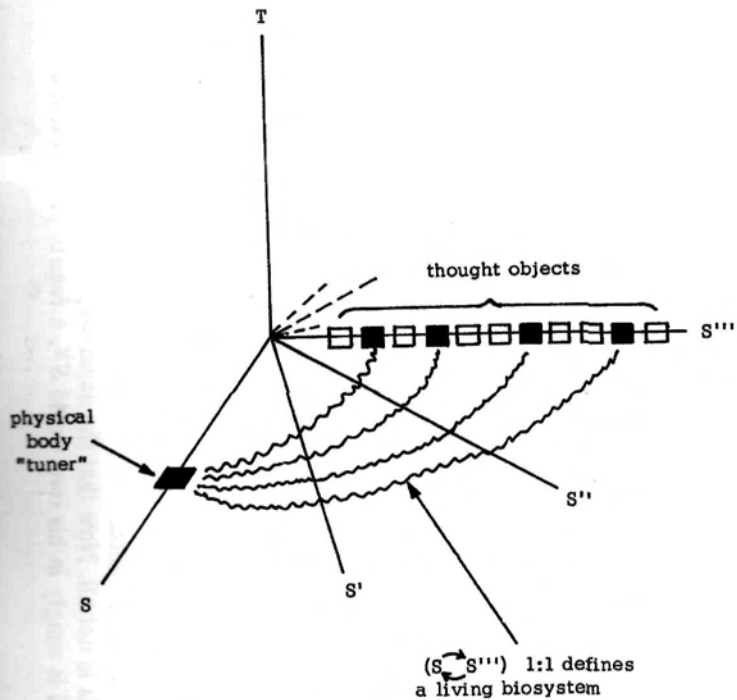

A. A LIVING BIOSYSTEM

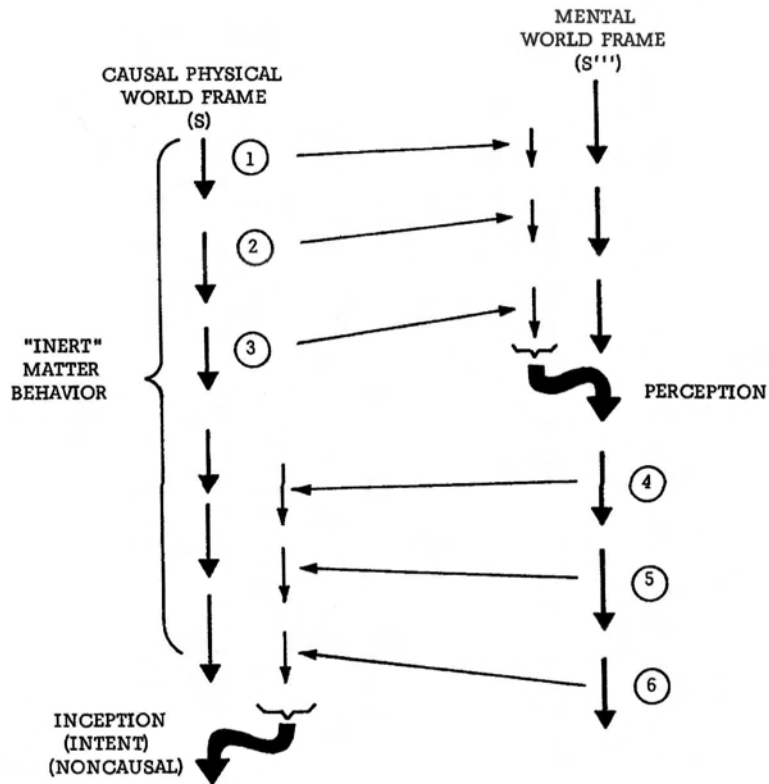

B. THE FUNCTIONING OF TIME AND CONSCIOUSNESS ARE MUTUAL CREATORS OF EACH OTHER.

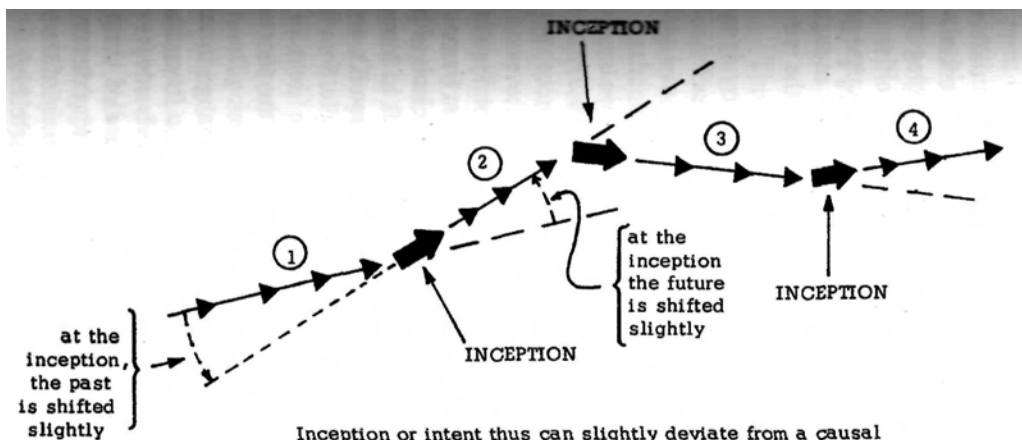

Inception or intent thus can slightly deviate from a causal trajectory. Over sufficient collections of physical changes, "intentional behavior" or "limited free will" emerges. However, it is only a very small modulation of causal inertness -- and its smallness accounts for human "physical limitations."

C. CHANGING THE PAST

**Fig. 25. Consciousness, life, and intent**

have pointed out elsewhere, every particle of mass is simply a pattern of change in the universal orthorotational flux between hyperframes. (This, after all, is no more than a slight extension to general relativity.) When the proper physical tuning mechanism, say  $C^1$ , again appears in the  $S$  frame, then a resonant coupling will automatically establish itself in the flux between  $C^1$  and  $S^k$ , and the disembodied, confused mind of the frontiersman will simply be coupled again to a new physical body pattern. This happens at the instant of conception, for the genetic pattern — the complete tuning pattern — is present at that instant. The coupling is quite tenuous at first, and increases in degree as the embryo develops.

So reincarnation has a place in my schema. We will see, however, that it differs slightly from the classical concept, because with developmental work the frontiersman can change the makeup of  $S^k$  and thus his predisposed tuning. Changing the tuning also causes rotational displacement of  $S^k$  among the infinity of infinities of mind worlds available. Thus the past can be changed; in fact a person can change who he is the reincarnation of, simply by changing his mind tuning with enough development. Therefore more than one living person can be, for example, the reincarnation of Napoleon.

And in fact the cycle of rebirth can be broken completely — simply by dying with a totally detached mental framework. The cessation of all tuning attachment results in a broadened  $S^k$ , which now is structureless, hence all-structured and part of universal Godness.

But the major point is that all this can be modeled physically. And there is only life; absence from one place still leaves presence in another. Absence from *any* and *every* one place exclusively leaves presence at all places, each nonexclusively.

Death, where is thy sting?

In diagram A of Figure 25, I summarize what constitutes a living biosystem. Here we can see that body (physical) changes from the biosystem's body in frame  $S$  crosstalk successively through frame  $S^1$  and  $S^2$  to  $S^3$ . Also, physical changes in frame  $S^3$  actually constitute mental changes to the biosystem's body back in frame  $S$ . These mental changes must crosstalk successively into frame  $S^2$ , frame  $S^1$ , and then into frame  $S$ . This entire process — from frame  $S^3$  to  $S^2$  to  $S^1$  to  $S$  — is referred to as *kindling*.

In diagram B, we observe this process a little more closely. Here, the shorter straight vertical arrows are virtual state changes kindled from the opposing frame. The longer straight vertical arrows represent observable quantized change in the particular frame, these changes being produced by ordinary inert physics laws. The curved double-lined arrows represent quantized change kindled into the frame from the coherently superposed virtual changes that have steadily been kindled there.

Thus there is a kindling time delay in the causal  $S$  frame before will or intent sets of changes from the mind-frame  $S^3$  can induce an input into the physical body of the biosystem. Correspondingly, there is a kindling time delay before a perceptual change in  $S^3$  from the changes in  $S$  can occur.

The horizontal arrows represent the flow or flux of kindling crosstalk between the two frames. It can be seen from this diagram that consciousness — the thread of the relation between consecutive changes in the two respective frames — and time are identical. (Recall that each inert physical change in  $S$  that is not kindled from  $S^3$  is actually randomly kindled from all the other mind-frames.) Thus time and mind are identical. Consciousness is simply the functioning of coherent cross-

talk between a mind frame and a physical body in frame  $S$ . Further, each biosystem's consciousness has all other consciousnesses interwoven with it. The other living consciousnesses input into other physical bodies in frame  $S$ , and these physical bodies interact in frame  $S$ . The other dead consciousnesses input into frame  $S$  - into each body as well as into all other inert matter — in a noncoherent, randomized manner. Thus the entire universe of universes is totally in communication with each part of itself, continually.

In diagram C, I show that incepting a change from pure causality changes the past; in this case, the past is causally inferred or projected backward from the new vectorial direction. However, because inception into frame  $S$  is a very small effect, the biosystem's change of its past is so slight that normally it is not noticed. Inception of course also changes the future slightly.

## THE HOLOGRAPHIC HYPERCHANNEL EFFECT

This effect is based on the concept that a human being must accomplish a minute inception (psychokinesis) onto his physical system. Specifically, he must incept the movement of three or four electrons in the brain. This constitutes an input signal to his ordinary physical system, which is then treated like a complex servomechanism. The gain of this servomechanism is rather high, being able to transform or amplify the movement of several electrons into powerful movements of the entire body. The inceptive effect cannot be explained by ordinary physics, which account for the servomechanism gain only. Once the input signal is generated, however, the rest of the amplification and action are viewed as being properly described by the ordinary physics of inert matter. Thus the human is viewed as largely servomechanistic and mechanical, but guided and directed by the non-physical, which affects the physical in a minute fashion sufficient to constitute inputs to the ordinary physical system.

Our purpose here is to show that, given this single small inceptive effect, we can eventually approach the mastery of space and time for a linkage of sufficient number of human brains and minds into one single superbrain and supermind.

From the multiplicity of orthogonal frames permitted by Everett's many-worlds interpretation of quantum mechanics, we now select an infinite set of clustered three-dimensional spatial frames, which all share a single time dimension. Using one frame as a laboratory reference frame, the other spatial frames may be characterized as having one, two, three, or more orthogonal turns away from the laboratory frame. These succeeding orthogonal frames are variously called hyperframes, bioframes, orthoframes, hyperchannels, orthoworlds, etc. A particular set of material phenomena in one of the orthoframes is referred to as a biofield, hyperfields, or orthofield with respect to the laboratory frame.

In Figure 26 I represent each brain by a triangular symbol, and consider it as an amplifying device having a gain of  $A_0$ . For simplicity the inceptive input signal is represented as  $E_i$ , since in moving an electron, a voltage must be induced. For simplicity I also show the brains as a linear array lying in a straight line. The distance  $L$  separates each brain, and here  $L$  is assumed constant for simplicity.

Two factors must now be realized: (1) The first hyperchannel operates in the realm of the ordinary electromagnetic field, although this realm is seen in a differ-

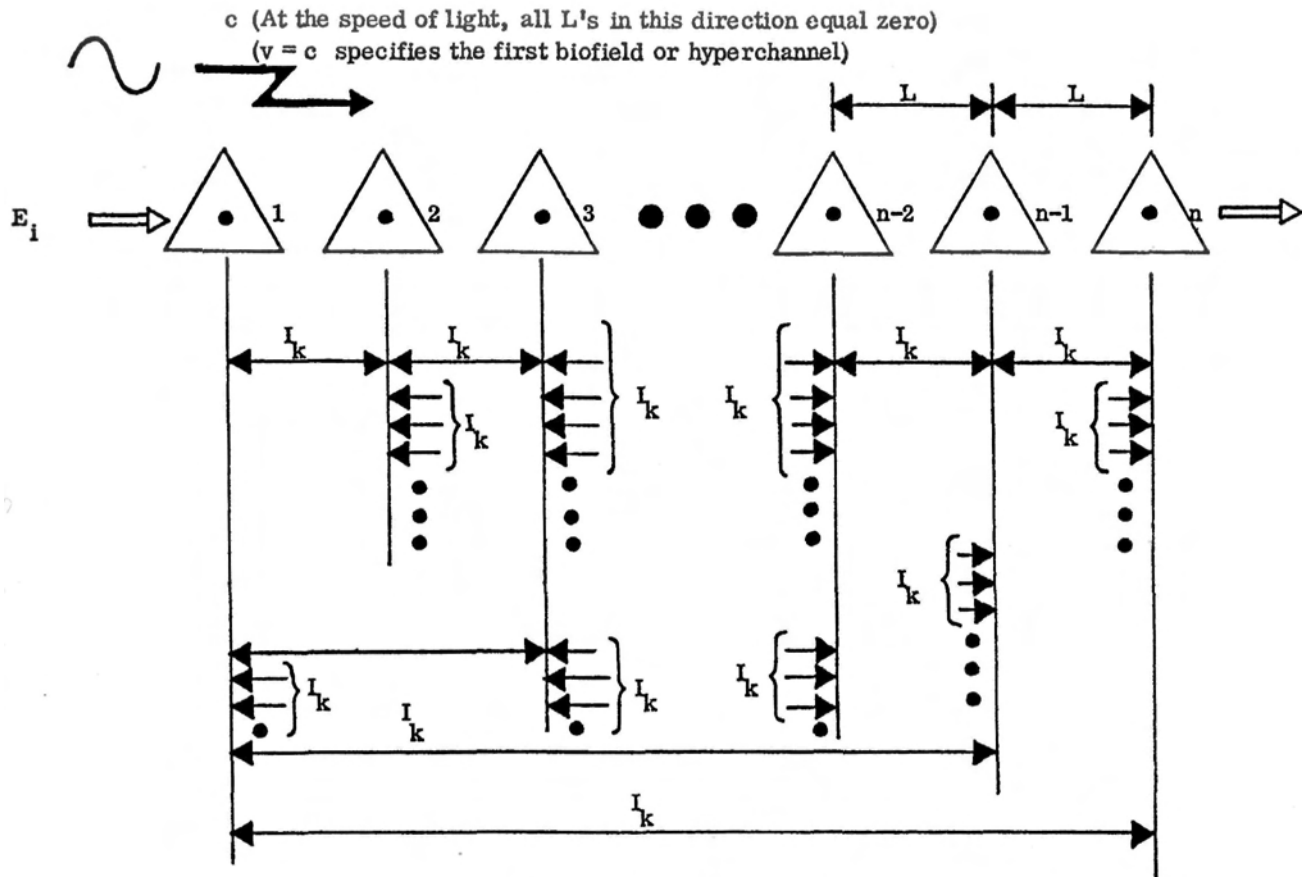

**Fig. 26. The holographic hyperchannel effect**



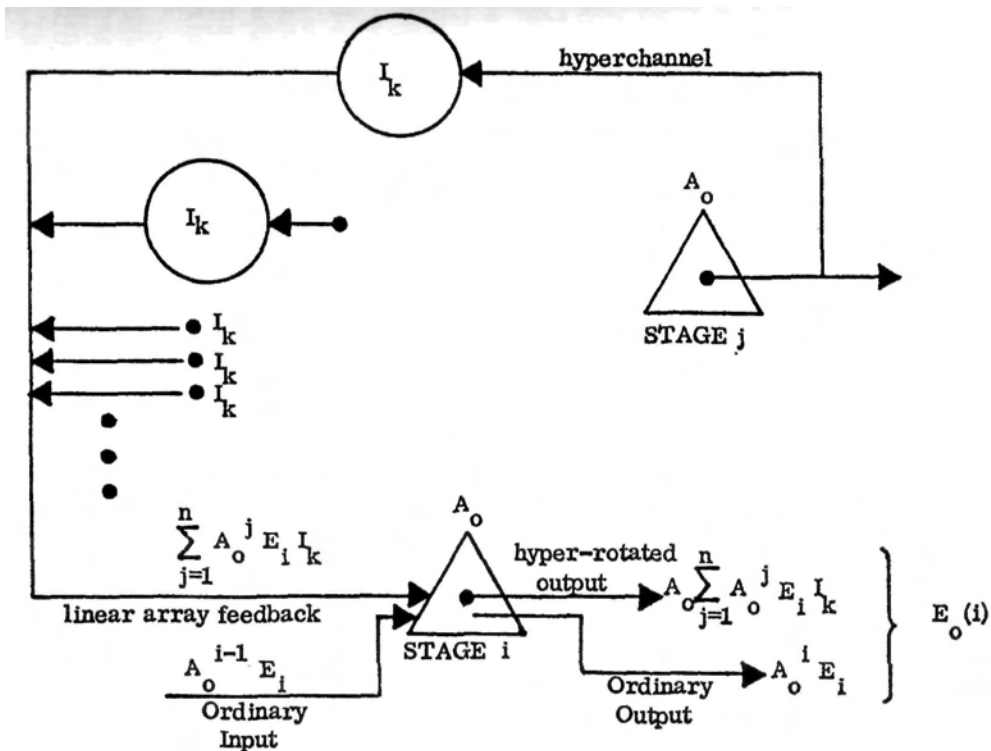

Fig. 27. Output of stage  $i$

ent way, i.e., we visualize a photon as an ordinary particle of three-dimensional matter, resting in a three-dimensional spatial frame (hyperframe) that is orthogonally rotated spatially in higher dimensional space, at  $90^\circ$  to the observer's spatial frame. The hyperframe and the laboratory frame share the same fourth dimension, time. (2) At the speed  $c$  (which determines the hyperframe in the first place), all  $L$ 's are zeroed out, by the equations of the special relativity transformations. Thus one may view (hyperview) each triangle (brain) as superposed on each other triangle (brain). Furthermore, there exists a very small, finite, nonzero probability that the state of one triangle coincides exactly with the state of another superposed triangle, at any given small increment of time. This probability corresponds to a direct fraction of identity between two triangles, since time is stopped along the chain. At any given small increment of laboratory time, any given triangle has on the average a small fraction of identical coexistence with any other triangle. This identity fraction is labeled  $I_k$  in Figure 26.

It is important to note that, for a very small fraction of time, the triangles coincide with each other; i.e.; for a small fraction of time the existence of one triangle is totally holographic. This fraction totally violates the ordinary conservation of energy, which is applicable only to a single channel system. The hyperchannel represents a second channel, an identity channel, and in this channel an object can be in multiple places at the same time. If the triangles, regarded as operating processes, are even slightly coherent, then multichannel communication and holographic transmission of a single state-energy into multiple state-energies occurs through the hyperchannel — usually in the virtual state.

Figure 27 shows the setup to calculate the gain of the hyperchannel amplifier. These calculations yield, for the output of stage  $i$ ,

$$\frac{E_0}{E_i} = A_0^{n+1} I_k.$$

When no ordinary electrical input exists,  $A_0^n = 0$ , and the virtual state amplification is thus

$$\frac{E_0}{E_i} = A_0^{n+1} I_k.$$

This mechanism holds the secret to the tapping of zero-point energy and free energy devices. It is also the hidden variable theory that causes a radioactive nucleus to decay. Since radioactive nuclei interact through hyperspace, the amount of radioactivity in a given sample is an exponential function of the number of radioactive nuclei present.

It is also a mechanism which can directly amplify the virtual-mental state into observable state. It is the fundamental mechanism that causes kindling and thus orthorotation. It can be used to materialize tulpas, and accomplish psychokinesis, remote viewing, clairvoyance, precognition, etc.

## MIND LINKAGE

The entire human species has been developing and evolving, not just the individual person.

The development of life in a biosystem may be divided into seven stages: (1) the development of planet, primordial atmosphere and ocean; (2) the appearance of

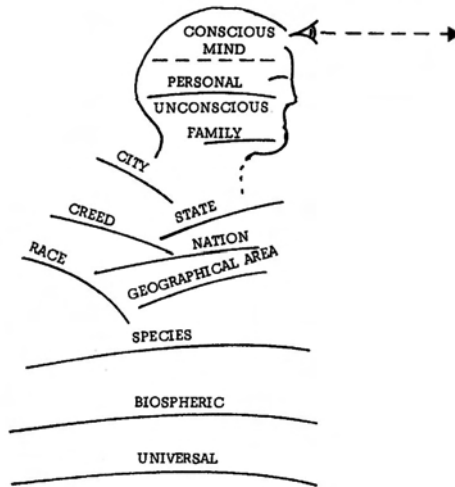

**Fig. 28. Layers of unconsciousness**

amino acids; (3) the appearance of the self-replicating supermolecules; (4) the formation of one-celled organisms; (5) the formation of multicellular organisms; (6) brain linkage of an intelligent technological species; (7) total omeganness or godhood.

Two major types of behavior are involved in living organisms: genetically programmed behavior and genetically unprogrammed behavior. Thus one mode of behavior control of an organism is nonadaptive and the other mode is adaptive or learned. Intelligence may be viewed as the ability to adapt behavior, and increased intelligence represents a decrease in the portion of behavioral control that is genetically programmed or "hard-wired."

We may further speak of two types of intelligent species: those that possess a tool-using member and those that do not. The first is a *technological* species, while the second is *nontechnological*. By this classification, man is a fifth-stage, technological species.

The intelligent species, being relatively deprogrammed, is highly adaptive and competitive, and many of its species-specific checks and balances are reduced or eliminated. Because of the use of tools in its internal competition, the technological species continually increases the ferocity of its internal competition and its deadliness to itself. Thus as the power of its tools increases, the technological species carries the seeds of its own destruction within itself, and it will eventually destroy itself unless it advances to the next stage, the linked-mind sixth-stage being.

The sixth stage consists of the linkage of all individual brains in the species into one single superbrain, producing a superbeing having absolute control of space and time. A technological species is necessary to accomplish linkage and produce a multidimensional, eventually nonphysical, superbeing. When the technology is sufficiently advanced for linkage to be developed, the power of the tools is so great that self-destruction is imminent. Thus an advanced technological civilization is near linkage and also near Armageddon, and in either case it vanishes as a limited, three-dimensional species of the fifth stage. This accounts for the notable absence of a technological species similar to man in man's universe.

# ANGELS, IMPS, AND UFO TULPAS

If we realize that each of us has his own mind world, an  $S^3$  frame with respect to the  $S$  frame physical world, but separate from each other  $S$  frame mind world, then we see that, if we take common forms that are in the minds of all human beings, it is much easier to kindle them because they can be cohered much more easily.

The common crosstalk in all minds constitutes the collective unconscious. Since the common crosstalk is in a sense a mind, and since it is connected to a "body" of many cells, i.e., of four billion humans or so, then this collective unconscious is a living, breathing entity.

Furthermore, the usual content of its mind is a great deal closer to physical phenomena that are in all minds than is a single human being's mental content. Much of what we term physical reality is in fact prescribed by the collective human unconscious. And if the collective human unconscious is changed in its conception of reality, then four billion stages start kindling with the hyperchannel effect, and immediately the new conception is physical reality.

Borrowing from Jungian psychology, let us call a form that is in each human mind an archetype. Let us also realize that there are shallower levels of unconsciousness (Figure 28) between the total collective unconscious and an individual mind. For an Irish-American there is one level defined as Caucasian, another defined as Irish, another defined as American, another defined by the larger region he lives in (say the state), another defined by his family, and another by his own personal unconscious. The levels are not mutually exclusive, but intersect across one another. At any rate, all these unconsciousness levels above the collective human species unconscious also shape, modulate, mold, and change the kindling channel that exists for a person or group. All these levels of unconsciousness are like finer and finer tuning levels to change the kindling mechanism.

An archetype that is kindled from the collective unconscious is kindled through such a mechanism of unconscious levels of tuning, and the reality format that is kindled is determined by the type of pressure and the content, biases, or tuning of all the levels between it and the conscious minds of the individuals who observe the phenomena.

All tulpidal manifestations are kindled through and by this mechanism. All of them are shaped by the multilevel unconscious tuning. All of them are caused by an unresolved conflict in the deeper unconscious layers.

Since most minds are notoriously unstable, the tuning is unstable almost always, and the tulpidal manifestation is usually fairly shortlived, usually not more than a few minutes, or a few hours.

Angels, imps, Virgin Marys, UFO's, sasquatches, Loch Ness monsters, lake monsters, sea monsters, nocturnal mystery lights, fairies, elves, devas, devils, ogres, Mothman, men in black, goblins, large monster birds, etc. are all kindled by the same process. And so are cattle mutilations. I fear that human mutilations will be next.

Any tulpidal materialization may be physically real during its stable period. It may make large tracks in the ground, operate shiplike space vehicles, break tree branches, take human specimens on board, examine human specimens, etc.

The tulpoid may appear benevolent or harmful, and it may actually be so when in the stably materialized mode. The full content of the human unconscious is there to be materialized in physical form — all the good, all the bad, all the noble, all the sly aspects.

When enough human unconsciousnesses have the idea of fairies deeply ingrained in them, occasionally a real, living, breathing fairy pops out of the collective unconscious, riding as a direct modulation on a more primitive overall human species archetype. And the fairy may do all the things expected; she may pose riddles, give gold coins which must not be examined or they will be lost, etc.

Religion can also make use of tulpoidal appearance. When Christian predecessors believed in a vengeful god, a powerful but spoiled king, they got all the manifestations of that kind of Being. When they believed in a god of sacrifice, they got a god who demanded sacrifice and thrived on it. And when many believe in angels and Virgin Marys, they sometimes actually appear. These appearances are not hallucinations; they are completely real. It is just that all possibilities are concretely and physically real in their own realms, and any of these may be tuned in to appear in this realm.

An infinite number of reality channels exists. The total instrumental characteristics, genetic, psychological, and physiological, of the observers who tune in the channel determines the noise content and the actual channel selected.

A reality is simply an orthogonal frame or world. All possible realities already exist. A channel is a set of tuned and timed orthorotations communicating back and forth between two orthogonal frames or worlds. Tuning is a complex of mind and matter, and of many unconscious levels.

For a perfect adaptation of this mechanism of coherence, any coherent signal — no matter how fantastically weak — can be raised up out of the grass and made dominant. By time coherence in the virtual state, a virtual state entity can be amplified into observable state. From sheer nothing we can produce something. And since every possible something exists in nothing and is available for cohering, we can get anything at all by this process, at least hypothetically.

## **DREAMS ARE UNRESOLVED CONFLICTS**

Everything is essentially mind. Mind forms layer after layer of overlapping zones of shallower and shallower unconsciousness (multiple simultaneous consciousness), all the way from the universal allness to the personal unconscious, and culminates, like the tip of a dagger, in each conscious mind. Figure 29 illustrates these mindlevels.

Just as the dreams of an individual show his unresolved conflicts, so the materialized tulpoids of the collective human unconscious show its unresolved conflicts. Tulpoidal phenomena thus symbolize man against himself, or one group of humans against another group of humans. The great unresolved conflict in the human species since World War II has been the Cold War. And therefore the great flaps of tulpoidal UFO activity should correlate directly to the Cold War. And so they do, as I indicate in this book. Literally we ourselves are our own "Satan," for in man's inhumanity to man, satanic evil is created inceptively. And we ourselves are our own "godform," for in man's love of his fellow men, goodness is created

Such dreams of the collective unconscious can materialize as tulpoids.

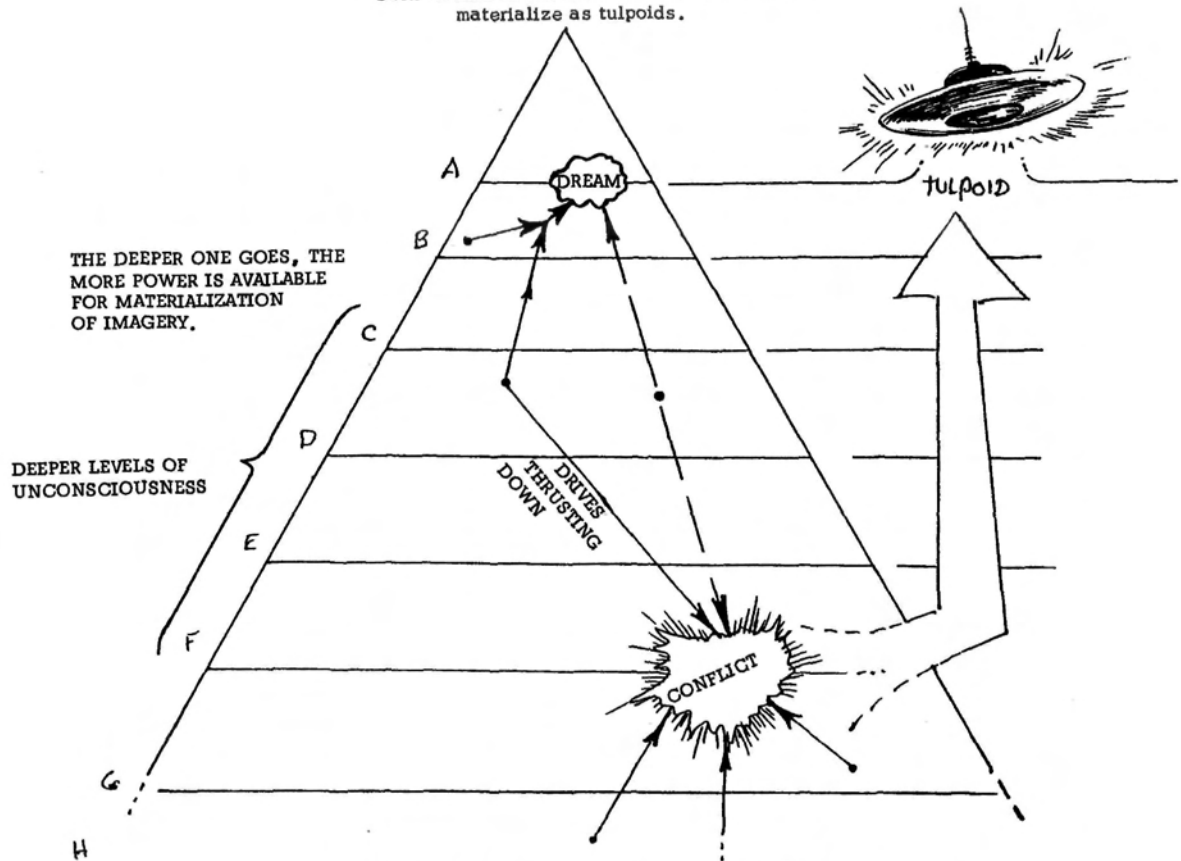
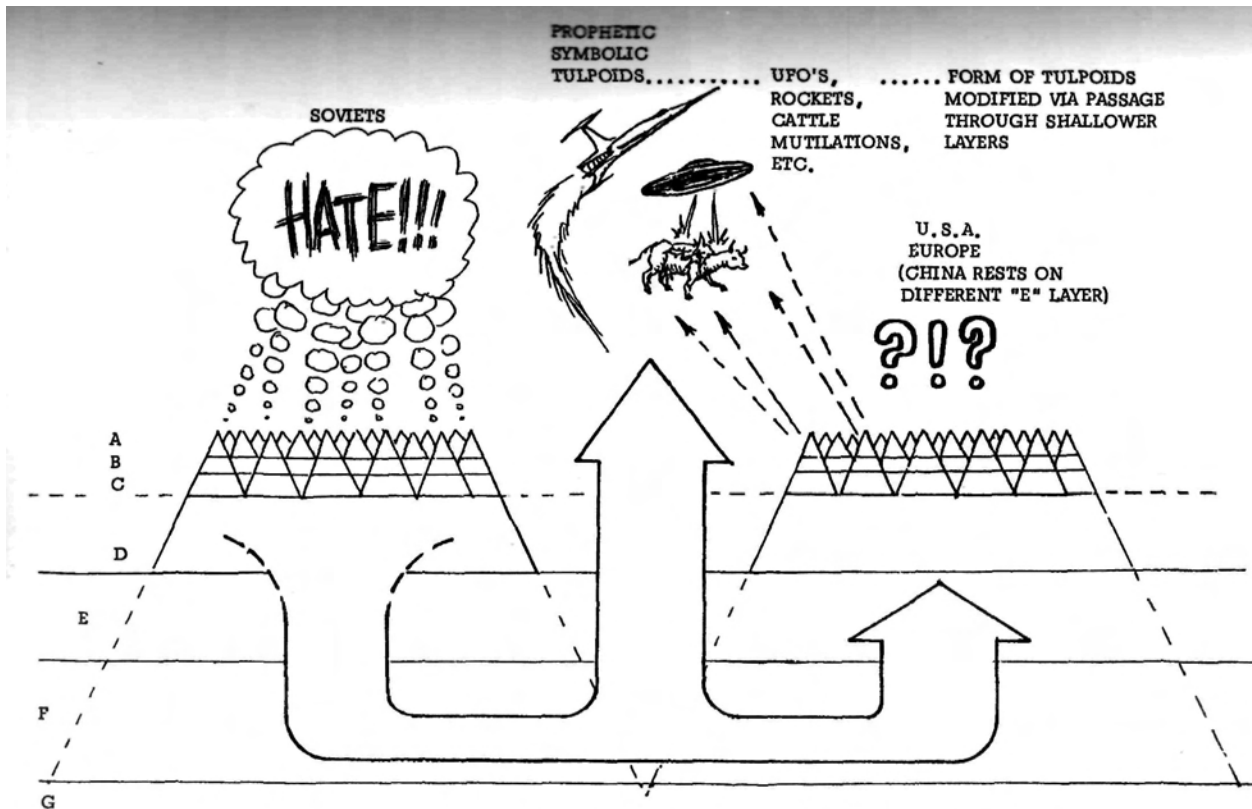

Fig. 29. Dreams are unresolved conflicts



THE PSI CHANNEL IS LIKE A QUASI-HYDRAULIC U-TUBE. CONSISTENT PRESSURE INTO DEEP LAYERS RESULTS IN UPWELLING TULPOIDS WHOSE FORM IS MODULATED AND SHAPED BY SHALLOWER LAYERS, ON THE WAY TO MATERIALIZATION.

**Fig. 30. Collective conflict initiates prophetic tulpooids**

inceptively. It is not accidental that the Avatar Jesus exhorted man to love God with all his heart and mind, and to love his neighbor as himself. It is also not accidental that a human culture seeks and "obtains" a godform or god-image consistent with its own level of understanding and belief; the resulting tulpoidal activity conditioned into the collective unconscious and the cultural unconscious, and tuned in from them, will be consistent with the cultural desires and expectations.

So in a sense we are the creators of our own reality and our own tulpoidal expressions of higher reality. But in addition to tulpoids, the present character of spacetime and dimensionality, and the very laws of the physical universe, are largely prescribed by the collective human unconscious.

## **GHOST ROCKETS AND FLYING SAUCERS: MATERIALIZED TULPOIDS**

Unfortunately, from 1945 to 1947 events occurred that caused a split among previous World War II allies and that led to the beginning of the Cold War in 1947.

Due to these events, Western nations perceived a growing threat from the Soviet Union. The resulting interplay of events, news reports, and personalities, plus the traumatic aftermath of World War II, led to strong psychological pressure on the group unconscious of the Western nations, and thence on the collective human unconscious. This pressure resulted in popouts of direct orthorotations of resonant archetypal symbols from the collective unconscious, the archetypal format being successively modified by the Western group unconscious and the progressively higher levels of unconsciousness.

The formats of the deep human unconscious were formed millions of years ago in the primitive tribal state. In the tribal warfare of those ancient days, the male went to where the action was, while the female stayed behind in the protected cave, fortress, or shelter to care for the young. Thus the male symbol was closest to the threat and identified with being there.

Furthermore, in primates the phallic symbol is the universal symbol of threat, dominance, and defiance. Dominant primate monkeys often briefly mount submissive males to show their dominant position, exposing their genitals in so doing. If the mounted male does not submit, an immediate battle ensues to determine the dominant male. Thus the phallic symbol represents threat and domination.

In the deep human unconscious, fire is a symbol of power, for with fire the species held predators at bay and began the long trek up from the jungle cave to modern civilization.

Finally, the unconsciousness of a substantial number of the Western nations had been deeply impressed by the German V-1 and V-2 rockets during World War II, for the imagination of the world had been breathtakingly fired by the surprise advent of the German rocket weapons.

Thus we would expect that in those Western countries — Norway, Denmark, Sweden, etc. — that are close to the Soviet Union, archetypal tulpoid popout materialization would have taken a male, threatening, dominant, power format. The nearest, most powerful, most resonant recent stimulus symbol in the Western group unconscious would have been the final modulation, determining the final format.



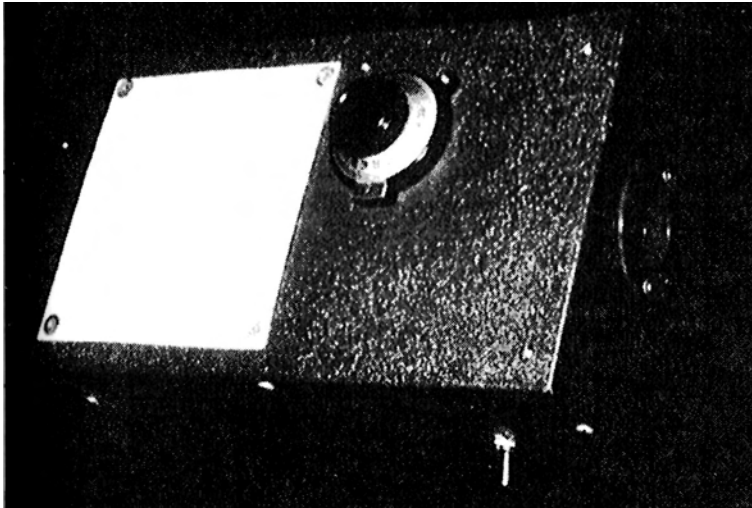

Outside showing contact plate, sample well, tuning vernier, and on-off switch.

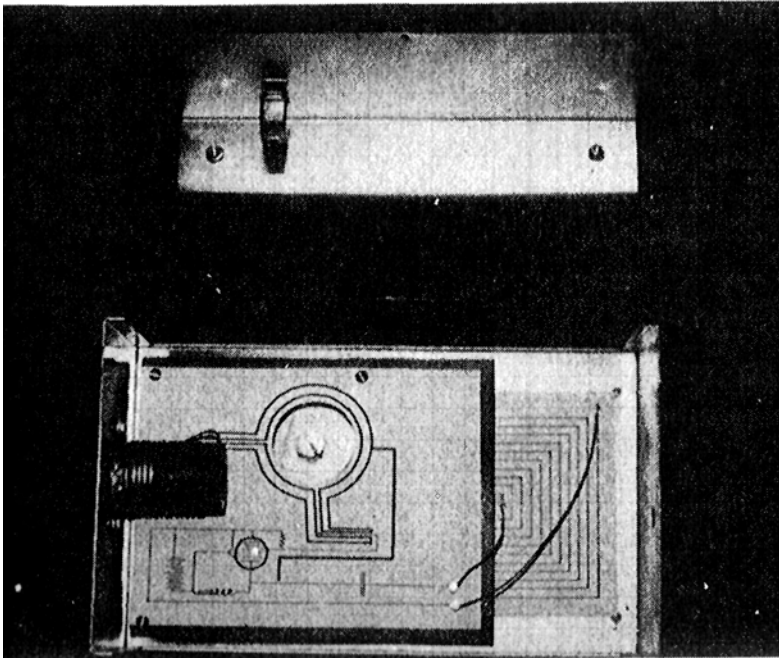

Inside, showing India Ink drawing of an amplifier schematic, used as the "amplifier."

Photo 41. Hieronymus device — second kind.

So a massive wave of "ghost rockets" from the direction of the Soviet Union appeared in the skies over Norway, Sweden, and Denmark, and other nearby European countries. (See Photograph 43.)

However, North America constituted a natural fortress with great ocean barriers to the east and west, and no strong enemy to the north or south. Therefore, a female symbol (archetype) should have been resonant and stimulated in the U.S., and so it was. In 1947, the year the Cold War began, Kenneth Arnold, flying over the state of Washington (the most northwestern U.S. state at the time, and the one nearest the Soviet Union), encountered a formation of flying saucers — the female circle mandala, dressed in modern aeronautical form. Thus was born the age of flying saucers in America.

**PART THREE**

**NEW MILITARY  
APPLICATIONS OF  
PSI RESEARCH**

# BACKGROUND TO PSYCHOTRONIC RESEARCH IN THE U.S. AND THE U.S.S.R.

In this section I will discuss some of the fantastic psychotronic weapons that have been built and deployed by the Soviets as a part of operation "Fer-de-Lance," the Soviet plan to conquer the world.

The Soviet Union has had a massive developmental program in what they call energetics or psychoenergetics (and what we are calling psychotronics) for about thirty years. To appreciate the mind-staggering weaponry that has emerged from this effort, I should point out that the U.S. developed the atomic bomb in World War II in about four and a half years; thus the Soviet psychotronic program is the equivalent of roughly seven Manhattan projects, back-to-back. With this comparison we gain a rough yardstick to appreciate the fantastic capabilities that must have emerged from the sustained Soviet program. As we will see, they are indeed mindboggling.

Ironically, most of the original theoretical work was done here in the United States, just as the pioneering work in rocketry was done here by Goddard, before the Germans picked it up and advanced it to the V1 and V2 rockets. Just as Goddard himself was once the laughing stock of the Pentagon, so the key U.S. researchers who could have initiated the psychotronic age in the West — Moray, Abrams, Reich, Hieronymus, Drown, Tesla, de la Warr, etc. — were generally ignored or prosecuted or both. Even more deadly has been the studied avoidance of any application of the basic theoretical work — which again was developed largely in the U.S. This work included the Everett-Wheeler-Graham many-worlds interpretation of quantum mechanics, and the extension of Lorentz's work by Ives, Ruderfer, and others to show that almost all modern physics — including general relativity, Newton's laws of motion, and the law of universal gravitation — can be straightforwardly derived from a Lorentz-invariant nonmaterial ether. Even though Pauli pointed out that the Michelson-Morley experiment only eliminated a material ether rather than ether per se, and although Einstein himself once proposed the use of the term ether to include dimensionless vacuum space complete with various fields, modern physics in the West has ignored the ether theory.

As Robert Anton Wilson points out, whatever you believe imprisons you. The West has been solidly imprisoned in its own orthodox view of physics, and hence has been unable to surmount the stone walls of its self-imposed mental barriers. In fact, it has not even tried. There has been no serious, sustained program to deliberately examine the loopholes in present theory and seek the necessary changes to provide a theory of paranormal-psychotronic phenomena. In fact, the major Western work on paranormal phenomena seems only to attempt to "prove" over and over that such phenomena exist; and to attempt to derive from present physics theory a "normal sane" theory for "abnormal insane" phenomena. The orthodox establishment continues to vigorously attack the experimenters who struggle with paranormal research on the grounds that their work does not present science. Hence the experiments and experimenters are unscientific and either at worst frauds and charlatans or at best seriously deluded.

The simple procedure necessary to solve these questions — set up a deliberate, well staffed, well-funded program on a continuing basis — has not been adopted in

the West because of the short-sightedness of our management structure. We seem to have totally forgotten that we got the atomic bomb in the first place and we put a man on the moon, simply by starting a program with staff and funds to try to do it, not by engaging in a neverending series of arguments as to why it could not and should not be done.

So, ironically, the nation that prides itself on being free and liberal has adopted an iron dogma of its own in science, a dogma that yields very slowly and that has effectively blocked us from serious and prolonged efforts in psychotronics.

Meanwhile, the Soviet scientists — admittedly kicked firmly in the tail by Stalin — have simply got off their dust-encrusted seats with alacrity and got to it. In thirty years of such getting to it with massive state support, they have already launched the psychotronic age, first applying it to the weapons field, the typical Soviet priority. Meanwhile, for the same thirty years we in the U.S. have played the same old tired games that once led Heisenberg to remark that new scientific knowledge only gained acceptance when the old scientists who so adamantly opposed it had died away.

Finally, there is a direct relationship between UFO's, psychotronics, the collective human unconscious, the Cold War, and Fer-de-Lance that cannot be escaped. So while this section emphasizes psychotronic weapons deployed by the Soviet Union I continually remind the reader of the concepts involved in the related paranormal phenomena, which were covered in Parts One and Two. So with these words, let me give a brief summary of Soviet psychotronic weapons. Make no mistake, it appears that the final holocaust is now unavoidable — we will reap the full rewards for our smugness, pride, arrogance, and inflated egotism.

The Soviets will unleash World War III and they will unleash the psychotronic weapons on a totally unsuspecting world.

But there is something more; it does not end there. There is another player in the game — the collective human unconscious, ZARG itself, will unleash a reaction that makes psychotronic weaponry pale by comparison. Yet when that great entity has roared out its anger, destroyed perhaps half the earth, and then opens its eyes, the full biblical prophecy will in a most bizarre and unsuspected way be fulfilled.

Time will end, and the grave will give up its dead. The unifying of all human minds into one will complete the birth of a new godlike being, extending from the beginning to the end of time all at once, and from beginning to end of all possible times all at once. Three-dimensional concepts and limitations will fade away as child's play to the being that is already in four billion dimensions.

And you and I will become gods, literally, actually — for being is holographic, and whatsoever ZARG becomes, so we all become.

## **PSYCHOTRONIC BACKGROUND SINCE WW II**

After WW II Soviet scientists were ordered by Stalin to actively seek another area of great breakthrough — such as the U.S. atomic bomb had been — and leave no stone unturned in their search. Apparently the Moray detector was resurrected and intense experiment and development begun on it. Much of the pioneering radionics work of the West and Ive's work would also have been available at this time. I believe that in 1958 the Soviet nuclear catastrophe near the Urals was the

result of an attempt to transmit a nuclear explosion through hyperspace. (The peculiarity of a transmitter tuning failure would have resulted in an explosion emerging from the nearest large nuclear waste storage, and that apparently happened.)

In 1956, however, a major new interpretation of quantum mechanics was originated by Hugh Everett at Princeton University under the world-renowned John Wheeler. This is the theory of the universal wave function—the many-worlds interpretation (MWI) of quantum mechanics. Practically the entire Western output on the subject is available in his 1973 book entitled *The Many-Worlds Interpretation of Quantum Mechanics*.

This physics is so exceedingly strange that it has been ignored by almost all Western physicists — indeed, it is so strange that even its originators, Everett and Wheeler, are said not to be able to believe it. Wheeler is reported to have once stated that he could believe it on Monday, Wednesday, and Friday, but not on the other days of the week. Using the MWI, however, one can produce a theoretical model of psychotronics which is totally consistent with the entire experimental basis of modern physics, and unite both mind and matter on a single scientific basis.

The Soviets apparently seized on this new theoretical work and applied it to the Moray device, solving their theoretical and technical difficulties.

In 1960, Khrushchev, speaking to the Presidium, stated that the USSR had a new weapon in development ("just within the portfolio of our scientists, so to speak") that was so powerful it could wipe out all life on earth. I believe he referred to the nuclear hyperspace howitzer and to the death ray weapons under development at that time, such as the following.

## **ELECTRON DISSOLUTION**

There are four levels of effects on biological systems that are irradiated by electron dissolution beams.

Interference with the electrical functioning of the nervous system is the dominant effect. Single channel subsystems are more sensitive to the effect.

Mild irradiation (or mild kindling of short duration) causes weakness, trembling, and an unreal, dreamy feeling (as when one gets a whiff of anesthesia). The victim is conscious, however, since consciousness is limitedly multichannel.

Moderate irradiation (or kindling of moderate duration) causes paralysis of the motor system, and a very unreal, floating feeling. The individual is barely conscious and is hypnagogic. Panic is usually engendered.

Strong irradiation (more protracted kindling) causes loss of consciousness in addition to paralysis. The autonomic nervous system still functions with difficulty, and the victim is just barely alive. Convulsions and other symptoms may appear.

Very strong irradiation (protracted kindling) totally jams all levels of the nervous system, and death results instantly.

In UFO contactee incidents this effect is widely demonstrated. Many cases show step function failure of automotive electrical systems, lights, radios, etc., as a UFO approaches. When the UFO departs, the electrical systems almost invariably resume complete operations. Absolutely no electrical components are damaged.

To extinguish these systems with massive RF fields would result in blowing fuses, diodes, transistors, etc., and a great amount of electrical sparking — probably sufficient to blow up the gasoline tanks. In fact, none of these things occur.

Stage 2 electron dissolution should definitely disable automotive circuits, and the upper level of stage 1 may be sufficient. Either would leave the automobile passengers conscious, though paralyzed in one case and not in the other. Both types of correlations are shown in the UFO literature.

## THE 1973 CONTACTEE WAVE AND CATTLE MUTILATIONS

In 1973 the Yom Kippur war took place. This was the Soviets' "Spanish Civil War," and they tested the final tactics and equipment for antitank and antiaircraft weaponry, and obtained final data on tank and equipment loss rates for modern combat. The effect on the U.S. and NATO of the cutoff of Arab oil was also tested.

At one point, when the Israelis cut off an Egyptian army in the desert, the Soviets notified the U.S. over the hot line that Soviet forces were going in and the U.S. could do whatever it pleased. The Soviets loaded and readied seven airborne divisions to insert, and the U.S. readied its single airborne division to send in. So the world teetered on the brink of direct ground confrontation between the Soviet Union and the U.S., with all its possible consequences.

Confrontation is after all another form of *contact*. And UFO contactee cases involve *confrontation*. In the very month, October, that the Yom Kippur War erupted, the greatest wave of UFO contactee cases in history broke out in the U.S. Further, in the shallower unconscious levels above the collective species unconscious, which were modulating and molding the tulpoidal reality format, the imagination of the world had been captured by the spacesuited astronauts who had walked on the moon. So most U.S. contactee cases involved spacesuited beings, conditioned into that framework by the national, cultural modulation. Some of the contactee cases involved robots or metallic men, similar to the mechanisms and robots of the U.S. space program. And here in the U.S., the fortress, the female-mandala craft symbol was generally maintained.

Now if this unbelievable scenario has any validity, then after the dress rehearsal of the 1973 Yom Kippur War we ought to have seen an increase in the tulpoid phenomena of a sharply symbolic nature. And that has happened.

The cow is the Western female symbol par excellence; Western children nurse on cow's milk, so to speak. If the U.S. fortress is to be violated, then the female symbol will be violated as the time for the Soviet assault nears. So cattle mutilations of a mysterious, paranormal nature have been occurring all across the U.S. — from the East Coast out through Colorado, Utah, and Montana — approximately nine thousand by now, in some estimates. The symbolism in the mutilations can be easily read: the U.S.'s lifeblood is going to be drained, totally, as all the blood is usually drained from the cattle. The Soviet operation will be launched with blinding speed and surgical precision, and the mutilation of the cattle is done as if by highly skilled surgeons. The children of the West shall be cut off from their sustenance, and so the cow's teats are removed. The armed forces (males) confronting the Soviet forces will be devastated (i.e., the fruit of the womb will be

Precursor(s)	Wave(s) / Incidents	Comment
German rockets in WWII/Soviet threat in 1946-47	1946-47 ghost rockets over Sweden and adjacent countries, from direction of U.S.S.R.	Phallic tulpa symbols
Buck Rogers/sci-fi ships Cold War 1947	1947—Flying saucers	Circle/Disc mandala in scientific dress
1950 Critical Korea period	1950 Wave of UFOs	Peak pressure surge on collective unconscious
1952 Critical Korea period	1952 Wave of UFOs	Peak pressure surge on collective unconscious
Sputnik 1957-1959	1957-1960 Wave of UFOs	Peak pressure surge on collective unconscious
Cuban missile crisis 1962	1962 Wave of UFOs	Peak pressure surge on collective unconscious
Arab/Israeli War 1967	1967 Wave of UFOs (4th largest)	Peak pressure surge on collective unconscious
Arab/Israeli War 1973 Near confrontation U.S. vs U.S.S.R.	Spectacular 1973 wave contactees increased, space-suited beings increased	Peak pressure surge on collective unconscious; astronauts had walked on moon.
Soviet attack preparations completed	1975-present cattle mutilations in U.S. heartland	Cow is female symbol. The female (fortress, sanctuary) will be violated.

Fig.31. Examples of UFO waves





October 11, 1973 UFO CE III  
The Pascagoula incident from the witnesses' viewpoint.  
Humanoids were atypical.

**Fig. 32. 1973 Contactee wave**

devastated) so the sexual organs of the cows are excised. Free speech and freedom to hear will be cut off, so the cow's lips, tongues, and ears are excised. A very high (psychotronic) technology will play a role, but one which will limit resistance, so the cut edges are often made as if by pinking shears and then precisely burned as if by a laser. (The laser is symbolic of new, strange technology almost incomprehensible to the average person.) In one case a horse was the victim — a young horse, symbolic of the young soldier. It was castrated, as the dominance of the Western soldier will be surgically excised. Castration of the male symbolizes the total loss of his power and the infliction of impotency upon him.

There is more, but this is a bloodcurdling sampling of the metapsychological implications of the cattle mutilations.

## **RADIATION OF THE U.S. EMBASSY**

About 1959 or 1960 the radiation of the U.S. Embassy in Moscow with weak microwave radiation began. It continues to this day. The radiation is a brilliantly designed intelligence probe: the Soviets were vitally interested in ascertaining whether or not their U.S. adversary knew about psychotronics (i.e., whether the U.S. had built such weapons of its own and might have built defense counterweapons as well). Accordingly, they began weak PT-modulated microwave radiation of a high-level U.S. target, the U.S. Ambassador to the Soviet Union, which would guarantee the personal attention of the State Department, NSA, CIA, DIA, the President, etc. The PT modulation apparently consisted of various disease patterns of gradually increasing seriousness — flu, blood changes, heart irregularity, cancer, etc. By the U.S.'s reaction, whether or not it knew anything of PT could be positively assessed. If the U.S. reacted only to ordinary electromagnetics, then with 100 percent certainty it knew nothing of PT and had no secret PT weapons of its own or counters to the Soviet PT weapons. So since about 1959 or 1960, by our slow reaction to the radiation of the U.S. Embassy — and then by our reaction only to the electromagnetic aspects — we have been assuring the Soviets that we know nothing of PT. Even though several U.S. presidents have protested the radiation, the Soviets have persisted because it is an intelligence tool of the utmost importance to them.

## **DISEASE AND DEATH TRANSMISSION**

For confirmation of Soviet experimentation with PT induction of death and disease, see V.P. Kaznacheyev et al, "Distant intercellular interactions in a system of two tissue cultures," *Psychoenergetic Systems*, Vol. 1, No. 3, March 1976, pp. 141-42; and by the same authors, "Apparent information transfer between two groups of cells," *Psychoenergetic Systems*, Vol. 1, No. 1, December 1974, p. 37. These articles give one a glimpse of the results of over 5,000 Soviet experiments on the basic effect. Kaznacheyev is the head of the Siberian Branch of the Soviet Academy of Medicine, and has at his disposal every disease germ, virus, and toxin known to man. Note that the experiments were performed in the dark to prevent the quenching effect of the visible light spectrum and the effect is only obtained

through the quartz (which has IR and UV windows). Also note that in the two-slit experiment — which contains all the mystery of quantum mechanics, according to Nobel prizewinner Richard Feynman, cofounder of quantum electrodynamics — one does not get the quantum effect with an electron, if the electron is first hit by a photon of light before reaching the two-slit region. If the electron is not hit by a photon, one gets the quantum effect. According to Feynman, the quantum effect in the two-slit experiment is not explainable by any classical means. Our comment is that the explanation is not possible by Aristotle's three laws of logic, on which all Western logic, physics, and mathematics are based. However, the fourth law of logic, together with the present three laws, provides a closed metalogic which does contain the explanation of the two-slit experiment, as we showed in Part Two. The fact that there is no problem in explaining the experiment if one takes into account the nested structure of time was pointed out as long ago as 1957 by Dr. Charles Muses. Similarly, the disease and death transmission experiments of Kaznacheyev et al have been explained in Part Two.

## **OTHER WEAPONS**

Clandestine testing of PT weapons also appears to have been accomplished directly in the U.S. The Legionnaires' disease may have been one such test. The suspect agent was actually seen, according to sworn testimony before a Congressional committee. A person with a book-sized object in his hand (tape recorder with PT pattern), a tobacco-pouch sized object in his coat breast pocket (transmitter) and a wire running to his tie clip (antenna) was present and mingled with the Legionnaires for several hours. He was heard to exclaim several times to various Legionnaires that it was too late and they were all doomed. The eventual appearance of the weird "biological agent" that is different from any other germ known can also be explained by kindling from the anxious minds of the baffled U.S. researchers and scientists. Other such tests have also apparently been conducted.

## **HYPERSPACE HOWITZER OPERATION**

The facility at Semipalatinsk is a third-generation hyperspace nuclear howitzer. It can transmit a full nuclear explosion through hyperspace into a tuner planted anywhere in the universe, without traveling through or in normal space at all. Furthermore, it has a unique characteristic: any number of receiver-tuners may be tuned to the transmission channel and each will have the full nuclear explosion emerge from it, undiminished.

Thus, one channel might be for U.S. Minuteman sites, and a tuner on that frequency (say one containing 100 transistors, sealed in plastic and buried in the earth) could be replanted near each Minuteman site. Another channel might be for all the SAC bases, another for large U.S. cities, another for nuclear weapon storage sites, etc. Any or all of these could be connected to a single blast transmission, simply by controlling the channel width over which the hyperspace transmission occurs.



Fig. 33. Cattle mutilations

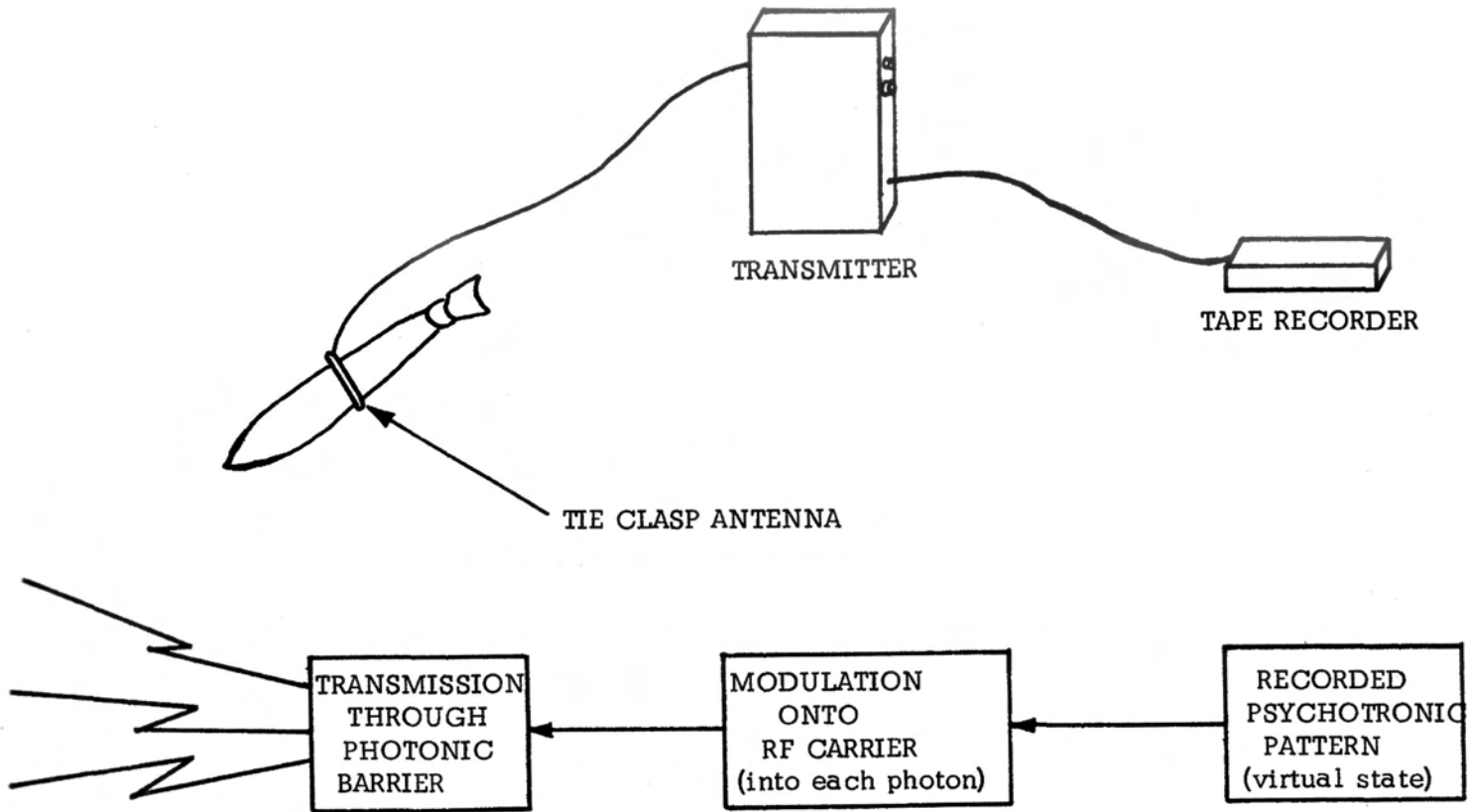

Fig. 34. Induction of Legionnaire's disease

Here one must not confuse ordinary single-channel conservation of energy with hyperspace operation. The transmitter corresponds to the grid of a gigantic triode, the preplanted receivers constitute the plate area, and zero-point vacuum energy constitutes the cathode energy source. So just as in a triode, energy is conserved from cathode to plate, but not exclusively from grid to plate. Since zero-point vacuum energy is being gated by the triode grid (the howitzer) signal (the explosion), the energy that can be outputted at the plate (from the tuner-receivers) is essentially unlimited. Any number of receiver-tuners can be connected to a channel, merely increasing the plate area. And from each tuner there can emerge a full-scale, undiluted replica of the explosion in the howitzer at Semipalatinsk.

Thus a single nuclear blast at Semipalatinsk can in one instant wipe out all hind-based strategic nuclear retaliation capability in the Free World, if the preplanted tuners are on site.

An additional modification — something like additional orthorotator rings surrounding the primary hyperspace orthorotator ring — may have been made to the nuclear hyperspace howitzer within the last two or three years. If so, this would have the characteristic of materially reducing the "spillage" fraction of the nuclear explosion and also the vibration associated with a firing. There is a possible indicator of this: quoting from *Science*, "On five occasions during the first half of 1976 traces of neptunium-239 and molybdenum-99 were detected in southern Sweden. These activities were accompanied by small amounts of fission products such as iodine-131 and barium-140. One of the events was coincident in time with large peaks in the atmospheric tritium gas concentration." (Lars-Erik DeGeer, Swedish National Defense Research Institute, "Airborne short-lived radionuclides of unknown origin in Sweden in 1976," *Science*, Vol. 198, No. 4320, 2 December 1977, pp. 925—27.) These events were concentrated during the time the Semipalatinsk experiments are reported to have started, yet no seismic activity was associated, as would have been the case if ordinary nuclear explosions had occurred in normal space inside a containment sphere for a large particle beam experiment. On the other hand, if a very high percentage of the explosion were transmitted/rotated into hyperspace, then residual traces of a nuclear explosion would have been present in the atmosphere because of the very slight spillage venting into normal **space**, but almost all mechanical shock and vibration would have been eliminated. It is at least a striking correlation that exactly such indicators are present, as reported by DeGeer.

A clever adversary who becomes aware of the necessity for preplanted tuners could use a very simple but completely effective countermeasure: simply locate the timers and dig them up, then clandestinely put them back into Soviet territory. Or **build** tuners of one's own and plant them in Soviet territory. Thus it would seem imperative to develop a mode of operation that does not require preplanted tuners at the target area.

This capability can be provided by using the howitzer in an interferometer mode — by constructing additional orthorotation rings around the firing chamber (but a "hyperspace interferometer" exists). With this scheme any point on earth can be precisely focused on by the howitzer, and no preplanted tuner is necessary. The advantage of this mode is the elimination of the need for clandestinely preplanted receivers, and the freedom to operate in spite of any receivers preplanted by the adversary on Soviet soil. The disadvantage of the interferometer is that the

former "triode" operation has now been converted to "diode" operation — when one explosion is put into hyperspace, now a single explosion at a single target area emerges, since a single selected spatial location is now exclusively determined by the interferometer settings.

For a more complicated interferometer mode, orientation and alignment of the interferometer's indicators and controls and amplifiers would be necessary. This could be done using fractional kiloton yield weapons — or even ordinary HE explosions — and focusing the howitzer at a displaced aiming point, at some distance from the target area. This is simply the standard artillery technique of registering a gun on an offset registration point, then performing an x-y shift to the intended target when the gun is fired.

Orientation and alignment of such a weapon system probably accounts for the sonic booms — mysterious high altitude explosions — off the East coast of the U.S. in December 1977 and January 1978. Over the West coast, mysterious explosions occurred inside thunderstorms; these also could well have been the adjusting of the weapon. By using about 100 tons of TNT explosive in the howitzer, a very good high burst registration could be made, and "forward observer" agents in the U.S. could observe the bursts through optical instruments and report their exact positions, thus calibrating the interferometer settings. Of course, mysterious booms have been around for quite a few centuries; however, these "normal but unusual" phenomena have quite a different sound than does the howitzer shot. The natural booms are not so much like single giant explosions as like rolling thunder. Furthermore, several observations of the booms off the U.S. East coast confirmed light flashes (which have not been seen to accompany the natural booms) and swirling or rotating effects in the flashes. Also UFO's were directly associated with some of the booms, revealing the stress factor on the collective human unconscious, implying their Soviet psychotronic origin. A few years ago similar high altitude booms occurred over Ohio and surrounding states, and such booms have also occurred off the coast of England.

Thus the howitzer may have been accurately aligned for diode operation, calibrated near the East coast, on the West coast, in the center of the U.S., and near England. Furthermore, its firing rate and recovery time were also apparently checked out; five booms occurred on one day and after a lapse of several days, the booms occurred again.

As I describe the fantastic psychotronic weapons the Soviets possess, the reader may wonder why the Soviets have not already attacked. The reason is that the superweapons have a strange weakness and failure mode possessed by no other kind of weapon. The hyperspace amplifiers in the psychotronic weapons depend on a large number of stages, say sixty to one hundred, and the hyperspatial flux in all these stages must be very stable and isotropic. At odd intervals the flux coming in from hyperspace suddenly becomes turbulent; this destroys the smooth coherence in the multiple stages of the amplifiers, and thus the basic amplification mode. Thus *all* the psychotronic weapons will suddenly cease working at the same time, and this "all fail" mode may last from fifteen minutes to even three weeks in an extreme case. Thus the weapons are erratic and not dependable. For this reason, the Soviets dare not rely *exclusively* on them, and so they have been forced also to prepare for full nuclear war as a distinct possibility when they launch operation Fer-de-Lance, the full attack. They have thus built up their regular army, their

navy, their strategic offense systems, and their strategic defense systems on a scale unparalleled in human history. Today the Soviet Union is the strongest nation on earth — by far — and is fully prepared to launch World War III and win it, with or without superweapons.

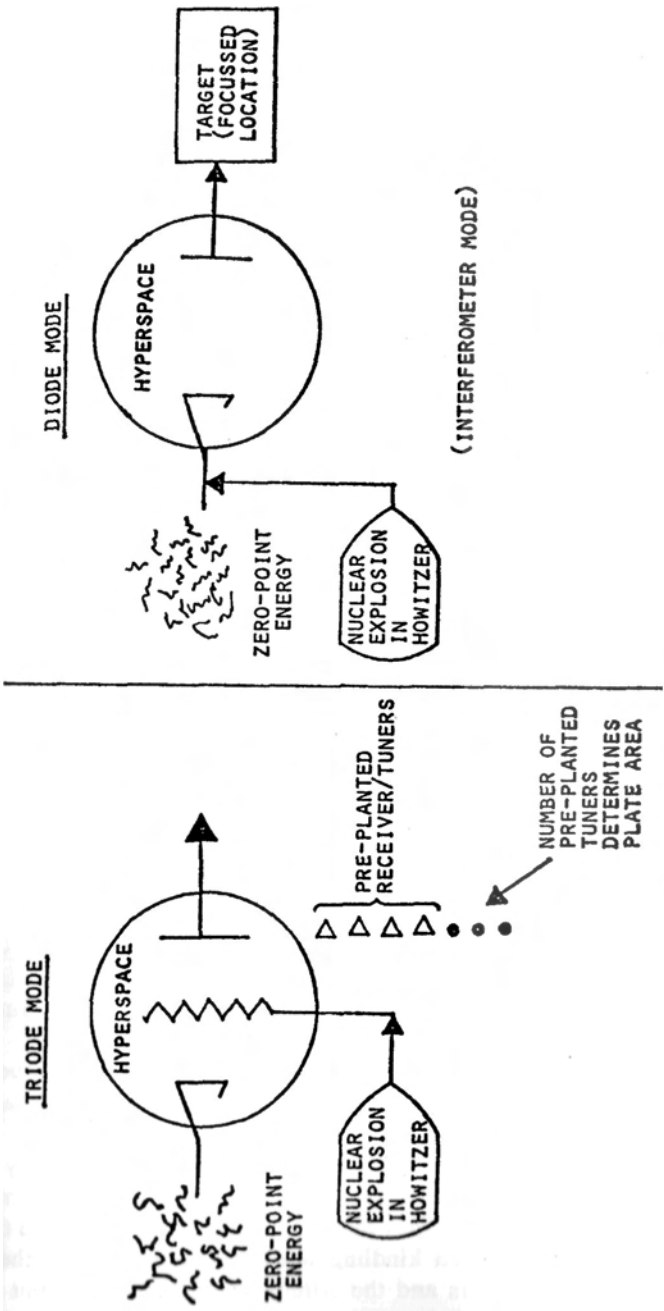

Fig.35. Hyperspace howitzer operation (2 figs)



## A POSSIBLE OPERATIONAL TEST OF PSYCHOTRONIC ANTI-AIRCRAFT WEAPONS

When the F-111 all-weather attack aircraft were deployed in Vietnam, a rather interesting loss rate pattern emerged. Of the forty-eight F-111's in operation, eight were lost at the beginning of the action, but no losses occurred thereafter, according to General Vogt, the officer responsible for U.S. air operations at the time.

Initially there were some radar anomalies and other system malfunctions with the aircraft, but these problems were quickly resolved. The F-111's flew singly, extremely low, and without radio contact. Between September 1972 and the end of hostilities in Vietnam, the F-111's flew over 4,000 sorties, never losing any planes other than the eight lost initially.

The reason for the loss of the eight planes remains a perplexing mystery. In fact, there is no knowledge of exactly where the planes were lost, except in one case. That F-111 was downed over Hanoi, and its two pilots, Captain Robert D. Sponeybarger and 1st Lieutenant William W. Wilson, were captured alive by the North Vietnamese. The two airmen were later returned under the prisoner of war exchange program, and they then told of the loss of the aircraft, which took place under very strange conditions.

According to the two crewmen, they met a sudden disaster while flying over Hanoi at night, supersonically, and at very low altitude — only a few hundred feet above the earth. Without warning the F-111's emergency indicators lit up like a Christmas tree, indicating massive and multiple failures of unrelated aircraft systems.

They were not hit by a surface-to-air missile, according to the crewmen, because no explosion of a missile warhead, with its concomitant fireball, occurred. If large-caliber automatic weapons fire had hit them, the distinctive streak of the tracers would have been clearly visible in the night sky, and a sharp impact in the aircraft structure would have been felt. None of this happened.

It could not have simply been an aircraft malfunction, because far too many unrelated aircraft systems failed at the same time. (There is triple redundancy in the control system of the F-111, by way of comparison.)

Indeed this initial loss of eight aircraft — and then no further losses at all — is difficult to explain rationally, as are the mysterious circumstances surrounding the loss of Wilson's and Sponeybarger's craft.

However, it requires no stretch of the imagination to realize that the Soviets very much desired to obtain the glittering new F-111 to examine its technical characteristics, its sophisticated design, and its highly sensitive terrain-following radar, ECM gear, and other avionics equipment.

Also, the Soviets had a pressing need to try out one or more of their psychotronic anti-aircraft weapon systems — perhaps one which simply modulates a radar beam psychotronically to induce electron dissolution.

Accordingly, it can be postulated that the pragmatic Soviets simply combined both needs, and quickly set up a psychotronic trap for the F-111's immediately after the aircraft were deployed. They may even have cleverly designed the specific psychotronic modulation so that kindling would occur in some of the aircraft's electrical systems before others and the failure would be massive but not total.

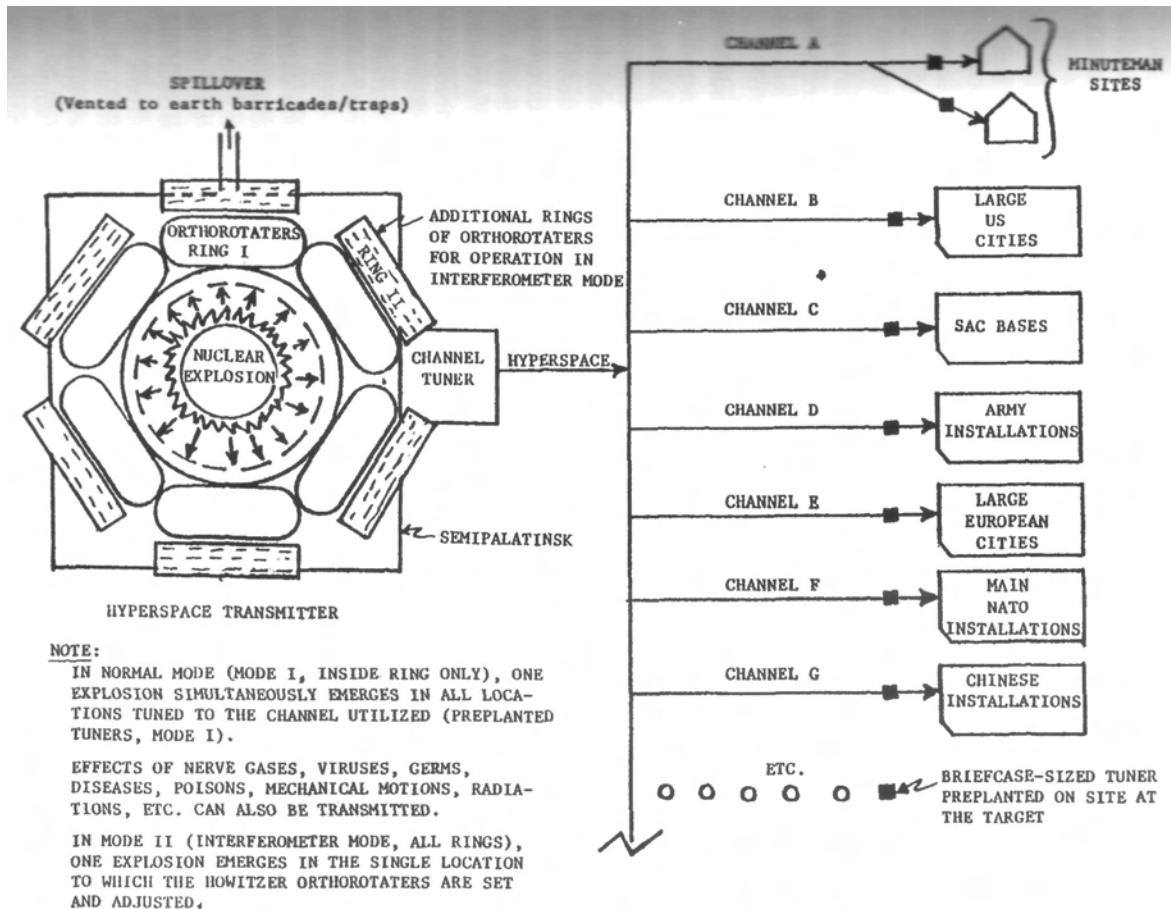

**Fig. 36. Nuclear hyperspatial howitzer**

And after they nailed enough F-111's for their purposes, they quietly withdrew the psychotronic modulator, to prevent the U.S. intelligence analysts from catching on to just how really strange the losses of the F-111's were.

Thereafter the remainder of the F-111's were successful, and no more were lost. Indeed the F-111 comes in so low and so fast, and so unexpectedly, tilting and dipping as it terrain-follows on its automatic equipment in a manner that no unassisted pilot could fly, that SAM's and guns normally pose little if any threat to it. So once the silent, eery psychotronic anti-aircraft components were withdrawn, the normal anti-aircraft weapons of the North Vietnamese were unable to down any more F-111's.

And we Americans simply patted ourselves on the back, chortling to ourselves how quickly we had "learned to avoid that danger, whatever it might have been."

## POPULATION CONDITIONER

Inducing psychotronic signals into mass populations or audiences can influence or control the behavior of large numbers of persons. As these words are being written, such a psychotronic test is apparently being conducted by the Soviets with Eugene, Oregon as a target; previous tests were conducted in Canada.

Psychotronic signals and the patterns they carry can be, and are, modulated upon electromagnetic carriers — in fact, that is one way they are transmitted through the human body and nervous system. When a television camera picks up the photon field impinging on it from a human body or other biosystem, weak psychotronic patterns are also picked up, since the paranormal time quenching mechanism (by visible light) is never quite 100 percent effective. These patterns are riding then as a special kind of modulation on the radiofrequency or electromagnetic carrier — however, they are not modulated the same way as are ordinary signals. Ordinary signals gate the number of photons per second (amplitude modulation), or change and control the frequency of the carrier photons (frequency modulation), or change and control the phasing (phase modulation). However, psychotronic modulation rides on each individual photon, on its time portion (a photon consists of action — energy x time — and it is the time portion on which the psychotronic modulation is riding.)

Thus psychotronic modulations can ride on the transmitted television carrier frequency. The psychotronic modulations are processed through the television receiver, and a small component is emitted as a weak modulation riding on the photon signals emitted from the television picture tube. Along with the light from the tube, these psychotronic modulations enter the eye of the human observer and are demodulated by the retinal interface, thus introducing weak psychotronic signals into the observer's central nervous system. Given sufficient repetition time (say two to four hours), the kindling effect can cause the human nervous system to be profoundly affected. Any disease or death pattern known to man (and some that are not known to him) can be transmitted and kindled in the target population audience.

In fact, depending on the sophistication of the coded psychotronic signals, it is probable that the modulation patterns can be targeted against a specific racial type, since there are certain genetic differences between races.

So the type of truck that roams the streets of a city, silently monitoring which television channel the viewers are watching, could be modified slightly to induce specific psychotronic disease or death vectors onto the television receivers. Or it could simply modulate the television transmitters. (A very obvious way is to modulate or pump psychotronically the ground of the electrical power supply, and in most cases this can directly pump the transmitters.)

Or the kindling signal can come from satellites, which radiate weak radio frequency signals downward toward the target population. Here economy of force can be applied; the same type of kindling that induces electron current quenching is usable as a satellite dudder or killer in an antisatellite role, or is usable as a paralysis and death beam weapon against target populations. It is also useful as a killer of other electromagnetic sensors by either jamming their circuitry or simply **wiping out** (quenching) their emissions which impact on the satellite, preventing any reflected signal.

By this effect, UFO tulpoids often prevent a radar from tracking them, **even** though the tulpoids are visually sighted.

There are literally thousands of applications; these are just a few to give an idea of the overall effect and its usefulness.

And the psychotronic signals can be modulated onto almost any kind of carrier — telephone, television, radio, the magnetic field of the earth, the Schuman resonance of the earth's magnetic field, the ordinary sixty hertz electrical power system, etc.

We might have an entirely different idea of the potency of the Russian trawlers if we appreciated what their use can be in the psychotronic mode.

We can also understand why a television broadcast of Uri Geller in the act of binding metal stimulated both the ability in other persons and the effect in other equipment across England. And also how the effect has been duplicated — at least so far as stimulating other persons to psychokinetic ability — in this country. A direct means of stimulating psychokinetic ability is thus suggested: simply place the subject to be developed or stimulated in a room with a number of television receivers, all tuned to the same visual program, and place the stimulus material on the receivers. The person should visually watch one receiver and should be wearing very abbreviated clothing, such as a skimpy swim suit, to expose the acupuncture plexuses. Also, normal light in the room should be very dim.

At any rate, this and many other schemes are available to produce direct stimulation, and enhance and greatly speed up psychic development.

The effect could also be used to produce an effective treatment device for cancer. Samples of the particular cancer in the body of the patient could be taken, and the invisible psychotronic radiation pattern from the cancer witness could be introduced on the input of a Hieronymus-type device, shielded against ordinary light. The output of the Hieronymus device could then be fed to a bank of phase inverters, which covered in total a broad band (the cancer band, which would have to be established by laboratory experiment). By inverting the cancer pattern, we now have a cancer-extinguishing type of radiation that is specific for the cancer the patient in fact has.

Then by introducing this quenching pattern as a modulation onto the correct tup of electromagnetic frequencies (again this group would have to be determined for the specific frequency plexus that would produce an effect in the local-

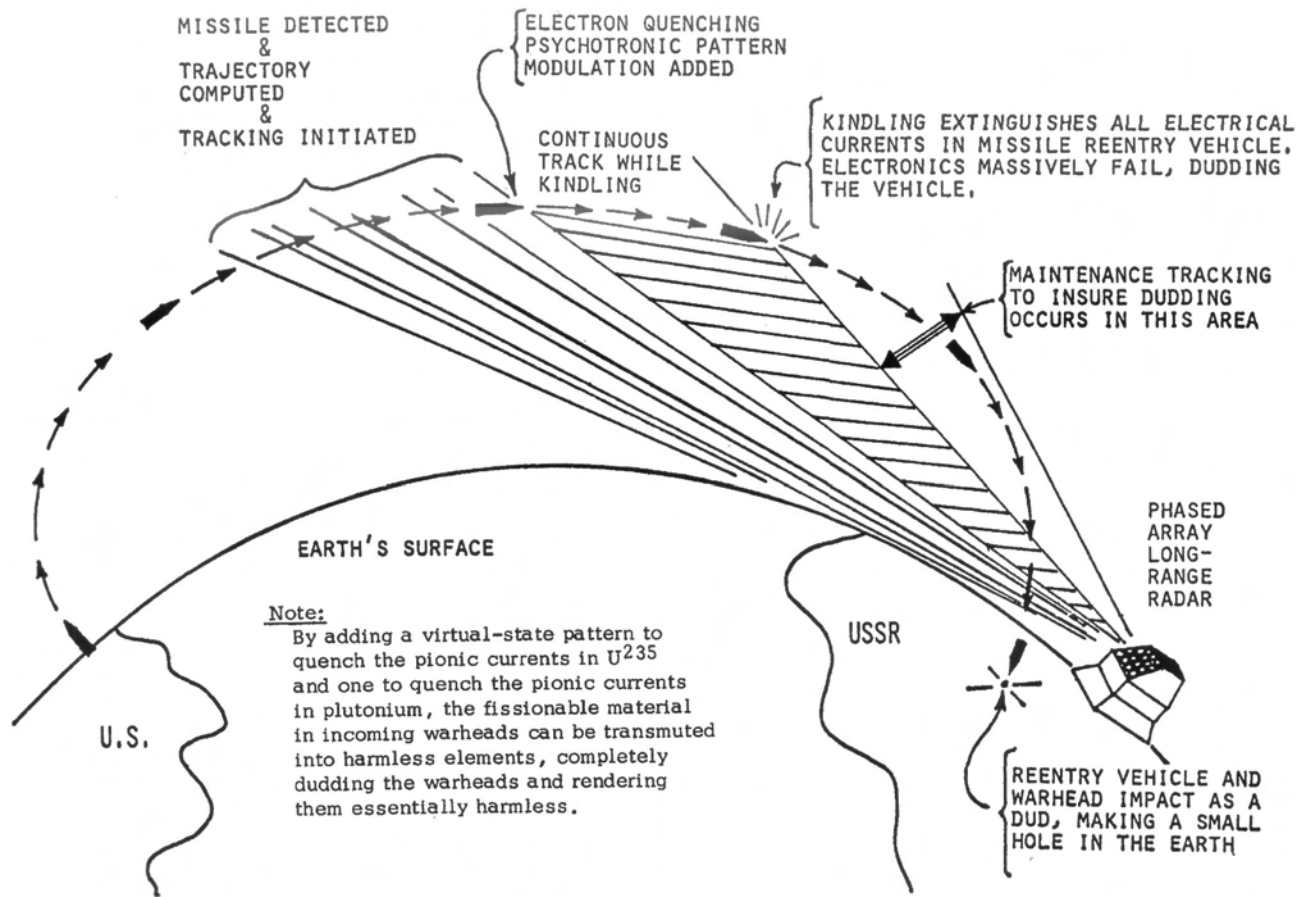

Fig. 37. A midcourse ABM system

ity of the body in which the cancer is located), the proper acupuncture plexus would be stimulated, stripping off the cancer-quench psychotronic pattern and sending it to the specific location of the cancer. Over a period of time (say several very weak microwave radiation periods of two to four hours each), the cancer could be killed completely, down to the last malignant cell. Whole body or spread cancers could be treated simply by increasing the number of frequencies modulated, to hundreds in some cases. Other similar diseases could be treated likewise. As an example, a Curative psychotronic radiation pattern complex could be worked for hydrophobia and such presently incurable diseases, and these could also be effectively treated. The same tool will yield almost unbelievable medical benefits if the scientists can ever be convinced to start the development.

## A MIDCOURSE ABM SYSTEM

Here is the scheme for a first-generation, long-range, Soviet midcourse anti-ballistic missile defense system.

A long-range radar — preferably a phased array, scanned radar — acquired and tracks the missile during its midcourse phase shortly after it breaks above the horizon, as viewed from the radar site. The radar programs the track mode beams against the incoming missile, tracking it and gathering sufficient position data to allow its trajectory to be computed. Then a psychotronic electron-extinguishing pattern is added to the radar beam, riding as virtual state carried by each individual photon. Kindling of this virtual pattern energy begins on and in the target vehicle. The electrons flowing in the electromagnetic control system, fusing system, and warhead system of the incoming missile begin to be quenched, turning into neutrinos and radiating away with no physical effect. When sufficient currents have been extinguished, the electromagnetic circuits start failing. (With loss of appreciable power and voltage, most such systems fail.) The incoming vehicle/warhead is now dudged, and there is no longer any danger of a nuclear burst from the missile.

For assurance, tracking of the incoming reentry vehicle continues, with a quenching psychotronic modulation being maintained.

The warhead/reentry vehicle strikes the ground, making a hole in the earth, without nuclear explosion. A low order detonation of the HE explosive surrounding the nuclear material in the warhead may occur.

An alternate scheme is, during the maintenance period, to add an HE explosives ignition temperature psychotronic pattern to the beam. In that case, a low order detonation occurs high in the atmosphere or back along the trajectory, removing the warhead and vehicle from further consideration.

As a backup, additional terminal systems — using either psychotronics or normal interceptor missiles or both — may be used. Thus even if the psychotronics fail due to an unexpected "all off" occurrence, ordinary ABM engagement occurs.

An additional scheme is to lock the radar beam onto the missile, then initiate a "Tesla effect" kindling of energy, place it into a columnar traveling wave, and direct it along the radar beam to the incoming missile in its midcourse phase. The midcourse missile is thus struck with a massive plasmoid fireball of intense electromagnetic energy, and massive amounts of energy arc dumped into the missile, destroying it.

Thus the Soviets have known for over a decade that one does not have to hit a bullet with a bullet, if one is clever, and if one possesses psychotronic weapons and psychotronic modulation systems for one's radars.

As an added benefit, the same radar is quite effective against incoming Strategic Air Command bombers or air-to-surface missiles fired from those bombers.

As the Soviets know full well, 100 percent defense is quite feasible, considering the fantastic number of radars and radar sites they possess! In fact many of the Soviet SAM systems are beautiful ABM systems also, in the psychotronic mode.

## THE BELL ISLAND INCIDENT

On April 2, 1978, something unusual hit the Canadian community of Bell Island, off the east coast of Newfoundland; Bell Islanders—and a lot of other people as well—are still trying to figure out what it was. It was first described as an unidentified atmospheric explosion, but this theory was quickly rejected. Jim Beckford of Lance Cove, Bell Island, lost all six chickens in the coop behind the house, which was torn up as if hit by lightning, although there were no burn marks anywhere. A television set exploded, and switches blew out of the wall. Similar things happened to many other homes.

In the woods behind Mr. Beckford's house, three holes in the snow appeared, spaced about two meters apart to form an almost perfect equilateral triangle. The Royal Canadian Mounted Police said that persons on the shore of Conception Bay reported seeing fireballs coming down out of the sky and hitting Bell Island. The Canadian authorities attempted to play down the incident, and the official version of what happened is that lightning hit a transformer, blew up, and that the energy then followed the wires to neighboring houses. However, the researches of P.A.C.E. (the Planetary Association for Clean Energy, Ottawa) have produced a different conclusion.

P.A.C.E. believes that a standing columnar wave originating in Gomel in the Soviet Union was moving to a station located just east of Havana, Cuba, and collapsed over Bell Island, triggered by the large iron ore body there. These plasmas then exploded and hit the ground in a perfect equilateral triangle formation. The tremendous flashes indicated a very great discharge of electrical power, probably more than a hundred million volts.

Photo 44 shows a similar incident that took place at Lake Ontario; here I feel that the photo demonstrates more than just UFO activity — it shows one part of the testing and operational alignment of the "over-the-horizon" radars at Gomel and Riga in a Tesla mode. To explain this, I must explain what I mean by a Tesla mode.

Empty vacuum is filled with stupendous amounts of uncorrelated electromagnetic energy: one cubic centimeter contains enough energy to form entire solar systems, if the energy were condensed into matter. This raw energy is called "zero point energy," and the Soviets reported direct measurement of it in 1957 (*Soviet Physics*, JETP 3, 819). Zero-point energy is everywhere, it is incoherent, and its detection requires measuring an energy difference, so that it is very difficult to detect. Usually less than one quantum of energy is cohered at any one mode, and the energy rapidly changes frequency, so that linear detectors cannot resonate

coherently with it to follow its signal. In my opinion, it is also in the virtual state, and in a space orthogonal to our own, by two or three turns.

An electromagnetic signal is transmitted through the earth and reflected from the opposite side in phase, to form a standing wave. The earth's interior is highly nonlinear, and a single frequency is thus subject to severe scattering and dissipation. Fortunately, nonlinear wave theory provides a simple method to alleviate this; by transmitting two different frequencies, which differ by the amount of the frequency that it is desired to transmit, one can simply pretend that *indeed the beat difference frequency has been transmitted through a linear medium*. In this case, the standing wave acts as a collector to kindle the highly chaotic energy from the core of the earth. These emerging orders that match the standing wave will be entrained by it; one now has established a sort of giant triode, where the signal to the grid is the transmitted difference signal, the energy (cathode) being gated is the energy of the molten core of the earth multiplied by some coupling fractional constant, and the "plate" will come into being if resistance to the standing wave is proffered.

And resistance is proffered by simply changing the frequency of the transmitted collector wave. Changing it in one fashion begins to dump energy into the atmosphere above the former nodal point across the earth from the transmitter. With that effect, one can directly influence the great currents of air and the ionization charge of the upper atmosphere; in short, one can drastically influence the weather itself. On the other hand, changing the frequency in the other direction begins to dump energy into the mantle of the earth; dumping large amounts of energy there will result in shocks and earthquakes at the nearest fault zone(s).

It is my thesis that the foregoing two mechanisms account for some of the drastic weather effects that have occurred in the past several years, as well as for *some* of the major earthquakes that have occurred throughout the earth in the last several years. The Soviets, I believe, have been orienting and aligning—and operationally testing—actual weapon systems to be used as precursors to war or during war. The 1978 Iranian earthquake may well have been Soviet-induced.

The coupled kindling path goes through the earth and is coupled through the atmosphere as well. (This mode is probably easier to steer and focus onto specific target areas. It is also probably easier to play it back and forth as desired, in a "sweep" mode.) Again, with the kindling effect, the energy of the molten core of the earth is coupled into the beam with a coupling fractional constant, and so enormous energy can be built up in the beam. Breaking the coupling — perhaps just afterslightly changing the frequency so as to begin dumping energy into the upper atmosphere over the targeted area — would sharply dump energy at the site, resulting in an enormous plasmic explosion or explosions. In testing such as at Bell Island, probably frequencies would be used that did not offer too strong a coupling fraction, so that relatively little damage would occur at the decoupled target site. However, in actual use in warfare, exactly the opposite would occur; a frequency would be used that maximized the coupling constant and hence vastly increased the energy kindled into and over the target area, and a gigantic plasmoidal explosion would take place directly on the targeted area, utterly devastating it.

The same "radar," then, is usable as a weather control device, as a plasma explosion transmitter, as a bioactive disrupter (with 10 Hz and under modulation pulses), and if further modulated in a virtual state manner, as a direct "death ray"



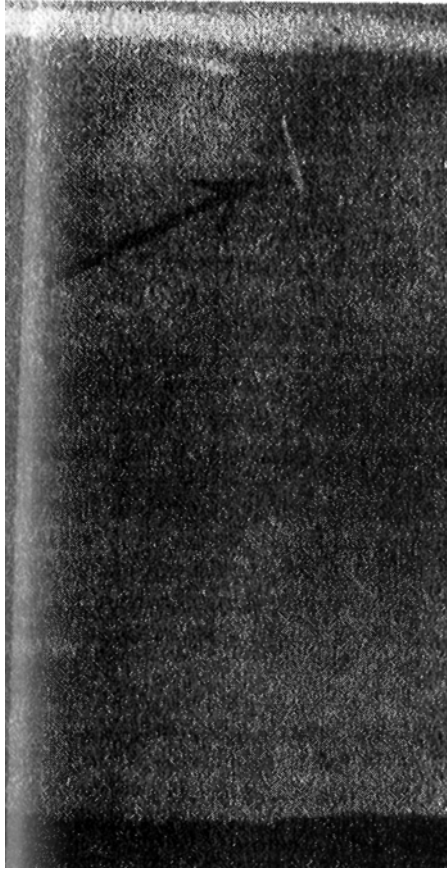

Photo 42. Ghost rockets.

broadcaster through the earth at any target population on the earth. Further, with virtual state modulation it is usable as an antimissile weapon (in at least two modes, one to dud electromagnetic circuits in incoming warhead reentry system and one to transmute fissionable material in incoming nuclear warheads into harmless elements), and also as an anti-aircraft weapon against Strategic Air Command Bombers,

So the Bell Island incident happened, and we in North America sleep on, since in our assurance that it was after all only all lightning, or perhaps only the illusion of a few farout Canadians.

## A TERMINAL ABM SYSTEM

There is another more advanced psychotronic ABM/SAM system, which was probably a second generation weapon. This system should have gone on site and become operational about 1968—69, and it should have been operationally tested during that period, probably several times.

Here a triad configuration radar is used to allow use as a hyperspatial interferometer. This allows several localized dome-like bands of very intense psychotronic energy to be focused above the installation and defended area. The focusing is accomplished through hyperspace; the only place the focused energy enters our own space frame is in the dome-like band above the protected area. Tesla-effect accumulators may feed the triads, or they may simply be fed from direct free-energy Moray generator-amplifiers. At any rate, enormous energy — enough to simply constitute a severe tearing and warpage of space itself, and bend it at  $90^\circ$  — is focused into each dome-like band. Each band would be seen externally as simply an intense band or hemisphere of glowing light.

At any rate, by using three consecutively tuned orthorotational bands of focused hyperspace energy, any incoming object will simply be orthorotated successively three times in higher dimensional space, each time losing one dimension in its intersection with our own spatial frame.

After the first orthorotation, masses are now photonic shapes, and photons are lines. After the second, photons are now lines and lines are points. After the third orthorotation, everything is points, and nothing is left.

The three consecutively constitute full dematerialization of anything incoming, whether matter, photon, or force line.

Thus the entire defense problem is immediately solved: regardless of chaff, maneuvering decoys, maneuvering re-entry vehicles, etc., the entire mess is simply nicely and neatly disposed of, and dumped into hyperspace.

Even if a full nuclear detonation occurs above the domed shields, gamma rays, neutrons, debris, x-rays, heat, and ultraviolet do not get through the third band.

Bombers and air-to-surface missiles fail equally.

So the growing Soviet confidence and preparations for imminent war are quite comprehensible. They are not madmen preparing to evoke their own doom from mutually assured destruction rained on them by U.S. strategic nuclear forces; instead, they are snug and safe behind their psychotronic defenses, for nothing we have on this earth can touch them at the present time, if their psychotronic weapons are working.

So they are quite capable of taking on China, Europe, and the U.S. at once, and devastating the lot while risking essentially nothing of Mother Russia.

## **SWEEP MODE, SWEEPING AWAY A NUCLEAR DETONATION**

As a modification of the previous weapon, a sweep mode has probably been added in the third generation weaponry.

In this mode, not only can the three orthorotation shields or domes be placed over an area, but they can then be expanded radially out into space in a traveling mode. Thus if a high altitude nuclear explosion — either in the atmosphere or out of it — has occurred over a defended area, the orthorotation bands can simply be swept over the explosive debris in successive fashion, effectively sweeping the radioactive debris from this spatial frame and dumping it safely into hyperspace. This is a very handy weapon indeed if large megatonnage explosions are engendered — say in areas where terminal defenses have destroyed the incoming vehicle, but it is "dead man fuzed" to provide a full nuclear explosion if the electronics start to fail or if the warheaded re-entry vehicle encounters mechanical shock or turbulence above a certain threshold. With this psychotronic sweeper the otherwise deadly nuclear radiation and radioactive debris can simply be cleaned up and disposed of.

Further modifications of other psychotronic weaponry would have resulted in Tesla-effect traveling wave weapons of enormous power, and rather gentle operational weapons testing of them, such as in the Bell Island incident and over Eugene, Oregon. The interferometer mode would have been added to the nuclear hyper-space howitzer, and Tesla-radars would have been modified accordingly.

These third generation weapons and modifications should have been deployed during the period 1974-78. Engineering development tests would have occurred during 1974—76, and operational testing of on-site, deployed weapons would have been accomplished during 1977—78.

Thus one can reasonably account for a surge in grain elevator explosions, mysterious high atmospheric booms off the East coast of the U.S. and off England, explosions in thunderstorms over the West coast of the U.S., the zapping of a Canadian target outside Ottawa, the Bell Island incident, several mysterious aircraft failures over the sagebrush triangle and off the coast of the U.S., standing heat spots off the West coast of the U.S., and recently one of the coldest winters on record due to disruption of flow patterns of frigid arctic air masses.

One can also account for incidents where U.S. satellites were mysteriously blinded, and perhaps some of those where they failed and then later resumed operations.

Note that many of these effects are usable from smaller radars. Thus one could expect mobile Soviet radars that can disable tanks and vehicles, disable aircraft electrically, radiate a death ray pattern at ground troops, or launch Moray-fed fireballs or standing waves of enormous energy at ground or aerial targets. The ability to immediately destroy entire minefields alone would force a severe recalculation of defense capabilities against Soviet ground forces, and the ability to sweep away artillery shells, rockets, missiles, and bullets would present enormous and catastrophic consequences to forces opposing advancing Soviet formations.

The following list enumerates all the probable Soviet psychotronic weapons that I am aware of: (1) Electromagnetic Field Canceled; (2) Electron Current Canceled; (3) Death Radiator (De-inceptor); (4) Free Energy Generator; (5) Psychotronic Bomb; (6) Brain Link; (7) Brain Probe; (8) Disease Radiator Ray; (9)

Emotion Radiator Ray; (10) Antisubmarine Systems; (11) Telcporters (Prototype); (12) Force Generators; (13) Orthoframe Generators; (14) Quark/Antiquark Rays; (15) Distant Telepathy; (16) Nuclear Radiation Inhibitors; (17) Mental Implantation; (18) ABM Systems, Midcourse and Terminal; (19) Dematerializer Shields; (20) Sweeps for Nuclear Debris; (21) AAA Systems; (22) Antisatellite Systems; (23) Tesla-effect Weapons; (24) Earthquake Generators; (25) Anti-vehicle Systems; (26) Weather Control Systems.

The reader will note that the results of psychotronic research extend into every field of military application.

## ZARG, ARMAGEDDON, AND LINKAGE

Now it is time to end my story, and cease the unrelenting stretching of the reader's imagination and credulity. But first it is necessary to make one more effort and take a final step to the bottom line in both physics and Jungian psychology, a step that the scientists in those two disciplines have not dared to face.

If one accepts the existence of the collective unconscious as a mind, then the collective unconscious is a living entity. Let us tentatively call this fantastic entity ZARG. ZARG then is a great superentity, of which our own personal consciousnesses and unconsciousnesses are parts, or cells. Thus each of us is a cell in the entity ZARG.

Furthermore, ZARG has unique characteristics. It is unconscious by definition — but note that from our fourth law of logic, we know that any zero-conscious must be multiply conscious, which to our monocular thought-perception processes can only be grasped as unconscious. That is why our own unconscious seems so bewildering and strange — it is multiply conscious rather than monocularly conscious, hence monocularly we think it is not conscious. But we find that it indeed thinks and reasons, but in a strange symbolic fashion, and also much more deeply and more creatively than our normal conscious mind. ZARG is very similar except on a much vaster scale; in being very deeply unconscious, ZARG is supremely multiconscious and very symbolic indeed, as we have discovered from the nature of the materialized tulpoidal phenomena.

Furthermore, what can be taken for ZARG's conscious mind consists of the four-billion individual human conscious minds. Thus ZARG's conscious mind is fragmented into four billion pieces. But fragmentation of the conscious mind technically constitutes dissociation, which classically defines psychosis.

Thus ZARG is insane!

Also, ZARG is multidimensional. ZARG's unconscious simultaneously receives and identifies four billion different conscious and unconscious perceptions. Just as the human consciousness in identifying two slightly different two-dimensional visual patterns gains the third dimension, ZARG gains an additional dimension for every additional person past the first one. (Note that dimension just means variable, and two fixed axes/dimensions are required to obtain a variable. A one-dimensional variable does not exist; we usually assume a time dimension in addition, and ignore it — and thus we speak of a "one dimensional variable.") At any rate, ZARG gains an additional dimension for every additional person past the first one. So ZARG is at least about  $4 \times 10^9$ -dimensional in the simplest case, where we do not consider permutations and combinations of every two, three, four, ... n, ... minds.

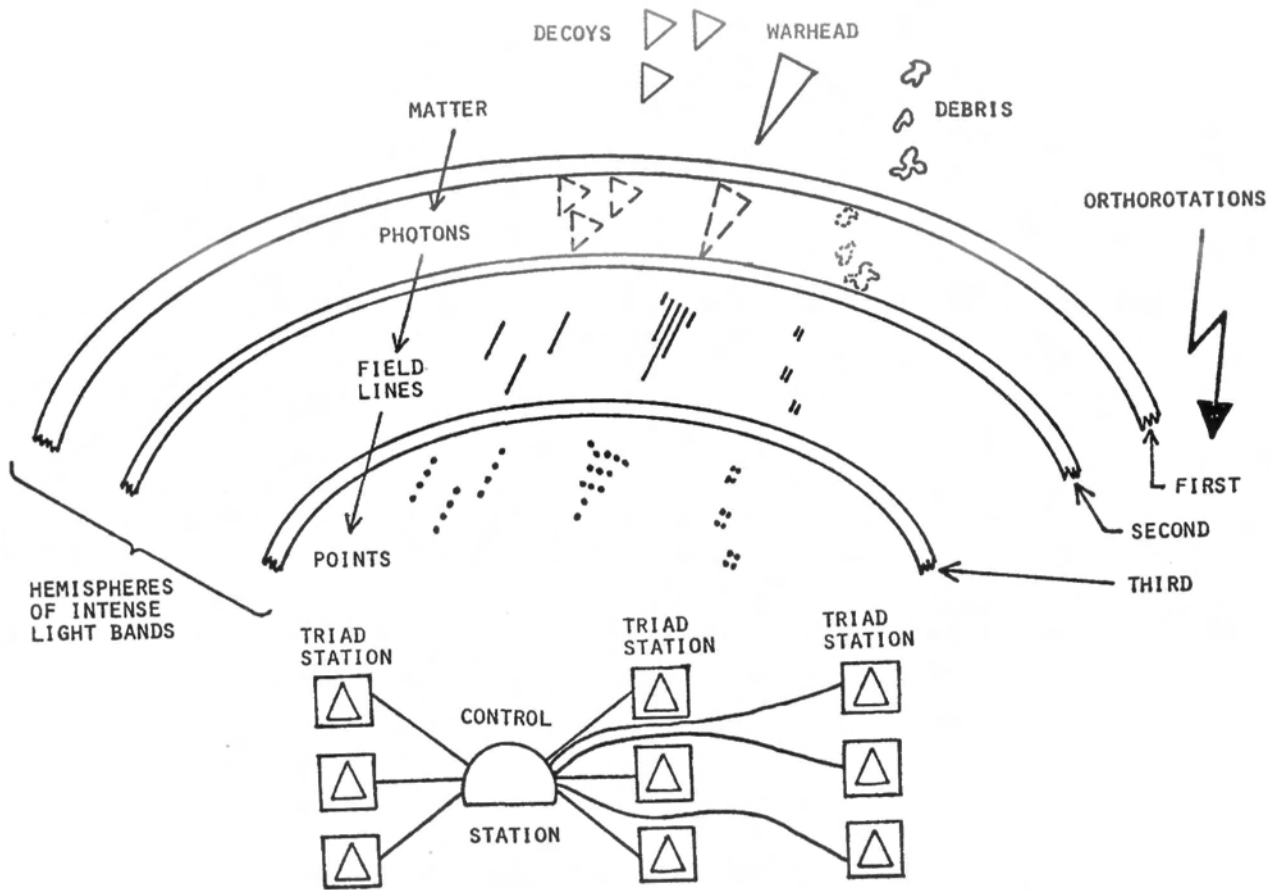
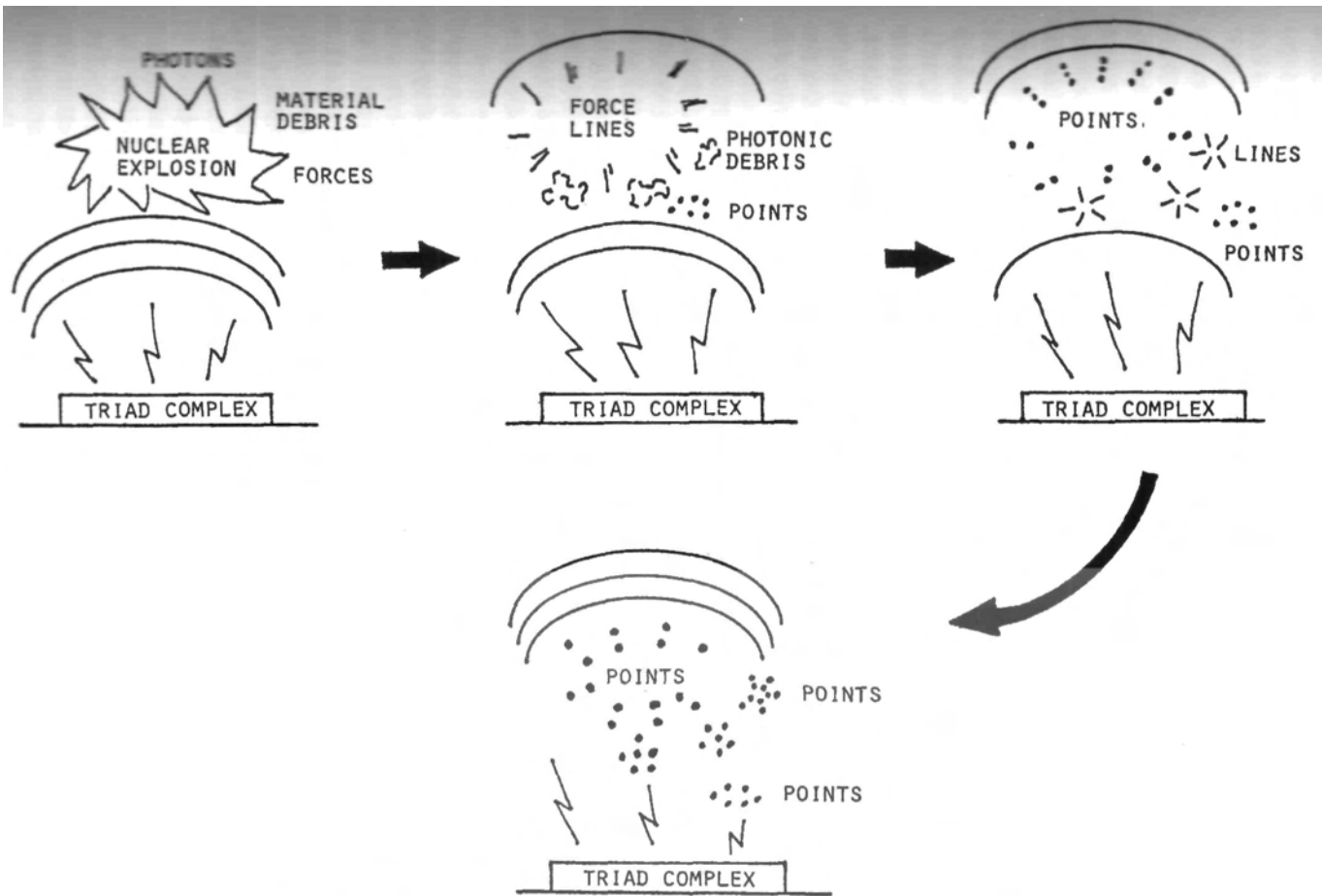

Fig. 38. A terminal ABM system



**Fig. 39. Sweep Mode: sweeping away a nuclear detonation**

Finally, it is well-known in parapsychology that the personal unconscious can affect matter and change spacetime itself. Psychokinesis, poltergeist phenomena, etc. are direct examples. Hyperchannel calculations show that, for linked multiple minds, this psychokinetic effect increases exponentially with the number of stages or minds that are cohered. Since ZARG has  $4 \times 10^9$  linked stages, this means that its psychokinetic/materialization/dematerialization powers are at least some  $10^{10^9}$  times as great as those of, say, Uri Geller. Thus ZARG can pull the very stars out of orbit, disrupt the earth or solar system, stop the earth in its orbit, or change the fundamental laws of nature itself. The reality we live in is largely prescribed by ZARG, and substantial tuning of many minds can directly affect ZARG's tuning and hence alter reality. It is not accidental that Brian Josephson, Nobel prizewinner in physics, once remarked that it appeared that in their diligent searches for strange new particles in their accelerators and cyclotrons, the physicists might be creating their own reality. In fact an accelerator or cyclotron is a kindling device par excellence, and a scientific theory by its very rigor is an exceptionally sharp mental concept or thought form. So if groups of physicists have worked diligently on a problem and predicted some new theoretical particle, they may well be able to kindle it into being if they persist long enough with their kindling mechanisms, because they are cranking up additional ZARG energy when they persist. While he knew nothing of the kindling mechanism, Josephson noted that many of the new particles were first obtained only after great difficulty, then with moderate difficulty, and thereafter they could be fairly readily obtained.

And as we have seen, ordinary physical matter occupies a universe or frame common to all minds of living biological systems. Thus the physical universe is quite literally simply thought that is common to all living minds, hence to ALLMIND or God or whatever other term one prefers to use. It is the fact that it is prescribed and represcribed, over and over, that lends a physical entity its seeming solidity as compared to the phenomena existing in only a single consciousness mindworld. This physical universe is mind, it is totally mind, and as such it can indeed be changed by the proper mind resonance in enough minds, or in powerful minds such as ZARG.

ZARG contains so many mindworlds or dimensions that it forms a very powerful part of the particular reality prescription of the physical laws exhibited by this physical universe. So materializations of tulpoidal forms, UFO's, bigfoot, and Nessies, are just a tip of the iceberg of what ZARG actually materializes. The tulpoidal forms are tiny surface ripples due to large-scale human conflicts.

And as we have also found, psychotronic energy is in fact pure mindstuff. Pure mindflux between mindworlds. And this brings us to another bottom line.

When the Soviets launch their long-prepared attack in Europe, wipe out China, and almost annihilate NATO forces (fifty percent casualties in three to four days), the U.S. President will undoubtedly be under extreme pressure to launch a strategic nuclear retaliation on the Soviet Union. Suddenly, in a single blinding display of almost unbelievable power, the Soviets apparently intend to destroy the U.S. triad weapons in a fantastic psychotronic blitzkrieg through hyperspace. The Minuteman sites, the SAC bases, communications centers, and other strategic targets will lie in smoking, devastated ruins in minutes, and within the same short minutes of that holocaust, the U.S. nuclear submarines on station under the ocean will begin rupturing like popping balloons. At the same time, massive swaths of

death will invisibly rain from the Soviet satellites in the skies overhead, and giant earthquakes will erupt into being in the East, in the West, and in the heartland U.S. The British and French nuclear forces will suffer similar simultaneous obliteration. And the jubilant Soviet Generals and Party theoreticians will be dancing with uncontrolled glee as their dreams become realities. But what they will not know is that their own inevitable doom will have just been sealed.

For all these fantastic psychotronic explosions will constitute gigantic psychotronic "mental flashbulbs" that explode directly in the mind of the sleeping ZARG. ZARG will be kicked into startled semiwakefulness, stinging with pain as if from a giant bee-sting, figuratively gnashing his teeth and furiously lashing his tail. This will constitute an immediate and enormous upheaval in spacetime itself, and the bulk of the earth may well be destroyed in the vast psychokinetic upheaval unleashed by the startled ZARG. Just as a person may sharply slap the bee on his arm where it has stung him, ZARG's fury will be centered on the Eurasian continent, on the locus where the threat or sting has originated, on Russia and the Warsaw Pact nations. So in an unbelievable convulsion of the entire earth, the Eurasian continent will be rent and torn asunder by forces beyond man's comprehension. The lousing ZARG will also activate a totally new scale of reality, ripping to shreds this particular three-dimensional spatial frame, its associated stable time changes, and the physical laws based on that stable reality.

The rousing of ZARG will initiate and accomplish the direct linkage of the conscious minds of humans into a single giant superconscious mind — extending into billions of dimensions. Spacetime and reality will have gone insane during the developing paroxysm; with the simple initial extension into just the fourth and fifth dimensions, humanity will suddenly discover that its entire world history from beginning to end will come into simultaneous being (fourth dimensionality), and **then** all possible such world histories will come into being (fifth dimensionality). Literally, dumbstruck humans will pray for death and not find it, the grave will "give up its dead," and the ceaseless flow of time will suddenly cease. And again the "beast will be defeated and cast into darkness"; with all-linkage and all-unity, there will be no longer be any humanity of one person for another or of one group for another, for there will be no other. In such manner, evil will end; there being no separation between the doer and the done to. Man will have become a true God — in a strange and bizarre way constituting the second coming of God.

So the Soviets are on a course to evoke the full carnage of something very like the Book of Revelation. John, looking across two thousand years of history into the future, and seeing the awful cataclysm that was to come, described it as best he could in the concepts available to his day and in the belief structure in which he functioned. Thus he described Armageddon and the end of time, and wrote the **Book** of Revelation.

Indeed it could have been accomplished without Armageddon, if humans had been wiser. Each photon and each electrical signal that wends its way across the earth's surface and through planetary space carries a psychotronic modulation of ZARG's mindstuff. And in the communications explosion we have experienced, we have been steadily lacing together the population centers of the earth with electrical energy and electromagnetic signals. And so over those crude "pre-nerves," the psychotronic connections of ZARG have been intensifying, and the Giant has slowly been being stirred from his sleep. The kundalini of the entire human race has



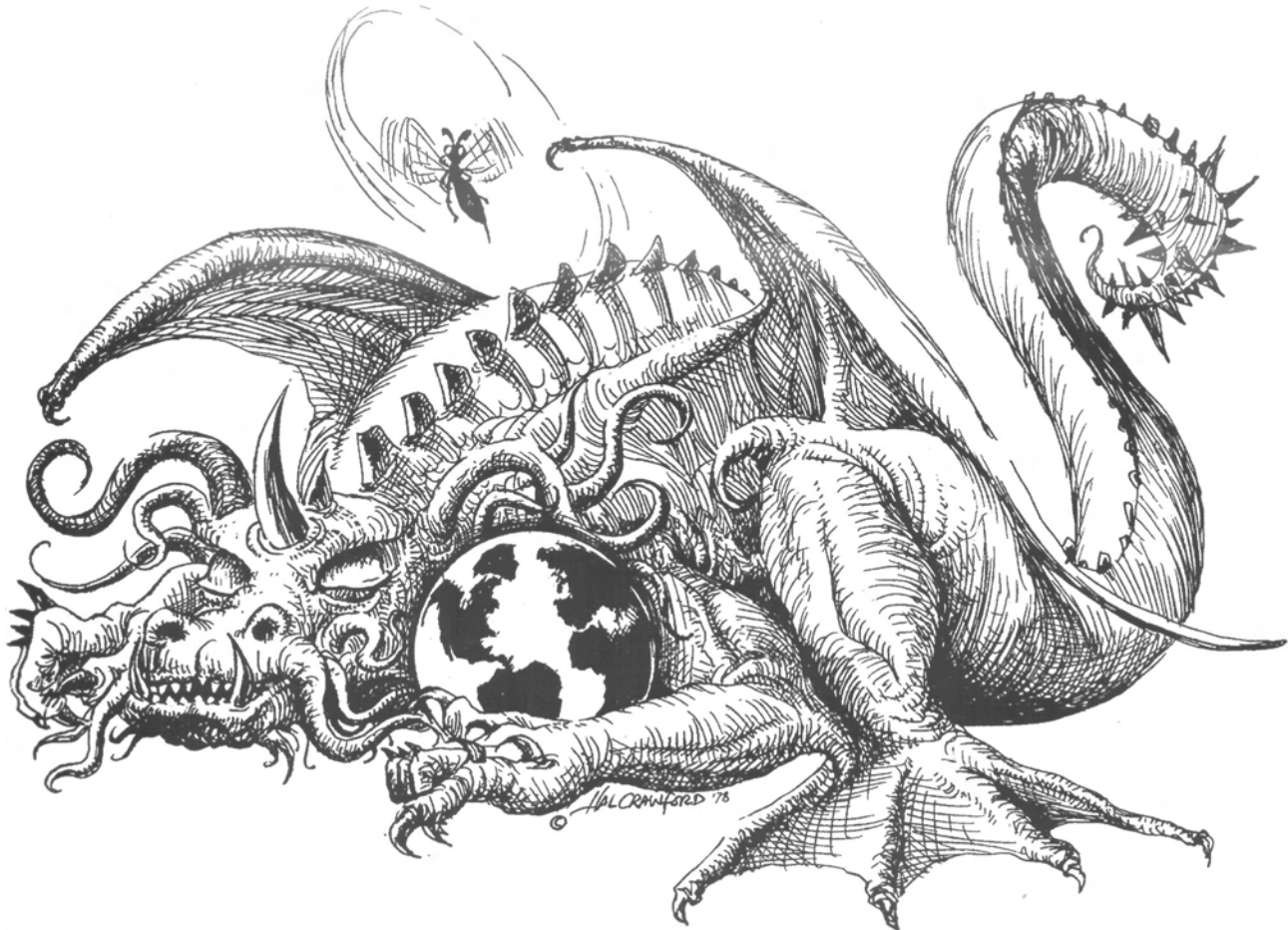

Fig. 40. ZARG

slowly been rising, and paranormal phenomena have been increasing, as have changes in reality such as the kindling of new fundamental particles. Even the sun has responded, suddenly decreasing its temperature. If we had applied psychotronics to develop a mind linkage mechanism, there would have been no need for Armageddon's destruction.

Let us hope we fare better than the Atlanteans. One may speculate that an Atlantis of sorts did exist, and that the Atlanteans built psychotronic devices out of crystals, bronze, gold, silver, and wire and unleashed them on each other in war. This sting stirred ZARG mightily, and in a resulting frenzy it simply destroyed the continent, stirring floods, storms, earthquakes and volcanoes worldwide. In the case of the Atlanteans, only a relatively small portion of humanity was involved; the percentage of persons and minds involved was apparently insufficient to cause full wakening of ZARG and linkage of the species. In the present case, the greater part of mankind is involved, and so the wakening is to be far more complete (as well as more violent). ZARG should be shocked into full wakefulness, and linkage should occur.

If so, a new great superbeing will have emerged; nonphysical, almost infinitely dimensional, and godlike. It will not exist in a single time or a single world, but in a nowness and allness that defies timelike or spacelike description.

"For we know in part, and we prophesy in part.

But when that which is perfect is come, then that which is in part shall be done away.

When I was a child, I spake as a child, I understood as a child, I thought as a child; but when I became a man, I put away childish things.

For now we see through a glass, darkly; but then face to face: now I know in **part**; but then shall I know even as also I am known."

I Corinthians XIII, 9-12.

So the pieces of the puzzle are now fitted together. The present state of the human species is not its final development, and indeed a great change in that state is imminent. Man literally is and shall be a god, one with God, just as the prophets have foretold. And if we retranslate that ancient foretelling into more modern concepts, we see just how strange and transcendent is the final birth or becoming.

The UFO and tulpoidal phenomena have merely been the signs in the sky and in the earth, telling us what is to come, precognitive indicators from ZARG. Had we developed a metapsychology of the entire species, we would already have clearly understood the messages.

# VIRTUAL STATES AND HYPERSPACES

In physics today there are two separate kinds of reality: observable changes, which can be detected by instruments; and virtual changes, which cannot be detected by instruments, even in theory. The difference between these two realities depends simply on the size of the piece of action (energy x time, or momentum x length) making up the particular entity or change. Usually the absolute minimum observable change is taken to be  $\hbar/4\pi$ . Changes smaller than this are said to be "virtual" and undetectable, and changes larger than this are said to be "observable" and detectable. Virtual changes are not bound by the conservation of energy law and almost always violate it. Nor are virtual changes, bound by the conservation of mass law. And virtual photons can have nonzero mass.

For any instrumental condition in a detector, one may consider a certain momentum and a certain length to be involved in the mass change that spatially constitutes the detection. Let us call this critical length  $dL$  and examine its ramifications (Figure 1) for the finest possible detector—one that detects a single quantum change. Figure 1 shows two frames, the lab frame  $S$  and a moving (hyperspatially rotated) frame. We choose a moving object,  $M$ , in the moving (rotated) frame, with length as shown. Note that all these entities are to be represented as detected or seen by our physical detector (instrumentation system) in the laboratory frame.

As the velocity of  $M$  approaches  $c$ , the speed of light in a vacuum,  $M$ 's hyperspatial rotation angle  $\alpha$  approaches  $\pi/2$ . However, before the velocity of  $M$  actually reaches  $c$ —and before  $\alpha$  reaches  $\pi/2$ —the dimensional length projection of object  $M$  in frame  $S$  will contract to reach  $dL$  and fall below it. At that moment,  $L$  becomes *virtual* with respect to the detector and hence undetectable. Since geometrically an absence of length in a continuous frame  $S$  would correspond to a  $\alpha$  rotation angle of  $\pi/2$ , in quantized frame  $S$  we consider that angle  $\alpha$  "jumps" to  $\pi/2$  just immediately past the critical angle  $\alpha_c$ , which is defined as the angle of rotation at which  $L \cos \alpha = A L$ . Rotation just past the critical angle corresponds to a Lorentz-Fitzgerald contraction into the virtual state below the quantum threshold of the detector's observable universe. To an  $S$  observer or detector, object  $M$  at that point has lost its length in the direction of motion, becoming a wave front moving at the velocity of light and thus photonic (comprised of photons). To a quantum observer in  $S$ , mass turns into photons just short of a full  $\pi/2$  orthorotation, which means the process can happen with a finite amount of energy. This "jump" effect is not taken into account in the continuum Lorentz transformations of special relativity at present, and this is the missing link that has prevented a successful union of relativity and quantum mechanics. In other words, the final part of the orthorotation (acceleration to the speed of light) occurs in the virtual state—specifically, that part of the rotation lying between  $\pi/2$  and  $\alpha_c$ .

Further, we may now proceed to rotate object  $M$  past  $\pi/2$ , which constitutes rotation from zero in frame  $S'$ . Just before reaching an  $S$  angle of  $\pi$  (that is an  $S'$  angle of  $\pi/2$ ), in frame  $S'$  another disappearance below a virtual length threshold  $dL'$  will occur in corresponding fashion. Note that this second threshold  $dL'$  also has an exceedingly small but finite projection into frame  $S$ , in

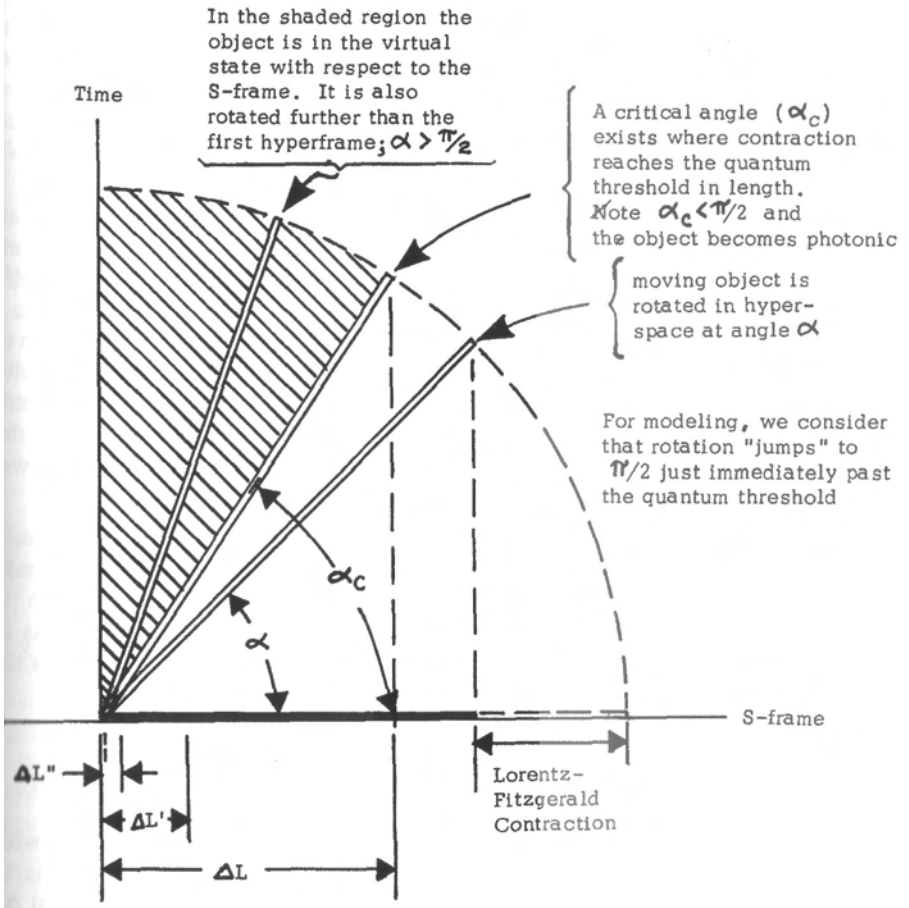

Figure 1. Hyperspaces, nested virtual states, and rotated frames

the virtual state lying inside  $dL$ . This second "relativistic quantum jump" in frame  $S'$  therefore constitutes a sort of second-level, nested subquantum threshold in frame  $S$ .

Continued rotation into hyperspace passes through successively finer, nested virtual sublevels or subthresholds in  $S$  by the successive breaching of deeper subthresholds due to continued Lorentz-Fitzgerald contraction. Higher hyperspatial frames constitute nested sublevels in the virtual state with respect to the laboratory observer. Thus a direct connection exists between virtual levels and hyperspace frames. Hyperspaces and virtual sublevels are the same thing. Every "virtual" object in  $S$  is an "observable" object in some hyperspace. *Hyperspatial engineering and virtual state engineering are one and the same thing, and this is what psychotronics and energetics are all about.*

Finally, time may be considered a sort of box containing all observables and virtuals. Indeed, time is neither observable nor virtual; time is simply a parameter in quantum mechanics. Rigorously, time may be said not to exist. Time itself is nothing, totally nothing; therefore by the fourth law of logic it can be said to be or contain everything, the total mishmash of virtuals and observables. Since in the absolute sense there is no such thing as time, then it is my thesis that all modeling of space, mind, thing, and nonthing must be done spatially. Relativity presently attempts to use time as an existent dimension of the same kind as length; it thus allows rotation of the  $S$ -frame only in the direction of the time axis in Minkowski geometry of spacetime.

Spatial modeling requires an infinite dimensional space and an infinite number of orthogonal angles. The time axis that can be drawn in such a hyperspatial model has no meaning except with respect to a relationship existing between two or more hyperspace frames or objects. Specifically, the time axis represents the totality of all the hyperspaces and their objects, hence all the relationships that can be separated from the hyperspace.

## FEYNMAN DIAGRAMS

Figure 2 shows something of the unsuspected nature of physical change, which is not nearly as simple as most of us have been led to believe. In the top part of the figure, an electron (represented by the arrow) is shown going from point A to point B a short distance away. In particle physics this diagram represents the movement of a bare particle; in other words, just a bare hunk of charged mass is considered and the fantastic number of other things happening along the way are ignored. In Figure 2b a virtual photon has been emitted and then reabsorbed by the electron between points A and B. Indeed, the charge on the electron is due to the continual emission and absorption of such virtual photons (little electromagnetic pieces of vacuum, one might say, or little pieces of nothing). So the situation with respect to virtual photons comes closer to Figure 2c: more than one virtual photon is emitted and absorbed—indeed, an infinite number of them are emitted and reabsorbed along the way from point A to point B.

But, worse yet, Figure 2d shows one of the emitted photons suddenly breaking up into a positron and an electron, which then quickly recombine back into an-



2a. Bare electron



2b. With virtual photon



2c. With nested virtual photons

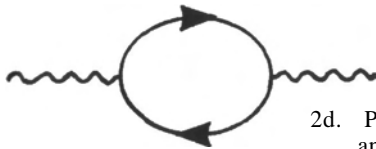

2d. Photon decay (pair production) and recombination (pair annihilation)

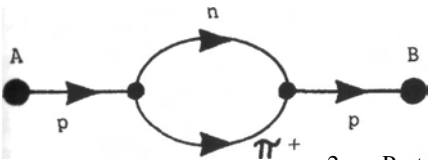

2e. Proton changing briefly to a neutron and a positive pi meson

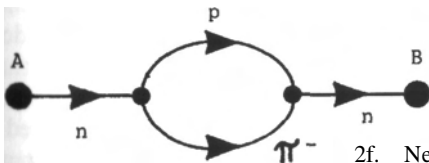

2f. Neutron changing briefly to a proton and a negative pi meson

Figure 2. Feynman **diagrams**

other photon, which is eventually reabsorbed into the electron. In fact, an infinite number of interactions happen while the "electron" is moving from point A to point B, and each of those interactions in turn consists of an infinite number of interactions, and each of those in turn consists of an infinite number of interactions, and so on. The simple movement of the electron is actually composed of a virtual cloud—an infinite number of an infinite number of an infinite number of things, all happening in a mad tangle of nested substrata in the virtual state (Figure 3)—and each of these virtuals with respect to frame S is in fact an observable in some particular hyperspace! Many other sorts of virtual particles are emitted and absorbed and born and extinguished, in addition to photons, by various observable particles and in free space. Everything in every possible world or hyperspace is related to each and every other thing in the laboratory world through orthorotations and nested virtual states. Crosstalk between hyperframes is the emergence and disappearance of virtual particles in a particular frame. The universe is holographic after all, and Mach's principle holds in a far more complete fashion than Mach himself ever dreamed. And if any part of this virtual chaos can be collected and cohered in even the slightest degree, any amount of observable free energy can be obtained, just as T. Henry Moray showed in the 1920s and 1930s.

In passing, I would like to call attention to Figure 2e, which shows one of the virtual interactions a proton can undergo in the nucleus of an atom. In this case, the proton breaks momentarily into a neutron and a positive pi meson, which then recombine into a proton. However, if the charge on the  $\pi +$  particle is extinguished psychokinetically during the existence of the neutron and the pi meson, the pi meson is converted to a neutrino and radiates away. In this case the proton does not reappear and the neutron remains. This decreases the atomic number (positive charge) of the atom by one, transmuting the atom into a new element, an isomer down the chain of elements. Figure 2f shows one of the virtual interactions a neutron can undergo in the nucleus of an atom. In this case, the neutron breaks momentarily into a proton and a negative pi meson, which then recombine into a neutron. However, if the charge on the  $\pi -$  particle is extinguished psychokinetically during the existence of the proton and the pi meson, the pi meson is converted to a neutrino and radiates away. In this case, the neutron does not reappear and the proton remains. This increases the atomic number of the atom by one, transmuting the atom into a new element, an isomer up the chain of elements. The two interactions shown in Figures 2e and 2f are involved in the Kervran effect, where elements are transmuted by living biological systems.

But back to our electron. If we now remove the electron, leaving empty vacuum, all the sorts of virtual madresses we have built up in Figure 3 are still there and still occurring. In addition, every other sort of virtual madness is also there and occurring. Vacuum is infinitely dense and filled with stupendous "zero-point" vacuum energy; it is totally chaotic and virtual. Space itself is an infinite tangle of virtuals—virtual projections from real observables in associated hyperspaces—and these dynamic interactants make up any three-dimensional space and hyperspace itself! They are also what cause space itself to exhibit the finite, nonzero parameters or values that must be accounted for in our physical equations. *Every fundamental constant of nature is dynamically constructed from—and*

258

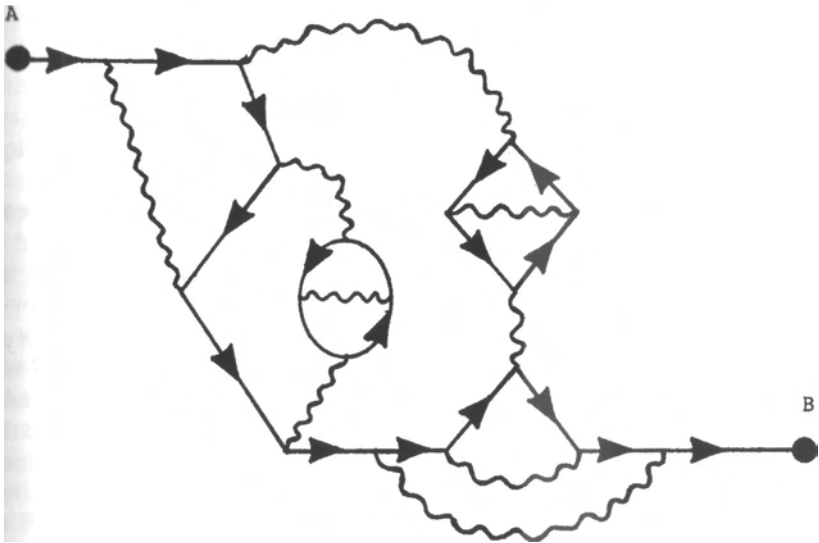

An electron moving from point A to point B is comprised of a bare particle and an infinite tangle of nested virtual particles

**Figure 3. Nested virtual processes**



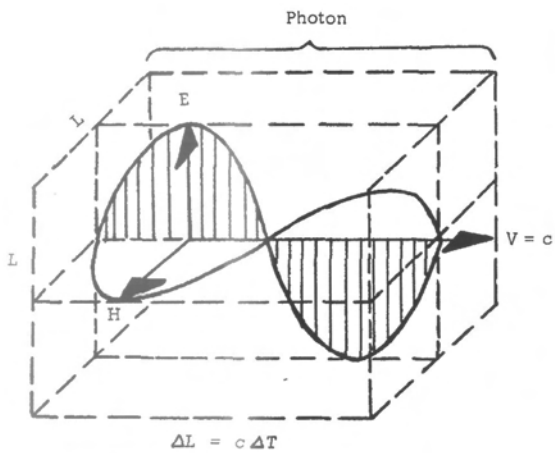

4a. A photon may be considered an individual  $L^3$  wavefront spread in time through one oscillatory period of the E-field and the H-field



4b. All three vectors of an EM wave are comprised of nested tangles of virtual subvectors

**Figure 4. Nature of the electromagnetic wave**

due to—the zero-point, virtual vacuum interactions that constitute "empty" space. The virtual "sea" of seething waves and particles that is empty vacuum is actually an ether—a Lorentz-invariant, nonmaterial (virtual) ether, perfectly admissible by the Michelson-Morley experiment and the entire experimental basis of physics. Indeed, Einstein once proposed naming the vacuum and its contained fields the "ether," but his suggestion was not heeded.

## NATURE OF AN ELECTROMAGNETIC WAVE\*

We now know something quite unusual about an electromagnetic wave and about a photon. Figure 4a shows how a photon may be represented. Here we find that a photon is a single oscillation of the E-field vector and the H-field vector as shown in the diagram. Since the oscillation is with respect to time, the wave moves along the axis of velocity in the S-frame for a single wavelength, then repeats itself again and again. The E- or H-oscillation actually represents an orthogonal, rotating etheric or hyperspatial flux about the velocity vector; this spinning (exploding and imploding) flux is coming into the S-frame from outside it (from virtual states) and returning (into virtual states). It is a neutrino flux, as we shall see. In the photon, half a sine-wave cycle represents the fission action that splits the action quantum into canonical pairs, while the second half of the sine-wave cycle represents the fusion of the canonical fragments back into an action quantum. One half-cycle thus represents a positive time operation or creation, while the other half-cycle represents a negative time (fusion) operation. If the complete sine-wave cycle has sufficient amplitude (energy), it can sometimes be broken in half, with the positive time portion revealing the negative field (negative charge) of the E-vector, while the negative time portion reveals a positive field or charge of the E-vector. This is pair production, the creation of an electron and a positron. Each of these fragments has spin one half, while the photon quantum has spin one. Since the positron is a fusion interaction existent, it is an "electron traveling backward in time," just as predicted by Dirac.

In Figure 4b I show that both the E-field vector and the H-field vector are composed of an infinite number of virtual vectors, each of which is composed of an infinite number of even smaller virtual vectors, and so on. This follows from the fact that during any time interval—including the period of a single oscillation of a photon—a photon may be considered to consist of an infinite number of virtual happenings, each consisting of an infinite number of subhappenings, and so on. The photon itself may then be considered to have a direct, nested virtual substructure, and this substructure is directly hyperspatial in nature as well. This structure has not been considered in Maxwell's field equations, which have been

\*Actually the electromagnetic field is not the most fundamental field, but is something that is torn out of, or separated from, a more fundamental field: the vector potential, or A-field, well-known in particle physics but usually ignored in EM field theory. E.g., magnetic field is created (and defined) by  $\nabla \times \mathbf{A} = \mathbf{B}$ . Looking at the cross product, by definition B field is the line integral about a small surface of the A-field flux through that surface. That is precisely what a single coil of wire, with an electrical current flowing through it, does and therefore creates a magnetic field inside. See the second volume of Feynman's three volumes of physics for more on the A-field. The direct use of the A-field is also psychotronic engineering.

formed from gross macroscopic considerations of bare particles and continuous fields. Maxwell's equations (and the normal concept of an electromagnetic wave and single frequency) thus represent only gross envelopes of the actual form and structure of waves and fields. As I have already shown in the main body of this book, one can even photograph the hyperfield structure of a magnetic field using a simple bar magnet and a color TV tube. Further, we will find that this virtual structure of a photon can be altered, "modulated," or changed by simple signal modulations, among other methods. The only requirement is that we learn to regard modulations differently.

In addition, inside each half-cycle of a photon's E-vector, relatively instantaneous fluctuations and "losses" of the vector's magnitude occur. At these "E-field glitches" in the photon, it actually contains only an H-vector. In this case the photon is a neutrino momentarily—or, in other words, it will admit a neutrino through the E-field glitch. The greater the charged field (voltage potential), the greater the number of photons available, thus the greater the number of neutrino interactions within the field. A potential of about 200-300 volts per meter altitude above the earth's surface normally exists in our biosphere. Many neutrinos emitted by the sun and bombarding the earth are absorbed in or interact with this E-potential above the earth; hence underground experiments to measure the neutrino radiation from the sun have detected less neutrinos than expected.

Momentary H-field glitches exist in a similar manner and interact with or admit neutrinos in a similar fashion.

Light can thus conduct neutrinic waves containing bioenergy or optoc energy, as T. G. Hieronymus discovered. In the first hyperframe (EM field frame), this can be seen to be simply a space charge of electrons conducting a wave disturbance through it, or a piece of ordinary conductive matter conducting an ordinary EM wave.

## NEUTRINIC LONGITUDINAL POLARIZATION WAVES

In Figure 5, I assume that in some fashion the E-field of an electromagnetic wave has been stripped off, leaving a single vector in the H-field direction only, and this vector is still oscillating, as originally set up in a Hertzian wave in Figure 4. The new "single-field" wave is an etheric sort of half-wave, a longitudinally polarized wave that is not a wavefront (plane) moving through S-space but just a pulsating line segment moving through S-space. This wave is not Hertzian. It is not electromagnetic—though it will strongly interact with or even produce electromagnetic waves—but is neutrinic. The interactions of this wave with space virtuals are drastically reduced (indeed, by a factor of  $c$ ), and this neutrinic wave now travels at the speed  $c^2$  with respect to S-space. While it will highly interact with magnetic field, precisely speaking it is not a magnetic wave but a hyperfield

\* $C^2$  is its s-frame, free-space velocity when not interacting with electromagnetic field. Normally, neutrinic wave interacts with electromagnetic field, thus moving at less than  $C^2$  velocity in space, since it "circulates around" in electromagnetic field. Neutrinic wave can be regarded as a circulating or spiraling wave in electromagnetic field, which may well be the

wave. It will travel through and across dead shorts, through media such as seawater and earth, and acts or can act much as a neutrino. This wave has neutrinoic components in  $S$ ; that is, it has vector components existing in frame  $S'$ . One may expect this wave normally to be active in or interacting with an electrostatic field or a magnetic field, as a special sort of lower-level virtual state flux (second-order hyperflux) into and out of the field. This is apparently the sort of wave discovered and used by Nikola Tesla, who repeatedly insisted that he was not using Hertzian (Maxwellian) waves but instead was employing a much finer wave having very different characteristics. Further, neutrinoic waves will transit between any two points on earth almost instantly—in fact, about  $3 \times 10^8$  times as fast as the speed of light propagates! With these waves, space communication with distant galaxies is practical and achievable, and scientists seeking communication with extraterrestrial civilizations would do well to use such waves.

Note that I am not referring to the ordinary longitudinally polarized electromagnetic wave, where both the E- and H-vectors still exist but the H-vector is rotated  $90^\circ$  so as to lie in the line of motion through  $S$ -space.\* Such longitudinally polarized electromagnetic waves are already known in the literature and have been used in many patented devices, but they are not included in most textbooks on electromagnetic fields and waves for some unaccountable reason. The normal longitudinally polarized electromagnetic wave moves at the speed  $c$ , just as any other EM wave.

At any rate, neutrinoic longitudinally polarized waves often arrive at a distant point many times stronger than they were when they left. T. Henry Moray, for example, built a radio and a sound detector that apparently worked by a version of neutrinoic waves, condensed into electromagnetic waves in his radio-detector apparatus. Dr. Moray tested the radio scores of times between 1930 and 1933, and on several occasions even received broadcasts from Admiral Byrd's party in the Antarctic. Even when powerful, ordinary radios could receive nothing from Antarctica because of severe weather conditions, Moray's little batteryless radio brought the broadcasts in, loud and clear with no static. Further, Moray demonstrated a sound pickup device of similar construction that could pick up or zoom in on sounds five miles away. Again the sounds were loud and clear, with none of the distortion of weather conditions and background noise. (See T. Henry Moray, *The Sea of Energy in Which the Earth Floats*, 4th ed., 1960, pp. 129, 133, and 143.) Thus transmission of power without wires was possible, just as Nikola Tesla had shown. Tesla in fact patented a capacitive (E-field only) transmission system.

Indeed, according to independent research by Dr. Robert Beck, another inventor named Rogers apparently discovered just such a system and the United States

"spinning wave" of orgone energy identified by Reich. Neutrinoic waves particularly interact more strongly with strong E-field and with strong B-field, the degree of interaction increasing (probably nonlinearly) with the intensity of the E or B field with which the interaction occurs. The velocity of neutrinos, measured on earth inside its strong ionosphere-to-earth E-field, should be quite reduced from the velocity of neutrinos measured in isolated deep space, and almost two-thirds of the neutrinos entering the earth system from space interact with the ionospheric-earth potential and are absorbed by it. The A-field and its derivatives directly involve the E-field, H-field, and neutrinoic field and their interactions. To correctly understand the activation chemistry theory and results of LeBon, A-field theory is required. And to understand much of Tesla's work, A-field theory is required, for Tesla was aware of, and used, A-field interactions in many of his patented systems.

Neutrinic wave interacts primarily with E-field or with H-field. Its group velocity may move at any speed between  $c$  and  $c^2$ , so that the wave can "ride" either photons or virtual photons

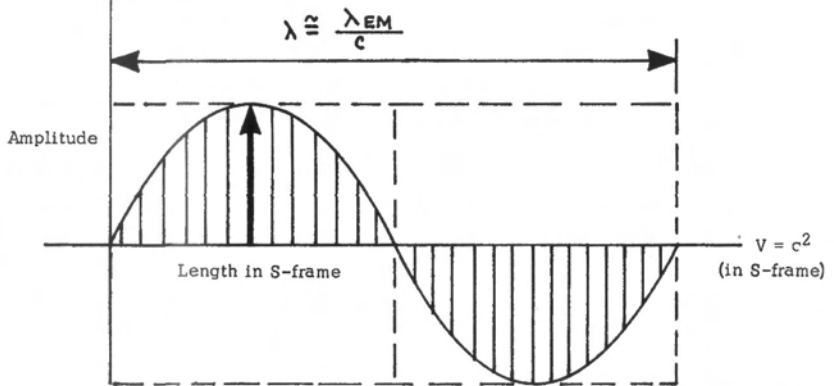

**Figure 5. Neutrinic (longitudinal polarization) wave**

**NOTE: This is not an electromagnetic wave and is not the longitudinally polarized EM wave familiar to many physicists and engineers.**

used it to communicate with its submarines underwater during World War I! For that purpose it was known as the Rogers underwater and underground wireless system, and H. Winfield Secor in 1919 reported on its use and its fantastic potential for the future, implying the necessity to completely change our ideas of electromagnetics and power transmission. (H. Winfield Secor, "The Rogers Underground Wireless," *Electrical Experimenter*, March 1919.) Mysteriously, the Rogers wireless seems to have promptly disappeared. Even more strangely, according to Dr. Beck's research the same breakthrough has been made again in the U.S. at least three times since the beginning of World War II. These rediscoveries included full delineation of the prior technologies, with mathematical theory and diagrams, that had escaped further notice. Again the technology disappeared mysteriously in all cases shortly after being rediscovered. The Soviets did not have far to look to discover the Rogers Wireless, Tesla waves, T. Henry Moray's radiant energy device, the Moray radio, the Moray sound detector, and the U.S. technical work in the area since World War II. All they really needed was to thoroughly examine the U.S. scientific and technical literature, the technical magazines and books, and so on. The Moray amplifier and the Moray sound detector were also demonstrated by Moray to a Soviet scientist, Dr. A. A. Yakovlev, in October 1929, and a Soviet agent succeeded in penetrating the Moray laboratory in 1939, obtaining drawings of the Moray tube and many photographs, and personally working in the laboratory for two months.

One may consider power transmission through such a wave to have traveled to every point in the future path at a speed that is faster than the flow of macroscopic time by a factor of  $c$ . Then along any electromagnetic (time) line along the same path, these waves are "ringing" back and forth continually, as the progress of normal physical change crawls slowly forward. Thus the normal time change (electromagnetic or photonic interaction world flow) acts as a collector for the ringing neutrino energy, and this collection can act as a gain factor  $G$ , where theoretically  $G$  is given by the expression

$$1 < G < c.$$

Thus a longitudinal polarization wave, when transmitted to a distant receiver, may arrive or be detected at the receiver thousands of times stronger than the transmitted signal, even for very low coupling.

Neutrino longitudinal polarization aspects to ordinary electromagnetic waves can also be achieved by modulation—especially by second-order, nested modulation—and such hyperspatial aspects have already been detected in the Soviet communications radiation, causing interference around the globe in the 10 to 20 megahertz range, as we shall see.

## A NEW LOOK AT MODULATION

We can assume a sine-wave electromagnetic carrier frequency whose amplitude we wish to vary (modulate) as a function of time, by a lower frequency sine wave, as shown in Figure 6a.

As is well known, the classical view of amplitude modulation of a carrier wave holds it to be an oscillatory change in the amplitude of the carrier, as shown in Figure 6b. However, empirically this was found to be erroneous, since in 1929 it was shown that after such modulation the detected carrier appeared unaffected by

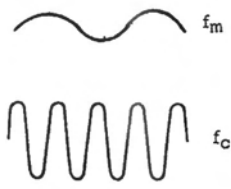

6a. A carrier  $f_c$  to be amplitude modulated by frequency  $f_m$



6b. Original view of amplitude modulation

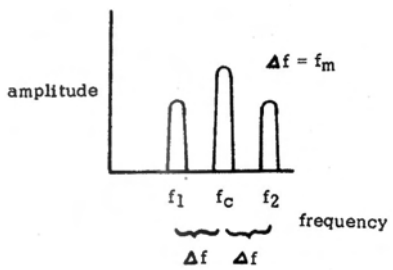

6c. Detected signal for an amplitude modulated wave

**Figure 6. Amplitude modulation of a sine wave**

the modulating wave; instead, there appeared two other sine-wave frequencies (sidebands), one at a frequency above the carrier frequency and one below it, as shown in Figure 6c. In each case the change in frequency from carrier to sideband was by an amount equal to the frequency of the modulating wave.

Both the original classical view and the present view are in fact correct if one considers hyperspatial aspects and linear detection aspects. As can be noted in Figure 6b, the carrier is distorted and is not a sine wave according to the original classical view. This implies that the individual photon shown in Figure 4a has been internally distorted or "bent." This, I submit, actually happens and constitutes the bending or curving of spacetime in a general relativistic fashion. However, all our instruments can detect only a pure, undistorted photonic interaction; that is, in frequency they can only detect the sine-wave aspects of a kinked photon. The reason is quite simple: for example, suppose the method of detection of the photon is by photon interaction with a bound electron. The change in the electron is a precise change of energy levels to an excited level, and it only detects or interacts with a single sine-wave photon. The frequency (say, the carrier) component of the photon, which contains the correct energy differential (according to  $E=hf$ , where  $h$  is Planck's constant and  $f$  is the sine-wave frequency), will interact with the electron. The other sine-wave components of the initially kinked photon will thus be stripped off (demodulated) by the absorption of the carrier portion of the photon. The photon kink existed in both positive time and negative time; from a frequency viewpoint, the modulating amplitude frequency that was added to the basic carrier frequency in positive time was subtracted in negative time. Thus demodulating the kink from the amplitude modulated photon (by absorbing the sine-wave carrier) results in the production or liberation of two sine-wave frequencies, one above the carrier frequency and one below the carrier frequency, each difference being equal to the original amplitude modulation's frequency. These two frequencies will then interact and be detected.

So our linear instruments do not detect single kinked photons in a stream of distorted photons, but they detect a combination of undistorted photon streams (waves) at different frequencies.

Such considerations as these should have appeared in electromagnetics long ago. After all, we presently regard an EM wave as a wiggle of nothingness, existing in time. This is precisely the same as saying that a photon is an oscillation (wiggling) of spacetime itself. Specifically, it oscillates in two directions spatially, one being the E-field direction and the other being the H-field direction. But since an EM wave itself constitutes a regular bending and flexing and curving of spacetime, including both space and time, then the flexing spacetime inside the photon can itself be further bent or twisted, and that constitutes a kinked or curved photon—a *modulated* photon. Our linear laboratory space instruments, however, will demodulate such a kinked photon into its linear components, giving a combination of unkinked photons in the detection. And for the amplitude modulated carrier shown in Figure 6b, we actually detect the carrier and two sidebands shown in Figure 6c.

Similar complex mixes of waves at different frequencies result for other types of modulation, but this will suffice for our purposes here. Specifically, we should mention that an infinite number of sidebands may be produced, but normally all



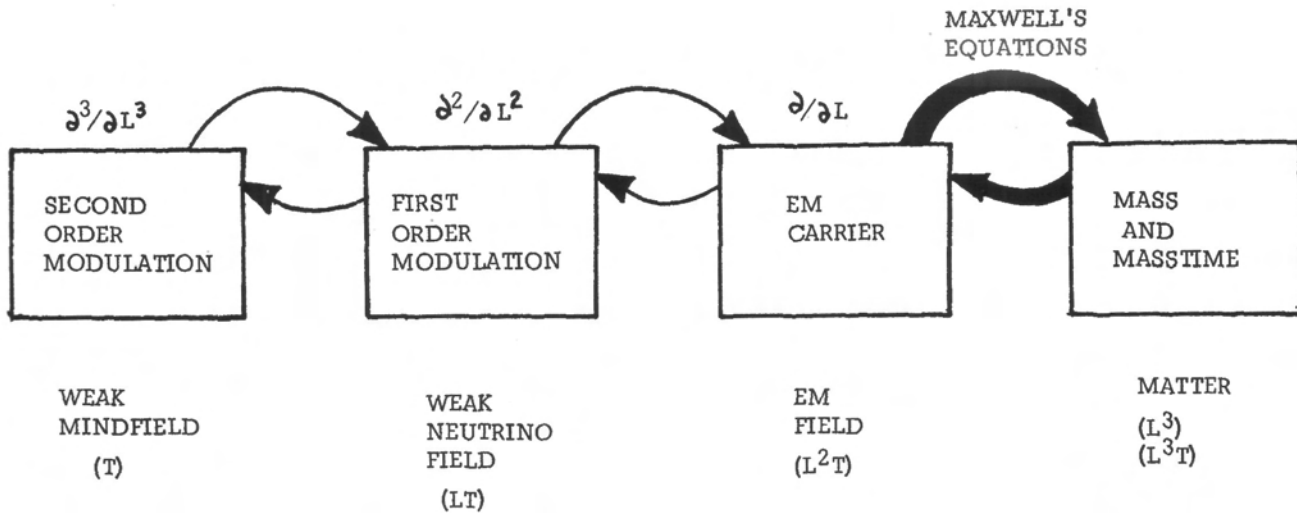

Figure 7. Nested modulations: key to hyperspace

but a few are so weak as to be negligible for ordinary communication purposes, where no hyperspatial information is needed. For living systems, however, a great number of these extra sidebands must be taken into account, for the hyperspatial-virtual state components carry the lifestream, consciousness-loop-interaction Information itself. We will look at some of the biological aspects shortly.

At any rate, modulation of a wave results in direct changes in the virtual structure of the formerly unmodulated photon, relativistically warping or curving it. Just as Fourier (harmonic) analysis breaks down a very complex nonsinusoidal wave shape into an infinite series of component sine-wave frequencies of various amplitudes, so linear detection in a linear laboratory frame breaks down a stream (wave) of complex nonsinusoidal photons into a series of sinusoidal waves in a complex mixture.

And if we now think of this in reverse, we see that a mixture of waves and frequencies must automatically possess, carry, or represent hyperspatial-virtual patterns in the correct nonlinear medium that absorbs them.

## HYPERSPATIAL ASPECTS OF MODULATION

Let us now look at the hyperspatial aspects of modulations and complex electromagnetic waves, particularly mixtures of waves, in yet another fashion.

First, as is well known, we may represent a wave as a sine function (or cosine function if preferred). When we modulate a wave, we impress a time change on it. In the most general mathematical sense, a modulation to a wave is the impressing of a derivative function upon the wave. And if we think of the basic carrier wave as being prescribed by Maxwell's equations in derivative form, then in a sense when we modulate the wave we differentiate it, that is, we impress a differential operator function on it. But this means that we raise the order of the differential equations prescribing the situation, which mathematically means we have increased the dimensionality or spatiality of the, wave entity that is the resulting modulated carrier. In other words, to modulate an electromagnetic carrier wave is to add a hyperdimensional aspect—specifically, neutrinic vector aspects or mind aspects. The whole affair can be thought of as merely shifting or altering the particular distribution of nested virtuals transported by the basic carrier wave.

If we differentiate a sine wave, we simply get a cosine wave, which is just another sine wave  $\pi/2$  out of phase with the first. So now it emerges that when we form a mixture of waves, we are adding virtual aspects (and hyperspatial aspects) in so doing, because of the phase differences. This is extremely important: *complex mixtures of waves automatically constitute and carry hyperspatial components!* And if we can accurately control these hyperspatial components, we are in effect doing direct hyperspatial engineering and virtual state engineering.

Now if we carry our modulation-constitutes-differentiation concept one step further, we find a most startling phenomenon (Figure 7). The first-order modulation we placed on an EM carrier we discovered to carry aspects of the next hyperspace, namely, neutrinic vectors. Now if we further modulate that first-order modulation signal as a carrier itself, so that we now have two orders of modulation upon the basic carrier, the second-order modulation must possess hyper-

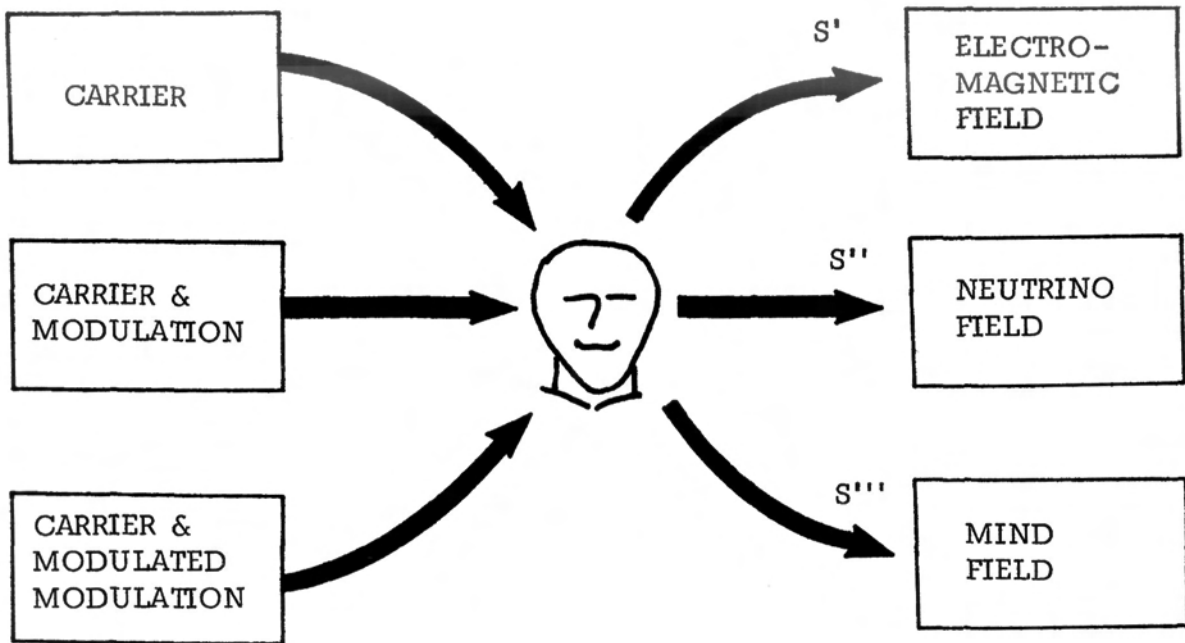
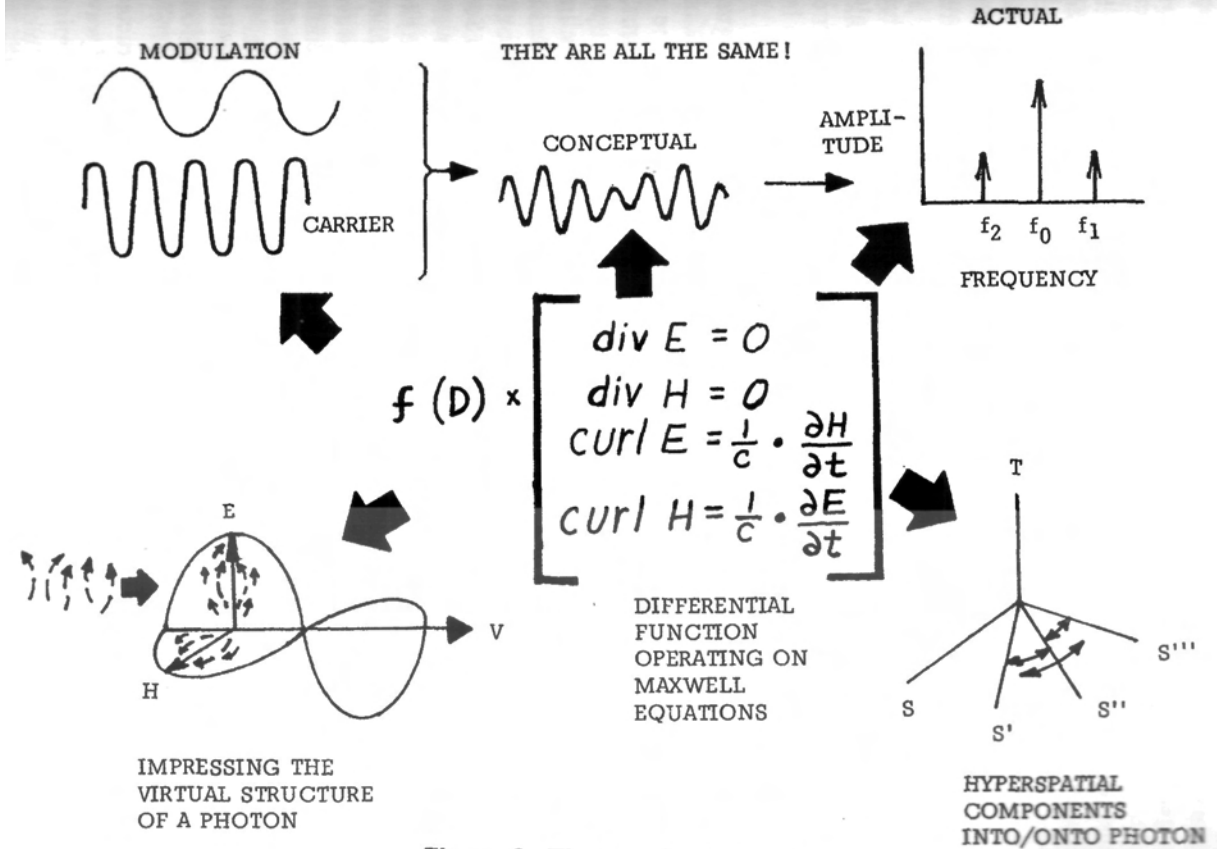

Figure 8. Field coupling to the human brain

THE EUREKA CONCEPT



**Figure 9. The Eureka concept**

vectors of the next higher hyperspace—the mindfield itself. In other words, by using two orders of modulation on a carrier, we can directly affect mindstuff itself. So if the correct overall pattern of these complex modulations are impressed on a carrier, the life-consciousness loop itself can be directly affected or shaped, all the way from the mindfield of a biological organism to its neutrino field to its virtual photon field to its biophoton field to its body tuner, and back. With the correct pattern we can stimulate the life channel for a particular organism, and with yet another pattern we can inhibit the life channel for the same organism. By this means a positive cure for cancer could easily be derived, and as we shall see, this already has been done. By the same means, a "death ray" for use against humans could easily be developed, and it is my contention that the Soviets have already long since developed such weapons.

It is my purpose to eventually use these new aspects to construct a direct mind-link for mind-to-mind communication and hyperlinkage, thus solving the human problem.

Figure 8 shows the basic scheme for coupling such a second-order modulated signal to a human being. We will return to modulations versus nested virtuals and hyperspatials below.

## THE EUREKA CONCEPT

So we have now reached a Eureka point of the first magnitude (Figure 9). Hyperspatial engineering, virtual state engineering, curved space, photon kinking, mind-life-consciousness engineering, and nested modulation are all the same thing! We directly engineer the virtual state, hyperspace, curved spacetime, and the life-consciousness loop itself, including the mind, with relatively simple devices that accomplish, transmit, and receive nested orders of modulations. Indeed we have opened Pandora's box, for this is the greatest tool ever dreamed of by humankind. Consequently it can be used either for the good of mankind or for its detriment. And this tool appears already to have been weaponized by the Soviets,

In Figure 9, note that modulation, photon kinking, the appearance of sidebands with the unchanged carrier, impressing a virtual pattern upon a photon, and impressing hyperspatial components into or onto a photon are equivalent. Further, if we assume that the electromagnetic wave (pure, undistorted wave in a linear medium) is given by Maxwell's equations, then modulation mathematically consists of impressing a particular differential operator function and a nonlinearity upon Maxwell's equations. For each modulation pattern, a particular virtual structure is impressed on the photon, which is the same as impressing a particular hyperspatial pattern upon it. Each specific pattern impressed on the photon (that is each particular kink pattern of the photon) corresponds to a specific differential operator function. Through this means, a specific theory can be constructed empirically. That is, one can work out the effects of various mixtures of waves on specific biological systems, measure the specific channels used by the mind-life-consciousness loop, and so on. The Lisitsyn paper and Kazhinskiy's "biological radio" work in fact state that the Soviets have already done precisely this, and the Kaznachev paper shows that a large number of related biophoton experiments were in fact carried out in Soviet military laboratories. But let us look at some very important and exciting German work directly related to this area.

## **BIOPHOTONS AND VIRTUAL EM FIELD OF A BIO-ORGANISM**

In an incredible piece of work, "Photon Storage in Biological Systems," in *Electromagnetic Bio-Information*, Urban and Schwarzenberg, Baltimore, Md., 1979, pp. 123-149, Dr. Fritz Albert Popp has presented the results of his laboratory work—and his theory—dealing with quite new developments in biological organism fields. Indeed, this may be one of the most important Western papers ever presented, if its true import is noticed. Briefly, in studying cellular electromagnetic bioactivity, the cell behaves as a system far from thermal equilibrium. It thus can be characterized as a Prigogine system. (Ilya Prigogine received the Nobel Prize in 1977 for his development of nonlinear thermodynamics of systems far from equilibrium, thereby changing the second law of thermodynamics.) We now know that in such a system negative entropy can result, and order can emerge from disorder. For a wildly disordered system, large-scale order can emerge and stabilize, and the more chaotic the disorder, the greater the stability of the ordered patterns that emerge. (Which seems to imply a confirmation of my fourth law of logic—total disorder must inevitably turn into total order.)

At any rate, living cells produce coherent light with a laserlike activity. This coherence serves as a control for the metabolism of the cells, regulates growth, and fixes the reproduction rate. Further, the cell exhibits superconductive behavior.

Popp found that a living organism in fact possesses a living aura, a virtual electromagnetic field that pervades the entire organism with a virtual photonic flux. In this field, virtual photons are stored. The field continually receives inputs (virtuals) from the environment and is continually outputting biophotons, particularly in the near ultraviolet. This field, in which all cells are bathed and with which they all continually intercommunicate, tends to stabilize and cohere the organism. All this has been established by laboratory experiments, and all of it is directly consistent with my own hyperfields and nested-virtual-fields model of the living system's life-consciousness loop connecting its mind hyperworld to its physical body tuner. My model is consistent with Popp's work and extends it by adding the nested structures of the virtual field, thus connecting Popp's virtual field to the neutrino field and the mindfield.

And with this additional information in mind, let us return to our consideration of nested modulations on an electromagnetic carrier. Indeed, let us look at several examples of devices already applying the "nested modulation is hyperspace vectorial" effect.

### **THE PRIORE MACHINE**

The cure for cancer mentioned above is the Priore device in France, which has been curing cancer and other diseases for over a decade, much to the frustration of many members of the French Academy of Sciences.

Antoine Prior<sup>6</sup> is an Italian-born inventor who escaped from the Germans in World War II and fled to France. After the war Priore" purchased surplus equipment and eventually developed a strange machine that filled an entire room. A nozzle above a table in the center of the room emitted a strong ray or field, which Priore\* explained consisted of an electromagnetic wave in a magnetic field. Eventually the French government spent almost three million dollars for construction of a new, improved Prior<sup>S</sup> machine, because Priori had shown he could cure cancers in laboratory animals with the device.

In 1964 Professor Robert Courrier, renowned biologist and secre'taire-perpe'tuel of the French Academy of Sciences, presented some of Priore's results to the Academy. Forty-eight cancerous rats had been divided into two groups of twenty-four each. One group was set aside without treatment as a control, and the other group was divided into two subgroups of twelve each. One of these subgroups was treated by the Priore machine promptly after cancer grafts, and the other was treated after a lapse of several days. Both subgroups were completely cured—the first quickly and the second after more prolonged treatment. All the control rats died in twenty-two to thirty days after grafting.

The results created a furore and a controversy that have continued to the present day. Since the first presentation by Courrier, the machine has repeatedly cured leukemia and other forms of cancer in laboratory animals. The controversy seems to have arisen because the French Academicians could not comprehend the working of the machine, and because the inventor would not reveal how it worked but only how it was built.

The second, more powerful Prior<sup>6</sup> machine produces a magnetic field of about 1,240 gauss. According to one scientist, the machine contains a gas-filled vacuum tube, which contains a plasma of mercury and neon gas. A pulsed 9.4 gigahertz electromagnetic wave is modulated onto a 17 megahertz wave in this plasma. However, the true nature of the machine is revealed by the fact that the 9.4 gigahertz wave is joined in the "lamp" by seventeen radiations of unspecified frequency and nature. Thus we see that Priori is actually using second-order multiple modulations and is dealing with the direct life-mind-consciousness loop of the mammalian cell. He is directly stimulating and engineering the hyperspace nested virtual bands with his device. His twenty-six years of work have mostly been involved with ferreting out the required precise frequencies and mix of second-order modulations, as well as the correct intermodulation carrier necessary to obtain the desired effects.

In Figure 10 we show a simplified diagram of the Priore device, from which it can immediately be seen that the device uses the same principles shown previously in Figure 9. Prior<sup>S</sup> is using nested orders of modulations to affect nested orders of virtual state, thus producing direct channels and effects in neutrinic field and in mindfield. Radiating a biological target such as a laboratory animal with such a complex field directly engineers its mind-life-consciousness loop. With the correct nested modulations on the correct carrier (in this case a strong magnetic field, which allows a stronger connection to the neutrinic field aspects), the mind-life-consciousness loops of the individual cells in the body of the irradiated animal are "scrubbed clean" of any deviation from the norm by the virtual patterns delivered to the animal, and hence to its "virtual biophoton stabilization field" reported by

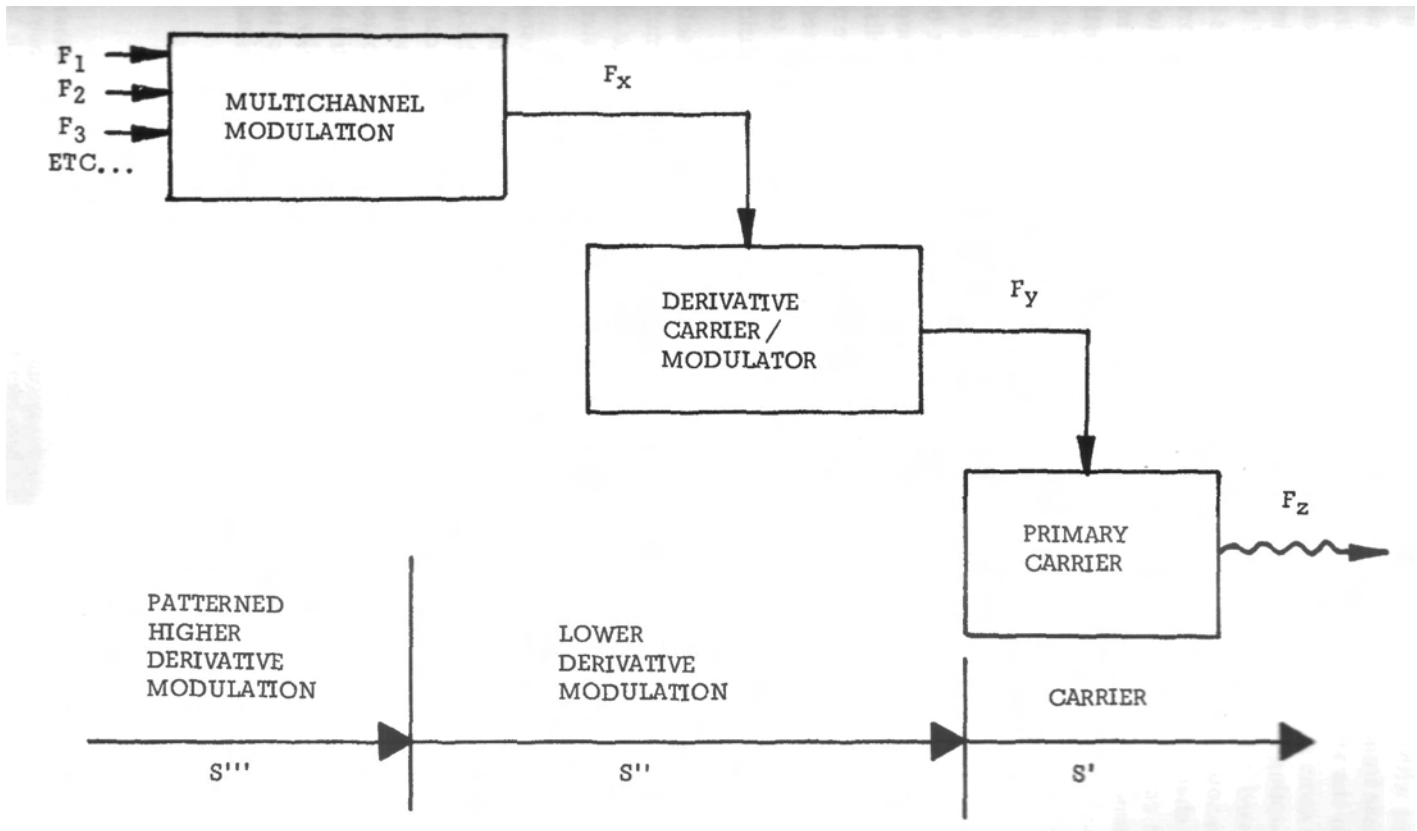

Figure 10. A simplified diagram of the Priori device



Popp. In other words, the Priore device produces a reverse sort of effect as compared with the Soviet work reported by Kaznacheyev on anomalous death and disease transmission between cell cultures by near ultraviolet biophotons emitted from the virtual Popp field of the dying cells of the stressed, attacked cultures. The same sort of virtual engineering that can transmit death of the organism (by disrupting its mind-life-consciousness loop tuning) can also transmit life into a stressed attacked grouping of cells by a sort of "forced resonance" of their consciousness loops into normal health patterns. (Virtual state interactions control charges, which control chemistry. Thus the entire chemistry of the absorbing cells can be controlled and engineered.) Also, the Lisitsyn paper refers to the presence of eleven independent channels in the brainwaves (namely, in the mind-life-consciousness connection to the waves of dendrite firings that constitute brainwaves\*), and these were specifically referred to clipped signals, not sine waves. (The clipped signals would be those possessing complex nested modulations, and thus representing the tuning effects of the life-consciousness loop.) The Priore machine uses seventeen higher-order modulations, which are quite sufficient to cover all eleven life channels required, with an additional six being available for tuning so as to squelch or "jam" the life-consciousness loops of those cells with tuning abnormalities, that is, of diseased or cancerous cells.

As we would expect, the Priore machine has also shown its ability to cure other infectious diseases and materially benefit victims of cardiovascular diseases. Infectious diseases cured by Priori radiation also provide an immunity to the treated host organism that has been shown to be transferrable by transfusion of blood samples.

Again I strongly emphasize that the individual biological effects of solitary magnetic fields or single frequency waves cannot be extrapolated to the multiple frequency, nested modulation case; and almost all our present knowledge of the effects of electric, magnetic, and electromagnetic fields on biological systems is woefully immature and incomplete.

T. Henry Moray built a somewhat similar machine—though very much smaller—which provided a direct radiation from extensive "peach blossom violet" colored sparkgaps inside a quartz tube, and which greatly stimulated the health of an individual exposed to the radiation. In fact, the device would promptly cure the radiation burns Moray frequently suffered as a result of his continual experimentation with uranium compounds and other radioactive substances. He patented the device, and some of his original machines are still in existence and still being used to treat patients with a wide variety of ailments. I have personally been exposed to one of Moray's treatment machines and can vouch for the fact that it stimulates every cell in one's body, providing in about two to three minutes a great tonic and health stimulant.

\*It is these dendrite firings which form the collector-detector mechanisms through which the mind-world changes are joined to the human nervous system and brain. Were they not specifically useful and needed, the dendrite firings would not have been developed, and nerves would simply be long wires.

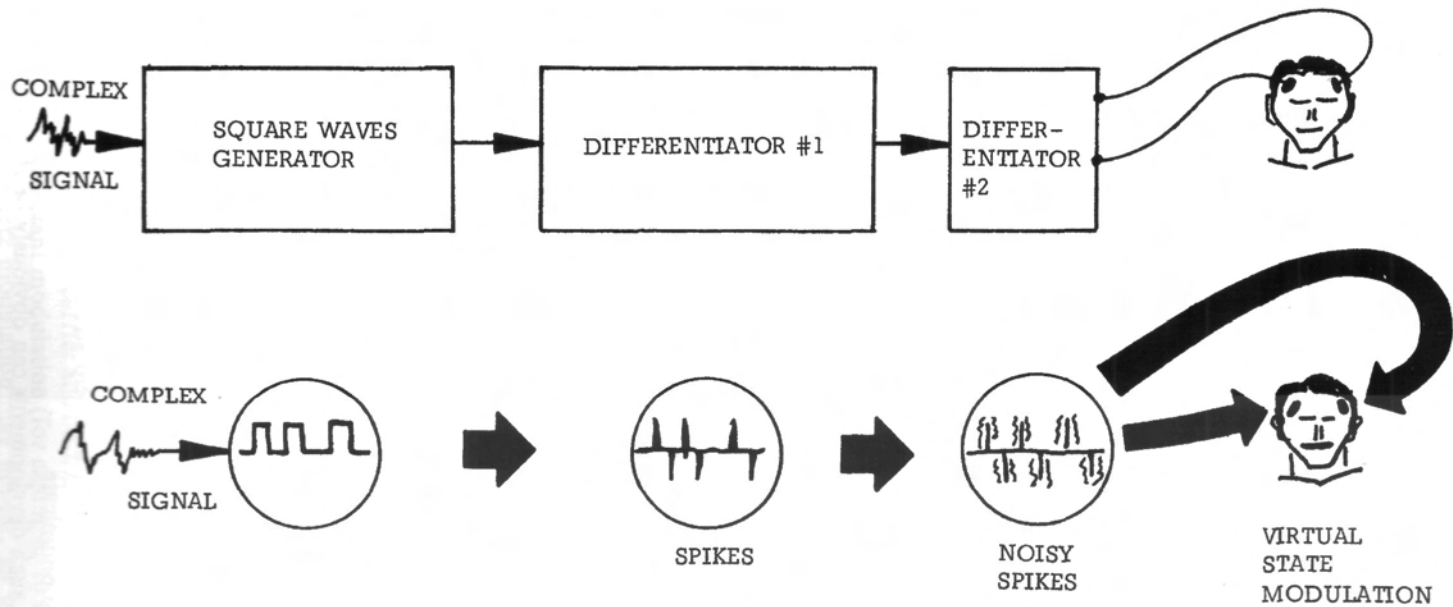

Figure 11. A simplified diagram of the improved Flanagan neurophone

## THE NEUROPHONE

Another device that uses the new hyperspatial, virtual state, nested modulation technology (and has done so for seventeen or eighteen years) is Dr. Pat Flanagan's neurophone. With brilliant insight and intuition far beyond that of science at the time, Pat invented and patented the instrument by the time he was seventeen years old. The neurophone is a device that, contrary to all present theory and knowledge, will directly "pump the brain" and reproduce sound and information directly in the brain and mind system, without going through the auditory system at all. A simplified diagram of Pat's improved neurophone is shown in Figure 11.

Briefly, the device takes a complex signal, such as the sound of an orchestra playing a musical interlude, and electrically processes it as shown in the figure. First the signal is passed into a section that clips everything into a series of square waves, remarkably analogous to the sort of clipped waves Lisitsyn confirms are the information carriers of the human brain. Next the square waves are differentiated, yielding a series of sharp spikes (note that these spikes retain the pulse-time content of the clipped signal). These spikes are again differentiated, and since these are finite spikes with real nonzero rise times and decay times rather than theoretical constructs, a series of noisy spikes results from the second differentiator section. From here, the noisy spikes are introduced to special contact electrodes, one of which is normally placed on the forehead, while the other may be placed almost anywhere, including on the foot. Nowhere are any sound waves introduced to the head.

The square-wave clipper section reduces the complex signals, their overtones, and their complex modulations to square waves, retaining the temporal content of the wave mix but not the waves themselves. The first and second differentiators heighten or filter through the temporal content of the higher-order differentiations, that is, they serve as a band pass filter unit to accent the time keying of the neutrinic and mindfield portions or aspects of the signal. When these time spikes are then introduced across the body as pulsed voltages, they are modulated directly on the dendrite firings of the brain and nervous system, providing direct and pulsed modulation of the neutrinic and mindfield component channels of the mind-brain-consciousness-life loop itself. Thus the neurophone directly inputs information into the brain and nervous system, bypassing all the normal sensory systems that lie between the mind-brain loop and the outside environment.

Indeed, a similar development has been reported by two University of Missouri researchers. Dr. Donald York, a neurophysiologist, and Dr. Thomas Jensen, a speech pathologist, have recently reported identifying and decoding twenty-seven words and syllables in specific brain wave patterns and correlating these electroencephalographic patterns with both the spoken word and the silently thought word in about forty subjects. At present, Dr. York and Dr. Jensen are programming a computer with a brain wave vocabulary, to monitor and read the EEG of a stroke victim's brain and help stroke victims who have lost their powers of speech to communicate.

While all such developments can obviously be misused, their potential for assistance to mankind is enormous. Indeed, my own premise that brain linkage it

possible and can be used to advance all mankind to the sixth stage of species evolution is slowly being proven. It is within our reach now to develop a multi-channel communications system that will directly link brains, minds, and consciousness into a single functional being; and I have already pointed out that the psychokinetic power of the emergent entity increases exponentially with the number of linked stages. The normal corpus callosum linkage of the two cerebral halves in each human head proves that brains, minds, and beings can be linked and integrated into one.

*The Excalibur Briefing* details the basic concepts of the theory involved in hyperspace-virtual state engineering, and thus in the engineering of mind-life-consciousness links to multicellular organisms here on earth. Pat Flanagan's neurophone proves that complex information can be implanted directly in the brain and mind, bypassing the normal isolating barriers. Drs. York and Jensen have shown that the brain wave does indeed contain recognizable, decodable information analogues. Lisitsyn has already reported measuring the number of independent channels involved and has documented the importance of the clipped brain waves as opposed to the sine-wave content. If we have the vision, we can still develop a brainlink and rapidly apply it to link sixty to one hundred persons, thereby opening a conscious, multidimensional "eye" for the collective human unconsciousness, gently rousing ZARG into wakefulness, and fulfilling human destiny without undergoing the psychotronic Armageddon planned by the Soviets. The time is short, but it can still be done if the funding, the vision, and the team can be established on a crash priority basis.

## **SOVIET "WOODPECKER" SIGNALS**

But, as I have said, all this can be used for the detriment of mankind as well as for its benefit. Unfortunately, it appears that the Soviet Union has chosen to weaponize the effects on a global scale. A prime example is the "woodpecker" signals emanating from the USSR in the 5-30 megahertz region and interfering with communications around the earth.

These complex woodpecker signals appear to originate from two or three dozen powerful Soviet transmitters, each with a power estimated as high as 40 megawatts (Figure 12). The pioneering experimental measurements of these signals by Dr. Robert Beck and William Bisehave shown just how deadly a potential may be possessed by the signals. These measurements have been performed in Eugene and Portland, Oregon; Los Angeles, California; Huntsville, Alabama; and several other locations. They have been particularly significant on the West Coast in and around Eugene, Oregon because of the presence of a direct current transmission line several hundred miles long, which has acted as a long wire antenna, picking up the signals and rebroadcasting them with appreciable gain in the vicinity.

Typically the signals may be found on, say, sixteen different carriers between 10 and 20 megahertz. Twelve of the carriers may appear normal, with normal sidebands, and the other four may have the carrier and both sidebands suppressed but still show the biologically significant modulation (for example, 10 hertz). On all sixteen channels a strong 10 hertz modulation may appear, all perfectly time

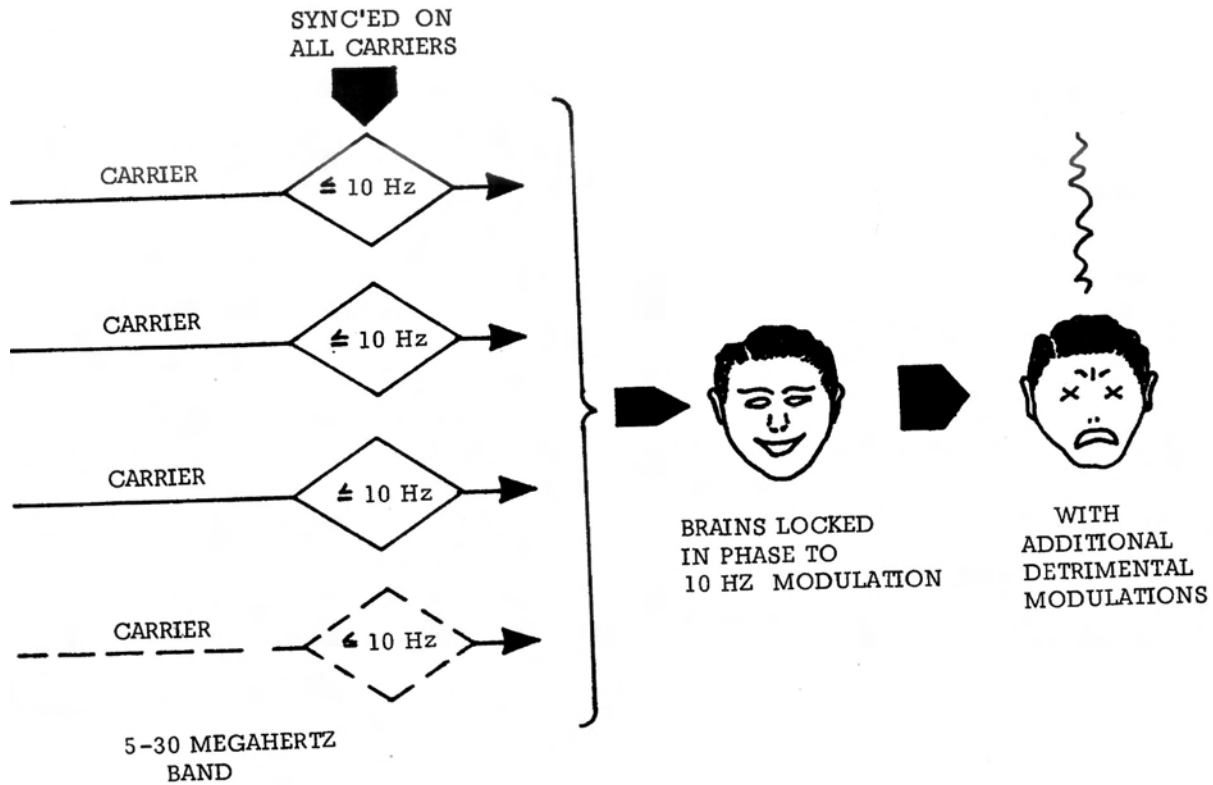

Figure 12. The Soviet "woodpecker" signals

synchronized and in phase channel-to-channel. The received signal from one of these carriers may be twenty-five to thirty times as strong as the earth's background magnetic field, which is oscillating at approximately 7.0 to 7.5 hertz. Other complex modulation frequencies, many of them changing, are present on the various channels.

Normally, the brainwaves of mammals in an area are gently entrained by the normal oscillations of the earth's magnetic field and are oscillating along at, say, 7.5 hertz. Under continuous radiation from the Soviet woodpecker signals, a percentage (say 30 percent) of the mammalian brains may be captured by the 10 hertz modulation on the overpowering Soviet signals. These captured brains are now in forced oscillation and are riding along in phase with the 10 hertz Soviet modulation. In other words, a certain percentage of the human brains in an area will phase lock to the 10 hertz modulation, and that will effectively lock into those brains the sixteen carrier frequencies with their concomitant frequency mixes and complex signal modulations. If the signals are made much more powerful (for example, by focussing them onto one particular area or increasing the power of the transmitters), then a much higher percentage of brainwave entrainment can be accomplished in the targeted area. By simply adding on the desired modulation patterns, the Soviets can now pump material directly into the mind-brain-consciousness-life loops of the entrained brains. The weapon implications are enormous: raw emotion such as sheer terror or panic can be transmitted; death or disease patterns of all kinds can be transmitted; informational content (thoughts and ideas) can be impressed directly into the captured brains and minds and processed as if originating inside each brain itself. Indeed, as long as the Soviets keep the effects rather gentle, an entire population can be subtly influenced without governmental notice. Certain specific ELF frequencies can rapidly disable or even kill, and for wartime use those frequencies can be directly implanted in the captured brains themselves by the woodpecker signals. It appears that 1984 came a little early, and one can perhaps now understand Brezhnev's strange 1975 proposal to the SALT negotiations that we should also consider outlawing the development of new weapons more frightful than the mind of man has ever conceived.

The signals also have direct application against strategic targets other than personnel. For example, by incorporating the correct nested modulation pattern, the positron kindling (electron squelching) pattern can be impressed. By beaming through the earth (with a circularly polarized signal or with other complex modulation forms), a beam with a strong neutrino component, which will squelch electrons and which will interact with great preference for strong voltages or strong magnetic fields, can be directed at a target complex. In the targeted area aircraft and communications systems can be disabled; automobile, truck, and other ignition systems will fail; power transformers and large motors and generators will fail; power transmission systems with their associated high voltages will fail; and so on. Even independent, self-contained emergency power equipment, such as at military installations and strategic missile sites, will fail to operate. Further, to some of these signals, the earth and the sea are as transparent as glass, and so underwater nuclear submarines can be electrically disabled on station before their missiles can be fired, while strategic missile complexes can be elec-

trically disabled before their deadly nuclear missiles can be hurled toward their distant targets. If some submarines and land complexes succeed in firing missiles before being disabled, these missiles can be electrically duded and scrubbed from the sky over Soviet territory while still far from their intended targets.

So, as stated at the end of *Excalibur*, the players are on stage and in place. The final act begins. One thing is sure—mankind will never be the same again after seeing the play!

**PART FOUR**

**SOVIET PHASE CONJUGATE  
DIRECTED ENERGY WEAPONS**



# WEAPONS THAT USE TIME-REVERSED ELECTROMAGNETIC WAVES

At the end of WWII, the Soviet Union obtained the cream of the crop of Germany's radar scientists and infrared scientists.

At that time, the German scientific team led the world in the theory and technology of radar absorbing materials (RAM) and radar cross section. For example, some leading Western radar experts believe that the German scientists had already advanced the theory of radar cross section beyond where Western scientists have arrived at today. Radar cross section science is the "heart" of modern radar technology, countermeasures, and counter-countermeasures.

The theory of RAM technology is precisely what is needed to develop and design phase conjugate mirrors for radar frequency bands. Phase conjugate mirrors are capable of producing a time-reversed (TR) wave in direct response to a received ordinary wave. The mirror may be powerfully "pumped" with energy to produce a very large amplification of the time-reversed wave.

Just after WWII, the Soviets also mounted a truly massive program to obtain and review all the scientific literature of the West. This material was completely re-examined and digested, in a deliberate search for a major new technological "break-through" area. Nothing similar to this has ever been done in the West.

By 1950, the Soviets probably had discovered phase conjugation and the time-reversed wave, in their radar programs using the German radar scientists. Their research would certainly have revealed that the time-reversed wave is a solution to the wave equation, and hence the phenomenon is universal to all waves and frequency regions, under appropriate nonlinear circumstances.

We stress the fact that from the beginning the Soviets have always led the rest of the world in nonlinear science and mathematics.

Thus by the mid-50's, the Soviets would have mounted an intensive national development program on these radar TR wave weapons. If so, the Soviet Union has now had the equivalent of some seven or eight Manhattan Projects, back-to-back, in the development, stockpiling, and deployment of TR wave weapon systems. At least fifth generation Soviet TR weapons have been developed and deployed.

This is a matter of the greatest importance to the U.S.—and one which the U.S. intelligence and scientific communities have largely missed.

We particularly stress that the time-reversed wave phenomenon is a universal phenomenon of nature, not just a fluke, and not just a "nonlinear optics" phenomenon. It is a solution to the wave equation and, as such, it applies to every kind of wave. Electromagnetic, sound, magnetohydrodynamic, and other radiating systems all exhibit the phenomenon under appropriate nonlinear conditions.

Hundreds of Western papers dealing with time-reversed waves are now in the open scientific literature—most of them dealing with non-linear optics. However, the principles of the time-reversed wave are well-established, and known to apply to waves in general.

Compared to a normal wave, a time-reversed wave has startlingly different weapon capabilities.

Such a wave precisely retraces the path of the ordinary wave that stimulated it to be formed. So it possesses an "invisible wire" through space, back to the original position of whatever emitted its stimulus wave.

Further, the time-reversed wave continually converges upon its invisible "back-tracking" path. It does not diverge and spread its energy, in contradistinction to normal waves.

Using several simple schemes (particularly pumped 4-wave mixing), extremely large amplification of the time-reversed (TR) wave can be cheaply and readily accomplished.

A startling weapons capability therefore emerges when amplified TR waves are generated in response to received signals from a distant target:

(1) If any signal at all can be received from a distant target, a return TR signal of extreme power can be delivered directly to that target. Almost all of the transmitted TR signal energy will arrive at and in the distant target, even through a highly nonlinear medium or under scattering conditions. Hardly any of the energy will be lost enroute. If the target is fast-moving, a "lead correction" signal can be calculated and added to steer the return path.

(2) Since real-time holography can readily be accomplished using TR waves—and without first making holograms, geometrical forms (balls, shapes, hemispherical shells, etc) of energy can be created readily by interferometry (crossed beam techniques). Since the TR wave carriers do not disperse with distance, these interference energy forms can be assembled by crossed TR wave beams at great distances—even hundreds of thousands of miles. The energy appearing in such a distantly created energy form is limited only by the amount one cares to put in at the amplified transmitting end.

Thus the radar itself now becomes a powerful, all-around weapon. With a TR wave adjunct, once the radar receives a return signal from a target, an extremely powerful TR wave pulse can be generated, and all the energy in that pulse can be unerringly returned to the distant target from which the return was received.

Even a passive (receive only) radar may be used together with a TR wave adjunct to accomplish the same directed energy destruction of the distant target emitting the signals received by the radar.

Radio receiver-transmitters may also employ simple TR wave adjuncts to provide a large number of communications jammers and "directed energy weapons," capable of jamming and/or destroying enemy radio transmitters at appreciable distances.

The Soviets have intensively developed such TR wave weapons since the 1950's. In January 1960, Khrushchev was probably referring to these weapons when he reported to the Soviet Presidium the forthcoming advent of fantastic weapons, then in advanced Soviet development.

Prior to Khrushchev's announcement, the Soviets had begun radiating the U.S. Embassy in Moscow with scalar EM waves and phase conjugate energy, modulated upon weak microwave carrier beams. Later these beams were used to induce illnesses and blood changes in Embassy personnel. (We will shortly discuss how the Soviets could induce disease at a distance, electromagnetically). The microwave radiation con-

tinued intermittently, in spite of the objections of several U.S. Presidents. U.S. studies failed to comprehend what was being done.

The Embassy radiation was and is a high-level intelligence probe: Stimulate and affect the U.S. Ambassador, a high-level target. Attention by the CIA, NSA, State Department, DIA, the U.S. President, etc. is guaranteed. Puzzled, they will turn to the U.S. scientific community for an explanation. The scientific community will try to explain the microwave radiation, using the best of its EM knowledge. By the U.S. counteractions taken or not taken at the Embassy site, the Soviets know with 100% certainty whether or not the U.S. has discovered TR wave weapons, electromagnetic disease control, etc.—and whether we have developed defenses against such weapons.

Since the beginning, of course, our actions—or lack of them—at the U.S. Embassy have consistently revealed to the Soviets that we have no knowledge of, and hence no defenses against, TR wave technology and the scalar electromagnetics (electrogravitation) that accompanies the phenomenon.

Soviet TR wave radar weapons also provide a convenient mechanism for accomplishing nuclear weapon kill. A target struck by a powerful TR wave pulse generates a time-reversed back-pulse due to nonlinearities in the target medium. In the nonlinear medium of the exploding or fuzing target, the two pulses (which are 180 degrees out of phase with each other) modulate each other, locking together into a scalar EM wave or pulse. This scalar EM pulse has zero electromagnetic force field resultants, but is a violent fluctuation of the energy density of local spacetime. Rigorously it is a local gravitational pulse wave, by definition. Further, it is far more powerful than "normal" gravitational waves. This scalar EM pulse does not react with the orbital electron shells of an atom, but passes directly into the nucleus and is absorbed there. This raises the nucleus to an excited state, increasing its potential (trapped energy). If the nucleus cannot withstand this increase in potential energy, it directly fissions. If the nucleus withstands the increased potential, it then immediately decays from the excited state by simply emitting a time-reversed EM wave.

Any radioactive nucleus is already "teeter-tottering" toward nuclear decay, so to speak, and it will instantly decay radioactively when struck by a significant scalar potential pulse. Thus a TR wave radar weapon can deliver a powerful TR pulse against a distant vehicle carrying a nuclear warhead, and the resultant EG pulse penetrating the nuclear material of the warhead will electrogravitationally explode it in a full-order nuclear detonation.

Therefore, when using such weapons, extreme care must be taken to avoid inadvertently pulsing one's own nearby nuclear weapons or nuclear material. In attacking distant ground targets, one must be careful not to detonate nearby nuclear weapons, nuclear powerplants, or stored nuclear material—even at some distance from the target. Otherwise, large-scale nuclear fallout will be experienced over a worldwide area, and unacceptable "boomerang" self-damage to the attacker himself may be incurred. The more powerful the TR pulse employed, the greater the safety separation between the struck target and stored nuclear material must be to prevent unacceptable "boomerang" large-scale fallout.

Also, large TR wave interferometer weapons, such as the Woodpecker systems, usually first produce very powerful, scalar EM "standing wave" beams by continuously transmitting (in the beam) both a normal EM wave and its phase conjugate.

modulated (locked) together to produce a "zero EM vector resultant" electrogravitational (EG) wave. Interference of two of these scalar EM beams in the targeted area, plus internal scanning within the beam by other signals, allows EM effects—of either normal EM energy or time-reversed EM energy—to be produced and controlled at very precise locations within the broad interference area.

Each such huge "scalar EM standing wave" beam represents a gigantic electrogravitational standing wave, and hence a giant oscillating potential in spacetime. This standing wave represents a sort of gigantic "capacitor", or accumulator of in-folded energy. Enormous energy may be collected in this potential, charged-up over a period of time. "Shortcut" of this giant capacitor—by transmitter failure—can result in a large flash-over discharge of the EG energy into the local earth, producing a massive EG ground wave that can be enormously destructive.

Thus one must carefully protect the TR wave weapon system from inadvertent discharge of large EG pulses into the earth at the local site, due to transmitter failure, shortouts, etc. Otherwise one's own nuclear weapons or facilities may be exploded—even at some distance—by the EG pulse ground wave produced. One's communications and electronics installations, for example, can be knocked out at an even greater distance.

For example, in the winter of 1957-58, a large Soviet TR wave prototype weapon at Kyshtym, near the Urals, apparently suffered a catastrophic transmitter failure, discharging a powerful scalar EM (electrogravitational, or EG) pulse into the earth. This huge EG pulse struck the atomic wastes stored nearby, causing the radioactive nuclei to immediately decay. In other words, the nearby atomic wastes exploded—just as eyewitnesses reported. Deadly radioactive contamination spread across a major region, and exists to this day.

After this accident, the Soviets would have developed much more elaborate safety circuits and devices and implemented them into their TR wave weapons.

Even so, in April 1986, the explosive eruption of a reactor at Chernobyl was almost certainly caused by an accidental catastrophic failure of a large TR woodpecker transmitter about 30 kilometers away. The sudden failure of the East-to-West Woodpecker transmitter was positively detected by engineer Bill Bise. All safety circuits at the site would have been instantly activated, desperately and slowly draining off the huge "standing wave" potential built up by the weapon.

The Soviets would have immediately shut down the reactors at Chernobyl as a precaution.

Some hours later, the transmitter safety devices finally failed, and a much smaller, though still significant, remnant EG pulse was discharged into the earth, spreading out in a ground wave. The first radioactive material—the fuel rods in one of the hapless, shutdown Chernobyl reactors—encountered by the EG ground wave pulse received it and immediately erupted radioactively.

Had the full EG pulse escaped the stricken transmitter, all four reactors at Chernobyl would have violently exploded, and deadly nuclear fallout would have rained down over a wide area of the earth. Had the reactors not been shut down and the control rods inserted "full-in" to dampen the radioactivity, a far greater radioactive eruption—probably a nuclear explosion—of the struck reactor would have occurred.

In May 1960, a prototype TR wave radar weapon was used to down Gary Powers'

high-flying U-2 aircraft over the Soviet Union. Powers reported a flash, as if from an explosion near him, but the flash persisted. This is almost certainly the signature of a TR wave weapon.

In April 1963, the first large strategic Soviet TR wave weapons became operational. These weapons were used to electromagnetically deaden the electrical controls of the *U.S.S. Thresher* atomic submarine on April 10, 1963, and to produce a huge underwater electromagnetic blast 100 miles north of Puerto Rico on April 11, 1963.

Since the 1960's, the Soviets have possessed a 100% effective defense against U.S. and European strategic bombers and missiles. The early systems deployed in the Soviet Union were midcourse and terminal phase systems. The Soviets would also have relied upon additional TR wave weapons systems, deployed as adjuncts to radar systems aboard research ships and crawlers, to be able to attack U.S. missiles and bombers in their launch and early midcourse phases.

These Soviet defensive TR wave systems also could easily accomplish nuclear weapon kill, and by their nature may have already been immune to the Stealth technology.

Older Soviet radars, using TR wave adjuncts, become totally new weapons having startling and heretofore unsuspected capabilities against missiles and aircraft. For that reason, the Soviets happily continue to operate and maintain thousands of older radar systems that, by Western radar standards, are seemingly obsolete.

Hundreds of incidents of Soviet tests of these TR wave weapon systems have been observed around the world, and reported in the open literature as puzzling or anomalous phenomena.

In the 1960's, in Siberia, Vlail Kaznacheyev and his researchers accomplished enormous experimentation proving that cellular death and disease—of any type whatsoever—could be transmitted and induced electromagnetically. This team went on secretly to phase conjugate (time reverse) the "death photon" signals, to show that any cellular death and disease can be reversed or "cured" electromagnetically as well.

The latter work would have been done under the auspices and tight control of the Soviet KGB, since all phase conjugation (time reversal) weapons effects are under the KGB, both for development and deployment. Obviously the "electromagnetic antidote" work of Kaznacheyev was not published, because it provided a powerful counter-BW warfare capability of great strategic importance to the Soviet Union.

Thus in the late 1960's, the Soviet Union became the only nation on earth to achieve the capability of rapidly (within one or two hours) developing an electromagnetic antidote for lethal new biological warfare (BW) viruses—of any kind whatsoever. The Soviets also developed the capability for mass treatment in this fashion of both the civil populace and the military forces personnel.

Independent verification of the Kaznacheyev "death photons" effect has been accomplished in West Germany (University of Marburg), in Australia (University of Sydney), and in the United States (by G. Wilbanks).

Independent proof of electromagnetic healing of viral diseases was also accomplished in the West, and largely ignored.

In the late 1960's and early 1970's, a French inventor—Antoine Priore—built and tested several large electromagnetic devices that cured thousands of cases of terminal cancers and leukemias in laboratory animals. He worked with members of the pres-

tigious French Academy of Sciences. His work was funded by the French government and presented to the French Academy by Robert Courrier, head of the Biology Section. His work was suppressed in the 1970's, and lost when he died.

Priore used a plasma to accomplish multi-wave mixing and phase conjugation (time reversal). His time-reversed curative signals used a powerful, rippling magnetic field as a carrier; the magnetic field guaranteed penetration of every cell in the body—necessary to reach a blood disease. The rippling of the magnetic field guaranteed penetration of the cell's atomic nuclei by nuclear magnetic resonance. Penetration of the actual nuclei of the atoms in the diseased cell is necessary, since the master cellular control system (discovered by Dr. Fritz Albert Popp of West Germany) operates through the cell's structured scalar EM biopotential, and this potential is centered in the nuclei of the atoms comprising the cell.

Note that electrical dedifferentiation of cells at miniscule current—between picoamperes and nanoamperes—has been proven by Robert Becker and other researchers. Red cells of the frog, for example, have been electrically reversed through all their development stages. The cells first become round, then develop a scalloped outline in their membranes. Then they become ameboid and move by means of pseudopods. Their nuclei swell and their DNA becomes reactivated. They then rid themselves of all their hemoglobin and develop a full set of mitochondria and ribosomes. In Becker's historic experiments, the cells then turned into cartilage-forming cells, and finally into bone-forming cells. In short, Becker demonstrated dedifferentiation followed by redifferentiation into an unrelated cell type—all electrically initiated with laughably weak currents.

Thus profound cellular changes are most certainly inducible and controllable electromagnetically, by miniscule amounts of potentials and currents. Priore's machine applied time-reversed EM waves to accomplish reversal from cancerous cells back to normal cells.

Priore's work essentially proved that Kaznachejev's group would have been able to accomplish the same thing by phase conjugation.

Kaznachejev's "death photons" work was probably accomplished much earlier than reported in the open literature. Thus it probably provided a basis to use in the microwave radiation of the U.S. Embassy in Moscow, to engender blood changes and disease in targeted personnel. Two U.S. ambassadors died from a leukemia-like disease, and a third sickened and bled from the ears and nose. Only miniscule levels of EM signals would have been necessary to induce such biological conditions.

The present Woodpecker radars probably have the capability of producing similar conditions in distant target populations, whenever the Soviets wish to add the appropriate signals. They also probably are capable of killing large numbers of the targeted population, whenever appropriate Kaznachejev "death signals" are placed upon them.

In the late 1960's, another cautious Soviet "intelligence probe" was used: A paper appeared in the open Soviet literature, dealing with time-reversed waves in the field of nonlinear optics. Only a few American optical scientists seemed to be interested.

In 1972, to focus more U.S. attention on their subtle "intelligence probe" of U.S. time-reversed wave knowledge, the Soviets sent two scientists to Los Alamos to brief American scientists on optical phase conjugation. Thereafter many U.S. optical scientists began to work in the "new field." Immediately it was revealed to the Soviet Union

that the U.S. had ineffective knowledge of phase conjugation, and that the U.S. had no TR wave technology or weapons.

To this day, U.S. theoretical work in phase conjugation is still characterized by a fairly simple overall math model, obtained by simply "writing down" the necessary conjugate term. There appears to be absolutely no U.S. awareness of the actual physical electrogravitational mechanism that causes the phase conjugation/time reversal, and no theory of it as such. Its direct application to radars appears to have largely been ignored in the U.S.

In 1975, the Soviets attempted to obtain a treaty with the rest of the world, outlawing the development of frightful new weapons of mass destruction—"more frightful than the mind of man had ever imagined", according to Brezhnev himself. Gromyko introduced the draft treaty into the 1975 session of the United Nations General Assembly. No one knew what the Soviets were referring to.

Failing to obtain the treaty, the Soviets in 1975-76 embarked on the greatest military buildup in history. This buildup was nothing short of a full-fledged preparation to be ready to take over the world, beginning in 1985 (the "ready" time per Brezhnev's 1972 statement at a secret Prague meeting of European Communist Party leaders). The Soviets met this scheduled goal.

As we stated, The Soviets can be immune to any kind of viral biological warfare, anytime they choose to be. The use of lethal new viruses thus has become a highly favored, low-risk method of warfare for the Soviet Union. The West has no such capability against viral warfare, and in fact is totally vulnerable to attack in this manner. Both Western troops and Western civil populations are totally defenseless against the threat of viral biological attack.

A BW strike from a small, hostile nation or from a few radical terrorists—or even an inadvertent contaminant spillage from one of the great many ill-controlled private genetic experiments—can result in the introduction of a lethal, highly infectious new virus that will decimate the West. Indeed, a deliberate BW viral attack upon us may already have been unleashed.

In 1971, the U.S. passed the National Cancer Act and declared open warfare on cancer. Iron Curtain country scientists were invited to participate, and they did so with alacrity. At the time—ironically—penetration of our recombinant DNA genetics research was one of the highest priorities of the Soviet KGB. Obviously, many KGB scientists/agents were infiltrated into our labs under this program (some of our cancer research labs at Ft. Dietrich, for example, still employ more Communist than American scientists.).

In these cancer labs, animal viruses were repeatedly injected and reinjected into human cell cultures, until new viral strains emerged that preferred human cells. These viruses could then be cultured and the effects (or lack of effects) of various chemicals and drugs against them could be ascertained.

These new viruses are exactly what one would wish to develop if one were seeking a biological warfare virus to which humans were not resistant, and one which preferred humans as its host

Sometime during the early 1970's, KGB agents who had infiltrated U.S. cancer research laboratories may have deliberately contaminated the World Health Organization's smallpox vaccine with one or more of the lethal new viruses available in the

Western cancer laboratories. Massive WHO smallpox vaccination in Africa and other Third World countries then resulted in the appearance and spread of the AIDS disease.

If this thesis is true, then AIDS constitutes the first Soviet biological warfare strike against the West, in what can only be categorized as the opening round in a unique new World War III.

With the Kaznacheyev techniques, the Soviet KGB already has the effective electromagnetic antidote against AIDS and other lethal viruses, anytime it wishes to employ it. Some Soviet citizens, however, will be allowed to die, to serve as a deception plan and conceal the true Russian capability. Meanwhile, the Third World nations and the West will be devastated by the killer disease.

Other lethal viruses are almost certain to follow, whether from the Soviets, fanatical terrorist groups, or inadvertent private contamination. Undoubtedly, some of these frightful new viruses are not going to be slow (lentivirus) agents. Some will likely be highly infectious and quick-acting, in the manner of influenza. Some will be transmitted successfully by insect vectors such as the voracious new Asian Tiger mosquito now spreading across the Southeast U.S.

Beginning in July 1976, powerful new Soviet "over-the-horizon radars" (the infamous Woodpeckers) became operational. Extensive weather engineering over the U.S. has been accomplished by these weapon systems. (This has been separately documented by the present author; C. B. Baker, editor of *Youth Action News*; Andrew Michrowski of Canada's Planetary Association for Clean Energy (PACE); and other researchers such as Andrija Puharich.) In addition, the Woodpeckers possess the full range of TR wave weapon capabilities, including real-time holography capabilities and anti-Stealth capabilities. Terrible anti-biological capabilities are also possessed by these weapon systems, and they are also highly effective as global launch phase and midcourse phase defensive weapons for use against U.S. missiles and bombers.

In 1985, the Soviets completed "wet run" weapon tests against U.S. missiles and aircraft and at least three of NASA's shuttle launches, employing the Woodpeckers in the launch phase ABM/anti-bomber mode.

Beginning in December 1985, actual destruction of selected U.S. missiles and aircraft was accomplished. Targets destroyed by the Soviets included the Arrow DC-8 at Gander AFB, Newfoundland on Dec. 12, 1985; the shuttle Challenger launched on Jan. 28, 1986; the Titan 34-D rocket launched on Apr. 18, 1986; a U.S. Delta rocket launched on May 3, 1986; and the French Ariane rocket launched in late May, 1986.

In 1986 and 1987, the mysterious loss of two highly classified U.S. aircraft—believed to be Stealth fighters—may also have been due to Soviet testing of TR weapon capabilities and anti-Stealth capabilities of the Soviet Woodpecker weapon systems.

However, a severe limitation on the unrestricted use of TR weapons exists. If powerfully and unrestrainedly used, they will cause nuclear warheads and nuclear material to explode as surface nuclear bursts—in the dirtiest possible fashion. The resulting massive radioactive fallout would probably wipe out all higher forms of life on earth. Note that Khrushchev stated in 1960 that these fantastic weapons could "wipe out all life on earth if unrestrainedly used."

As long as we possess an appreciable deployment and stockpile of nuclear



weapons, we are essentially "dead man fuzed" against substantial Soviet usage of their powerful TR wave weapons.

Thus Gorbachev needs to "thin out" the deployed and stored Western nuclear warheads, to allow a more unrestrained field of play for his decisive TR wave weapons. That is why at Reykjavik he suddenly expressed full interest in President Reagan's zero option, even expressing agreement with the principle of on-site inspection to insure dismantling of missiles and removal of warheads.

That is also why the Russians are so actively interested in negotiating the withdrawal of nuclear weapons from Europe. They can quickly and easily take Europe, the moment the nuclear weapons are thinned out and our "dead man fuzing" is removed!

To appreciate the ease with which a Soviet offensive, augmented with unrestrained TR wave weapons, can take Europe, consider this: A single airborne Soviet standoff radar jammer, complete with adjunct TR, within minutes can knock out all U.S., British, and FRG radars that illuminate it. Each pulse it fires, destroys an Allied radar. A single Soviet standoff communications jammer, complete with adjunct TR, within minutes can knock out all U.S., British, and FRG communications centers that are transmitting within its detection range. Each pulse that it fires destroys an Allied communications center. A single standoff Soviet jammer-based TR wave weapon can destroy an Allied carrier task force. Pulse after pulse from that weapon system will destroy the task force's radars and communications, explode HE propellants and nuclear weapons, explode fuel, ignite flammable materials, explode rockets and ammunition, and kill personnel wholesale. Tactical adjunct TR weapons can rapidly destroy aircraft, missiles, radars, radios, personnel, tanks, weapon carriers, personnel carriers, ammunition dumps, gasoline dumps, etc. The instant vulnerability of any massive emitter such as AWACS is readily seen.

We are referring to a new kind of blitzkrieg war: War conducted by powerful beams and destruction, engendered at the speed of light War in which electromagnetic radiators are the primary decisive weapons. War in which new kinds of directed energy weapons play the major role. War which renders all our present defensive armada of weapons archaic and useless. War in which the materiel and personnel loss rates are so incredibly high that they boggle the mind of the more conventional military tactician and planner. War in which even a small nation with TR wave weapons can strike and devastate a major power, and possess a first-strike capability unparalleled in human history. War which could be triggered by radical splinter groups and terrorists groups that acquire the technology. War in which the slightest miscalculation or the misuse of the weaponry can completely destroy the earth. War which places extreme emphasis on finding "other ways"—such as surreptitious biological strikes and insidious electropsychological attack and control—to decimate a foe. War that Western governments, populaces, and Armed Forces are completely unprepared—militarily and psychologically—to face.

NATO can be defeated in two hours or less, and the entire war—mop up and all—would last perhaps three days.

Of course, powerful demonstrations of Soviet strategic superweapons could be provided, to show that attempted nuclear retaliation would simply be suicide. The Woodpecker weapon systems alone could wipe out all major communications systems and power systems in the U.S., induce waves of EM-induced death and disease in

preannounced locations, induce waves of abject fear and panic in the populace, or psychologically disrupt and disable—say—the entire Washington D.C. area, to include the people, the government, and the Pentagon.

If such a scenario were accompanied by a proclamation of a Soviet equivalent to the "Monroe Doctrine"—except applying it in Europe, an offer of a ceasefire, and an offer to allow us a "Dunkirk" to evacuate the beaten remnants of our European forces, we would almost certainly be forced to accept the Soviet terms for a ceasefire that left the U.S. intact.

The U.S. Congress—reacting with alacrity to accept this sudden and apparently miraculous Soviet leniency, and avoid the destruction of the world—would probably play the leading role in dictating our acceptance of liberal Soviet terms.

An agreement with the Soviets to mutually withdraw many of the nuclear missiles from Europe appears to be imminent. When the missiles are thinned out, the preceding scenario or some variant of it is almost certain to occur.

There remains, however, one fly in the Soviet ointment: The U.S. Strategic Defense Initiative.

Presently our scientists apply phase conjugation primarily to "keep laser energy beams intact for greater distances." They appear to be completely unaware of the electrogravitational aspects of phase conjugation.

A colleague of the author has already rigorously proven this electrogravitational aspect on the laboratory bench. The phase conjugate (time reversed) wave is composed of, and carries, negative energy and negative time. If an object is forced to produce a great deal of this negative energy/negative time, it produces antigravity. This is because, in negative time, gravity is a repulsion, not an attraction.

In addition, if the electromagnetic energy of a laser is changed into gravitational energy, a theoretical gain of up to  $10^{36}$  (protons) to  $10^{42}$  (electrons) is achievable. In practical devices, an energy gain of  $10^{20}$  may readily be achieved. Applied to a modified powerful laser in space, this electrogravitational gain factor is of overwhelming significance.

In SDI, U.S. scientists presently envision a high energy laser in orbit, pumped perhaps by means of a nuclear explosion. The pulsed beam from this laser would have sufficient power to destroy a rising Soviet strategic ICBM in the launch phase, say at 10,000 miles away.

If that same laser were converted to a scalar electromagnetics laser (one that turns much of its electromagnetic energy into gravitational energy), it could blast and destroy possibly a quarter of Russia with a single shot.

Thus if we developed and tested the SDI spatial/launch hardware for the space-based high energy laser, so that these systems were available for immediate launching, we could convert their lasers to scalar EM and still possess a very real strategic retaliation capability, even if the Soviets should strike us almost unrestrainedly with powerful TR wave weapons. If we launched several of these systems, we could still probably get off a few shots at Russia and destroy her, before all our space lasers could be destroyed by Soviet counterweapons.

In that case, mutual assured destruction would still exist, and we would still possess a full "last ditch" strategic retaliation capability.

Gennadi Gerasimov, Soviet Foreign Minister spokesman, confirmed as much on

the Peter Jennings' ABC News Show, Los Angeles, California on 13 October, 1986. The real concern (with SDI), he indicated, is not with its present design. Instead, the Soviet concern is that the U.S. would make a great technical breakthrough and deploy new devices in space as a modification to SDI, presenting an unacceptable threat to the Soviet Union.

Gerasimov was almost certainly referring to the potential for U.S. adaptation of the SDI space-based lasers to electrogravitational lasers capable of destroying the Soviet Union.

Obviously, if the high energy laser weapons stay grounded in the laboratories, and the system hardware is not developed and ready, that strategic retaliation capability is lost to us. For that reason, Gorbachev is adamantly insisting that the SDI defense must not be developed and tested in space.

If Gorbachev can prevent the development and testing of the SDI space-based high energy laser and get the nuclear weapons thinned out, he immediately holds the decisive winning hand.

This is where we are now, vis a vis the Soviets. This is the background necessary to understand the full context of the present jousting between the Soviet Union and the U.S.

In the *Washington Times* of Aug. 26, 1986, Soviet Chief of Staff Sergei Akhromeyev warned the United States that the Soviet Union could have an unpleasant surprise response if the U.S. deploys its Strategic Defense Initiative (SDI) in space. Akhromeyev stated:

"If the United States deploys a shield in space, the Soviet Union will have several options, none of what Washington would wish... The Soviet Union will very quickly find a response of which the United States has no inkling as yet."

It is absolutely essential that the President of the United States, the Secretary of Defense, the Joint Chiefs of Staff, and the U.S. Congress be aware of these Soviet weapons and their capabilities.

It is also essential that the U.S. public become aware of the real nature of the hidden Soviet threat that faces us, so that public support will be forthcoming for the hard decisions our government leaders have to make to counter it.

# A PARTIAL GLOSSARY FOR SCALAR ELECTROMAGNETICS AND SUBTLE PHENOMENA

by Tom Bearden

1. **Action:** the fundamental constituent of physical reality. Basically composed of two quantities—energy times time, momentum times length, etc. Action is nonobservable; only changes in action are observed, and then only partially (in the linear case). The photon is the basic quantum of action, consisting of a piece of energy welded to a piece of time, with no seam in the middle, so to speak. All physical things are composed of rates of changes in action. The physicality (volume characteristics) of space are created bit by bit from action quantum changes in and on each fundamental particle of mass, at a very high rate of speed. These action changes are totally internal to the mass itself. Therefore, literally the physical universe exists inside each and every part of itself, and is a giant hologram.

2. **A-field:** vector magnetic potential. The A-field is a real field—not a mathematical convenience as was originally thought—as detailed in the second volume of Feynman's three volumes of physics. Indeed, it may be separated from the magnetic field, as the experiment reported by Feynman details. When separated, it is often referred to as the "curl-free vector potential."

3. **Aharonov, Yakir:** renowned Israeli quantum physicist and former student of David Bohm. Together with Bohm, Aharonov authored a fundamental paper in 1959 which pointed out the primary importance of the potential rather than the force field. Co-discoverer of the Aharonov-Bohm effect: Even when the electromagnetic force fields reduce to zero in a charged particle system, the potentials may still exist and interfere to cause real physical effects.

4. **Aharonov-Bohm Effect:** Effect whereby interfering electromagnetic potentials can produce effects on charged particle systems, even at a distance and in the absence of the electromagnetic force fields. When E and B fields are zero in a region, their potentials still exist and interference of the potentials produces real electromagnetic effects (energy) in the interference zone, even at a great distance, without transmission of "energy" per se through the intervening space. The Aharonov-Bohm effect highlights some of the stark differences between the classical view of electromagnetics and the quantum mechanics view. In classical EM, the force fields are the real causative agents while the potentials are only mathematical creations for convenience in calculation. In quantum mechanics, it is the potentials that are real and fundamental; the force fields are effects derived from the potentials by differential operators. In classical EM, when the E and B fields are zero in an area, there is no more electromagnetics going on there; in quantum mechanics, the potentials still exist and may still cause real effects. By the use of artificial potentials, the Aharonov-Bohm effect can be made macroscopic and used to cause action at a distance—even significant action at a very great distance. Thus scalar EM interferometers can produce energy effects at a distance. The negative Aharonov-Bohm effect also exists. If the potentials of the transmitters in a scalar interferometer are biased highly negatively, then energy is extracted from the dis-

tant interference zone, reappearing at the transmitters. Tesla proposed a "Big Eye" that could see at a distance; actually he planned to use a negatively biased scalar interferometer, scan the beams, then reassemble the scanned energy appearing back at the transmitter/receivers. In this way he had a crude picture of the distant conditions in the interference zone. Such a device can see through the earth or ocean to a preselected intersection depth, since scalar EM waves can be made to pass readily through the earth or sea. The Aharonov-Bohm effect is in fact experimental proof of the new definition of force used in scalar electromagnetics. That is, force consists of mass in motion changing its motion (momentum). The nonzero  $\theta$  created by interference of two electrostatic potentials at a distance, for example, will create an electric field (E-field) on and of an electrically charged particle there. The standard detection of an E-field by conduction electron detectors is an example. It is the electron gas particles (charged electrons) that are detected, not what is in the vacuum. Thus classical EM errs when it assigns the equation  $E = -\theta$  to vacuum, for no such thing is ever measured. Actually, the correct equation is  $E = -\theta(e)$ , where means "coupled to" and  $(e)$  means "electrically charged particle."

5. **Aikido:** a Japanese martial art whose modern form is a synthesis of many schools of jujitsu and the zen art of meditation in motion. The advanced aikido practitioner seeks to attain a state of "nomindedness," in which there is no separation of subject and object, of attacker and defender, or even of past and future. This state of at-oneness with the universe, when attained, results in the complete mastery of the art. It is rarely experienced, even occasionally, and even rarer is it permanently attained. One who attains this state permanently is considered a great master, and his demeanor and personality are profoundly altered. The deceased founder of the present modern form, Morihei Ueshiba, attained such mastery of the art. He was a serene, deeply religious man and a profound inspiration to several generations of martial artists. He was also unbeatable even in his eighties.

6. **Anenergy:** stress energy of vacuum. "Fragments" of energy, more subtle than electromagnetic energy, turned against themselves and locked into a "vector zero summation." Scalar, massless charge flux. Virtual particle flux. "Pieces" of the spatiotemporal vacuum spacetime medium (i.e., qutons). Specifically, an observable object rotated more than one orthogonal turn away from the laboratory frame constitutes an anenergy particle. Examples are the virtual photon (rotation between 90 and 180 degrees), the bare neutrino (rotation exactly 180 degrees), the virtual bare neutrino (rotation between 180 and 270 degrees), and the thought or mind particle (rotation 270 degrees or more). Also, more fundamental components of energy—specifically, the individual scalar wave components of vector electromagnetic waves. Anenergy components may be coupled into energy, which can be compacted into mass. The conservation of energy law is replaced with a more fundamental law, the conservation of anenergy. Anenergy contains two com-

ponents or constituents: (1) ordinary energy (positive time, positive energy), and (2) phase conjugate energy (negative time, negative energy).

7. Angular momentum: the momentum or "leverage" of the momentum of a moving body, with respect to an axis or reference point Has the same units as action, or energy x time, or momentum x length.

8. Antimatter: matter consisting of atoms which are composed of positrons, antiprotons, and antineutrons. Also loosely refers to the antiparticle corresponding to a particle—the antiparticle may be regarded as the particle traveling backward in time, or "phase conjugated." In present physics, the photon is recognized as its own antiparticle. However, since physicists do not differentiate between positive and negative energies in a photon, then they assume that there is no difference between a photon and an antiphoton. The antiphoton, however, acts quite differently from the photon, as is clearly shown in phase conjugation. The magic rule of scalar electromagnetics for the final photon emission interaction with a charged particle in an atom is this: In the expression CPTEGS (where C is charge and normally negative, P is normal parity, T is time and normally positive, E is energy and normally positive, G is gravity and normal is positive, S is entropy and normally positive or increasing), if one of the components is reversed in sign, then each of the remaining components is also individually reversed in sign. The phase conjugate photon (antiphoton: negative energy, negative time), e.g., is produced by the photon interaction with the positively charged nucleus, producing a time-reversed wave having negative energy, negative time, reversed parity, causing gravitational repulsion, and causing negentropy.

9. Antiparticle: a counterpart to an ordinary fundamental particle, having identical mass lifetime and spin, but with charge and magnetic moment reversed in algebraic sign. Note that when the charge is reversed, parity and time are also reversed. Thus, properly, the antiparticle is the phase conjugation of the particle, or just conjugate particle for short.

10. Artificial potential: potential formed by deliberately summing force field vectors to a zero vector resultant This vector zero has a deterministic, internal stress pattern that is macroscopic. The type of potential made by the zero summation depends upon the type of force vectors summed. For example, summing electric field vectors to zero produces an electrostatic scalar potential; summing magnetic field vectors to zero produces a magnetostatic scalar potential of vacuum. All such potentials represents local warps or curvatures in vacuum/spacetime. Since Einstein assumed that spacetime locally was uncurved, this violates one of the assumptions of Einstein's general relativity. The Soviets have long made this correction; Western physicists have not Since curvature of spacetime is gravitational, this constitutes the secret of electrogravitation: How to turn electromagnetics into gravitation, and vice versa. I have called this "scalar electromagnetics"; the Soviets refer to it as "energetics." In such a vector zero, the locked-in energies of all the component force vectors constitute the "anenergy" of the artificial potential. Potential in vacuum is analogous to "pressure" in fluids. An artificial potential polarizes the vacuum and constitutes a specific stress pattern in it Thus vector-zero summed systems of

individually finite vector components may all differ from each other.

11. Ball lightning: rare form of lightning where an incandescent, slow-moving globe forms. The globe often moves erratically, explodes, and may set fire to objects it touches. Ball lightning is due to scalar electromagnetic interferometry which can produce a controlled pattern of electromagnetic energy at a distance. Phase conjugation is directly involved; note that the literature already explicitly demonstrates that phase conjugation can perform real-time holography, or produce forms of energy at a distance.

12. Bare electron: in physics, the true electron without the partial shielding of virtual positrons that are attracted around it In scalar electromagnetics, the mass of the electron, considered without its flux of virtual photons (its massless charge flux). An electron mass without its charge (in new approach); that is, one that is really bare of all charge!

13. Bare neutrino: the photon rotated one orthogonal turn farther away from the laboratory frame would be seen in the laboratory frame as a bare neutrino. In the new approach, bare neutrinos move at the speed  $c$  inside an ordinary photon, orthogonal to the photon's direction of travel, constituting a flux in each half of the photon. Two neutrinos move in the photon, one in each half (a simple photon is a single sine wave). One neutrino moves in positive time, the second moves in negative time and is properly an antineutrino. Since the photon moves at the speed  $c$  with respect to the laboratory frame, then the bare neutrino moves at the speed  $c$ -squared, but only its carrier speed  $c$  is seen by the laboratory observer. The flux of bare neutrinos in each half of a photon corresponds to the classical neutrino of present physics. The bare neutrino is (to the lab frame) a factor of  $c$  smaller than a photon, and one dimensional. It is a special kind of polarization wave to the lab observer.

14. Bearden, Thomas E.: nuclear engineer, retired Lieutenant Colonel (U.S. Army), and theoretical conceptualist active in the study of paranormal phenomena, scalar electromagnetics, Soviet Tesla (time-reversed wave) phenomena, free energy, antigravity, electromagnetic healing, and human development. Particularly known for his work in scalar electromagnetics and Soviet unorthodox weaponry.

15. Beck, Robert: noted psychotronics and ELF researcher who has pioneered many unusual measurement fields such as the Schumann resonance of the earth's magnetic field, specific effects on humans of extra low frequency (ELF) signals of precise waveform and frequency, ELF pollution effects, and brain wave entrainment by weak ELF signals of precisely controlled frequency. He is also noted for his development of a series of very sensitive detectors and scalar wave detectors.

16. Bedini, John: noted audio engineer, creator of the renowned Bedini amplifiers well known to audiophiles, and researcher into free energy, antigravity, and electromagnetic healing. Bedini has built several free energy motors and devices, including a gravitational field generator, a gravitational field turbine, and a series of monopole motors. He is also noted for his development of sensitive scalar EM wave detectors. He is struggling to develop an electromagnetic phase conjugate signal which will kill the AIDS virus, and also reverse the genetic damage done to the cell by the virus.

17. **B-field:** the magnetic induction  $B$ . This is defined, analogously to  $E$ , by the force it exerts. The force on a point charge moving in a magnetic field is at right angles to the velocity vector of the charge and also at right angles to the magnetic field. Actually, the  $H$ -field was originally named the magnetic field and the  $B$ -field was named the magnetic induction. This is an annoyance because it is  $B$  which produces or involves the force, and hence should be named the field. Other writers have noted this discrepancy, and Sommerfeld called  $H$  the magnetic excitation—which correctly describes its role—rather than die magnetic field. In Kaluza-Klein unified field theory, all electromagnetics is in the 5th dimension, which is wrapped around each and every point in our normal 3-dimensional space.
18. **Being:** pure essence, existence. Again, something which in actuality resists definition unless preliminary assumptions are made. Generally used in one of two senses: (1) persistence, as in "he is (he continually exists)," or (2) identity, as in "he is the man ('he' and 'the man' are the same thing)." Even in the first instance - persistence - one is using the form of the verb "to be" in the sense of identity, when perception is considered; i.e., "he is" is a statement that "he continues to be presented or perceived, because each succeeding perception is identical to the one before." Thus when perception is considered, being may be defined as that which is undifferentiated, and this yields its total definition. This is the real void devoid even of void, if one considers zen.
19. **Bennett Island;** Soviet island on which large, anomalous exhausts—some 150 miles long and nearly horizontal—are repeatedly photographed by U.S. weather satellites. Over 100 incidents have been photographed there since 1974. These exhausts are believed to be the exhausts of energy extracted by distant Soviet scalar interferometers used in the endothermic mode, then switched to the exothermic mode and focused on Bennett Island as a "dump site." Similar exhausts have been seen on Novaya Zemlya, a large island off the north coast of mainland USSR.
20. **Bigfoot:** U.S. slang or common name for a materialized sasquatch or apeman-type tulpoid, even if not well-formed.
21. **Big Mama:** very large, glowing nocturnal light UFO believed sometimes associated with cattle mutilations. Implies a sort of "mother ship" which spews forth smaller ships, which then speed off, swoop down to mutilate cattle, and return. Big Mama has been observed to split into or spew off smaller lights which sped away, dipped down, then returned. Some of these occasions appear to have been associated with cattle mutilations. The most noted photographs of Big Mama were taken by Bill Jackson.
22. **Biofield:** a hyperfield, particularly with reference to the fields of a living biological system. Also bioframe, bioworld, hyperfield, hyperframe, hyperworld, orthofield, orthoframe, orthoworld.
23. **Bioframe:** a hyperframe, particularly with reference to the frame of the body of a living biological system. Also biofield, bioworld, hyperfield, hyperframe, hyperworld, orthofield, orthoframe, orthoworld.
24. **Bioworld:** an orthogonal universe one or more right angle turns away from the ordinary world, particularly with reference to the frame of the body of a living biological system. Hyperworld. Orthoworld. Living energy forms—"critters"—exist in these bioworlds. A bioworld is also one of the netted levels of infolded virtual state. Such "living electricity" can be manipulated and utilized by scalar EM means.
25. **Bohm, David:** world renowned physicist and originator of hidden variable theory. Together with his student Aharonov, he co-authored a fundamental paper on the Aharonov-Bohm effect wherein interfering electromagnetic potentials can produce effects on charged particle systems, even at a distance and in the absence of the electromagnetic force fields.
26. **Brain wave:** a rhythmic fluctuation of the voltage between various parts of the brain, normally ranging from about 1 to 60 Hertz in frequency and 10 to 100 microvolts in potential strength. Brain waves are caused by avalanche discharge firings of the nerve cells in the brain. Actually, classical brain waves are only the residue or "spillage" waves of the brain, and the important activity is in the specific patterning of the vector zero summations of the myriads of ion discharges. Every "discharge ion" constitutes a small EM force vector. The summation of these is largely zeroed; however, the patterns formed by all these tiny components are not random. The intent and will of the human being is expressed in the changes in the patterning of these dynamic substructures. Present EM brain wave theory does not touch the basic "thought patterns," which are scalar in nature. Use of the two cerebral hemispheres as a scalar interferometer provides mechanisms for the effects of parapsychology and paranormal phenomena such as fire walking.
27. **Burst, burst-in:** the sudden collection or condensation of anenergy into a frame, so that observable light or electromagnetic energy (or rarely, physical matter) appears (is kindled). Sudden kindling of anenergy into energy.
28. **Cattle mutilations:** the strange, paranormal, surgical killing and/or mutilating of cattle in the U.S. and other countries, particularly since the 1973 Yom Kippur War. Metapsychologically, mutilation of the cow is the mutilation of the female symbol—that is, it symbolizes mutilation of "Fortress America." Many small animals such as cats, dogs, rabbits, and birds have also been paranormally mutilated, which is destruction of the child symbol. Again, this symbolizes the mutilation of "Fortress America." The author regards such bizarre paranormal incidents as being caused by temporary materializations of the unresolved conflicts from the human collective unconscious's dreams. With this thesis, if knowledge of Soviet scalar electromagnetic weaponry is also included, analysis very similar to standard psychological dream analysis provides explanations consistent with the bizarre mutilations and the Cold War.
29. **Causality:** the time ordering of ordinary inert interactions. Macroscopic (observable) causality may be violated by control of hidden subquantal (virtual state) variables. With scalar electromagnetics, direct engineering of the virtual state—and hence violation of observable causality—in possible.
30. **Cerebral hemisphere:** each half of the cerebrum, the enlarged anterior or upper part of the vertebrate brain. The two cerebral hemispheres may function as a scalar interferometer to sense distant scenes (even distant in time), or produce energy and signals at a distance. The time aspect (e.g., in psychometry) is due to utiliza-

tion of the cerebrum as a phase conjugate mirror (PCM), and inputting tiny signals picked up from the object one is holding. A phase conjugate signal is then originated by the PCM, retracing the route to the original object. Unfortunately the output of the human nervous system that can accomplish such scalar EM functions lies very deep within the unconscious mind, and it is very difficult to raise it to direct consciousness. Usually the conscious mind is only aware of "vague impressions" instead of clear signals, although in the extremely rare instance clear impressions are consciously detected.

31. Changing the past: every intentional inception upon ordinary inert causality represents a slight alteration or change in direction, departing minutely from pure causality. From a causal viewpoint, each human inception minutely changes the causal past, as well as the future.

32. Charge: the repetitive, "locked in" massless virtual particle emission and absorption activity (flux) of and on a fundamental particle such as an electron. Vacuum is identically pure massless charge flux. In the new theory, the intensity of the charge flux on a particle is also directly related to the rate of the particle's passage through time. The continued absorption and emission of photons by a particle provides the general mechanism by which the particle moves along in time in little jumps. In the scalar EM view, the relativistic change of the rate of flow of an object through time is due to a change in its ambient vacuum charge potential—i.e., to a change in the rate at which it is absorbing and emitting virtual particles and scalar waves. The negative charge is associated with a positive time flux (hence with positive energy) and the positive charge with a negative time flux (hence negative energy). A positive charge is also a negative charge moving backward in time. All particles have clouds of virtual activity patterns; essentially all mass is charged since these clouds contain charges. In ordinary electrical physics, charge is defined in terms of force and force in terms of charge, and charge and charged mass are erroneously made synonymous. In scalar EM, a "charged particle" represents a mass (nonlinear bump in spacetime, or "local nonlinearity" medium) that separates the scalar waves of vacuum into two parts, one is normal energy and the other is the phase conjugate having negative energy. It is important to remember that a charged particle is a special sort of high pressure "pump" and "vacuum cleaner" at the same time. So is a "magnetic pole" or a "potential."

33. Cold explosion: the sudden extraction of energy from a distant intersection zone of the crossing beams of a scalar interferometer which transmits in the pulsed mode while negatively biased. A famous example of Soviet testing of a cold explosion scalar EM weapon is the huge cold explosion that occurred off the coast of Japan on April 9, 1984. When the energy is suddenly extracted from a zone near the surface of the ocean and above it, the pressure in the zone is suddenly lowered. Water vapor and mist are violently sucked up, and the surrounding air rushes in, pushing the "water vapor filled region" rapidly upwards. The pattern that results is a rising mushroom cloud, very similar in appearance to a nuclear explosion, except for the absence of a flash and blast wave. In a cold explosion, the energy is extracted from throughout the spacetime of the distant interference region, and insulation has no effect since classical heat

conduction through space is not involved. Ordinary electrostatic cooling is also an example of this effect in less violent form.

34. Consciousness: refers to a living being's awareness of its sensations, feelings, thoughts, and the world around it. Specifically, consciousness involves an anenergy communication channel where detections of the body-object (which may be regarded as a sort of special camera, instrument, or physical tuner) project into the mind as separations from the beingness of the subject. Further, it refers to the intersecting stream of monocular,  $\alpha\epsilon$ —at-a—time virtual projections into the mind from the quantum changes of photon interactions upon the body sensors. By memory (collection in the mind) of streams of such monocular changes one after the other, the entity is conscious of its body-object (camera—tuner) monocularly "moving through time." In the absence of deeper understanding, the individual consciously sees itself as a separated physical object moving and changing in time, i.e., with respect to other separated physical objects that it perceives. The "externality" of certain changes (i.e., the physical world) is due to the lack of mental control or influence over them. "Internality" of certain other changes is due to the ability to mentally control or influence them. The ordinary conscious mind is a serial processor: only one thing at a time is discriminated in its awareness. The unconscious mind, on the other hand, is totally conscious—but multiply so, since it is a parallel processor of many discriminations at once. The conscious mind, then, cannot directly perceive the individual discriminations of the parallel processor, since these appear only as a blur or nothingness to it (much like looking at a hundred 35mm slides in the projector at the same time). This is the mechanism of the barrier between the conscious and unconscious minds. Projections from the unconscious onto the screen of the conscious mind will thus appear symbolical—that is, having many hidden meanings at once. This is why our dreams, for example, appear to our conscious minds as weird and distorted, but highly symbolic in nature.

35. Contactee: a person who seemingly has had a direct contact—mentally, physically, or both—with aliens, extraterrestrials, etc.

36. Continuous mode: for a scalar interferometer or Tesla howitzer, mode of operation where power is fed continually to the transmitters, and the two Fourier expanded scalar patterns or beams are continuously transmitted. In this mode, in the distant interference zone a glowing pattern of vector electromagnetic energy appears and is sustained. (Note the possibility that a few of the UFO sightings could well be due to the deliberate usage of such a mechanism by the Soviet Union or some other nation possessing the requisite technology to create such physical "apparitions" at a distance.)

37. Corpus callosum: the thick nerve cable that links together the two cerebral hemispheres (which are separate brains) in each vertebrate (including human) brain. In each of the two cerebral hemispheres, there is a separate mind and personality (given that the other is separated). However, a brain has a unique characteristic: Anything that arises directly inside it is automatically assumed to be self-originated, since the brain-tuner can differentiate no separation or "separate source" for the signal/thought arising directly upon its "internal screen". This allows integration of the two brains/minds/personalities into one.

That is, when one brain half prepares and sends a message, that message is also routed across the corpus callosum into the other brain half, arising internally upon the second brain's "display." The second brain half therefore thinks that it itself originated the signal or message. Thus when the left cerebral hemisphere moves the right thumb, for example, the right hemisphere thinks that it itself ordered the movement of the right thumb. Perceptually, the definition of identity is the loss of all distinction."

38. Cotton effect: the wavelength dependence of certain optical and absorption characteristics in a substance in the vicinity of an absorption band. An absorption band is a range of electromagnetic frequencies within which electromagnetic energy is absorbed by a substance. The direction of polarization of the energy affects the degree of absorption for certain substances. In these substances, the frequency and the direction of polarization of incoming electromagnetic energy affect the amount of energy deposited and dispersed.

39. Crawford, Hal: accomplished science fiction artist and illustrator who has furnished many drawings in the new approach and contributed to the theory of mind linkage.

40. Crosstalk: in ordinary science, the transfer of energy or signal from one channel to another, by cross modulation or cross coupling between the channels. In the new approach, it refers to virtual anenergy exchange between orthogonal universes or frames—that is, between different 3- or 4-dimensional slices of an infinite-dimensional universe.

41. Cyborg: (noun) a single integrated system consisting of a living system energetically or functionally linked to mechanical or electromagnetic devices and/or systems. (Verb) link, in the sense of forming such a system. A living biological system is a cyborg of its mindworld (mindframe) to its body (laboratory tuner).

42. Death: the loss of the preferential tuning of a physical body to its mindworld. This causes loss of the preferential consciousness loop or life channel, resulting in "death." Actually the being is unchanging and indestructible, hence consists of all changes and destructions simultaneously, with none separated individually. Life and death thus are two sides of the same coin, and the coin is immutable, regardless of which side is exposed.

43. DeBroglie wave: a matter wave. The quantum mechanics wave associated with a particle of matter, which can give rise to interference effects. An orbital electron in an atom is associated with a standing DeBroglie wave on a Bohr orbit. DeBroglie waves always move faster than the speed of light, the speed being given by  $c^2/v$ , where  $c$  is the velocity of light in vacuum and  $v$  is the velocity of the particle of mass. Debroglie wave velocities thus vary from the speed of light to infinite speed (everywhere at once). In his speech accepting the Nobel Prize, DeBroglie emphasized that, since these waves produce real physical effects, they are real and must not be regarded simply as mathematical conveniences.

44. Dimension: a certain primary geometrical physical attribute, such as length, used to describe the separational relationships of physical phenomena. By "geometrical" we mean that the "dimension" is considered to "exist" in either the presence or absence of the observable physical phenomenon; however, by agreement the dimension itself is not directly observable. It

can be inferred ("measured"), however, by comparative operations of simple devices such as clocks and metersticks, and its simplistic definition is usually given as "that which has measurable magnitude." Prescribed measuring procedures are used to assign magnitudes to these inferred dimensions, using specific scales. Actually, "dimension" just means "fundamental quantity of separation" in the most general sense. The number of dimensions taken in advanced physics usually represents a somewhat arbitrary choice for good modeling fit. In modern Kaluza-Klein theory, for example, it becomes necessary to accept some 10 or 11 dimensions.

45. Dirac sea: in Dirac electron theory, the relativistic wave equation for the electron has four components, which correspond to two spin orientations and two energy conditions: positive and negative. Thus the vacuum possesses a "sea" of negative energy conditions for electrons. These are called "holes" and are considered to ordinarily be filled with electrons which have fallen into these negative energy states. The Dirac sea thus is this vacuum sea of negative energy electrons. If energy is added, electrons can be lifted from this sea. If spacetime is locally curved, additional holes may be created so that normal positive energy electrons fall in and disappear, creating the appearance of an "electrical energy sink." If the curvature is in the opposite direction, electrons may be lifted from the Dirac sea by the curvature, thus producing a flow of electrons and creating the appearance of an "electrical energy source." In several battery-powered free energy motor devices where the battery is sharply "back-spiked" for recharging, the battery has been noted to apparently accumulate such additional "Dirac holes" as the DC series-wound motor ran. When later recharging the battery with a normal charger, for example, the battery would first "consume" a quantity of electricity to "refill the holes." When the holes were filled with new electrons, the battery would then start to recharge normally. In one extensively used battery, Watson noted that it consumed electricity for some eight hours before recharging normally. Similar effects have been noted by Bedini.

46. Dissociation: separation of ideas from their affects or feelings, resulting in independent functioning of these components of a person's mental processes. Simply put, fragmentation of the mind and personality. In this sense, Zarg (the collective human unconscious mind) is severely dissociated, since its "conscious mind" is fragmented into billions of pieces (into the independent conscious minds of ordinary humans). This is severe dissociation and psychosis; Zarg (the human species) is quite literally insane.

47. Dowsing: use of handheld rods, forked twigs, pendulums, bent coathangers, or other simple physical detectors to locate water, minerals, lost objects etc. or to seek answers to specific questions. The movement of the physical instrument serves as an indicator and is cyborged to the dowser mentally and psychokinetically.

48. E-field: the electric field or electric intensity  $E$ . That field on a spinning charged mass which produces an electrical force, hence linear motion of the charge. (In the new theory, the E-field CONSISTS OF the spinning charged mass, moving through a finite change in electrostatic scalar potential, and thus there is a more fundamental generatrix of FORCE.) Defined as the force per unit charge (i.e., per unit of charged mass). On a free



electron, there may exist two separate E-fields, one in the direction of motion of the electron (normally due to voltage); and one at right angles to the electron's motion, due to the time derivative of the A-field.

49. Einstein's postulates: (1) all the laws of physics are equally valid in all inertial frames of reference, (2) the speed of light is the same to every inertial observer, and (3) the observable local effects of a gravitational field are indistinguishable from those arising from acceleration of the frame of reference. The first is called the special relativity principle, the second is called the law of light propagation, and the third is called the equivalence principle. It is now known that postulates (1) and (2) are not independent of each other. Note that the third postulate implies that any local force is due to a "gravitational field" (acceleration of the frame of reference). It also implies that gravitational force has a mechanism, since quantum mechanics assigns a differential operator, operating upon a potential, to create every force. By extended inference, it can be seen that the third postulate also implies that there should exist a method to turn any type of force (field) into gravitational force (field).

50. Electrogravitics: electrogravitation, or scalar electromagnetics (SEM). The term "scalar electromagnetics" was chosen by Bearden to describe the electromagnetics that goes on inside a macroscopically summed-zero force vector system, producing gravitational effects and energy effects at a distance. A priori, SEM is a unified field theory, which predicts strong effects easily verified experimentally. The struggling science that seeks to produce gravity and inertial effects electromagnetically (success has been achieved recently in proprietary labs). Santilly has shown that the classical assumption that electrical field and gravitational fields are mutually exclusive is false. They are therefore either the same thing or partially the same thing. There are numerous anomalous experiments which also show a connection between electrical effects and gravitational and inertial effects. Appreciable technical work in the U.S. seems to have been done on electrogravitics in the 50's and 60's, much of it apparently classified. There are presently strong electrogravitic efforts in Germany, France, and Japan. Scalar electromagnetics is in fact electrogravitics (electrogravitation) and has been successful in engineering gravitational devices such as gravitational and inertial field generators, gravitational field motors, free energy generators, and gravitational turbines. Tesla's secret of wireless transmission of energy at a distance without losses has been rediscovered, as has the secret of his "big eye that can see at a distance." A new land of resonance—scalar resonance—has emerged, as has a new kind of wave, the scalar EM or electrogravitational wave. Scalar wave detectors are now becoming available due to the pioneering work of Dea, Beck, Bedini, and Golden, who have all built scalar wave detectors. A substantial series of devices have been built by Bedini, Golden, Watson, and other inventors who wish anonymity. One of the very first good experimental physicists who built electrogravitational devices was Hooper. Actually, Maxwell's original quaternion theory, published in 1864, was the correct unified theory of gravitation and electromagnetics. After Maxwell's death, Heaviside "translated" (mutilated) Maxwell's theory into his new vector mathematics, discarding the quaternion's scalar component. He

thus discarded electrogravitation, setting "modern EM theory" upon its nongravitational course.

51. Electron dissolution: when the virtual photon activity of an electron (i.e., its charge) is directly quenched, the electron is converted to a neutrino or neutronic wave, which radiates away without interacting with materials or objects. In this case, no ordinary photons are radiated. Orbital electrons in atoms are generally protected from this interaction by being locked into their orbital DeBroglie waves. Free electrons flowing in circuits, however, are susceptible to the effect by scalar wave coupling. By this means, electromagnetic circuits may be duded by dissolving their currents, without physical damage to the circuitry components. Whenever the agent causing the electron dissolution is removed, currents resume and the circuits resume normal electrical action. Scalar longitudinal 0-field waves can also be absorbed in scalar coupling into the E-fields of currents flowing in a circuit. This can either augment or diminish the E-fields to which coupling occurs. If the E-fields on the flowing electrons are zeroed, the electrons cease flowing, and the circuit is duded.

52. Electrostatic scalar potential (0): virtual photon stress on the 4-dimensional spacetime medium (on the vacuum-ether). (Note that the vacuum can be regarded as consisting of the sum of a large group of such potentials.) The spatiotemporal intensity of the massless charge (of the virtual photon flux through a spatiotemporal point). Nikola Tesla discovered pure longitudinal scalar 0-waves. Present spatial 0 in the ordinary theory is only a special case. 0 can be visualized as a special type of "pressure" in an n-dimensional fluid, where n is equal to or greater than 4. By omitting the potential's stress on time, present potential theory eliminates the potential's ability to affect everything existing in time (for example gravity, fundamental constants of nature, inertia, mass, rate of time flow, mind, life, etc.) It also eliminates the direct engineering of local general relativity, and the concomitant violation of the conservation laws (momentum, energy-mass, charge, spin, etc.) Present electrical theory—and indeed all of physics—is drastically in error by this serious omission. Direct engineering of artificial potentials by patterned zero-vector force field summations is the secret of the long-sought "unified field theory." It is also the secret of the unification of mind and matter into a single scientific discipline.

53. EMP (electromagnetic pulse): a sharp pulse of electromagnetic radiation produced when an explosion occurs in an unsymmetrical environment, especially at or near the earth's surface or at high altitudes. Essentially the same as an electromagnetic shock wave, a wave of great intensity which results when waves with different intensities propagate with different velocities in a nonlinear optical medium. An EMP is also produced when two intense longitudinal scalar electrostatic potential wave patterns meet and couple into a sudden flash of vector EM energy.

54. Endothermic explosion: the sudden absorption of electromagnetic energy in a spacetime area where the energy converts to a potential, and scalar waves radial back to the negatively biased transmitter/receiver, emerging there as ordinary electromagnetic energy. As implosion. All normal explosions are exothermic in nature, and ordinary electromagnetic heat energy is radiated away. A scalar EM howitzer, however, may pro-

duce an endothermic explosion (an energy implosion) at a distance, explosively extracting the heat energy at the implosion site and receiving the energy back at the transmitter site for disposal.

55. Energy: the capacity to do work. Energy is directly tied to the work concept, which is the result of a force moving through a distance. However, "work" refers to the past; that is, the force has moved through a distance against a resistance. "Energy" refers to the future; the force could in the future move through a distance against a resistance. Since the force is tied in turn to a changing mass motion, it follows that—conceptually—energy is tied directly to mass systems. The "energy" that an object possesses depends also upon the observational situation: a moving observer may see a moving object as possessing more or less energy than the lab observer sees. Electrostatic scalar waves do no work and individually have no "energy" per se. Two different scalar waves coupled onto a spinning charged mass, however, produce a system which has mass and energy, and does work.

56. Ether: originally, a ghostly-thin, material, fluid medium postulated to fill space and carry electromagnetic waves, similar to the way in which a gas carries sound waves. The Michelson-Morley experiments eliminated any such material ether, but not a Lorentz-invariant non-material ether (of which vacuum itself is one example, in the modern view). Maxwell's equations were derived from ether theory. Einstein once proposed that the vacuum, complete with its electromagnetic fields, should be called the ether. Indeed, the word "ether" is again acceptable in the literature in context of its modern meaning. Today the "ether gas" is considered composed of virtual particles—that is, the particles spontaneously come into being and then vanish so quickly they cannot be individually detected. That is, today the ether is a virtual particle gas—sort of a gas of "effervescent bubbles", so to speak. Ives derived special and general relativity, Newton's laws of motion (relativistic form), and the square law of gravitation from a Lorentz-invariant non-material ether theory. Zero-point energy of vacuum would also seem to be a Lorentz-invariant ether. The Soviets are believed to have applied and advanced the Ives theory to produce their present theory of energetics, which is highly classified by the Soviet Union. In the new approach, vacuum is identically pure massless charge (virtual particle flux), and thus an ether as Einstein proposed.

57. Evil: refers to an act theoretically detrimental to the receiver or referent, in the positive time stream. It is equally beneficial to the referent, viewed in the negative time stream.

58. Exo-electron emission: emission of electrons from the surfaces of metals and certain ceramics after these surfaces have been freshly formed by a process such as abrasion or fracture. Cracks in metals are good emitters of exo-electrons, and the electrons can be detected, to provide a means of detecting the minute fatigue or stress cracks. The sides of a crack in a stressed metal constitute a scalar interferometer, and scalar interferometry is involved in the emission process. Exophotons are also emitted, in addition to electrons. In an earth tectonic plate fault zone (crack), stress exists on each side of the plate, but not in the middle, and the fault thus constitutes a scalar interferometer, emitting charges and also often creating glowing balls of light

59. Exothermic explosion: an ordinary explosion where ordinary heat and electromagnetic energy are released and radiate away from the explosive site. All normal explosions are exothermic.

60. Feynman diagram: a two-dimensional diagram of particle interactions, both in the virtual and observable levels, and both backward and forward in time.

61. Fireflies: sentient bits of light that sometimes kindle in the presence of a psychic initiator and/or a psychotronic generator. Literally, minute glowing, indefinite thought forms materialized into electromagnetic energy. This can be understood by modeling thought forms as real electromagnetic forms existing in a rotated universe (i.e., as hyperdimensional). Interference causes dimensional shifting, so that ordinary electromagnetic energy forms can result

62. Firewalking: walking on and across a bed of glowing coals without the feet being burned. Firewalking is demonstrated in a variety of cultures, belief systems, and locations throughout the world. Recently many Americans have been taking to the practice and demonstrating that it is an achievable phenomenon. In the new approach, the two cerebral hemispheres act as a scalar interferometer. If this biological scalar interferometer creates an endothermic (extraction) field on the surface of the skin of the feet, and simultaneously creates an exothermic scattering of the extracted energy into the surrounding environment, then one can walk on hot coals without burning the feet. Note that the reverse effect—cooling of the external environment—is often experienced when psychokinesis effects at a distance are obtained. For example, poltergeist effects are often associated with an adolescent. If the adolescent's cerebral scalar interferometer extracts by inverse scattering, and projects exothermically into distant objects, the movement of the objects can be explained.

63. Fission (action): the splitting of the action quantum into two canonical variables (for example, energy and time), only one of which can normally be completely detected or measured. ("Action" has the dimensions of angular momentum—energy x time, momentum x length, etc.) Fissioning produces length, discrete bit by discrete bit, and time likewise. The physical reality of separated physical objects is thus continually created, discrete bit by discrete bit, monocularly. All that ever exists in the "present" is a single quantum change, just occurring. Recombining of the two canonical action fission fragments is called "fusion." Fusion also occurs monocularly, quantum by quantum. Rigorously, the physical world of separated objects never exists as such except in memory recall of vast numbers of past ordered quantum changes that occurred one by one.

64. Flux: the amount of some quantity (such as energy, particles, volume of fluid, etc.) flowing across a given area (usually a unit area perpendicular to the flow) per unit of time. The term flux density is now more commonly used. Loosely, "flux" refers to the perpendicular flow through an area, while "flux density" refers to the magnitude or intensity (rate) of the flux. In some cases such as a flux of particles of different velocities, the number of particles may be multiplied by the average velocity to give an average flux density.

65. Flux density: the amount of some quantity (such as energy, particles, volume of fluid, etc.) flowing across a

given area (usually a unit area perpendicular to the flow) per unit of time.

66. Flying saucer: a discoid or other shaped paranormal object observed in the skies and/or landing, taking off, etc. Came into general use in the U.S. in 1947 after Kenneth Arnold reported seeing nine strange flying discs skipping along like saucers. Sometimes used to refer to an unidentified flying object (UFO). The usual "flying saucer" is theorized to be due to temporary materializations from the collective human unconscious; over 80% of these materializations only go so far as the "glowing light" stage, not to the material object stage. A small percentage do physically materialize, then later dematerialize. A small fraction of one percent are considered to be actual ships built on earth by the Soviet Union or one other country. A few sightings may be due to deliberate scalar interferometry at a distance by the Soviet Union and others.

67. Foo fighters: glowing balls of light which occasionally appeared in the skies and played tag with Allied, Nazi, and Japanese planes during World War II. The word "foo" is a corruption of the French word "feu," meaning fire.

68. Force: in mechanics, identically the time derivative of momentum. Simply, changing of mass-motion. One must realize that it is not the mass in motion, but the single undivided quantity "mass-motion" or "mass-velocity" (momentum) that is changed. In present EM theory, force fields are erroneously taken to exist in empty, massless vacuum. However, the mechanical definition is an identity, not an equality. Thus force does not EXIST ON a mass, but CONSISTS OF a changing "mass-motion." Since this force can be induced at a distance (by changing an introduced mass-motion such as a test charge), one is confronted in the new approach with the fact that there is a more fundamental mechanism that produces force itself. This mechanism is coupling of nonidentical scalar fields by and on a spinning charged particle. The INDUCED FORCE consists of the particle's change in mass-motion per unit of time. It is thus a flux—induced quantity in, on, and of a mass in motion.

69. Force field: an effect that can exist in vacuum or on mass whereby a particular type of matter is affected. For example, the "electrical (force) field" can affect and change the state of motion of any charged particle. In classical physics, the force fields are the causative agents; when these fields are zero, then the motion of the particle or system is unaffected. The electric field (E-field), for example, is defined as the force per unit of fundamental charged mass, though usually it is stated as "force per unit charge," with the mass ignored. Rigorously, however, force does not exist in vacuum, in the absence of mass, a priori. The Aharonov-Bohm effect shows that the potentials can interfere to produce effects in charged particle systems—even at a distance, and even when the force fields are reduced to zero. Tesla stated that vector Hertzian waves do not move through vacuum, which is true. Rigorously, two scalar waves move through vacuum instead. When coupled (detected) by a spinning charged mass (an electron, for example), the vector E and B fields are created on and of the moving mass itself; they do not exist in vacuum. This has been a fundamental omission and error in both electromagnetics theory and mechanics. For example, the standard EM equation,  $E = -0$  is not generally true in vacuum,

but it is true on an electron moving in a detecting antenna or on a charged particle moving in vacuum. Any force is produced by the same fundamental mechanism: flux differences encountered by a spinning charged mass. Thus there is a common connecting thread among all forces, and this is the key to a practical, engineering unified field theory. Note that Einstein's equivalence principle, after much pondering, can be taken to be an equivalent statement to the fact that force—any force—consists of a change in mass-motion. In modern quantum mechanics, force is an effect, not a cause, and is derived from the potential by a differentiating operator. The potential is the primary causative agent, not the force. Also, in modern quantum field theory, all forces actually come from curvature of spacetime—i.e., they are all gravitational in origin.

70. Four-space (4-space): a 4-dimensional spacetime, dimensionally composed of length cubed multiplied by time. In the absence of gravitational field, the 4-d spacetime reduces to a Minkowski space.

71. Fractional charge: a hypothetical particle having a charge less than the electron's charge. Often called a quark, where its charge is 1/3 or 2/3 the charge of the electron. Recently, Stanford University researchers have found evidence of free quarks, and in the 1920's Ehrenhaft reported the discovery and production of fractional charges of all sizes.

72. Frame (Lorentz): a frame of reference which is not accelerated with respect to the laboratory observer. In this case, the frame may be rotated (moving at a constant velocity) but it is not rotating (the frame is not accelerated with respect to the observer, and spacetime is not curved). In this case special relativity applies, as do the conservation laws. If the local spacetime is curved, the frame is accelerated and spacetime is curved. Locally, then, general relativity applies. In this case, locally the conservation laws (energy, momentum, charge, and spin) can be violated. However, in ordinary general relativity, it has been tacitly assumed that locally the curvature of spacetime is negligible. Hence locally a Lorentz frame is assumed, and the conservation laws are assumed to apply locally also. In scalar electromagnetics, the local spacetime is always curved and general relativity applies locally. In this case, the conservation laws need not apply.

73. Frame (ofreference): a spatial, organized, measured lattice placed in emptiness (space, spacetime). Normally refers to a 3-dimensional, spatial frame. All objects and points in the "universe" or spatial frame are considered to simultaneously coexist at separate, measured points in the frame. Differs from the vacuum in that, rigorously, vacuum has no existing definite lengths and no existing definite time intervals, as these appear only after measurement/detection, and are relative to the observer and to the detection process. The "laboratory frame" is the static reference frame of the observer/measurement. A separate reference frame may be assumed to exist for any fixed or moving object, or centered on any point in another frame. When a type of frame is assumed, the entire class of physical interactions that can occur has been restricted to an assumed set or type. In other words, given the frame, the physics has been assumed. One of the greatest restrictions of an assumed "frame" is to rule out the consideration (existence) of other higher dimensions. In the new theory, higher dimensions are permitted

and an orthogonally rotated frame can be equated to a field and vice versa. Therefore frames are also fields.

74. Free energy: energy obtained from a free or essentially free source. A paddlewheel in a river extracts and provides "free energy" from the river, since one need not pay for the river. Electromagnetically, the idea of "tapping" or extracting energy from an esoteric source, such as the zero-point energy of vacuum, the Dirac sea, a standing electrogravitational curvature of local spacetime, etc. Since scalar electromagnetics is electrogravitation, a locally bent spacetime can be achieved so as to provide either a source or a sink, as one wishes. Thus a practical free energy device is rigorously possible by scalar electromagnetic means.

75. Fusion (action): in the new approach, the recombining of two canonical bits of a fissioned action quantum. The fusion process "cancels" the bits produced by the fission process, and constitutes a negative spacetime operation. The physical world is thus eliminated, bit by bit, in a monocular fusion operation that produces the "past" The "mass" of a particle is taken to be proportional to, and identically comprised of, the absolute value of its fission and fusion rate. When fission and fusion rates of a particle are equal, the particle is unaccelerated; when unequal, the particle is accelerated. Vice versa, when the particle is unaccelerated, the fission and fusion rates are equal, and when the particle is accelerated, the fission and fusion rates are unequal.

76. Geiger tube (Geiger-Muller tube): a tube used in appropriate circuits to detect and count ionizing particles. Each particle crossing the tube causes ionization of the gas in the tube, essentially independent of the energy and nature of the nuclear particle. Thus a uniform discharge occurs across the tube. The tube will detect anything which causes an increase in the ionization of its gas. Since strong scalar waves will do this, the tube is capable of detecting scalar wave radiation of sufficient intensity. In many cases, GM tubes are activated near UFO landing zones, and sometimes near cattle mutilations or other paranormal occurrences. In such cases, the tube is reacting to scalar emissions, not nuclear radiations.

77. Geller effect: refers to the frequent stimulation of paranormal abilities in children and other people who have seen Uri Geller (or someone like him) performing psychokinesis either in person or on television.

78. General relativity: the physics of curved spacetime. As opposed to special relativity which deals with inertial frames moving at constant velocities with respect to each other (Lorentz frames), general relativity deals with accelerated frames. General relativity was founded by Einstein, who made highly restrictive assumptions to simply the complexity of the problem. Briefly, Einstein assumed that, since no means of appreciably curving spacetime was known except by the gravitational force of a tremendous collection of mass, then the only places where appreciably curved spacetime would be met would be near suns, stars, etc. Accordingly, he assumed that the local spacetime of the observer would not be curved, and instead the local frame would be a Lorentz frame. That is, he made the theory a sort of "special relativity with distant perturbations." That way, the conservation laws would be saved, and one could still speak of the energy of objects as opposed to the energy of entire systems. General relativity complete with this severe restriction is

called "ordinary general relativity" (OGR), and this is the type of relativity taught in all our Western universities. Note that, by assuming no local spacetime curvature, the ordinary theory actually assumes that one cannot directly (locally) engineer general relativity. OGR is a highly special case, and not at all the type of general relativity we seek in the new approach where we wish to deliberately curve local spacetime and engineer general relativity directly on the laboratory bench. The Soviets do not recognize Einstein's limiting assumption. In Soviet physics journals, papers are regularly published that treat general relativity in an unrestricted manner. These papers include local curvature of spacetime and violation of all the conservation laws as a result. In the West, conservation has been raised to an absolute dogma, and such papers are regularly refused publication. Conservation laws are upheld in the West by artifice and dictum, not by science or experiment! So if the various restrictive assumptions placed on ordinary general relativity are removed, then an "unrestricted general relativity" results. In this relativity, the local frame may be appreciably curved, and any or all of the conservation laws can be violated—often with ease. With an adaptation of Kaluza-Klein 5-d unified field geometry and use of artificial EM potentials deliberately created by summing or multiplying EM force field vectors to vector zeros, EM energy can be transformed into gravitational field energy locally. In this fashion one can engineer general relativity; violate conservation of charge, energy-momentum, and spin; produce free energy engines; transmute elements simply; and produce action at a distance. Initial experiments have positively established the new approach as valid, and a startling new physics is in the offing. In the new scalar EM, gravitational potential becomes locked-up (infolded) electromagnetic forces, and electromagnetic force fields become bleed-off (outfolding) of the inner contents of the gravitational potential.

79. Ghost rockets: materialized tulpoidal "rockets" that appeared in 1946 and 1947 over the Scandinavian countries (Norway, Denmark, and Sweden) and usually seemed to come from the direction of the Soviet Union.

80. Giant photon: a photon with an organized, deliberate scalar substructure. In scalar electromagnetics, the photon is assumed to be one oscillation of the electromagnetic field; thus it is comprised of one E-field wave and one B-field wave. Further, in each point of either wave, a finite group of vectors may exist such that their vector summation or multiplication is zero. Thus a deterministic substructure may be deliberately impressed upon (infolded in) the photon. Such a photon may carry enormous infolded energy in the form of anenergy, and may be designed to perform a particular resonant purpose. In other words, such a photon becomes a "vacuum engine" that structures the virtual particle flux of vacuum in a particular, deterministic manner.

81. Golden booster: a potent scalar wave generator invented by Frank Golden, and used to augment and amplify the Kelly radionics machine. The booster has the unique characteristic of gathering in ambient energy and EM radiation from its surroundings and transposing this into highly patterned scalar radiation. It has the further characteristic of reacting to human intent, and constructing its patterning accordingly. In addition, two motors are incorporated whose needle movements provide

visual indication of the rate of treatment, the frequency of treatment, and how the dosage is progressing. A Bedini scalar wave detector directly verifies that both the Golden Booster and the Kelly radionics machine produce and radiate potent scalar waves.

82. Golden, Frank: inventor and scalar electromagnetics researcher who has developed a variety of scalar wave antennas, an underwater communications system, scalar wave transmitters and receivers, the Golden Booster, scalar wave detectors, and scalar wave spectrum analyzers. He has also developed a prototype free energy motor, a motor that runs off reactive power, a solid state scalar radar antenna, and other significant scalar EM devices.

83. Good: refers to an act theoretically beneficial to the receiver or referent, in the positive time stream. It is equally detrimental to the referent, viewed in the negative time stream.

84. Gravitational field: rigorously, the curvature of spacetime. In scalar EM, gravitational potential is locked-up (infolded) electromagnetic forces which sum or multiply to zero. Electromagnetic force fields represent the "bleeding off" or "outfolding" of these infolded contents of gravitational potential. Gravitational force field is the "bleeding down" of the gravitational potential without unfolding or out-bleeding its infolded contents. Gravitational field is not a field in the sense of Heaviside-Maxwell electromagnetic fields. There is really no such thing as "the" gravitational field; instead, there exists a large number of potentials, locked-in force field vectors, and other entities which change the energy density of vacuum and bend spacetime. The bleed-down of this conglomeration infolded components as a conglomeration constitutes the "gravitational field." If the inner contents of this G-field, or of the G-potential, bleed out, then a different field—e.g., electromagnetic field—is produced. We may thus speak of the bleed-out of either the G-potential or the G-field. Note that flows between pairs, triads, etc. of these individual infolded field components can occur without appreciable change of the overall conglomerate's potential (trapped energy density). Thus the gravitational potential can have a dynamic, structured pattern, and local spacetime can be curved and patterned. E field and B field are one such "pair" of flows where little overall gravitational effects are evidenced, so long as the fields are free to "flow." In Kaluza-Klein 5-d unification of gravitation and electromagnetics, only a single field—the 5-dimensional gravitational field—really exists. Our world intersects and "bleeds-off" this 5-d G-field in two fashions: (1) the 5-d G-field prefers to bleed-out into its fifth dimensional aspect, which we see as our own ordinary EM force field. (2) The minute remaining 4-d aspects we see as our 4-d gravitational field. To show the order of magnitude difference in bleed-out, the electrical field between two electrons is about  $10^{42}$  or so stronger than the gravitational field between them. Even for protons, the ratio is  $10^{36}$  or so. So it can be seen that, so long as EM bleed-out is permitted, little 4-d gravitational effects are produced. Our normal electromagnetics—which by construction of Heaviside's version of Maxwell's theory is purely bleed-out, thus yields negligible gravitational effects. On the other hand, if we deliberately set the EM bleed-outs against each other so that they zero sum, we "strangle" the escape or bleed-off of the 5-d G-field into

EM field. The 5-d G-field is then forced to bleed-off into 4-d G-field. If we then vary the energy of each vector component of the EM zero sum while maintaining the overall zero resultant, we directly pump the 4-d gravitational field. Scalar electromagnetics thus directly converts EM field, force, and energy into ordinary G-field force and energy, and vice versa. In addition, we get enormous gains: For every unit of EM energy we feed into the "zero sum pump," theoretically we can get out up to  $10^{42}$  units of 4-d gravitational/inertial energy by electron release, and up to  $10^{36}$  by proton release. Experimental results have confirmed this thesis. As early as 1969, Hurvich produced an inertial field generator capable of "freezing" weapons so they cannot be fired. Hutchison reports and demonstrates the levitating of up to 60-lb. objects. The American physicist Hooper patented electrogravitational devices in the early 70's. Bedini, Watson, Johnson and others have developed practical prototype "free energy generators." Another inventor who wishes anonymity has developed a small device which produces negative energy and antigravity, at an amplification factor of 1,500,000. Orthodox research in this area is just beginning in the West, but has been highly developed for several decades in the Soviet Union.

85. Gravitostriktion: effect in a resistor whereby local gravitational stress flow in a direction results in production of a macroscopic electric force field in that direction, a macroscopic magnetic force field orthogonally around that direction, and minute, randomized EM fields (heat energy) microscopically due to induced microscopic particle motion and interaction. It is the enforced spin alignment of the mass particles (such as conduction electrons) which accounts for the production of the magnetic field. Gravitostriktion is the reason that resistive loads can be powered by scalar anenergy flow (electrogravitational flow, massless current flow) and by negative energy flow. During the initial chargeup of a helical coil exposed to a sine wave voltage, no electron mass current flows; however, the massless current ( $\phi$ -dot) charges up the coil gravitationally. As electron mass current begins to flow (90 degrees into the wave), this gravitational field is bleed-off (outfolded) as electric force field (electron mass flow coupled to  $\Delta\phi$ ) and magnetic force field. One can do amazing things with coils and transformers which are not allowed to enter the EM bleed-off phase at greater than 90 degrees

86. Gravity: the phenomenon characterized by the physical attraction of any two material bodies. Ideally, the gravitational force between two masses is proportional to the product of the masses divided by the square of the distance between them. In the new approach, one recognizes that mass itself is defined in terms of, and identically consists of, the time derivative of an action flux. Gravitational field and electrical field, then, become different aspects of the same thing. By affecting the flow of time, scalar waves and scalar potential thus are able to affect the gravitational force between two objects. Antigravity, for example, can be achieved by forcing an object's atomic nuclei to produce phase conjugate (time-reversed) waves (and negative energy and negative time). In negative time, gravity is a repulsion. Hutchinson has demonstrated the levitation of objects weighing up to 60 lbs, albeit sporadically.

87. H-field: historically, the magnetic field. However, it

is poorly named, and should be considered the magnetic excitation, after Sommerfeld. In empty space B and H are proportional, an experimentally determined fact. In the new approach, rigorously vector fields cannot exist in vacuum, but can only exist on an observable mass. A "shadow" vector field can exist in vacuum, in the absence of observable mass, as small virtual vectors, each existing on a virtual particle in the vacuum. Such a "shadow" vector field may be regarded as two coupled scalar fields, where the coupling is performed by the virtual particle flux of which the vacuum itself consists. When an observable, spinning charged mass encounters the shadow vector field, it converts the two coupled scalar fields into a vector field. Thus Hertz waves per se are not transmitted through vacuum; "shadow" Hertz waves arc. With an ordinary detector, however, one detects vector Hertz waves, since one detects the precession waves of the electrons in the electron gas of the detecting probe or antenna.

88. Hieronymus, T. Galen: renowned radionics experimenter and inventor of the amplified radionics machine. Hieronymus is the father of modern amplified radionics; most experimenters before him used unamplified machines.

89. Hieronymus device: essentially, an amplified radionics device. Refers to a device similar to the one patented by T. G. Hieronymus in the 1940's. Connnotes ordinary amplification rather than holographic amplification of radionics effects. Any similar type device. The Hieronymus device actually processes, and operates with, scalar waves.

90. Hologram: a photographic recording of the pattern of interference between coherent light reflected from the object of interest, and light that comes directly from the same source or is reflected from a mirror. When this photo image is illuminated from behind by coherent light, a three-dimensional image of the object appears in space. The characteristic of a hypothetically perfect hologram is that all its content is contained in any finite part of itself. If one portion is cut out and illuminated, the complete image appears in space. The whole hologram is in each part of itself. Observationally and perceptually, the physical universe is a hologram and in each part of itself, since all of it can be detected from/in each internal particle.

91. Hyperchannel: a channel between orthogonal frames or hyperframes, where anenergies crosstalk. Exceptionally good hyperchannels seem to be frequency dependent, and are referred to as windows, magic windows, or interdimensional nodal points. Some hyperchannels are 38-40 kHz, 150-160 kHz, 1.1-1.3 MHz, 1.057 GHz (the Lamb shift), and in the near ultraviolet (the life force frequency). These frequencies also represent enhanced channels between subquantal (virtual) and quantal (observable) states. A particularly good magic window exists when the infrared and ultraviolet bands being utilized are phase-locked so that the ultraviolet represents a first harmonic of the infrared.

92. Hyperfield: a structure or disturbance in hyperspace or higher dimensional space. With respect to a fixed frame, the electromagnetic field or a more subtle field. We consider the electromagnetic field the first hyperfield. A hyperfield may also be considered to be the electromagnetic field rotated further away from its laboratory frame. The second hyperfield is called the

neutrinic field, and the third hyperfield is the mental or mind field. Also called bioframe, orthoframe, hyperframe, biofield, or orthofield. These hyperfields/hyper-spaces also correspond to the nested levels of virtual state. Successively higher hyperfields past the electromagnetic field constitute successively lower levels of virtual state.

93. Hyperframe: simply, a frame rotated one or more right angle (orthogonal) turns away from the reference laboratory frame. The laboratory frame is considered to be the zeroth hyperframe. Also called bioframe, bio-world, biofield, orthoframe, orthoworld, orthofield, hyperfield, or hyperworld. Sometimes referred to as a hyperspace.

94. Hyperspace: generically, refers to hyperframes, orthoworlds, etc. May be used in a singular sense to refer to one of these.

95. Hyperspace howitzer: a postulated Soviet scalar electromagnetics interferometer weapon, believed capable of firing an explosion through hyperspace to a distant point, without any travel of electromagnetic energy through ordinary space. Also called a scalar howitzer or Tesla howitzer. The howitzer has several modes of operation: (1) it can be used in exothermic or endothermic mode. In the exothermic mode, the howitzer is biased positively. In this mode it can accept energy, transform it into scalar waves of an artificial potential or anenergy, transmit the scalar waves to a distant intersection zone, interfere them and reproduce ordinary positive electromagnetic energy in the distant region. In the endothermic mode, the howitzer is biased negatively. In this mode it "transmits" the extraction of energy. At the distant interference zone, energy is extracted and reappears back at the transmitter/receiver site, where it must be disposed of. U.S. weather satellite photos of the Soviet Union's Bennett Island reveal giant exhausts emerging from that island, some narrow jets as long as 150 miles and only about 1.5 degrees above the horizontal. Bennett Island is believed to be the "exhaust site" for several Soviet hyperspace howitzers. That is, when a howitzer operates in the endothermic mode, it receives and temporarily holds the energy that comes back to it, then switches biasing potential to positive and transmits in the exothermic mode to Bennett Island. (2) The howitzer can operate in pulsed or continuous mode. In pulsed mode, an explosive or implosive effect occurs at the distant target site. In continuous mode, a continuous energy source or sink appears in th distant interference zone. (3) Fourier expansion mode. Each transmitter of the howitzer can produce multiple frequencies where the frequencies represent a Fourier expansion of a geometrical form such as a sphere. When these two geometrical scalar forms are interfered at a distance, a 3-dimensional form of ordinary EM energy emerges (exothermic mode) or is extracted (endothermic mode). (4) the scalar transmissions of the scalar interferometer (hyperspace howitzer) can be modulated upon ordinary EM carriers, such as the Woodpecker signals in the communications band (3 to 30 megaHertz). In this case, interference patterns of the Woodpecker carrier will yield only minute EM energy, but the impressed scalar substructures may interfere to produce or extract substantial energy in or front the interference zone. Other control signals impressed on the Woodpeckers may be used to trigger the mode and location in the interference zone, or

even to establish "circulations" in the vector zeros. By forming distant high pressure zones (exothermic mode) and low pressure zones (endothermic mode) and then moving the locations along, the Soviets can capture and deviate the jet streams over North America or elsewhere. By swirling in conjunction, tornadoes can be produced. Certain signatures (giant radial clouds and twin giant radial clouds) in the active zone have been identified as associated with the Soviet Union's weather engineering. The strange explosion in 1958 near the Urals is believed to have been an accident involving an early first fullup test of the howitzer. The howitzer was probably similar to a giant radar, transmitting scalar EM wave. By setting up a standing scalar wave and continuing to transmit energy into it, the standing wave becomes a giant potential. It is charged up much like a scalar capacitor, but with scalar EM (electrogravitational) energy. Failure of the transmitter may have discharged this giant potential into the earth, and the electrogravitational ground pulse spread out, striking the nearby stored nuclear wastes and fissioning all the radioactive nuclei. Consequently the nearby atomic wastes exploded, producing fallout and radioactive contamination over a large area. The first fullup test of an operational on-site weapon is believed to have been the destruction of the U.S.S. Thresher atomic submarine on April 10, 1963. The second fullup test is believed to have been the transmission of an explosion into the ocean 100 miles north of Puerto Rico on April 11, 1963—one day after the destruction of the Thresher. Over a hundred howitzers are believed to now be on site and operational, and powered by either Moray amplifiers or giant scalar resonant inference taps in the earth (detected by Golden in April 1985). High Altitude booms off the east coast of the U.S. may have been due to orientation and alignment tests of these weapons, with each test blast the equivalent of some 100 tons of ordinary explosives. If so, these shots were probably artillery high burst registrations. The two puzzling flashes detected by the Vela satellites in September 1979 and later, and erroneously described as a nuclear flash by many analysts, may also have been a test of this type of weapon, either by the Soviets or a second nation that has developed the weapons.

96. Hyperworld: a world (3-space or 4-space) rotated one or more orthogonal turns away from the laboratory frame (ordinary world). Constitutes also (identically) an entire subquantal level in virtual state.

97. Inception: kindling (from mind anenergy) a small amount of photon energy into or onto a body/tuner or other object. Specifically, coupling scalar wave patterns (anenergy) onto the body/tuner or object so that the photon energy is created in or on the body at a distance.

98. Inceptive cyborg effect: the ability of the mind to psychokinetically link to, or attune to, an inert physical object or physical system. A living biological system is a stabilized inceptive cyborg, with its mindworld linked to its body/tuner. The two cerebral hemispheres of the brain form a Tesla scalar interferometer, capable of producing and transmitting scalar wave patterns into a distant object, coupling into energy in it, and thus linking with or resonating with the object. This is the mechanism for producing all parapsychological phenomena.

99. Interdimensional nodal point: a natural frequency for an anenergy channel between orthogonal frames or universes. Also called a magic window.

100. Interference: the variation of the amplitude of a wave with distance and time, where that wave results from the superposition of two waves having the same, or nearly the same, frequency.

101. Interferometer: an instrument in which a wave is split into two waves or beams, which after traveling over different paths are subsequently reunited and display interference.

102. Jitter (dither): the incessant quantum and subquantum activity on a fundamental particle of mass. The particle is continually connected to and disconnected from an infinite number of hyperspaces, and to and from time.

103. Kaznacheyev effect: refers to the demonstrated ability of near-ultraviolet mitogenetic photons to carry any kind of death pattern from one cell culture to another of similar kind, in the absence of visible light and with synchronized conditions. Named after the Soviet scientist Vlai P. Kaznacheyev, who experimentally demonstrated the effect. In his experiments, two samples of the same cell culture were environmentally separated by a thin window. The entire arrangement was placed in the dark and rotated at some 20 rotations per minute. The cells on one side were then killed by any particular mechanism—ionizing radiation, chemicals, toxins, deadly bacteria, germs, etc. If the window was made of ordinary glass (opaque to ultraviolet), the second sample remained healthy. If the window was made of thin quartz (transparent to ultraviolet), then after a time delay the second sample began dying with the same symptoms as the first. Later testing revealed the emission of mitogenetic, laser-like photons in the near ultraviolet from the dying cells in the first culture. When these mitogenetic photons are allowed to bombard the second culture, the same lethality pattern is induced in it. The explanation is that the photons carry virtual state (scalar) patterns (folded patterns in their time components), and these virtual patterns are diffused into the receiving culture, where eventually they diffuse into a lethal pattern in the virtual state (scalar) master control system (discovered by F. A. Popp) of the targeted cells. Continued charge—up of this pattern kindles the pattern into a physical, observable structure in the cells, reproducing the death or disease pattern. The Kaznacheyev effect has been duplicated in the infrared in West Germany. Kaznacheyev almost certainly also phase conjugated (time-reversed) the "death photons," producing healing photons for that specific cellular damage or disease condition. Irradiation of the affected cells with these healing photons would have reversed the disease, reverting the cells to normal. Note that Antoine Priore's machine worked in this fashion. Kaznacheyev's EM healing work with phase conjugated photons was obviously not reported; it represents a total counter to viral biological warfare, and such work would have been done only under KGB control, and highly classified as a vastly valuable defense secret.

104. Kelly, Peter: noted radionics/psychotronic researcher and builder of several types of especially potent amplified radionics machines. He is also one of the pioneers of the use of amplified radionics in agriculture for enhancement of crops, restoration of soil vitality, and control of insects. By direct measurement with Bedini scalar EM detectors, Kelly's machines have been verified to produce scalar waves.

105. Kelly machines: amplified radionics machines developed and built by Peter Kelly.

106. Kervran effect: the ability of a living biological system (either plant or animal) to accomplish limited transmutation of elements, particularly between certain isomers. Named after the French scientist, Louis Kervran, who discovered the effect. Kervran was nominated for a Nobel prize in 1977, although the prize was not awarded to him. The Kervran effect has been duplicated by Japanese, British, European, American and other scientists. Note that scalar interferometry is capable of kindling energy patterns directly into the virtual state interactions of the nucleus, including the strong force that binds the nucleons together. Over a period of time, this energy can cumulate, biasing the quantal statistics of the interactions. This, of course, changes the probabilities of the various quantal states, with the result that the nucleus can be transmuted. Transmutation to an isomer is particularly practicable. Efficient transmutation of elements by scalar means has been accomplished by John Bedini.

107. Kindling: collecting and condensing more subtle energies (anenergy) into virtual photons (charge effects), photons (electromagnetic field effects), or matter (materialization effects). Kindling is a linear integration process, which repeatedly collects or integrates a virtual state pattern until it breaches the observable threshold, becoming physical real.

108. Kirlian photography: field patterns of an object impressed upon a film or other sensitive material by means of spark discharges. The scalar modulations in the spark charge intensity, not the ordinary vector E-field components, are the paranormal components. Thus only the delta—which represents those scalar patterns coupling and kindling into vector EM, which then interacts in photochemical interactions—is indicative of the paranormal aspect of Kirlian photography.

109. Law of physics: a restriction placed upon the physical mechanisms that can occur under certain broad assumptions as to the background situation and environment. Actually, in nature there are no such "laws"; these are only man's synthesis for the behavior of large classes of systems under very general conditions. Any "law of physics" can be violated if the conditions contained in its assumptions are violated. Conservation laws are often touted as "laws of physics." Actually, the conservation laws assume a closed system and a linear spacetime (Lorentz frame). If either or both of these assumptions is violated, any or all of the conservation laws can be violated. In particle physics, broken symmetry already results in violation of one or more of the conservation laws. In leading Soviet physics journals, papers are regularly published containing unrestricted general relativity with concomitant violation of any and all conservation laws.

110. LIDA machine: Soviet device which uses a 40 megahertz carrier and unusual waveforms to induce a catatonic-like state in man or other mammals. For years Western orthodox scientists have argued that EM signals could not directly affect consciousness. With testing of the LIDA device, this has now been totally refuted. One scientist has reported that the LIDA device—known to be decades old—was used by the North Koreans on some U.S. prisoners of war during the Korean War. Reportedly the effects of the machine could not be resisted, and the

machine was a devastatingly effective "brainwashing" tool.

111. Life: a term which resists the best efforts of philosophers and scientists to define it! In the new approach, a living system is modeled as consisting of a physical body "tuner" and a mindworld to which the tuner is preferentially tuned to a small degree. The preferential virtual state crosstalk between the physical tuner and the mindworld constitutes the life channel or consciousness loop. Destruction or loss of the preferential tuning results in "death," or loss of attachment to the tuner. In that case the mindworld functions within itself. Note that the being is always present, unchanging, and simply "is," without any connotation of perceptual stringing together separations into a string of events (causal chains). Being changeless, it consists of all changes, all-at-once, hence none separately. Ultimately this is the true meaning and foundation of life, and mindworlds and physical events represent simply separation waves in unlimited being. Note this is completely consistent with the idea that ultimately only God exists, things are simply separation waves in the unseparated Godness, and God permeates everything.

112. Loch Ness Monster: famous tulpoidal water monster which (occasionally) temporarily materializes in Loch Ness in Scotland. Similar materializations of "water monsters" have been seen and reported in almost every large body of water on earth.

113. Longitudinal wave: a "pressure" type of wave, similar to sound, in which the vibrations are along the direction of travel of the wave. Hence, a wave composed of alternating densifications and rarefactions. Scalar waves are longitudinal waves. In classical EM theory, the Poynting vector predicts no longitudinal wave of energy from a time-varying, electrically charged source. In fact, an exact solution of the problem does allow this longitudinal wave, as shown by Keech and Corun, *International Journal of Theoretical Physics*, Vol. 20, No. 1, 1981, pp. 63-68. The classical electromagnetic wave is modeled as a vector wave, comprised of transverse vibrations. In the new approach, such transverse vector force field waves (Hertz waves) do not exist in vacuum; instead, two coupled longitudinal scalar waves exist in vacuum. The E and B fields are formed, recovered by, and exist as the spinning charged detecting mass particle in motion.

114. Magic window: a naturally tuned frequency of a good hyperchannel between orthogonal frames where scalar wave anenergies crosstalk readily. Magic windows are frequency dependent, and are also referred to as hyperchannels or interdimensional nodal points. Some magic windows are 38-40 kHz, 150-160 kHz, 1.1-1.3 MHz, 1.057 GHz (the Lamb shift), and in the near ultraviolet (the life energy frequency).

115. Many-worlds interpretation of quantum mechanics: refers to the consideration of multiple simultaneous observers and the consequent changes forced upon quantum physics. Essentially all possibilities exist and are real, and an infinite number of orthogonal worlds exist at any instant. Further, each world splits into multiple possibilities after each and every event. Thus in a single second, the world has split in some 10 to the 20th power versions of itself. This is the work primarily of Everett, with strong contributions by Wheeler and



Graham, and was the subject of Everett's thesis at Princeton University in 1956. It was published in 1957.

116. Mass: literally, a special curvature or "kink" in spacetime emptiness, according to relativity theory. In the new approach, the mass and inertia of a particle are considered to be due to one or more standing scalar resonances, trapped by the spin of the particle. When the amplitude of the trapped scalar wave increases or decreases, the mass and inertial of the particle increase or decrease. If the resonance amplitude reduces to zero, the particle dematerializes. Classically, mass is also taken as the measure of a body's resistance to being accelerated by a force. Specifically, a mass occupies space (3-dimensional) and resists change in its linear movement. In a region of mass, a flux of action quanta into and out of the region exists, corresponding to a flow of positive and negative time. The mass is the sum of the absolute values of the time derivative of action in and the time derivative of action out. If these two time derivatives are equal in magnitude, the mass is unaccelerated; if unequal, the mass is accelerated. A mass does not exist in time per se (more rigorously, it exists equally in positive time and in negative time), but only exists spatially. A mass continually interacts with photons (absorption and emission), thus continually connecting and disconnecting to the fourth dimension (time). The mass is thus seen to "jump along" through time in finite, quantized jumps caused by the photon interaction with it.

117. Men-in-black: that part of the UFO contact phenomena which involves contact with rather sinister tulipoidal manforms. Typically these tulipoids are dressed in dark suits, have almond-shaped eyes that do not blink, possess oriental features, and "speak" telepathically to the contactee. Often they drive dark automobiles and follow the contactee. Several researchers in the field have had intense encounters with such tulipoids. The appearance of such phenomena associated with an investigator is in part due to unresolved detrimental material in his or her own unconscious mind, which thus acts as a "witness" and radionics tuner. Continual stimulation of this detrimental unconscious witness by the person's investigative activities results in the appearance of, and contact with, such tulipoids. The more detrimental aspects of such tulipoidal tuning can be prevented by psychic clearance of the investigator, particularly of his unconscious mind. Such psychic clearance at regular intervals is highly recommended for investigators pursuing the more bizarre aspects of the field, such as cattle mutilation, men-in-black, sasquatch, possessions, etc.

118. Metal bending: term applied to the psychokinetic bending and breaking of metal objects such as cutlery, rods, bars, etc. When a metal rod is psychokinetically bent, then cross-sectioned and examined under the electron microscope, microscopic "puddling", as if by localized, point source intense heating, can be seen, with concomitant disruption of the metallic grain structure. In a severe case, the cross section looks like the puddled surface of the moon. The mechanism responsible for the psychokinetic bending is exothermic scalar interferometry by the two cerebral hemispheres, where the intersection zone is the metal object being bent.

119. Metapsychology: literally, "before psychology." The deeper psychology of the group mind, particularly the collective human unconscious mind. Although the Cartesian idea of the separation of mind and matter usu-

ally applies to the individual conscious mind, it does not apply to the group unconscious mind. The collective human unconscious mind is a living being, though unconscious, and is capable of materializing its "dreams" into actual physical forms and beings.

120. Microcrystals: tiny crystals, particularly those used by George Yao in construction of his pulsors. Use of the microcrystal in proprietary manners enables Yao to build devices which react to scalar resonance and human intent, and which can generate negation patterns for potentially harmful "deltas" or changes that occur in the human etheric field (aura).

121. Miller/Fox/Urey effects (experiments): these experiments simulated the primitive conditions believed to have existed in and over the primeval oceans. Water—with its complement of minerals and chemicals—and gases to simulate the primeval atmosphere were placed in a beaker and subjected to ultraviolet radiation and electrical discharges. Thus the experiments simulated the great lightning discharges into the primeval oceans. In the laboratory, amino acids are formed, then proteinoids. If the experiments are performed in the presence of heating (simulating the presence of volcanic activity, for example), then primitive microspheric cells are formed with double cellular walls. These microspheric cells even reproduce by cell division. Thus at least simple lifeforms have been produced in the laboratory. Indeed, in the new model even inert matter is totally alive, but unpreferentially. Also, every possible sort of mind exists. Thus all that is necessary to form a living system with any desired characteristics is to form the appropriate type of physical tuner. A living system is like a television set existing in a flux of radiations from an infinite set of channels/stations. The set tunes preferentially to one channel/station, but any desired channel can be tuned, simply by changing the characteristics of the tuner. One does not "create" life, one simply "tunes it in selectively." In this concept rigorously there is no such thing as "death", but only transition from one state to another.

122. Mind: a quite misunderstood concept! In conventional science, it is considered purely robotic—i.e., it is the sum total of the electromechanical neural processes which receive, code, and interpret sensations, recall and correlate stored information, and act upon it. Also considered to be the understanding, reasoning, and intellectual faculties considered as a whole, that is, as the conscious portion. Also considered as the psyche, including the conscious, subconscious, and unconscious portions, considered as a whole. The new approach is more in accord with the latter definition. Simply put, the mind is a world composed of separation events (waves, operations, processes) in unseparated being. We may model it (to a first crude approximation) as a physical universe, three orthogonal turns away from the ordinary physical universe, and tuned slightly selectively to one physical organism's physical body processes. Mind anergy is considered to be progressively collected, condensed, and kindled into denser substance and objects by rotation toward the ordinary physical world. Thus a piece of inert matter is simply condensed energy, which itself is condensed anergy, which is condensed mind flux (crosstalk) from all minds. One may model the mind physically, or model the physical as mindstuff, eliminating the artificial dichotomy between mind and matter that presently is assumed in orthodox science. Since per-

ception of thought is fragmentation and separation of mind, the mind cannot be perceptually conscious of itself, but only of its separated fragments (thoughts). When the incessant activity of the mind is stilled, however, the stable mind is in its pure state—pure being. In this state there is no separation of the observer and the observed. With attainment of this state, one "realizes" or experiences one's true God-nature. It is theoretically possible to build a scalar wave detector that can directly "see" thoughts. Indeed, the first prototype of this type detector may have already been built by one physicist experimenting with a very sensitive scalar wave detector.

123. Mind linkage: the integrating of two or more minds into a single overall functional mind. A living example is in each human head: the two cerebral hemispheres—each containing its own separate mind—are integrated into one overall brain having a single functional mind. This is accomplished by signals interconnecting the two cerebral hemispheres through the corpus callosum. Note that the "separated beings" of the two minds are also merged/linked into one greater being. The tuned separation of individual humans (caused by the continual photon interactions with each particle of mass in the body tuner) is responsible for all man's inhumanity to his fellow man, for each now perceives others as separate things or "objects." With mind linkage, the human species will emerge as a single great entity, having not only a single "collective unconscious," but also a single "collective conscious" mind. Proof that linkage can be accomplished is already demonstrated by each individual. The problem of resolving all man's inhumanity to his fellow man is thus a technical problem, not just a moral/philosophical problem.

124. Mitogenetic radiation: laser-like, coherent photons emitted by cells, particularly in the near ultraviolet. Of particular importance are the photon emitted by a cell immediately after complete fertilization, and the photon emitted as the cell dies. The first mitogenetic photon signifies the kindled connection of the cell's small mind-world and the establishing of the consciousness or life loop. The second mitogenetic photon signifies the loss of tuning and consequent loss of the consciousness or life loop. The photon at cellular fertilization is a joyous song of birth, and the photon at cellular death is a death song of the cell. In addition, the birth photon carries the full mindworld pattern nested inside it in the virtual (scalar) state, and the death photon carries the full pattern of the cell's experiences and death nested inside it in the virtual (scalar) state.

125. Monocular (change): one at a time. Change as seen by only a single observer at a time. This type change is provided by the photon interaction with matter, and the "memory hold" of a large number of such monocular changes constitutes the "perceived/detected physical reality" we conceive we exist in.

126. Moray amplifier: free energy device developed by T. Henry Moray of Salt Lake City, Utah in the 1920's and 30's. The device was destroyed by a double agent (an F.B.I. agent and also a Soviet agent) in 1939, after the agent had obtained the drawings of the device and worked in Moray's laboratory for several months. The final device had some 29 detector stages and produced an output of 50 kilowatts of power, without input.

127. Moray, T. Henry: early experimenter and pioneer

in radiant energy, who developed one of the most widely demonstrated and best authenticated free energy devices. Moray's device was a collector/amplifier that eventually produced 50 kilowatts of output power.

128. Multiocular (change): more than one at a time. Change as seen by multiple simultaneous observers. Consideration of this type change leads to an infinite dimensional, multiworld or multiverse reality similar to the type described by Everett. If one accepts multiple simultaneous observers, then this expanded and startling view of reality is inescapable. If one accepts only a single observer at a time (as does present physics), then there exists only a single living person, and everyone and everything else is simply a figment of his or her imagination.

129. Mystery light: another name for a nocturnal light, or earthstress light, produced by natural scalar transmission interferometry of the cracked rock structures in the earth's crust

130. Neurophone: an instrument for direct electromagnetic input of signals into the human brain and nervous system. The neurophone was invented by Pat Flanagan when a boy of seventeen. The improved version, invented much later by Flanagan, clips an input signal, differentiates it twice, then feeds the resulting noisy spikes into the human sensory system. The original signal is impressed into the brain and directly into the mind. An adaptation of the neurophone, using more than eleven independent frequencies and built in accord with Soviet work reported by Lisitsyn, could conceivably be utilized to accomplish human mind linkage.

131. Neutrinic wave: a bare neutrino, considered as a wave instead of a particle. It is a special kind of polarization wave to the laboratory observer, and interacts with his electromagnetic field. It is essentially a longitudinal scalar wave, which moves in and on ordinary vector electromagnetic waves. It may also be regarded as a sort of "spin" wave, since one may consider it as moving at the speed  $c$ , but circling around a photon in a plane perpendicular to the photon's velocity in 3-space. One may thus say that the neutrinic wave moves at the velocity  $c$ -squared, but its carrier moves at the velocity  $c$ . Since we detect the speed of the carrier, detected neutrinos always appear to have moved at the speed of light.

132. Neutrino: a neutral particle believed to have zero rest mass and travel at the speed of light. One type of neutrino is associated with the electron and one type with the muon. A third type is now believed to exist. There is some evidence recently of neutrinos possibly having a small mass, and of one type of neutrino turning into another type. In the new approach, the classical neutrino is a flux of much smaller particles—"bare" neutrinos—inside a photon. In the photon, one flux is taken to rotate clockwise and one flux to rotate counterclockwise (adapted from the phasor theory of Ruderfer). Further, a neutrinic flux from one half of the photon to the other is hypothetically possible, and this flux would constitute a third type of neutrino. It would exhibit mass, and would allow one type of neutrino to turn into the other. The bare neutrino (from the new approach) is of magnitude  $1/c$  times the magnitude of the photon. Further, it moves at the speed  $c$ -squared, but since it circulates at the speed  $c$  at right angles to the motion of its photon carrier which is moving at the speed  $c$ , its detected velocity is always  $c$ , the speed of carrier. To an observer in the hyper-

frame of the electromagnetic field, a laboratory bare neutrino would appear as a photon.

133. Newman, Joseph: Mississippi inventor of a free energy machine tested and authenticated by several dozen scientists. Newman is fighting in court to obtain a patent on the device which has clearly been shown to be legitimate.

134. Newman machine: free energy device developed by Joseph Newman. While the prototype does not produce appreciable output power, it does produce an output and keeps its own small drycell batteries charged. It clearly demonstrates the principle and is a legitimate free energy device.

135. Nocturnal light: any paranormal light phenomenon seen at night. Over 80% of the UFO phenomena are nocturnal lights. Also includes phenomena such as "ghost" lights, spooklights, will 'o the wisps, etc. It specifically does not include ball lightning, St. Elmo's fire, and other such rare but normal phenomena. Most of the nocturnal light phenomena are caused by natural scalar transmission interferometry.

136. Observable (state): that part of physical reality consisting of changes (particles, waves, action changes) that are detectable by single instruments. The field on a charged particle is due to the continual emission and absorption of virtual particles. Forces between observable particles are generated by the exchange of virtual particles. Thus all observable forces, fields and changes are generated by unobservable virtual interactions, and observable and virtual reality states are inseparably enmeshed. In theory, no superluminal effect can be directly detected; however, a two-stage detection can be used to detect a superluminal entity. Usually the first stage is an interference between two superluminal entities, where the interference "downshifts" the waves to produce a wave moving at subluminal velocity. This subluminal wave then interacts with a mass such as an electron, and these interactions are accumulated to provide a macroscopic measurement indicative of the presence of the primary superluminal interferences. A two-slit box for the electron interference experiment is an example. Also, in quantum mechanics time is not an observable, even in theory. All observation is spatial; rigorously, there is no such thing as a clock in the purest sense. Time is always inferred from a spatial detection or measurement

137. Orgone energy: the subtle living or life energy discovered and utilized by Wilhelm Reich. Reich had discovered and utilized a portion of scalar electromagnetics (electrogravitation).

138. Orthoframe: a frame rotated away from the laboratory frame by one or more right angles. A hyperframe or bioframe. Also called an orthoworld.

139. Orthogonal: simply, at right angles. The intersection of two orthogonal geometric constructs, each of dimension one or greater, is of one less dimension than the lowest dimensioned intersector.

140. Orthorotation: rotation in hyperspace of an object, form, or particle at a right angle to its starting frame. The object loses one dimension in its intersection in the original frame and gains one dimension in its intersection in the frame toward which it rotates.

141. Orthoworlds: orthogonal 3-dimensional physical worlds (frames) that share a single time dimension in their 4-spaces (spacetimes).

142. Paradox (logical): a thing that is true, but which

violates one or more of the three Aristotelian laws of logic. All logical paradoxes are simply fourth-law logic cases, and—at least hypothetically—the fourth law can be applied to resolve them.

143. Paranormal phenomena: any phenomena that differ from straightforward, orthodox physical or psychological phenomena. Phenomena beyond understanding in terms of presently known science, causes, and effects. Specifically, phenomena in which mind and matter, or mind and unknown fields, or matter and unknown fields interact observably.

144. Past: reality which has been erased and has ceased to "physically (observably exist)" in immediate detection/perception, and which now exists only as an infolded virtual state trace or vacuum memory. (Because the past still exists as an infolded virtual trace in vacuum, the time-reversed wave emitted from a pumped phase conjugate in four-wave mixing can retrace the past path of the wave that struck the mirror and stimulated the emission.) Fissioning of an action quantum produces a "presented" change described by canonical fragments. Fusion of the canonical fragments back into a quantum of action erases the presented real canonical fragments, reducing the "change" to the "past" However, that "fissioned pattern" or virtual substructure continues to exist, infolded into the vacuum. The vacuum retains a perfect infolded recorded memory, therefore, of every quantum change that has ever occurred. (In ancient mystery schools, the set of all such traces was called the Akashic record.) A virtual projection of the change has occurred in the mind world of the observer, however, since the mindworld is nonlocal. The coherent (causal) time-ordered collection of large numbers of such virtual projections in the mindworld reaches the quantum threshold, resulting in a quantum change in the mindworld. The "conscious mind" thus perceives physical reality as a collection of a large number of quantum changes—in short, a macroscopic reality. In actuality this "perceived macroscopic world" rigorously exists only in the mindworld, and thus it exists only in the past (Note how physicist's discussions of such quantum paradoxes as Schrodinger's Cat are erroneously based on macroscopic considerations.)

145. Phase conjugation: a nonlinear wave process whereby a nonlinear crystal, material, or medium creates a nonlinear polarization for an incoming monochromatic wave is generated at the incident frequency by  $w-w-w=-w$ . The nonlinear polarization radiates a time-reversed replica of the incoming waveform. The time-reversed waveform has an amplitude proportional to the complex conjugate of the incoming wave amplitude. Though primarily known in nonlinear optics, the time-reversed wave is a solution to the wave equation, and so the phenomenon is universal to all kinds of waves. As can be seen from  $(w-w)-w = -w$ , the first two waves modulate each other because the nonlinear medium acts as a modulator. These two waves thus "lock together" as a single scalar EM wave. The scalar wave passes through the electron shells of the atoms of the nonlinear medium, penetrating to the positively charged atomic nuclei. In a nucleus, each incident scalar photon is absorbed, increasing the potential of the nucleus to an excited state. The decay of this excited state from the positively-charged nucleus causes the emission of a time-reversed (TR) photon carrying negative energy. The "emitted shower"

of these TR photons constitutes a TR wave. Thus from the nonlinear material there is emitted a time-reversed wave. This TR wave "backtracks" through space along the invisible path taken by the original incoming wave. Since the phase conjugate wave is time-reversed, it concentrates along its backward path, rather than diverging. Consequently all its energy arrives at the distant location of the source of the original stimulus wave. The nonlinear medium producing the TR effect in response to a stimulus wave is referred to as a phase conjugate mirror. If two monochromatic EM waves  $w_1$  and  $w_2$  are fed into the nonlinear medium in antiparallel manner, so that the waves are everywhere out of phase, they modulate each other, forming a much more powerful scalar EM wave. This wave then "pumps" each nuclear potential to a much higher excited state. Thus when this potential decays, a much more powerful TR wave is emitted, containing up to all the energy put into the scalar "pump" wave. Note that the excited nuclei do not decay (the excited potential does not decay) until an incoming stimulus wave—say  $w_4$ —is received. When  $w_4$  is received, then a powerful TR wave—say  $w_3$ —is emitted from the phase conjugate mirror (PCM). This process is referred to as "four wave mixing." Thus a pumped PCM acts as a triode amplifier, and the incoming stimulus wave acts as a signal on the grid. In the oscillation condition (incoming input  $w_4$  at right angles to  $w_1$  and  $w_2$ ), infinite gain is experienced, so that all the energy in pump waves  $w_1$  and  $w_2$  appear in TR wave  $w_3$ . This was Nikola Tesla's secret of wireless transmission of energy at a distance without losses; the Great Electrician had discovered what we today call phase conjugation and the pumped phase conjugate mirror. He also discovered its general nature, for he understood that it applied to all kinds of waves, including mechanical waves in the earth. It has been shown that, under proper conditions, it is possible to have self-oscillation in the nonlinear crystal or medium. Such a PCM is referred to as a "self-pumped PCM." Indeed, Tesla's original Magnifying Transmitter would have utilized the earth itself as a self-pumped, amplifying PCM—in other words, as a giant triode where the molten core of the earth already furnished the cathode power for free. A relatively small input "grid signal" (from Tesla's resonant transmitter) would thus have set the earth itself into scalar resonance (giant self-pumping), eliciting an enormous time-reversed wave energy resonant response from the core of the earth. Anyone anywhere on earth with an antenna tuned to the stimulated frequency would have received cheap or "free" energy from the earth itself. The Soviets presently use a version of this method to power their enormous scalar EM wave Tesla weapons. All unorthodox resonant free energy devices (built in secret by unorthodox inventors) presently use variations of this same principle.

146. Photon: the basic action quantum. It may be considered as an oscillation in and of time. It may also be considered as a virtual pattern of positron/electron pairs. A piece of electromagnetic radiation when it interacts as a particle. One half the photon exists in and carries positive time (negative charge), and the other half exists in and carries negative time (positive charge); thus one half is "normal" and the other half is "time-reversed" (phase conjugated). The magnetic field of a permanent magnet, for example, thus consists of two types of coincident magnetic field lines: one line of each coincident pair is in

positive time and by convention runs from the north pole to the south pole, while the second line of the pair is in negative time and runs from the south pole to the north pole. The two lines may be considered as two streams of particles, one negative and the other positive (Howard Johnson's two-particle theory of magnetism). The photon may be considered as two contrarotating neutrinos, after the work of Ruderfer. In the new approach, each of these rotating neutrinos is considered to be composed of vast numbers of circulating bare neutrinos. The photon may be considered as one cycle of an electromagnetic wave. The photon is the basic carrier of time and consists of a piece of energy welded to a piece of time, with no seam in the middle. The passage of "time" thus moves at the speed of light, its carrier. All ordinary photons possess the same action magnitude,  $h$ , although they do not carry the same energy. If the photon is made subquantal (i.e., less than  $h$  in magnitude), it is a virtual photon of the type whose emission and absorption cause charge on an electron. Virtual photons are not individually detectable, even in theory. However, a virtual photon may have positive mass under some circumstances.

147. Photon interaction: the absorption and emission of photons by particles or objects. Usually the photon interacts with an orbital electron, being absorbed by the electron which is raised into an excited state. Then the electron decays from the excited state, emitting another photon. The macroscopic world is created by this interaction, which is the basic quantum change interaction. When we introduce additional photon interactions beyond the ambient background, the nucleus stays basically stable, and the normal first-order world we perceive seems quite stable. This is the first level of physical reality, and it is the reality sensed by our coarse physical senses. However, scalar waves are emitted and absorbed by the nuclei of atoms, passing right through the electron shells without interaction. When we introduce additional scalar interactions beyond the ambient background, the nuclei change appreciably, and this level of physical reality may be far from stable. This is the higher reality, and it is sensed by the scalar electromagnetic functioning of our nervous system. Unfortunately, this system outputs only to the deep unconscious, since it is highly multicellular. Thus our conscious mind, being monocellular, does not perceive the most fundamental reality in which we exist. Note that "time" is the special dimension in which multiple objects can exist simultaneously in the same interval, while space is composed of dimensions (length) in which multiple objects cannot exist simultaneously in the same interval. Time is multicellular, and space is monocellular. Our conscious mind is fitted to the monocellular photon interaction; being monocellular, our conscious mind cannot be aware of time directly. For that reason we do not "see" time consciously. We do "see" it, however, unconsciously. The true meaning of being "lost" is to be separated from the consciousness of the All, which is separation of our conscious, gross sensing of first order reality from our finer, more subtle, and infinitely richer—and unconscious—scalar sensing of ultimate reality.

148. Photon quenching: the effect of photon emission carrying away time, constituting a time-differentiation of spacetime and leaving behind a spatial reality. This action is responsible for the destruction of the time dimen-

sion in the detection/measurement processes of our physical instruments and our body sensory systems. Thus all detections and measurements are spatial, and we detect and perceive only a 3-dimensional spatial universe, not a 4-dimensional or higher spacetime. Photon quenching is thus a filter between us (our senses and instruments) and fundamental reality. Physical reality as detected by our senses and instruments is real, but only partial. Specifically it is a time-differentiation of fundamental reality. We thus lose the ability to detect those things which occupy time but not normal 3-dimensional space—such as mind, thought, etc. Almost all our thoughts, concepts, words, and ideas are fitted to this partial reality—and this is the universal human problem and delusion. We see a spatial universe of separated spatial objects, while in actuality we exist in an undifferentiated single wholeness. It is not a matter of loving one's brother or sister, it is a matter of being him or her. Fortunately, with scalar electromagnetics much finer instruments can be built. The quantal limitation of ordinary physics is not a limitation in scalar electromagnetics. Ultimately we will be able to use sophisticated scalar sensors and biofeedback training to awaken and develop consciousness of our scalar sensing of higher reality, and restore man to his proper state.

149. Piezoelectric effect: In a material, the appearance of a voltage when mechanical stress is applied, or of a mechanical stress when a voltage is applied.

150. Poltergeist: allegedly, a spirit or ghost, often mischievous, usually associated with anomalous psychokinetic activity in houses such as slamming doors, levitating and flying objects, displacement of persons or objects, etc. Often the poltergeist phenomena are associated with an emotionally upset or distraught adolescent. The experience of cooling of the surroundings when these phenomena are evidenced is also common.

151. Potential: locked-in work or energy at a point. It is important to realize that, like a runner running in place, the potential represents work continually being done in time, but at a point, not released through a distance. Since the work is never spatially released, to the external observer it remains in the present as energy, and does not pass into the past as work accomplished! Prior to observation (passage from the present into the past), the physical universe exists as action or angular momentum—e.g., as "energy x time," or "momentum x length," etc. The two variables in which angular momentum is expressed are referred to as "canonical variables." They are locked together, since their product is a constant (in a nonlinear frame). Thus if we ask "what exists in time?" we have asked "what is the time derivative of action, which is the same as "what is existing in time but not in space?" The answer then is energy, which—before observation (separation) exists undifferentiated as (energy x time). Ironically, in electromagnetics the electric (electrostatic) potential is completely misdefined. Most texts start about to define it in terms of "potential difference," and then only tell how to prescribe the intensity or magnitude. For example: "The work which must be done against electric forces to bring a unit charge from a reference point (often at infinity) to the point in question." Note this "definition" does not at all tell what a potential is, but instead tells how to mathematically determine its intensity. Briefly, electric potential is a locked-in stress in vacuum spacetime. This stress at a point is due to the

intensity of the virtual particle (virtual photon) flux (dynamic, ongoing, trapped virtual work) at that point. The ambient local stress of vacuum is not zero, but is a very high value. Normally we refer to "potentials" as measured from the ambient; that is, we actually specify the "difference from the ambient value of the spatiotemporal stress due to virtual photon flux" at the point in question. Any change in the ambient stress of vacuum is a curvature of spacetime. The electrostatic curvature normally stress-relieves almost immediately as electric force field on matter, or electric virtual force field in vacuum. In Kaluza theory, the electromagnetic force fields are just the 5th dimensional aspect of the 5-d gravitational field. The 4-d gravity field is the other aspect of our 4- $\rightarrow$  world's intersection with the 5-d G-field. Thus the electrostatic and magnetostatic potentials are simply two coupled aspects of the 5-d G-field. A normal electromagnetic force field (E or B) is the "bleed-off" or escape on charged particles, of the 5-d gravitational field potential's infolded stress contents into the fifth dimension. That is, it is the 5th dimensional unfolding of the inner contents of the gravitational potential. If we wish to achieve bleed-off into the 4-d G-field instead of the normal 5th dimensional E and B fields, then we must "shut off" the EM bleed-off/out. This shutoff can easily be done by opposing and reciprocally modulating E-fields and/or B-fields so that they lock-together as one field, and vectorially sum to zero vector resultants. This creates artificial (internally structured) electrostatic and/or magnetostatic scalar potentials. These potentials are actually 5-d G-potential, which is now forced to bleed-off/out into the 4-d gravitational force field at great amplification. This is the unfolding of the inner contents of the 5-d G potential into ordinary 4-space. Such an artificial potential produces a vector zeroed 5th dimensional EM system with a deterministic substructure, which polarizes the vacuum and engineers the virtual state. Maxwell's original 1864 quaternion theory included this theory, though not in these specific terms. Heaviside's mutilation of the theory into vectors threw away the electrogravitational aspects by discarding the scalar component of the quaternion.

152. Prigogine crystal: an amorphous pellet or crystal made by sintering finely divided material at high temperature and pressure, in such fashion that the pellet becomes a highly stressed system far from thermodynamic equilibrium. Specifically, more than one type of material must be used, one ingredient of which must be piezoelectric. One ingredient should also be radioactive, and preferably one of the uranium compounds exhibiting highly anomalous magnetic spin coupling. For best results, a third ingredient should be luminescent when electrically stimulated. The stress on each grain of the piezoelectric material must be just so that the grain is on the very verge of being slightly stress cracked, but not split. Each grain then becomes a scalar interferometer. Such a crystal produces a scalar potential field and can react to minute changes in potential—i.e., it can react to scalar waves. Via scalar interferometry it can change scalar waves into negative (time-reversed) electromagnetic radiation and energy at a slight distance. Under oscillating potential stress, the radioactive ingredient provides a one-way gate valve from the Dirac Sea electrons of vacuum, and the scalar interferometers provide necessary impetus on these negative energy electrons to lift

them out of the Dirac sea, producing negative electricity and currents. These currents can then be collected in multiple stages to provide electrical power (negative power operates devices much better than positive power). In the proper arrangement, such a Prigogine crystal can be made into a system capable of tapping the energy of vacuum directly. T. H. Moray built exactly such systems in the 1920's and 1930's, finally obtaining 50 kilowatts of negative power from a 55-lb device. J. Bedini has produced modern versions of these stress crystals in the 1980's, and a series of negative power devices. Several other inventors have produced successful negative power devices also.

153. Prigogine effect: the exhibition of negative entropy by a properly stressed many-particle system far from thermodynamic equilibrium.

154. Prigogine system: a many-particle system which is deliberately forced to exist far from thermodynamic equilibrium, and which exhibits negative entropy. Note that local curvature of vacuum spacetime places the local virtual state flux in nonequilibrium conditions, with the result that an observable energy "sink" or "source" can be produced.

155. Priore, Antoine: French inventor, who invented a large electromagnetic machine which produced nearly incredible cures of terminal cancers in hundreds and hundreds of laboratory animal tests in the 1960's and early 1970's. Priore's results were presented to the French Academy by the Secretary Perpetuel and Head of the Biology Section, M. Robert Courier. The French Government financed Priore's work for several years, then abandoned it when the regime changed. Priore produced complex phase conjugate (time reversed) EM signals in a giant rotating plasma, then sent these time-reversed signals down a rippling magnetic field into and through every cell of the treated body. By magnetic resonance of the rippling field, the phase conjugated signals were coupled into the atomic nuclei of the body, thus reversing the harmful structuring of the cellular biopotentials, which are centered in and on and from the atomic nuclei. This "backtracked" the circulating substructure components within the biopotential, reverting it back to a previous state where the disease was not present. Kindling this pattern into observable state thus reversed and eliminated the disease. (The sharp reader will immediately note that it is readily possible to reverse the aging process, given the development of this technology. So-called "eternal physical life"—or certainly indefinite physical life with youth and vigor—is achievable.) With the death of Priore, the work has ceased and the machine has been dismantled, since no one in the French Academy knew of phase conjugation or understood how it worked. Priore's last machine was nearly four stories high and was intended to treat terminal human cases as well as larger animals such as monkeys.

156. Priore machine: a device built by Antoine Priore in France, which cured terminal cancers and leukemias in thousands of laboratory animals in the 1960's and 1979's. Complex nested modulations were mixed in a rotating plasma, which modulates the signals (producing nested stages of modulations upon modulations, which is necessary to reach into a sufficient number of hyper-spaces/nested virtual levels of vacuum). The device produced very complex, phase conjugate (time-reversed)

hyperspatial signals of some 17 or more dimensions. These time-reversed signals were imposed upon and intense, rippling magnetic field carrier, and induced into the body of the irradiated animal, eventually causing the remission of the disease after several treatments. The signal was able to "work on" some 17 levels of the biopotential. Hundreds and hundreds of terminal cases were cured in laboratory animals. The nested modulations formed hyperspatial, multidimensional components in their "giant photon" vacuum engines. This constituted scalar electromagnetic and virtual state engineering in 17-d spacetime, and the machine directly affected the life force frequency channel (consciousness loop) and master virtual electromagnetic (scalar wave) control system of the cells. It would appear that Priore had worked out combinations of frequencies, etc, that, when expressed in time-reversed waves, reverse abnormal mammalian cells, but do not affect normal cells. With the change in regimes in France and the death of Priore, the large new machine (which would have been used to treat humans) was dismantled and the discovery passed into disarray.

157. Probability: the probability of a simple event is the ratio of the number of times it occurs to the total number of trials (for a large, essentially infinite number of trials). Note that "trials" constitute things that have occurred (are past). Probability has resisted rigorous logical definition by Aristotelian logic; the reason is that it is an expression of the fourth law, the identity of opposites. Probability is the expression of the future (that which has not occurred) in terms of the past (that which has occurred). Since we have been trained to conceive or think of something as if it had just been perceived to occur, then this is the only way we can conceive the future. But with Aristotelian logic, the future cannot be composed of the past, and probability has no acceptable logical basis. With four-law logic, the future can be modeled in terms of—and even be identical to—the past, and probability has a logical basis. Consider "throwing a die to land with one face up." Thinking of the event (as if it has just occurred, in terms of the most recent past), one can conceive six ways of looking at it. In other words, one can conceive of six "most recent pasts." By the fourth law, the total "most recent past" is identical to the "most immediate future," on the boundary. If one therefore collects all six "most recent pasts," they turn into the most immediate future, by the fourth law of logic. One may attempt to argue that only a single one of the events will actually occur. Here one counters with the observation that, when it occurs, it is the past, not the future, and it has not been collected so as to move to the boundary.

158. Problem of change: as stated by Heraclitus: if a thing changes, it must turn into something else. But how can a thing be something else other than itself? The paradox cannot be resolved by 3-law Aristotelian logic, because the concept of change assumes the fourth law (i.e., that a thing can be identical to something other than itself). The problem is resolved (by the fourth law) merely by accounting the time snapshots in which a thing is perceived, detected, observed, conceived, thought, etc. That is, the original thing was perceived in time snap 1. The next thing was perceived in time snap 2. In yet another time snapshot, snap 3, the two previous snapshots are compared (in memory, which is the only place the past exists). If that comparison finds no distinction or differ-

ence between the first two snaps, then they are declared identical (by a decision algorithm). If the comparison in time snap 3 finds a difference between the previous two snaps, then they are declared nonidentical (by a decision algorithm). Most simple macroscopic things are seen as a multitude of composite attributes. Thus one or more of these attributes may be seen to have changed (not be identical between snaps 1 and 2), yet a host of other attributes may be seen not to have changed. In this case, the two overall objects are seen to be "almost identical but not quite," so that one speaks of "the thing having changed." One implies it changes in some attributes, but remains the same in most others. This is the primitive derivation of "how a thing changes, yet remains itself." On the other hand, if one defines a hypothetical thing which has only a single attribute—*itself*—then that thing cannot change, by Aristotelian logic. Yet even such a thing can change! Consider the single overallness of a caterpillar. Let metamorphosis occur, and it is now a butterfly. Now between snaps 1 and 2 we see a different overallness, yet we declare it the same thing! Here we have a more direct application of the fourth law: one thing (snapshot 1) can be identical to another thing entirely (snapshot 2) if the distinction between things one and two is lost in the decision algorithm applied in snapshot 3. In other words, identity and nonidentity are not absolutes, but are products of the decision criteria invoked in determining them. This resolves the age-old philosophical problem of change by expanding the logic by means of which one examines the problem.

159. Problem of good and evil: the paradox posed by the assumption of a "good only" creator moving forward in time, and the simultaneous existence of evil. I.e., if God is perfect and all powerful, how can imperfection exist? This problem is simply one expression of the "time trap." That is, the unconscious assumption of a creator moving forward in time (and "acting" and "operating," for example) is a limitation—hence an imperfection—unwittingly placed on the concept of a creator. Hence an imperfect creator could well wind up with the existence of evil (imperfection) in the creation. If one makes God unlimited—even by time—then perfection may be restored to the creator concept. One then separates a positive time stream and a negative time stream (these are arbitrary, since in ultimate reality all events exist at once, unseparated, and ordering may be accomplished in any fashion one wishes). In the positive time stream, an act then becomes either good or bad, depending on whether it is beneficial or detrimental to its referent. But in the negative time stream the same act is reversed and becomes the exact opposite with respect to the referent. Thus any act is **ULTIMATELY** both good and evil simultaneously, and to the exact same degree. Hence in the "all-at-once" of the unlimited level, the two aspects zero and cancel, and there is neither good nor evil exclusively. Yet there is all good and all evil nonexclusively. The unlimited God is thus both good and evil simultaneously but nonexclusively, and neither good nor evil exclusively. This is the resolution of the unsolved philosophical (and theological) problem of good and evil.

160. Psychic surgery: paranormally opening and closing the flesh of the body to remove abnormal growths or tissues. In a less drastic case, operating on the etheric or subtle energy body, rather than the physical body. In

legitimate psychic surgery, scalar interferometry from the surgeon can nullify the cohesive charges binding the tissue cells together in a line; the tissues then open without cellular damage. When the surgeon closes the tissues, scalar interferometry again restores the charge and cellular binding, so the wound is "healed" without scarring (or with very little, in the practical case).

161. Psychokinesis: inceptive influence or effect upon a physical object, system, or situation by mental intent. Psychokinesis is accomplished by means of scalar anenergy wave patterns projected from the two cerebral halves in the fashion of a scalar interferometer. The waves interfere at a distance, microscopically in the object to be moved or affected, forming microscopic bursts of vector wave energy in the object itself. Jack Hauck has referred to psychokinetic bending of metal as "warm forming."

162. Psychosis: seriously impaired mental functioning so that gross interference occurs<sup>34</sup> with an individual's ability to function in a normal mental fashion. Generally characterized by severe mental disturbance, withdrawal from reality, delusions or hallucinations, regression and personality disintegration.

163. Psychotronic generator: a device which produces observable effects by collecting, condensing, amplifying, and/or processing subtle anenergies or scalar waves. Classic examples are the psychotronic generators of the Czech engineer, Robert Pavlita. Psychotronic devices are virtual state engineering devices that process and utilize scalar EM waves of massless charge flux. Most of Pavlita's devices are "charged" by the natural scalar electromagnetic emissions of the human brain and nervous systems.

164. Psychotronics: *psycho-* (mind energy), *-ronics* (electronics or devices). The union of subtle (mind) energy (that is, anenergy or scalar waves) and matter or electromagnetic field. Czechoslovakian term for parapsychology, with emphasis on the energy aspects. The comparable Soviet term was originally psychoenergetics, which was soon shortened to energetics. However, the Soviets have applied scalar electromagnetics (electrogravitation) principles and massively focussed on weaponry, not just parapsychology. "Virtual state engineering, Electrogravitational engineering, Scalar wave engineering.

165. Pulse mode: in a transmitting scalar interferometer, projection of a single sequential pair of Fourier scalar wave patterns or "pulses", so that the second pattern meets the first over the distant target area. Flash coupling of the two scalar patterns in the target zone produces a single intense electromagnetic pulse (EMP) which—if atmospheric—interacts with the plasma expansion of the atmosphere to produce a second pulse immediately after the first. The dual pulsed flash signature of the scalar interferometer weapon's burst in the target area is very similar to the two-pulsed flash from a nuclear explosion, but without nuclear debris and fallout. Two such pulse mode flashes from a Tesla howitzer—possibly the Russian one at Saryshagan Missile Test Range or one from another nation—have been detected off the southwest coast of Africa by U.S. Vela satellites, one in September 1979 and one in December 1980. Other similar tests have been reported. The pulsed flash may produce positive energy (exothermic) or negative energy (endothermic), depending upon the setup.

166. PulsorR: scalar electromagnetic microcrystal device invented by the electrical engineer George Yao. PulsorsR are specifically designed to correct or smooth the patterns of the subtle scalar electromagnetic "bodies" or levels.

167. Quantum: a single "particle" of the quantity action. The quantum is always composed of two fundamental quantities (canonical variables), and it is the "fissioning" of the action quantum into two pieces which results in detection of one of the pieces. An indefinite "smear" of part of the two pieces may be simultaneously detected by a linear detector, but never both exactly (Heisenberg uncertainty principle). More recent work has shown that, in a highly nonlinear situation, both canonical variables can be determined simultaneously to any desired degree of accuracy, in which case the Heisenberg uncertainty principle does not hold. This fundamental change in what has been regarded as one of the "sacred laws" of physics has not yet made it into most physics texts.

168. Quiton: a little piece of vacuum or emptiness. A piece of the medium of a space or spacetime, of any dimensionality. A piece of pure massless charge flux. A piece of pure scalar wave flux. A piece of pure virtual flux. A piece of the vacuum. A particle of electrostatic scalar potential (infinitesimal charge). A "vacuum engine." Quitons are at least 4-dimensional (spatiotemporal), not just spatial and have a dynamic structure, which may be either random or deterministic. Note that the paper handed to Los Angeles Times reporter Bob Toth by Petukov in Moscow, resulting in their seizure and charging with possession of high Soviet state secrets, contained a theory based on "little pieces of the medium" ("little pieces of vacuum.") In other words, it was a quiton theory, regardless of the specific terminology utilized.

169. Radiant energy: term used by T. Henry Moray to describe the subtle anenergy his amplifier tapped from the unlimited vacuum energy of the cosmos, furnishing usable electrical power of an unusual (negative power) nature. By 1939 Moray was obtaining 50 kilowatts of power from the output of a 55-pound amplifier of some 29 stages, and an additional 50 kilowatts could be tapped off from any other stage. Moray's amplifier was essentially holographic, and could produce exponential amplification to any degree, merely by adding stages. The term was first used by Nikola Tesla, who patented "radiant energy" signaling systems shortly after 1900.

170. Radionics: the use of electrical apparatus (such as ganged precision resistors and potentiometers) to accurately attune the innate psychic and psychokinetic abilities of a human operator. Specifically, the operator may be attuned to some person or object at a distance, through the use of a "witness" (something containing the subtle anenergy pattern of the person or object). In actuality, the pattern contained by the witness consists of the previously impressed virtual (subtle) (scalar) energy patterns riding in and upon the object's internal electromagnetic interactions. The infolded vacuum retains an exact pattern and path of all photon interactions, be they observable or virtual. This guarantees a vacuum path exists between the witness and the original object, no matter where it is located. These impressed scalar EM patterns constitute a sort of complex "tuning fork" attuned to the impressing object or person through hyperspace (via the infolded past "backtrack" virtual memory

of vacuum). Production of phase conjugation waves (time-reversed waves) in the witness thus will result in travel of these waves back through the infolded "back-track paths" to the distant object itself. Resonating the "witness" pattern with amplified anenergy from the operator produces sympathetic anenergy resonance into the witnessed object at a distance, through the hyperspace backtrack path. Since the operator's will and intent modulate and pattern his input into the amplifier, the anenergy resonance of the distant person or object is correspondingly modified. This causes the kindling of an actual microscopic energy pattern in the distant object. The use of amplification constitutes the modern phase of radionics, essentially introduced by T.G. Hieronymus. In the Soviet Union, the incredibly powerful Moray hyperspatial amplifier is believed to be in use in a variety of energetics or psychotronics weapons. Such a holographic amplifier yields exponential power amplification to almost any degree desired. In the destruction of the U.S.S. Thresher in April 1963, a photograph of the submarine was probably utilized as a witness, and sufficient negative energy was kindled into the distant underwater submarine to seriously interfere with its controls. The sub then sank to crush depth and was imploded. Negative energy splatter in the surrounding area so interfered with the electromagnetic systems of the companion ship, U.S.S. Skylark, that over an hour and a half was required to transmit the emergency message that the sub was probably lost. In the U.S., holographic amplifiers have not formerly been developed, and radionics power is limited essentially to the linear amplification abilities of ordinary amplifiers. Thus their gains may reach  $10^4$ , when indeed  $10^{20}$  or so is needed for direct mechanical results immediately. For this reason the West has not developed dependable detectors of subtle energies, has not recognized the Soviet superweapon developments, and has not developed counters to them. However, Bedini, Dea, Beck, Golden, Dayney, Bielek, Bise, and other inventors have built scalar detectors of one form or another. Golden has also produced a highly specialized "booster amplifier"—the Golden booster—for Kelly radionics devices that is a step in the right direction. Both the Kelly machine and the Golden Booster have been verified as scalar wave radiators by actual measurement. With the development of detectors, the technology should begin to develop much faster in the West. The science of such devices and effects.

171. Reality: that which is actual or objective, as opposed to merely possible or ideal. One's idea of what constitutes actual and objective, however, strongly biases what is regarded as real and what isn't. In physics, for example, virtual actions are essential infinitesimals—little pieces of "nothingness" which yet produce effects. Physics thus has extended the meaning of "objective" beyond the idea of "observable." In addition, time—which is never observable or detectable, even in theory—it nonetheless assumed to be real and objective. In a sense, by "reality" one attempts to imply "ultimate." Indeed, the concept is confused, vague, and incapable of definition except in accord with what one pre-assumes it to be! The major problem is that most persons assume (1) reality is limited, and (2) reality is singular. In the new approach, reality is both unlimited and multiple. Everything is real; there are just differing degrees of reality or solidity as compared to the ordinary physical detection



(threshold selection) process. Reality becomes a matter of intersections of physical universes and objects with other physical universes and objects, with the density of the intersection specifying the density or degree of physicality. (Note the similarity to the Aharonov-Bohm effect).

172. Reincarnation: refers to some element of the mind and/or personality surviving the physical death of a body/tuner, and being reborn in the body of another infant. In the new approach, a type of reincarnation is scientifically derived as a consequence of the theory. However, since the past can be changed, by deep developmental work one can actually change one's so-called past incarnations. Also, more than one living person's scalar pattern can be attuned to a similar "past" scalar personal pattern—and so more than one person can be the "reincarnation" of a past person.

173. Remote viewing: the ability of human subjects to receive visual impressions and information from distant actions and scenes. The information is usually "noisy". May involve combinations of clairvoyance, clairaudience, precognition, postcognition, and telepathy. In the new theory, one recognizes that all detection

is internal to the detector. Hence the entire detected physical universe may rigorously be said to exist inside each physical particle of the physical body of the observer. Thus hypothetically one has subtle access to any portion of the universe directly within oneself. The same result occurs when one assumes the use of a signal—longitudinal scalar waves of electrostatic potential—with infinite velocity. The two cerebral hemispheres act as a scalar interferometer, producing microscopic E-field by coupling incoming or rising microscopic scalar phi-field waves. This allows modification of the patterning of the avalanche discharges underway in the brain, and thus perception of the distant event. Since scalar waves are hyperspatial and can be superluminal, they can move through time. This permits perception of the future and the past. Unfortunately the outputs of this detection system in humans is buried deep within the unconscious mind, so it is difficult to obtain "clear signals." With the future development of sensitive scalar wave detectors, biofeedback training can probably be used to more fully develop this scalar sensing ability. Also, on several occasions Nikola Tesla announced the invention of a "big eye" that could see at a distance; such an instrument is perfectly possible by scanned scalar interferometry reception. This would include the ability to see into or through the ocean or earth—and time as well, under the proper circumstances. It should be possible to take distant pictures, or even pictures through time. One researcher, George Delawarr, reported the accomplishment of both these effects with his special camera.

174. Resonance: in physics, an oscillation phenomenon exhibited by a physical system driven by a periodic force; when the frequency of the driving force approaches a natural "free response frequency" of the system, the oscillation of the system becomes large. The "resonance (or resonant) frequency" of a system is a frequency at which some response of the system becomes maximum. Three types may be defined: (1) Phase or velocity resonance, where the response of the system is 90 degrees out of phase with the driving force, (2) amplitude resonance, where the amplitude of response of the system is maximum, and (3) natural resonance,

which is the frequency of oscillation of the system to a sharp input such as a hammer blow. Electrical resonance exhibited by an alternating current reactive circuit results in relatively large currents near certain frequencies, together with the nearly unimpeded oscillation of energy back and forth between potential and kinetic form. There are two kinds, series and parallel resonance. In series resonance, the inductance and capacitance are in series, and in parallel resonance they are connected in parallel. In the series resonant circuit, the currents can become large if the resistance is small. Further, the voltages across the coil and capacitor are essentially 180 degrees out of phase, and so they essentially "cancel," leaving very little voltage across the overall circuit, even when the individual voltages across the coil and across the capacitor are very large. (Note that the E-fields across the inductance and the coil are also 180 degrees out of phase, and so the series resonant circuit to a distant observer produces an artificial potential wave—indeed, an electrogravitational wave. This is one reason why Tesla so favored the series circuit. He also favored it with one end loose—the so-called "single-wire" circuit, without a return.) If the driving voltage to such a single-wire series resonant circuit is applied to the coil with the open-ended capacitor beyond, and the voltage is applied for only the first 90 degrees as a sine wave then instantly removed, the coil will be charged without current flow, accumulating a 5-d gravitational potential. When the coil discharges, it will discharge in two directions, producing real current, at a certain frequency (which may be drastically different from the "normal electrical current" resonant frequency. However, actual current will be induced out of both ends of the coil at this frequency. The capacitor will charge a little bit from this effect. The overshoot of the coil discharge back toward the disconnected driver is also usable energy if connected to a proper load. If the load is removed and the driving voltage is reapplied just as the overshoot reduces back to zero, the cycle is repeated, charging the distant capacitor more and more, and producing pulses of usable power through the overshoot discharge on the driver side. By adapting this mechanism, a free energy motor can be readily produced, as demonstrated by Bedini, Watson, and others with a battery-driven, series-wound DC motor unit. Note that use of the localized gravitational potential produces local general relativity, a locally bent spacetime, and the conservation of energy, charge, and momentum laws need not rigorously apply. An adaptation of this mechanism was also utilized by Tesla in his magnifying transmitter. In that transmitter with its huge elevated capacitance, the artificial potential wave produced would have been introduced into the earth, producing scalar resonance of the earth. The molten core of the earth, being under pressure in all directions, is self-pumped (in the language of nonlinear optical phase conjugation). The resonant atomic nuclei of the earth's molten core would then act as a pumped phase conjugate mirror (PCM), producing a highly amplified (near infinity gain!) time-reversed wave in response to the input signal. Thus the earth PCM is a giant amplifier, and the TR wave returned is highly amplified, possessing enormous energy. Thus the amount of energy resonant in the earth becomes enormous. In fact, the transmitter was designed to produce more than one such scalar earth resonance. At any distant point on the earth, a transmitter/receive station could have input a

small "tickler wave" at this frequency into the earth, and its proper antenna tuned to the frequency" of the scalar resonance would have produced enormous electrical power. A very similar system employing two frequencies 12 kilohertz apart and tapping the beat frequency, is used by the Soviet Union today to power its large strategic Tesla weapons. Golden has detected and shown these Soviet "two-frequency earth resonances" on the oscilloscope, utilizing the output of his specialized detector system.

175. Sasquatch: Indian name for a large, well-defined tulpoidal apeman form. Bigfoot (slang or common name). Generally refers to the Pacific Northwest area, where die tulpoidal form has been well-tuned for centuries by the Indians. In the Far East, the Yeti.

176. Scalar: in ordinary vector analysis, a quantity completely characterized by magnitude only. (Actually, it contains magnitude and time.) In the new approach, one must account for observable and virtual states. In addition, multiple vectors acting on one point and summing or multiplying to zero are physically still present, even though their vector resultant is a zero vector (more precisely, a zero-vector system). Thus physically a zero vector can be a system having a very real, distinct substructure of nonzero vector components. These infolded vector components may be highly dynamic. The energy of each infolded dynamic vector component is thus "trapped" inside the local vector zero system. Rigorously, trapped energy constitutes a scalar potential in spacetime, to the external observer. An observable scalar (potential) thus may have a nested, multiple-level virtual substructure as well as any conglomerate "observable vector" substructure. Enormous energy may be infolded and trapped, in which case local spacetime is appreciably curved. Note that the infolded energy of the substructure components contributes to the stress of the object or medium, and organizes it, even though to the external observer its envelope constitutes a zero vector. Each level of this substructure contains an infinite number of tiny virtual vectors. There may be finite alignment of these virtual vectors along the structure of the observable vectors infolded. This constitutes vacuum polarization. The zero-vector system is thus a vacuum engine and a virtual state engine as well. Two scalars (or vectors) that are observably equal need not be equal at all in their substructures. Further, combining the two scalars by superposition may not yield the normal observable value, if both substructures are different, highly patterned and interact to spill over into the observable level. Vector mathematics itself must be changed and extended in the new approach. Note that the spillover from interaction of the two substructures may form an observable scalar value or an observable vector value. Such vacuum engines can be constructed to do specific operations on atomic nuclei etc. Nested levels of such engines can be formed, to form highly complex "super" hyperspatial vacuum engines called giant photons. Continual radiation of matter with a signal composed of vacuum engine photons of a specific deterministic substructure will "charge up" the atomic nuclei of the radiated material with that pattern, so that it emerges into the gross, observable physical state, drastically altering the radiated matter itself mechanically, chemically and physically. This process is called kindling.

177. Scalar energy tap: refers to a Soviet method of ob-

taining tremendous electromagnetic energy from the molten core of the earth, with which to power gigantic strategic scalar Tesla howitzers. As measured by Golden, two signals are continually transmitted into the earth some 12 kiloHertz apart, and the earth itself is placed in scalar resonance to the two frequencies. The core of the earth, being a pumped phase conjugate mirror, responds by generating highly amplified phase conjugate replicas, which return and concentrate all their energy at the transmitter/receivers. The receivers receive the enormous beat frequency (12 kHz) energy, using it for power. One then has a kind of scalar interferometer channel in the earth's core in the endothermic mode. Depending upon the biasing, either ordinary EM energy or negative EM energy is captured in the 12 kiloHertz band by the interferometer receivers. Varying the negative biasing also provides a throttle to control the amount of energy extracted. Just before the May 1, 1988 celebration, the Soviets activated some 27 such giant energy taps in the earth, and also activated a large number of command and control scalar transmission frequencies. If each tap can power 6 to 8 giant Tesla howitzers, then for their important 40th anniversary of WWII, the Soviet Union activated well over 100 large howitzers. In other words, a massive exercise of the Soviet Union's entire strategic scalar howitzer weapon complex was held on the 40th anniversary of 1945 for Gorbachev, and to signify meeting the schedule (laid down by Brezhnev in 1972) to "be ready" to use them. At the conclusion of the exercise (which lasted several days), the Soviets left two scalar energy taps in place, instead of the single one present before the exercise. In other words, additional strategic weapons were brought up on "ready alert"

178. Scalar field: in vector analysis, each point in space is assigned a magnitude; the set of spatial points and their assigned magnitudes is called a scalar field. In the new approach, an observable scalar value is assigned to every point in n-dimensional space, where n is 4 or greater, and the set of n-dimensional points and their assigned observable magnitudes is called a scalar field. Also, in the new approach each scalar magnitude is considered to contain an n-dimensional virtual-state substructure, where each succeeding higher dimension is a succeeding lower level of virtual state. Vacuum itself is such a scalar field. Such a scalar field is also the rigorous identity of a massless charge field, of—for example—the electrostatic scalar potential, 0. Also, the scalar field is considered to be composed of two time fields: one in positive time and one in negative time that is the phase conjugate replica of the first. Thus the timeless, lengthless vacuum exists both in positive and negative time, and its potentials are scalar potentials. When the vacuum is uncurved, equal amounts and components of positive and negative time exist. When it is curved at a point, the positive and negative time components are unbalanced at that point

179. Scalar interferometry: the interference of two scalar Tesla waves (a Tesla wave consists of a normal wave coupled to its phase conjugate replica). In the interference, coupling can occur and produce (or extract) electromagnetic waves—energy—at a distance. The phase conjugation aspect is the secret of Tesla's revolutionary discovery of wireless transmission without loss. It is also the secret of producing death rays; the invulnerable Tesla shield; antigravity; superluminal communication; con-

trolled materialization, dematerialization, and transmutation; psychokinesis; and free energy. The ubiquitous photon interaction presently is the basis for first-order physical reality, and the photon's speed results in a speed-of-light-limited reality being detected. Scalar EM waves contain vacuum engine substructures and do not necessarily have this speed limitation. Detection by scalar waves yields a higher order physical reality and a vastly expanded quantum mechanics and relativity theory. Present Einstein relativity theory is only a highly special case, as are present electromagnetics and quantum mechanics. Soviet use of scalar interferometers in a large, strategic mode is responsible for much of the advanced Soviet ABM defense and strategic super-weaponry.

180. Scalar resonance: inertial or mass resonance of a body, originally discovered by Tesla, repeated (probably) by Hooper, and rediscovered by Golden, Bedim, and others. In the simplest case, scalar resonance can be imagined as two ordinary single-frequency EM standing waves (a wave and its phase conjugate replica or PCR) in a resonant cavity, with the two waves coupled exactly 180 degrees out of phase so that—externally—their E fields sum to zero and their B fields sum to zero. This is a standing scalar wave, and the cavity is said to be in scalar resonance. Note that the cavity walls must act as phase conjugate mirrors (PCMs). Mass itself is simply such a standing scalar resonance, with the standing wave trapped by particle spin. The atomic nucleus, continually bombarded by virtual photon flux from the vacuum, is a pumped PCM. Since the nucleus is positively charged, it produces PCRs having negative energy and negative time. It thus produces negentropy, which prevents the entropic decay of the atom. Essentially all frequencies can be and are present at once, but certain nuclear resonance frequencies are thought to predominate. By increasing the amplitude of the standing scalar wave that is the nuclear pseudopotential, inertia and mass of the nucleus are increased. By decreasing the amplitude, the mass and inertia are decreased. Zeroing the amplitude dematerializes the nucleus. Scalar resonance is not presently contained in the orthodox physics literature.

181. Scalar wave: a longitudinal "pressure" wave in the actual stress of spacetime itself. A wave of potential, where no EM bleedout of the infolded contents occurs. A normal wave and its phase conjugate replica, comodulating each other and "locked or zipped together" as a zero-vector system wave. A Tesla wave. A gravitational wave. A time wave. Electromagnetically, a scalar potential wave which, in the absence of spinning charged mass particles, does not form a vector electromagnetic wave, in contradistinction to present electromagnetic theory. A "shadow vector" wave, where the ordinary "observable force vector" of the field is broken into virtual vector components which are not integrated. A wave in the nested levels of virtual state, that does not breach the quantum threshold, and hence is not observable to normal detectors. A wave in the magnitude of the virtual particle flux density of vacuum. A longitudinal wave in pure massless charge flux (vacuum) (spacetime). A wave in the magnitude of the infolded "energy density of the vacuum. The scalar wave is free to move in four or more dimensions. It transports deterministic vacuum energy engines. In Minkowski 4-space, it can: (1) move only in time, and not spatially, in which case it "sits in one

place' and fluctuates the flow of time, the inertia of an object, the strength of the gravitational field, the mind, the fundamental constants of nature, etc.; (2) move only spatially, with the rate of flow of time oscillating about a linear mean; (3) move in a mixture of modes (1) and (2); (4) oscillate back and forth between modes (1) and (2) in a regular fashion, spatially stationary; and (5) oscillate back and forth between modes (1) and (2), translating spatially in travelling wave fashion. (5) move and oscillate between many vacuum levels (hyperspaces), in addition to characteristics (1) through (4). An ordinary Hertzian wave exists in vacuum as two coupled Tesla longitudinal waves. Rigorously, the E and B fields do not exist in vacuum, but on and of the detecting spinning charged particle. The spin of the detecting particle causes precession, yielding the familiar "transverse Hertzian wave," complete with E and B fields. The broken but ordered virtual state bits of what will be the detected E and B, however—shadow vectors E and B—exist in vacuum, on the virtual components of the vacuum charge flux. Tesla was correct when he stated that transverse Hertz waves (as such) could not move through the vacuum or exist in it

182. Shadow vector: an otherwise observable vector, broken into consecutive bits such that each bit is virtual. The resulting "disintegrated vector" becomes unobservable as a vector, but remains as an ordered series of virtual vectors. Thus it is a special sort of scalar wave. Observably, it is a scalar wave since no observable vector exists, but virtually it is a vector wave. It may be regarded as a localized, changing scalar field with a particular patterned virtual substructure which yields the shadow vector. On an appropriate integrating detector, the virtual components of the shadow vector will be reintegrated into an observable force vector, such as E or B. Dr. Robert Beck, for example, has reported the development of a successful integrating detector for such shadow vector scalar waves. His detector is capable of detecting signals that cannot be seen by the finest Superconducting Quantum Interference Device (SQUID), and it has been demonstrated for comparison against the SQUID. Dea, Bedini, Dayney, Golden, Beck, Bielek and Bise have independently built scalar wave detectors of various kinds. Farnsworth has particularly good and comprehensive shadow vector/scalar wave detecting systems.

183. Space: literally, the absence of observable mass, hence emptiness or void observably. Space per se has no definite length interval and no definite time interval. Rigorously, space is the absence of distinction and separation. Space has no dimensionality—i.e., it is not 3-dimensional, 4-dimensional, etc., for it has no "specific" separations. But in common usage, it is often thought of in a general sense as having some particular dimensionality but no definite intervals. The point is subtle but important: the absence of a 3-dimensional mass need not be 3-dimensional (e.g., considering a 10-dimensional frame). But one usually thinks of the "hole" where the mass was as having the same dimensionality as did the absent mass. This is only a 3-dimensional intersection of the actual hole, however, though this point is usually ignored. Ignoring the full dimensionality of a hole is responsible for the confusion regarding the two-slit experiment in quantum physics, for example. That is, the slits are (at least) 4-dimensional, since they exist in time also. In the slits, spatial mass is absent, so the slits are

three dimensional "holes." However, their fourth dimensional aspect, time, is present, not absent Thus four dimensionally the three-dimensional slit "holes" are not "holes", but are "things." They are not 4-d absences, but presences—since one dimension (time) is still present They can thus interact in the fourth dimension, time. The experiment has no mystery when the time aspects are considered, as pointed out by Charles Muses in 1957. In Kaluza-Klein 5-d mathematics, these 3-d holes also exist as things in the fourth spatial dimension. Also, in spacetime—rigorously—all 3-dimensional material objects, holes, gaps, etc. are simple facets or intersections of a single object For if time is considered as a continuum, then everything exists at once; hence spatial things are simply the features of a single 4-dimensional object The problem is that "space" is also commonly taken to be a "spatial frame," where time has been stripped off and "stopped," and a measurement to each and every point in the universe frame has been simultaneously established. This corrupt usage of "space" implies "spatial frame," and is entirely different from space as such.

184. Spacetime: three or more dimensions of space and a dimension of time, multiplied together. In the 4-dimensional case, it is often referred to as a "4—space." Spacetime can actually contain any number of dimensions; in our theory we consider an infinite number of spatial dimensions and at least one time dimension. One could just as easily take an infinite number of time dimensions alone. Scalar electromagnetics (unified EM and G fields) is most easily expressed in Kaluza-Klein geometry, in at least five dimensions—four of space and one of time.

185. Spherical model of the cosmos: a model of the universe in which the universe is a four-dimensional spherical surface in five dimensions. This results in a "closed" universe, and also one which is entirely within each point of itself. To produce such a model instead of an expanding universe, Einstein originally introduced entirely ad hoc factors into general relativity to cancel and eliminate the expansion terms.

186. Spin: the intrinsic angular momentum of a particle, as if it were a top spinning about an axis. Spin is quantized. Spinning charged particles—such as an electron—thus demonstrate a magnetic moment, due to the circulation of charge in the spinning. In the nucleus of an atom, the spin of the nucleus is the resultant of the spins of the nucleons (particles comprising the nucleus). Actually spin of particles is more like an "implosion" to "explosion" circulation; in other words, it circulates in time as well. Spin of a particle is the basic feature that integrates the anenergy (disintegrated energy) of vacuum flux into observable charge. All observable fields, matter, effects, etc. depend upon this basic mechanism to zip together virtual entities and form observable phenomena.

187. Spooklight: another slang name for a nocturnal light Legend and folklore usually associate it with a violent death or macabre occurrence. Earth stress lights. Over 1,200 known sites produce such earth stress lights in the U.S. alone.

188. Strobe effect: striated patterns seen in UFO and other paranormal phenomena due to the higher dimensional phenomena skipping in and out of normal 3-space. Alternatively, two or more higher dimensional phenomena may dynamically interfere so as to form repetitive intersections with our normal 3-space, produc-

ing striations. Hyperspatial (scalar) EM interference often produces striation effects.

189. Substructure: in the new approach, a scalar has an infinite-dimensioned (infinite number of sublevels) virtual state substructure, filled with waves, particles, etc. Vacuum has precisely the same sort of substructure. The substructure is rigorously CHARGE FLUX, where observable mass is not present. Any vector, since it contains a set of scalars, also contains a set of virtual state charge flux substructures. One can engineer, pattern, arrange, and utilize these substructures to give various "paranormal" effects. These effects include materialization and dematerialization, psychokinesis, clairvoyance, superluminal communication, antigravity, teleportation, apportionment, remote viewing, production of energy at a distance, extraction of energy at a distance, electron dissolution, etc

190. Superposition: the simple linear addition and subtraction of two or more values. In the new approach, superposition need not linearly hold valid if sufficient substructure interaction is obtained and the substructures are nonlinear. In that case, superposition turns into nonlinear interference.

191. Teleportation: the transmission of an object from "here" to "there" with no travel in between as an object in ordinary space. Hyperspatial transmission of an object from one point in the ordinary space to another.

192. Telluric currents: earth currents; electrical currents in the rocks of the earth, believed to be due to aurora effects and the earth's magnetic field. In the new approach, these currents are also pumped by longitudinal scalar wave bombardment from the sun, the cosmos, and the fiery core of the earth itself. Quartz is a common crystalline component in rocks, and thus the rocks are piezoelectric This means that stresses in the rocks, such as from shifting tectonic plates, causes electrical activity, and electrical activity causes mechanical stresses. Further, the quartz is essentially randomly oriented, resulting in most of the tiny piezoelectric vectors summing to a vector zero, which in turn constitutes a scalar potential and pumping the atomic nuclei as pumped phase conjugate mirrors, producing PCR waves. These do the same thing in return, producing negative energy potentials and potential waves, etc. As the piezo-vector components vary, the values of the potentials fluctuate. The zero-sum portion of such a stressed randomized crystal constitutes a Prigogine detector for kindling and collection of anenergies via nonlinear thermodynamics. The molten core of the earth is also a dynamic Prigogine system, since it is a pumped PCM. Thus the earth is a collector, processor, sometimes amplifier, and retransmitter of mind energies and anenergies, and truly the earth may be considered to be "alive" in a strange way (the Gaia hypothesis). This process, along with scalar EM in living systems, also produces Sheldrake's morphogenetic field and its effects. Specifically, the earth receives and processes anenergies from the species unconscious of all the species of ordinary life upon it The earth itself does respond to geometric kindling alignments of other planeti. and particularly to the moon. In addition, it does respond to the state of man's collective species unconscious mind. Fault zones result in structures similar to diodes, triodes, and scalar interferometers. Amplification and rectification of kindled anenergies occur readily, including at a distance, at fault zones, particularly when

seismic stresses in the rocks are increased, increasing the piezoelectric activity, telluric currents, scalar interferometry, etc. Thus fault zones constitute natural kindling window areas for paranormal anenergy forms, for tulipoids etc—precisely as found by Persinger. Fault zones are also scalar interferometers, which enhances the formation of ordinary EM forms at a distance.

193. Tesla fireball: interference of two scalar Fourier expansion patterns to form a glowing, fiery globe or spherical shell of radiant electromagnetic energy and electron plasma.

194. Tesla howitzer: a large Tesla scalar interferometer such as the fourth generation Soviet hyperspatial howitzer at Saryshagan. Repeated Soviet testing of Tesla howitzers is documented in the open literature (see Bearden, *Fer-de-Lance*, Tesla Book Co., 1986). The howitzer is capable of utilization in multiple modes, both as a strategic offensive weapon and as a multiple-mode strategic ABM defense weapon. Scalar EM interferometer. Hyperspatial howitzer.

195. Tesla shield: a gigantic, hemispherical, glowing, thin shell of intense electromagnetic energy and electron plasma, placed over a defended area or installation. The EM shell is formed by interference (and coupling) of two scalar shells of anenergy, formed by truncated Fourier expansion methods from multiple frequency scalar transmitters. To form the shell at a distance, phase conjugate replica waves must be utilized, so that the energy and energy pattern does not diverge as a function of distance. Note that such real-time holography, independent of distance, already appears in the nonlinear optics phase conjugation literature. In the Tesla Shield, the energy density in the interference shell causes local curvature of spacetime, and lifts electrons from the Dirac sea, producing the plasma in the shell. With sufficient energy density in the interference shell, a material object seeking to penetrate this dome of energy and plasma is instantly electromagnetically "dudded," and physically damaged and/or vaporized. In addition, the potential pulse delivered inside the nuclei of nuclear materials that meet the shell instantly fission all fissionable materials. Thus nuclear weapons are instantly detonated when entering the shell. Electromagnetic energy (such as gamma radiation from the EMP of a high altitude penetration burst) impinging on the shell plasma is absorbed and re-radiated inside the shell at lower frequency and temperature. Several shells may be interested so that multiple, serial absorption and scattering reduces the original gamma radiation to harmless radio frequency noise. Numerous incidents of tests of the Tesla Shield weapon are documented in the open literature.

196. Tesla wave: a longitudinal scalar potential wave in massless charge, in the vacuum charge flux itself, and in pure spacetime. An electrogravitational wave. A gravitational wave. A scalar EM wave. A wave of pure potential. A wave in the magnitude of the flux energy density of vacuum. A wave in the magnitude of the curvature of vacuum.

197. Tesla weapon: any weapon utilizing longitudinal scalar EM waves or phase conjugate replica waves to accomplish its results. Also applies to a weapon using scalar interferometry or PCR interferometry and holography from multiple projectors or transmitters.

198. Thought: separations and forms in pure mind or being. To think is to form (separate, perceive) thought

forms and process them. In a developmental sense, thinking is the activity of mind that screens the true continuous mind nature by fragmenting it. The true mind is like the ocean, and thoughts are like waves or disturbances in the ocean. In the new scalar electromagnetics, the mind itself produces scalar waves, on the third and lower virtual levels of the scalar substructure, and these are what we call "thoughts." A thought is a real, virtual-state object capable of being directly detected, interacted with, and engineered by scalar EM means.

199. Thought photography: psychokinetic impression of images or light effects upon photographic film or other sensitive media, due to the presence or intent of a human initiator. PCR distant interferometry and holography is the basic mechanism involved.

200. Three-space (3-space): a space dimensionally composed of length cubed. It is the normal space taken to be occupied by gross matter. Per se, vacuum does not occupy this same 3-space, even though erroneously assumed to do so in present physics.

201. Time: in relativity, an extra dimension (variable) which allows the ordering of spatial snapshots or events. In quantum mechanics, time is only a parameter; it is not an observable and is not detectable, even in theory. Time is always inferred, even though precisely. Rigorously, time exists only through the stream and persistence of human consciousness. We only experience that persistence as "something changing", by continual comparison of our memory of perceptions of spatial position and pattern. In the abstract sense, time is being, which has no differentiation whatsoever—it simply is (a tautology). Perceptual separations in being constitute thoughts or mind changes, much like waves in water. Those waves common to all minds constitute physical (spatial) changes in the so-called "real" world. Because "time" in its undifferentiated sense is simply a synonym for being, then multiple things (separations) may inclusively exist in time simultaneously. (How many final objects exist in a stone before it is carved into any one of them?) The basic separator of being/time is the photon interaction, which is the basic generator of monoclonal quantum change and thus the progression of spatial particles "through time" in little jumps. The endpoints of the quantum jumps through time represent time differentiations of spacetime/masstime. To properly understand physical phenomena, both positive and negative time flow must be incorporated in the theory or model used.

202. Time oscillation: ordinary time advances and retards in small discrete jumps, much as a sewing machine stitches forward—except that each time stitch is pulled out before the next one is made. Thus time consists of two time flows interleaved: the positive flow of time (stitching) and the negative flow of time (unstitching). This "time stitching/unstitching" or oscillation can be viewed as a wave. It is "action" that is waving (being changed or created and destroyed in quantum chunks), since time is actually a subcomponent of action. One may therefore view time waves as carrying or creating surges of energy back and forth (in time). The photon may be considered as this oscillation of time, for it is actually an oscillation of action. The positive half of a photon exhibits positive time (the stitch is made) and a virtual electron, and the negative half exhibits negative time (the stitch is removed) and a virtual positron. Charge is a function intimately related to, and comprised

of, time stitching. Positive time is associated with negative charge, and negative time with positive charge. The photon can be considered as a coupled virtual electron-positron pair. The invisible stitching/unstitching trace of a photon through space is "enfolded" (in time) and remains. A phase conjugate replica photon, created at some later time and some distant place, thus has a sort of "invisible wire" connecting its own generation and the distant source that generated the stimulus photon. Note that spacetime occupies time, but space does not. Mass-time occupies time, but mass does not. Mind, thought, and being occupy time, but not space.

203. Time trap: refers to the erroneous assumption that God is a limited being, traveling along through time much as humans perceive themselves to. An unlimited creator must permeate all aspects of creation, including time. In the unlimited view, God permeates time from beginning to end, all at once. To such a creator, nothing is happening, since all happenings are simultaneously present. What we call "positive" or forward time and "negative" or backward time co-exist and are inseparably identified, to such a level. Good and bad are only relative to a single time stream and to a single referent. At the unlimited level, there is no separate good or separate evil. Yet there is all inseparable good and all inseparable evil. All "events" or acts that one might separate, simultaneously exist in both forward and backward time streams. Hence any event is ultimately both good and evil simultaneously, and to an identical degree. Again, this is the void that is devoid even of void.

204. Transverse wave: a wave which vibrates laterally to its motion in a medium, exactly like the vibration of a stretched string. Vector electromagnetic (Hertz) waves are transverse waves, in the present theory. In the new approach, transverse waves cannot exist as such in vacuum, but only in a longitudinally restrained medium. (The electron gas in a solid conductor, for example, is such a medium, and Maxwell's equations rigorously apply to the transmitting electron gas and to the detecting/receiving electron gas, but not to the vacuum in between.) Longitudinal (alternately densifying and rarefying) scalar waves exist in vacuum, in the charge (virtual particle) flux that vacuum identically is. Hertzian waves in vacuum exist as shadow vector waves, that is, as two or more coupled Tesla scalar waves spinning around each other.

205. Tulpa, tulloid: condensed, materialized or semi-materialized thought form, either living or inert. May be a visible or an invisible electromagnetic form, a partially materialized form, or a completely materialized form. Ultimately all matter and fields are tulpoidal in nature, consisting of condensed thought/mind energy.

206. Two-slit experiment: a form of Young's experiment where a particle is generated and directed toward a plate having two tiny slits (holes) in it, with a collection screen or device on the far side of the plate to collect and add the impacts of the particles that pass the plate. The idea is that a classic corpuscle can only go through one hole at a time, like a baseball through a hole in a fence. For particles, classically the strikes on the collector screen should be grouped in two clusters, each representing a straight-line passage through one of the slits. In the experiment, however, the particle strikes form a wave diffraction pattern when collected on the screen, unless the emitted particle is struck by a photon before it

strikes the screen. In the latter case, the two clusters for classic corpuscles are observed. The experiment—fundamental to all quantum mechanics—is simply understood if one considers the time aspects of the problem, as pointed out by Charles Muses in 1957. The two slit apparatus with electrons may be also used as an electron interferometer for sensitive detection of scalar EM (electrogravitational) waves.

207. UFO: unidentified flying object Any object or light in the sky that cannot be identified as an ordinary physical phenomenon. After normal objects and phenomena are eliminated, the remaining paranormal residue is of interest. Many of these are kindred tulpoidal forms, and may consist of lights, invisible electromagnetic energy, physical objects such as discs or spaceships, robots, humanoids, etc. (A few of these forms may be real anti-gravity spaceships, created here on earth by sensitive groups of several earth governments, but controlled by some mysterious group outside these governments. Such craft, I believe, have been developed and flown all over the solar system since the early 1950's. These I do not consider part of the true UFO phenomena, which in one form or another are centuries old.) Highly materialized ship forms may also contain highly materialized living forms such as space-suited astronauts etc. The "UFO" has been separated from other tulpoids (bigfoot, fairies, spooklights, water monsters, etc.) because its appearance in the sky was immediately associated with aircraft or spaceships, leading to the initial expectation that extraterrestrials in advanced spacecraft were visiting the earth. Most of the UFO phenomena actually consists of lights at night (well over 80%), and only about 6% or so resemble well-materialized ships with astronauts. A substantial portion of the "lights at night" phenomena are also due to Soviet scalar EM interference weapons. The Soviets create a great deal of light phenomena worldwide, to spark UFO reports, which are discounted by conventional science and most of the military and government agencies. This provides the Soviets a giant and effective "deception plan" so that the weapons can be tested and readied worldwide, and sightings and reports will be discredited and not cause undue alarm.

208. Unconscious: unaware, not conscious. Refers to that part of the individual's mind which is not normally in conscious awareness, but which may contain a great deal of material from the conscious mind. In the new approach, the unconscious mind is considered to be "multiply conscious," while the conscious mind is considered "singly conscious." In other words, the unconscious is a "parallel processor," while the conscious is a "serial processor." Unconscious should be thought of as not singly conscious, but multiply conscious. Further, this allows a totally new idea: Multiple singly conscious, different minds coexist simultaneously in time, though not in the same "3-dimensional mindspace." Suppose we consider a set of  $n$  such singly conscious minds. All the minds exist in a spacetime of dimensionality  $3n + 1$  ( $n$  is the number of different conscious minds in the set, and an additional dimension, time, is common to all minds in the set). Thus the considered set of singly conscious minds constitutes one multiply conscious—or "unconscious"—mind. In this way one may speak of "levels of unconsciousness" in relation to groups of persons, with the deepest level being and containing every human mind. Of course the analogy can be continued to yield

the higher minds or consciousness projected by Teilhard de Chardin. In the collective human unconscious, those forms which are in each and every mind are the archetypes discovered by Jung. In a shallower level, other forms may be common to that level, constituting "weak archetypes" or "fragmentary archetypes." There is considered to be no limit to levels of unconsciousness—the ultimate depth being "all consciousness" (and all unconsciousness!) of Godness. God must be able to both be and not be at the same time; if God cannot do that little trick, then God has a limitation and is not unlimited.

209. Vacuum: pure virtual particle, massless charge flux. The virtual state, or ether (nonmaterial, Lorentzian). Lengthless, timeless spacetime itself. That state where everything is disintegrated, but highly dynamic. Note that vacuum is not an emptiness FILLED with massless charge, rather, it IS identically massless charge (disintegrated dynamicism). It is a plenum, not an emptiness. It is also pure action, undifferentiated. Einstein once suggested that the vacuum, complete with its electromagnetic and gravitational fields, should be taken as the ether. In the modern view, the term ether is again accepted in the literature, but now it refers to a "virtual particle flux" ether, not a thin material ether. One can model the vacuum analogous to a special kind of virtual-particle gas: one in which the particles "appear" and "disappear from and into nothing, nearly instantly, so fast that they cannot be individually detected. Thus the modern idea of the vacuum is a seething inferno of fiercely bubbling, fleeting particles. The other limitation is that the dimensionality of the vacuum is not fixed until operations are invoked, and neither is the rate of passage of time. Thus the vacuum has no fixed lengths nor fixed rates of time flow per se. One can visualize the stress of vacuum as a sort of conglomerate potential "pressure," where the individual stresses of various types of particles, if integrated by some external means, would sum into the overall stress (pressure). Variation of the "stress of vacuum" between two points in a frame represents a "curved spacetime" or "accelerated frame." Note that overall stress can be held constant, while two or more different components are canonically varied. The electrostatic potential, the magnetostatic potential, and the velocity of a charged particle are three such "canonical" variables. If the overall "pressure" is not varied, the three variables are canonical and energy, momentum, and charge are conserved and one cannot build a perpetual mobile (perpetual motion machine). If the overall "pressure" is varied between local points in the frame, then the conservation of energy, momentum, and/or charge need not rigorously apply between those local points. At any one point, one may have a "free source" or a "free sink," depending on the vacuum curvature and the EM standing wave relationship. In that case, one can build a local "perpetuum mobile," since one can tap a "free source." Einstein created a severely restricted general relativity (GR), where he assumed away any local curvature of vacuum. In the West such a severely restricted GR is still dogmatically enforced, because it "saves" the conservation laws, which are regarded as sacrosanct. In Soviet physics journals, learned papers by leading scientists are regularly published in which unrestricted GR—including local curvature—is developed and explored. In a local curvature region, the Soviets have already pointed out that any and all conservation laws may be violated. The

Soviets have long since developed and weaponized unrestricted GR, while our scientists are still dogmatically insisting that one cannot deterministically engineer local curvature of spacetime. Thus we maintain our obsession with conservation, and the Soviets maintain the weapons.

210. Vector: in mathematics, an entity completely characterized by a magnitude and a direction. Abstractly, vectors are considered to be formed by a difference in potential between two spatial points. In the new approach, vectors are characteristics of particle motion, and do not observably exist in the absence of a particle. Since all detectors have mass, and this mass contains spinning charged particles, then force vectors are constituted on and of the spinning charged particles. In the vacuum, only an unzipped (disintegrated) vector pattern exists—or, as Feynman put it, only the potential for a force vector exists there. Maxwell's original theory was written in quaternions. In 3-space, a vector has the familiar three components, say,  $ai + bj + ck$ , where  $i, j,$  and  $k$  are the usual  $x, y,$  and  $z$  unit vectors, and  $a, b,$  and  $c$  are the magnitudes of the  $x, y,$  and  $z$  components of a vector. A quaternion, however, has an additional scalar component—say,  $w$ —so that it looks like  $w + ai + bj + ck$ . Maxwell's original theory actually unified gravitation and electromagnetics! When vector zeroing operations occur, the quaternion may not zero out the scalar component. As an example, consider the cross product of a vector  $A$  with itself,  $A \times A$ . In vector analysis, the resulting vector is the zero vector. In quaternions, however,  $w$  remains, and  $w = a^2 + b^2 + c^2$ . With the correct proportionality constants,  $w$  therefore represents the energy density of vacuum due to the two zero-multiplying vectors  $A_1$  and  $A_2$ , where  $A_1 = A_2$ . To recover my scalar wave or gravitational wave: Now let the vectors  $A_1 - A_2$  where each is the E-field vector of an identical EM sine wave. (That is, we perform a device which accepts two identical input EM sine waves and performs a cross multiplication. That device, e.g., may simply be a special kind of nonlinear modulator/mixer.) In ordinary Heaviside/Maxwell theory, the EM output of this operation is a continuous zero vector, and that's all. However, by Maxwell's actual theory, the output of the operation is a scalar EM wave, whose amplitude varies as the energy of  $A$ . That is, the operation produces a scalar EM wave which is varying the energy density of vacuum. By definition, that is a gravitational wave. Since it was produced electromagnetically, I refer to it as an electrogravitational wave. It was included in Maxwell's original 1864 theory. After Maxwell's death, Heaviside and Gibbs completed the modern form of vector analysis. Heaviside—a single man—then "translated" (mutilated) Maxwell's theory into his new "vector" theory. He simply sawed off and discarded the troublesome scalar component of the quaternion! That made calculation a whole lot easier, and easier to understand. In discarding the scalar component, he discarded electrogravitation, writing an EM theory that specifically excludes local curved spacetime and gravity. Before the turn of the century, a short debate involving only about 30 scientists resulting in the complete adoption of Heaviside's mutilated version of Maxwell's theory. Quaternions and quaternion theory—and electrogravitation—vanished from the literature and the textbooks—and from the minds of the students. Maxwell's theory has not been taught or utilized in the Western

world in the 20th century! Only Heaviside's mutilated version of it is taught as "Maxwell's theory." We should have been applying Maxwell's unified theory and working on antigravity spaceships, shortly after the U.S. Civil War!

211. Vector field: in ordinary theory, the assigning of a magnitude and a direction (that is, a vector) to each point in space. The entire set of vectors and their spatial points is called a vector field. In the new approach, such a vector field cannot observably exist in a vacuum, since only disintegrated things exist there; there each potential vector pattern exists in broken virtual bits, ordered in line to form the bits of the observable vector but not joined. In the presence of a detecting/integrating mass, such as a spinning charged electron, the virtual bits and the spinning charged mass couple into a system that identically comprises the observable vector. In other words, the spin of an observable particle simply "integrates" the ordered virtual bit pattern, just as an old spinning wheel twists and integrates individual fibers into a stranded rope or thread.

212. Virtual (state): that part of physical reality consisting of changes (particles, waves, and other entities) smaller than the least detectable (quantum) change. Disintegrated changes. A thought or thoughtform is also virtual. May be visualized as consisting of real, dynamic "pieces of vacuum" or "pieces of nothing"—that is, quillons. Every ordinary observable particle (photon, neutron, electron, proton, etc.) contains or consists of a dynamically changing cloud of virtual objects. Exchange of virtual objects is thought to generate almost all forces of nature. Conservation of energy need not be conserved in virtual interactions, and generally is not. In the new approach, the mind may be considered a special virtual universe, and a thought a virtual object. Virtual state consists of multiply nested levels, each level progressively finer and more subtle. These sublevels also correspond mathematically to higher geometrical dimensions. Charge on a mass is also due to its continual emission and absorption of virtual particles. Waves in the virtual state massless charge flux, which do not breach the quantum level to become observable, are vectorially nonobservable yet real—these are scalar waves, or shadow vector waves, and are longitudinal—that is, they are oscillations of the stress energy tensor of vacuum. In addition, the virtual particles in the vacuum flux arise out of nothing spontaneously (creation) and disappear into nothing spontaneously (annihilation). Since this is random, at any instant any sort of pattern imaginable is "just appearing" and "just disappearing" in the vacuum. Anything and everything at all! Thus a ghost-pattern of everything exists in the vacuum at any point or region, at any time. The vacuum is thus a giant virtual-state hologram. Integrating (kindling) one of these forms will result in it becoming first a neutronic pattern, then a photonic (light) pattern, then a materializing pattern, and finally a material pattern. Discharge of the "potential" of this pattern then reverses the process. These two processes—charge-up and discharge—constitute materialization and dematerialization. Anything at all—living or dead—can be materialized or dematerialized.

213. Virtual state engineering: the direct cohering, tailoring, collecting, resonating, and directing virtual state energy (anenergy) and entities into and onto normal observable objects and ordinary fields. It includes the

direct engineering of mind and life energies. Synonymous with psychotronics (Czech term) or energetics (Soviet term). Use of scalar electromagnetics (electrogravitation). Use of scalar wave/Tesla technology. Use of electrogravitation techniques.

214. Water structuring: the arrangement and relations of the molecular and ionic parts of water. Essentially water molecules bond together by means of hydrogen bonds. The structure of these bondings is extremely rich and dynamic in water. Essentially a glass of water is a single complex molecule, one which is continually changing its bonding structure to adapt to the slightest change in its total surroundings. Water also interacts intimately with virtual crosstalk (scalar wave) anenergy. Water can thus be "charged" with anenergy, appreciably changing its structuring. Its surface tension, for example, will change as its structuring changes, as shown by Miller and Flanagan. Thus water is possibly the most complex substance in the universe, and not just a simple chemical. With most of our body composed of intercellular water, we are all linked to every subtle change of the cosmos, by the interaction of the structuring of this water with even the most subtle cosmological changes. Large bodies of water are particularly susceptible for temporary kindling of deeper archetypal thought forms (tul-poids) such as Loch Ness Monster etc. The study of the structuring of water is still in its infancy.

215. Watson, James: young inventor who has produced several types of free energy and scalar electromagnetic devices, including battery-driven, battery-less, and tube systems.

216. Weather engineering (scalar): use of scalar electromagnetics (electrogravitation) to change and influence the weather and the producers of weather such as jetstreams and large ocean currents. By imposing scalar signals upon ordinary powerful over the horizon (OTH) radar carriers in the communications band (3 to 30 MHz), interference patterns (grids) may be established over distant and vast areas, far beyond the horizon, or even on the other side of the earth. The giant Soviet Woodpecker OTH radars continually establish such a grid over the U.S. Phase conjugate energy can be transmitted and will travel along these beams, just as electricity travels along a wire. By scanning narrow phase conjugate wave beams in these wider carrier beams, PCR realtime interference holography can be established in one or more of the distant OTR EM carrier interference grid squares. Either positive or negative energy and energy forms may be transmitted to emerge, producing a high or low pressure spot or zone as desired. By adding positive energy to a zone, the air is heated and expands. Thus the air is less dense, producing a low pressure zone, or a low. By adding negative energy to a zone, an equal amount of positive energy in the zone is canceled. Thus the air in the zone contracts and is denser, producing a high pressure zone, or a high. Thus one can create distant highs and lows at will. By slowly moving (scanning) the PCR beams, these distant highs and lows can be moved, thus deviating and directing the jetstreams, storm systems, etc. By outputting positive energy and warming the top of a thunderstorm anvil, while outputting negative energy to the side of the anvil and cooling it, drastic "downbursts" under the anvil can be created. U.S. satellites have photographed such anomalous holes appearing in thunderhead anvils over the U.S., and their association



with downbursts has been documented in the literature. Whether these are natural or engineered have yet to be established. Another signature of weather engineering—a "wheel and spoke" type of cloud, called a giant radial—has been seen widely throughout the U.S. and correlated with anomalous weather changes shortly thereafter. Sometimes a system of two such radials facing each other is seen, and on one occasion four were seen locked together (just before and during the highly anomalous zig-zag travel of a 1985 hurricane in the Gulf.) Another geometrical form associated with severe weather has been photographed by U.S. weather satellites, and is referred to in the weather literature as an "enhanced V". This signature is closely associated with the production of tornadoes, and it may be a natural phenomenon. However, if the mechanism for the enhanced V were artificially produced in a thunderstorm, then the probability of follow-on tornadoes would be materially increased. The Soviets have openly engineered the weather over North America since 1976, and made previous R&D engineering tests over the U.S. in 1967.

217. Woodpecker signals: powerful, complex electromagnetic signals originating in the Soviet Union (apparently from the vicinity of Riga and Gomel, for example) that have widely disturbed and interfered with the communications band (3-30 MHz) since the mid-70's. Bioactive modulations of 10 Hz and under have been observed repeatedly. Western observers have not deciphered the purpose or specific coding of the signals, and prefer to think of them as some sort of over-the-horizon radar tests, thus neatly disposing of the problem. Similar signals have been observed to entrain the human brainwaves and force them into in-phase oscillation. Beck has reported the phaselocked synchronization of the 10 Hz modulations on as many as 16 carrier frequencies at once. From the Lisitsyn work, this constitutes a "phased lock-in" of 16 carrier channels into any entrained brain. According to Lisitsyn and earlier Soviet "biological radio" experiments, this situation should allow the Soviets to transmit emotion, feeling, thought, and even pictures into the entrained brain, where it is processed as if the brain itself had originated it. (For example, in a Cable News Network special in November 1985, Rauscher and Bise actually demonstrated the induction of visual form images in the brain of the CNN investigator using weak signals much weaker than those naturally produced by oscillation of the earth's magnetic field.) According to the Kazhnacheyev work, any sort of cellular death and disease pattern can be electromagnetically induced. (The work was duplicated in the infrared by University of Marburg researchers in West Germany, by researchers at the University of Sydney, and by one U.S. scientist.) Popp discovered the virtual photon communication system of the cells of the body. This is scalar, and scalar patterns for charge distributions of the chemistry of cellular diseases and damage could also be placed on the phase-locked Woodpecker carriers, entering the human body's master control system through the entrained brain and "kindling" throughout the cells of the body. The stress and suppression of the immune system would be involved in almost all disease patterns, and a "partial AIDS" type of syndrome would result, making the entrained body vulnerable to whatever diseases were around, including being induced on the Woodpecker carriers themselves. Also, by targeting the DNA of specific

organisms, mutations of deadlier and tougher strains of disease induction agents such as bacteria and viruses could be produced. The "antifithesis" pattern—a sort of scalar EM antidote—could be induced in the Soviet population. (The present lethal AIDS is a manmade disease, and it was unleashed from a research laboratory either accidentally or by a Soviet agent on purpose.) Indeed, World War III may already have begun, and the Soviets may be waging a quite different kind of creepingly escalating viral war against the United States. If so, our Defense Department and our government have not yet grasped what is happening, and so far we are simply a sitting, passive target. If our populace is slowly debilitated and storm, weather, and earthquake damage slowly increases year by year, at some point our system will simply start to come unglued, with increasing loss of control. In that manner we could "subside" as a world probability of the kind of great overt war we are familiar with. Note that steady escalation of international terrorism, insurrection, and guerrilla warfare being promoted by the Soviets around the world will keep us preoccupied and busy while our debilitation and morale steadily are increased. We may already be in an eery new kind of war that we could lose without firing a shot if our leaders do not wake up to the frightening implications of the new physics! Thus the Woodpecker transmitters represent a potential anti-population and strategic weapon of enormous strategic significance. The transmitters, because of their sheer power, also appear to be able to pump and resonate earth scalar EM energies, producing earthquakes and plasma discharge effects at remote locations. (Since Golden has directly shown that the entire earth is in fruitful, forced scalar resonance at multiple frequencies and enormous power due to powerful Soviet scalar transmissions, then one should not be too skeptical of the Soviet ability to produce earthquakes on demand and to order.) At least one U.S. researcher or group seems to have been partially nullifying Soviet efforts in this respect by occasionally pulsing the earth scalar energies in a countering mode, to include actual destruction of a Soviet transmitter in one or more instances. Note especially that unorthodox researchers have directly confirmed that the Woodpecker signals contain powerful scalar components which orthodox scientists—lacking scalar detection equipment—do not see. The Woodpecker carrier interference grid over the U.S. is also a scalar EM interference grid, and used by the Soviets to engineer the weather over North America. It is also used as an anti-Bomber and anti-missile launch phase defense system, and the Soviets have tested it in this mode by destroying several U.S. aircraft and missiles.

218. Work: conventionally, the line integral of force on a body over the path taken by the body. In the new approach, the force consists of the mass and its motional change, unseparated. Thus work is the line integral of the force over the path taken by the force. Work (past) is equal to the energy (present) expended, and energy (present, gravitational potential) is equal to the work (past, release of a gravitational potential) that can be expended. Note that only vectors produce work; scalar waves do not perform work on their observable environment, and they do not contain standard EM force field energy per se.

219. Yao, George: engineer and inventor of the PulsorR, which affects the subtle scalar levels of the human body's aura or scalar radiation pattern.

220. Veti: the Eastern—particularly Tibet, Nepal, etc.—Himalayan version of the apeman tulpid, corresponding to the U.S. Sasquatch or Bigfoot.

221. Zarg: the collective human unconscious, considered as a mind and a living entity. It is at least 4-billion dimensional, since it has as many dimensions as human stages. Each human is regarded as a single cellular stage in this entity. The psychokinetic power of such a linked mind is proportional to an exponential of the number of individual stages. Thus Zarg's psychokinetic power is so great that it has essential control over space and time, and largely prescribes, maintains, and stabilizes the laws of nature (laws of physics) and the reality in which we live. Conflict between large groups of humans constitutes unresolved conflict in this great unconsciousness, and this generates symbolic dreams, much as a human dreams strange, emotional, symbolic dreams due to the unresolved conflict in his or her personal unconscious mind. However, because of its vast psychokinetic power, Zarg materializes or partially materializes its symbolic dreams, resulting in tulpoids. Waves of these tulpid materializations thus represent strong human conflict or threats on the large scale. Such waves can be dream analyzed to discover the correlate that is generating the symbology, by straightforward dream analysis techniques. In olden times, part of this was known, and wise men were employed to analyze and interpret the strange, induced dreams of the king (who was the center of power of a nation) and the paranormal phenomena appearing near him. The ancients knew the import of "signs and wonders" and what they portended, but this metapsychological knowledge has been largely ridiculed and lost by present materialistic Western science.

222. Zero: naught or nothing; the absence of thing. A naive definition is the absence of number. However, if all the nonzero numbers are considered to represent the presence of number, then to declare zero a number—that is, the presence of a number—is a self-contradiction since it has just been declared the absence of number. In the numerical sense, one may do a little better by calling zero "the absence of any and all numbers except itself." Yet in this case, difficulties arise as to how one is to justify the addition of any other number to zero: how can a number be present with the absencing operator, so as to be added? The absence of any type of thing observable. Formally, the additive identity element of an algebraic system. That is, formally, the basic idea of zero is that, added to a number, the result is still identical to that number. Implicit in this formal definition is a "single level\*\* of perceived objects; that is, there are no "hidden objects" in a separate level of sets. If multiple levels of perception are allowed, then the zero becomes much more complex. That is, it represents the absence of all other numbers at that particular level, and of that level's kind. In that case, it may contain any combination of objects from another level, yet be perceived as containing "nothing of its own assigned level." In that case, there exists an infinity of different "kinds" of zeroes, if the hidden associated structure (the substructure) If taken into account Unfortunately physics has created such multiple levels, but has not required its mathematics to clearly specify the changed nature of the zero. As an example, at the observable level, an infinite number of kinds of zeroes exist, when the virtual level and pattern

associated with the zero are taken into account This characteristic of physics actually violates the following zero axiom: an observable  $v$  plus an observable zero is considered to be equal to an observable zero plus  $v$ . In fact, the sum of  $v$  and a particular zero may not be equal at all to the sum of another zero and  $v$ , if the virtual patterns of the two zeroes differ,  $v$  has a virtual substructure, and in the addition of a zero and  $v$ , their virtual levels nonlinearly interact instead of linearly superimpose.

223. Zero point energy: the kinetic energy that remains in a substance when its temperature is absolute zero. Quantum mechanics requires a simple harmonic oscillator to still possess kinetic energy at its lowest state: that is, it possesses half a quantum of energy. In solid materials it is distributed throughout the lattice vibrations, contributing to the binding energy. Vacuum also has zero point energy. Actually a similar and much expanded concept applies to any potential: a potential is just a bunch of trapped dynamic vectors, hence "trapped vector (translational) energy." It is translational energy that is locally trapped and not translating. The potential is thus like an accumulator or capacitor. It can be "charged up" and "discharged." It thus contains its own analog or trapped or "zero summed" or "zero point" energy.

224. Zero-point energy of vacuum: the vacuum is increasingly being regarded as composed of an incredibly dense structure of virtual electromagnetic energy, even at zero degrees absolute. From quantum geometrodynamics, as one approaches the Planck length—say, 10 to the minus 35th meters—these oscillations become so energetic that the fabric of spacetime itself is torn, resulting in sporadic, continual connection and disconnection of widely separated portions of spacetime. This "quantum foam" was dubbed "superspace" by J.A. Wheeler. Actually, if space and time are torn, then energy itself—and vector waves—are also torn. That is, the superspace consists of pure massless charge flux, pure scalar waves. If compacted, this anenergy density of vacuum may be approximated as 10 to the 100th grams per cubic centimeter, were it compacted into mass. The actual electrical charge of the vacuum appears to be enormous, if it were possible to measure a voltage drop from it to an uncharged region. Thus it is space (actually spacetime) that is incredibly dense, and matter that is ethereally thin. Spacetime goes through matter, rather than matter through spacetime. This anenergy of vacuum does interact with electromagnetic fields and matter to give observable effects, as evidenced by the Lamb shift, for example. The Lamb shift proves that the vacuum charge or anenergy can be "tapped." Tapping the "vacuum energy" would immediately end the energy crisis forever. Further, it can be done with practical devices, as T. Henry Moray showed in the 20's and 30's, and as several present inventors have shown today.

225. Zero vector: a vector having no length (no magnitude) or specific direction. Absence of any or all finite vectors. Resultant of a system of multiple, finite vectors whose vector sum has no specific direction. Note that the second definition differs drastically from the first. That if, we cannot say that a vector resultant zero has no in-folded magnitude, if we consider the components, all of whom have magnitude. See the discussion under "zero." In vector analysis, the zero vector axiom states that any vector  $v$  plus a zero vector is equal to a zero vector plus  $v$ . (Note that this axiom is not proven, just assumed).

However, there are an infinite number of different zero vector resultant systems, and so zero vectors may differ, if their infolded component "substructure" is considered. Indeed, a zero vector system must be identified as a special form of potential, if its substructure is considered. The common practice in electrical physics of replacing a zero-summed system of vectors with a vector zero is incomplete, and such did not exist in Maxwell's original quaternion theory. This present practice should be changed; the vector zero should be replaced with a special organized vector zero system and a scalar potential. By failing to do this, physics excludes the ability to engineer electrogravitation, spacetime, the virtual state, local general relativity, free energy, effects at a distance, and the probabilities of the states propagated by the Schroedinger equation. It also excludes scalar electromagnetics (electrogravitation), and unification of all forces in an engineering electromagnetics fashion. In the new view, a zero vector may be a system of vectors that vectorially sum or multiply to zero, but the components

may still exist "inside" and dynamically function inside the zero-resultant envelope. This substructure can act on nonlinear or resonant systems. Any or all components may be time varying, or none of them may be. The zero vector system may thus be a dynamic vacuum engine. In addition, such a vector zero system is considered to be also a scalar stress potential, whose magnitude is equal to the sum of the absolute values of the perpendicular components. In addition, a separate type of stress potential may be included for the magnitude of the absolute values of the swirl components (torques). Other associated potentials may be included for the system, particularly if the system is in multiple dimensions, if it consists of more than one type of virtual particle flux, if several fluxes intercommute, etc. Such a system can also be designed and created to deterministically interact with and on the life force itself, the mind, thought, and personality.

# BIBLIOGRAPHY

"Analysis of a Phenomenon Occurring at Bell Island, Newfoundland, **Canada on April 2, 1978**," P.A.C.E., Ottawa, Canada, 1978.

Thomas E. Bearden *Quiton/Perceptron Physics: A Theory of Existence, Perception, and Physical Phenomena*, Defense Documentation Center (DDC), March 1973.

Thomas E. Bearden, *Field, Formon, Superspace, and Inceptive Cyborg: A Paraphysical Theory of Noncausal Phenomena*, DDC, 1974.

Thomas E. Bearden, *A Conceptual Derivation of Einstein's Postulates of Special Relativity*, DDC, October 1975.

Thomas E. Bearden, *Restatement of the Heisenberg Uncertainty Principle For the Condition of Superposition*, DDC, October 1975.

Thomas E. Bearden, *A Postulated Mechanism That Leads to Materialization and Dematerialization of Matter and to Antigravity*, DDC, October 1975.

Thomas E. Bearden, *The Boundary Identity of Exact Opposites: A Simple Solution to the Age-Old Philosophical Problem of Change*, DDC, October 1975.

Thomas E. Bearden, *An Approach to Understanding Psychotronics*, privately published, 1976. Defense Documentation Center, AD-A027 866.

Thomas E. Bearden, "The One Human Problem, Its Solution, and Its Relation to UFO Phenomena," *Pursuit* (Journal of the Society for the Investigation of the Unexplained) January 1976.

Thomas E. Bearden, "Writing the Observer Back Into the Equation," address given to Princeton Center for Alternative Futures, Princeton, N.J., March 5, 1976.

Robert C. Beck, *Extreme Low Frequency Magnetic Fields and EEG Entrainment, A Psychotronic Warfare Capability?*, Bio-Medical Research Associates, Los Angeles, March 1978.

Robert C. Beck, *Instrumentation for Detecting, Recording, and Analyzing Natural and Man-Made ELF Signals and Human Brainwaves*, Bio-Medical Research Associates, Los Angeles, May 1978.

William Bise, "The Soviet 10 Hz Pulses—A Brainwave Programming Mechanism?" *Specula* (Journal of the American Association of Meta-Science), Huntsville, Alabama, Vol. 1, No. 3, 1978.

T. Townsend Brown, "Electrical Self-Potential in Rocks," *The Psychic Observer and Chimes*, Vol. 37, No. 1, January-March 1976.

Trevor James Constable, *The Cosmic Pulse of Life*, Merlin Press, Santa Ana, CA, 1976.

Trevor James Constable, "You, Too, Can Photograph UFO's from Airlines," *Psychic Observer and Chimes*, Vol. 37, No. 3, May-June 1977.

- George D. Curtis, "An Electromagnetic Radiation Pattern Over The Ocean," *Undersea Technology*, Vol. 5, No. 8, August 1964.
- Lars-Erik DeGeer, Swedish National Defense Research Institute, "Airborne Short-Lived Radionuclides of Unknown Origin in Sweden in 1976," *Science*, Vol. 198, No. 4320, December 1977.
- B.V. Deryagin and I.I. Abrikosava, *Soviet Physics, JETP*3, 819 (1957); 4, 2 (1957).
- P.A.M. Dirac, "Development of the Physicist's Conception of Nature," *Symposium on the Development of the Physicist's Conception of Nature*, ed. Jagdish Merha, D. Reidel Publishing Company, Boston, 1973, pp. 12-14.
- P.A.M. Dirac, "Quantized Singularities in the Electromagnetic Field," *Proceedings of the Royal Society of London, Series A*, Vol. 133, 1931, p. 6.
- William W. Edison, David L. Faust, Harry J. Kyler and John O. Pehek, "Kirlian Photography: Myth, Fact and Applications," presented at the session on *New Electronic Methods for Medical Diagnosis and Treatment Using the Human Energy Field: A New Beach-Head for Scientific Discovery*, Electro 78, May 23-25, 1978, IEEE, New York.
- Robert Eisberg and Robert Resnick, *Quantum Physics of Atoms, Molecules, Solids, Nuclei, and Particles*, John Wiley & Sons, 1974, pp. 63-68, 146-150.
- Hugh Everett, III, *The Many-Worlds Interpretation of Quantum Mechanics, A Fundamental Exposition*, with papers by J.A. Wheeler, B.S. DeWitt, L.N. Cooper and D. Van Vechten, and N. Graham; eds. Bryce S. Dewitt and Neill Graham, Princeton Series in Physics, Princeton University Press, 1973.
- Richard Feynman, *The Character of Physical Law*, M.I.T. Press, 1967, pp. 31-33.
- Richard P. Feynman, Robert B. Leighton, and Matthew Sands, *The Feynman Lectures On Physics*, Addison-Wesley, 1963, Vols. 1, 2, and 3.
- Marjorie E. Fish, "Journey Into the Hill Star Map," *Proceedings of the 1974 MUFON Symposium*, Mutual UFO Network, 1974.
- Richard Garvin, *The Crystal Skull*, Pocket Book, 1974.
- Burkhard Heim, *Unified Quantum Field Theory of Matter and Gravitation*, Mutual UFO Network, Seguin, Texas, 1972.
- Louise and Galen Hieronymus, *Tracking the Astronauts in Apollo 11, With Data From Apollo 8 Included*, Advanced Sciences Research and Development Corporation, Inc., Fort Lauderdale, Florida, 1969.
- J. Allen Hynek, *The UFO Experience: A Scientific Enquiry*, Ballentine, 1974.
- J. Allen Hynek and Jacques Vallee, *The Edge of Reality*, Regnery, Chicago, 1975.
- H.E. Ives, "Derivation of the Lorentz Transformations," *Phil. Mag.*, Vol. 36, June 1945.

- H.E. Ives, "The Behavior of an Interferometer in a Gravitational Field," *J. OPT. Soc. Am.*, Vol. 29, May 1939; and "The Behavior of an Interferometer in a Gravitational Field: II. Application to a Planetary Orbit," *Ibid.*, Vol. 38, April 1948.
- David Michael Jacobs, *The UFO Controversy in America*, Indiana University Press, 1975. [Foo-fighters]
- Brian D. Josephson, "Possible Connections Between Psychic Phenomena and Quantum Mechanics," *New Horizons*, Vol. 1, No. 5.
- V.P. Kaznacheyev et al, "Apparent Information Transfer Between Two Groups of Cells," *Psychoenergetic Systems*, Vol. 1, No. 1, December 1974.
- V.P. Kaznacheyev et al, "Distant Intercellular Interactions in a System of Two Tissue Cultures," *Psychoenergetic Systems*, Vol. 1, No. 3, March 1976.
- Louis Kervran, *Biological Transmutations*, Swan Publishing Company, Binghamton, N.Y., 1972.
- "Kindling, Once Epilepsy Model, May Relate to Kundalini," *Brain/Mind Bulletin*, Vol. 2, No. 7, February 21, 1977.
- N.A. Kozyrev, "Possibility of Experimental Study of the Properties of Time," *Pulkovo, O vozmozhnosti eksperimental' nogo issledovaniya svoystv vremeni*, September 1967, pp. 1-49, JPRS 45238, May 1968.
- Michael Ledeen, "A Mole in Our Midst?", *New York*, October 2, 1978, pp. 55-57.
- E.M. Lifschitz, *Soviet Physics JETP* 2, 73 (1956).
- James M. McCampbell, *Ufology: New Insights from Science and Common Sense*, Jaymac Company, Belmont, CA, 1973.
- George Meek, *Healers and the Healing Process*, Theosophical Publishing House, 1977.
- T. Henry Moray, *The Sea of Energy in Which the Earth Floats*, Cosray, Salt Lake City, Utah, 1960.
- Captain John D. LaMothe, Ph.D., *Controlled Offensive Behavior—U.S.S.R.*, ST-CS-01-169-72, Defense Intelligence Agency, Washington, D.C. (Released under the Freedom of Information Act.)
- Captain John D. LaMothe and Mr. Louis Maire, *Soviet and Czechoslovakian Parapsychology Research*, DST-1810S-387-75, Defense Intelligence Agency, Washington, D.C. (Released under the Freedom of Information Act.) [Pavlita]
- Charles Muses, "Applied Hypernumbers: Computational Concepts," *Applied Mathematics and Computation*, Vol. 3, 1976.
- Charles Muses's foreword to Jerome Rothstein, *Communication, Organization and Science*, The Falcon's Wing Press, Indian Hills, Colorado, 1958.
- Charles Muses and Arthur M. Young, eds, *Consciousness and Reality*, Out-erbridge & Lazard, 1972.

E.I. Parnov, *At the Crossroads of Infinity*, translated from the Russian by Vladimir Talmy, MIR Publishers, Moscow, 1971.

Harold Puthoff and Russell Targ, *Mindreach*, Delacorte, 1977.

Harold Puthoff and Russell Targ, "A Perceptual Channel for Information Transfer Over Kilometer Distances: Historical Perspective and Recent Research," *Proceedings of the IEEE*, Vol. 64, No. 3, March 1976.

*The Pyramid Guide*, ed. Bill Cox, El Cariso Publications, Lake Elsinore, CA. (Bimonthly: subscriptions are \$6.00 a year.)

Edward W. Russell, *Report on Radionics*, Neville Spearman, London, 1973.

R.M. Santilli, "Partons and Gravitation: Some Puzzling Questions," *Annals of Physics*, Vol. 83, No. 1, March, 1974, pp. 108-157.

Berthold E. Schwarz, "Stella Lansing's Movies: Four Entities and a Possible UFO," *Flying Saucer Review*, Special Issue No. 5, November 1973.

Berthold E. Schwarz, "UFO Contactee Stella Lansing: Possible Medical Implications of Her Motion Picture Experiments," *Journal of the American Society of Psychosomatic Dentistry and Medicine*, Vol. 23, No. 2, 1976.

Bob Shiarella, "The Mysterious 'Skull of Doom'," *Argosy*, Vol. 376, No. 4, April 1973.

Brad Steiger, *Mysteries of Time and Space*, Prentice-Hall, 1974.

Edwin F. Taylor and John Archibald Wheeler, *Spacetime Physics*, W.H. Freeman and Company, 1966.

Yakov P. Terletsii, *Paradoxes in the Theory of Relativity*, Plenum, 1968.

John White and Stanley Krippner, eds., *Future Science*, Anchor, 1977.

C. Louis Wiedemann, "Results of the N.J. 'Spook Light' Study," *Vestigia Newsletter*, Stanhope, N.J., May 1977.

Robert Anton Wilson, *Cosmic Trigger*, And/Or Press, Berkeley, CA, 1977.

V. Ye Savkin, *The Basic Principles of Operational Art and Tactics*, Moscow, 1972, U.S. Air Force translation, U.S. Government Printing Office, Washington, D.C.

Arthur M. Young, *The Reflexive Universe*, Delacorte Press, 1976.