



Manual on Building Bamboo Houses

This manual on how to build a bamboo house comes as a result of research conducted at the Engineering Structures Research Centre at City University by a team of development engineers funded by Pell Frischmann Consulting Engineers. The purpose of their research is to help communities where this kind of information is not accessible and yet the most valuable. The aim of the information provided here is to share knowledge on how to construct low-rise housing that is resistant to earthquakes, particularly in developing countries. The design plans produced by this team require only basic construction skills and tools. The materials are sustainable, durable, and can often be locally obtained. The development team is headed by Professor Kuldeep S. Viridi of City University, London, and Mr. Rossen D. Rashkoff. We appreciate their efforts and commitment to making safe and sustainable housing more accessible.

Building materials

1. Introduction

The construction materials for building a bamboo house should be readily available and accessible. Traditionally used construction materials are considered. The bamboo based house has a very low weight therefore foundations can be minimised. For wall construction are used wall panels, assembled from split bamboo grids and chicken steel mesh and plastered with cement mortar. Basic materials for house components (bamboo, wire, bolts, chicken mesh, and cement) are inexpensive. Bamboo can tolerate high values of deformations in the elastic range i.e. possesses high elasticity. Therefore bamboo houses when properly constructed are ductile i.e. being able to sway back and forth during an earthquake, without any damage to the bamboo poles.

Bamboo is available in commercial quantities using the established supply system. It is a renewable plant with a short rotation period. Bamboo grows to its full size for about a year. Another two or three years are required for the plant to gain its high strength. Bamboo can be grown even on degraded land. Construction materials from bamboo should be treated in order to achieve longevity. The use of high energy materials, like cement or steel, is minimized. Therefore the adoption of bamboo for house construction helps preserve the environment. On Figure 1 below, is shown a house having a load bearing structure built in bamboo.



[Figure 1- Bamboo house \(Image courtesy of IPIRTI - Bangalore, India\)](#)

2. Bamboo harvesting

Bamboo should be harvested during the dry season in the tropics. This reduces beetle attacks, since insects are less active during dry season. Bamboo should be harvested in autumn and winter in subtropical areas.

The branches should be carefully removed from the bamboo culms so that the outer skin is not damaged. After harvesting the canes can be stored vertically or horizontally. In the latter case the canes should be frequently supported in order to avoid bending out of shape. Canes should be protected from direct sun, soil moisture and rain. There are two ways for drying the bamboo canes. The bamboo poles can be dried for about 6-12 weeks, by allowing good air-circulation while being stored under a shed. Faster alternative is using kilns for drying the canes. In this way the bamboo canes can be dried for 2- 3 weeks. Workability of the canes is ideal when they are dry.

3. Bamboo preservation

The aim of bamboo poles preservation is to prevent the invasion of pests, insects and fungus. If left untreated, bamboo poles may not survive more than about two years. We recommend the following methods for treating bamboo poles:

- **Immersion**
Freshly cut bamboo poles are immersed in water for period of 4-12 weeks. During this time the nourishment for insects inside the poles is removed. Streams or ponds are suitable. Ponds should allow circulation of water. Immersion in saltwater is not a suitable technique.
- **Impregnating coatings**
Preservation with borate solution is an efficient technique. The method involves the borate/borax salt solution being pressure-fed in the pole until it is seen at the other end of the pole. The culms treated in this technique should be of mature age. The treatment procedure should be applied on the day of harvesting the bamboo. This is a severe requirement. Information on this method is available through INBAR bamboo research network in India.
- **Heating**
This method consists of heating the canes, for a short time in kilns to 150°C. Alternatively the canes can be placed into a large container and boiled (cooked) for 25 minutes. In Japan a method of boiling the bamboo in caustic ash solution has been used.

4. Checklist for obtaining construction quality bamboo poles

- Depending on the species, 3 to 5 year old bamboo is best for construction purposes
- The bamboo should be harvested in dry season in order to avoid fungus attack and excess pole moisture
- Use the appropriate species for the particular application
- Do not expose the bamboo poles to direct sun, moisture and rain
- Use only straight portions from the bamboo culms for construction poles
- Poles should be treated against insects and fungus

Planning and Layout

1. Introduction

This portion of the document deals with newly developed earthquake resistant type of bamboo house. The planning and layout of structural members are displayed at the various construction stages.

2. Proposed type of bamboo house

Indian Plywood Industries Research and Training Institute (IPIRTI) - Bangalore, India has constructed earthquake resistant prototype bamboo houses with the following main features:

- Use whole round bamboo columns and trussed rafters approximately every 1.2m as the main load bearing elements
- Use split bamboo grids and chicken steel mesh with cement mortar plaster to provide overall stability to the structure. These elements form infill panels that are about 5 cm thick.
- Application of preservative treatment of bamboo depending on the degree of hazard and service conditions. Apply BORON to treat bamboo grids and trusses and Creosote oil to treat columns
- Use of bamboo mat board (BMB) gussets in combination with mild steel bolts for load bearing joints in roofing structure
- Use of bamboo mat corrugated sheets (BMCS) as roof cladding and BMB for the walls, doors and window shutters

Assets of the above system can be listed as follows:

- Modular construction suits either prefabrication or assembling in-situ. Components can be prefabricated. For example roof trusses, bamboo grids for walls, window/door frames
- Light structure
- Lateral shear resistance is provided from bamboo poles restrained at plinth level and roof level as well as the infill walls

The planning of the proposed housing as well as the layout of structural members are presented below. Follow the sequence of images to view the construction process in progression.

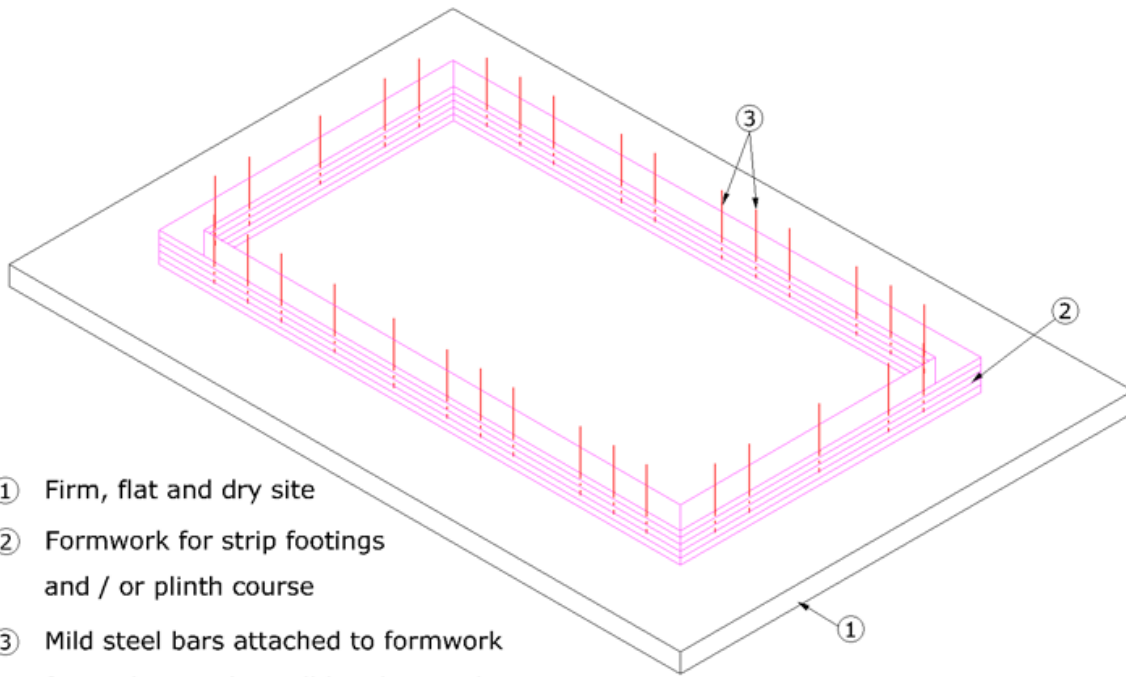

[Figure 2- Proposed bamboo house - phase 1](#)

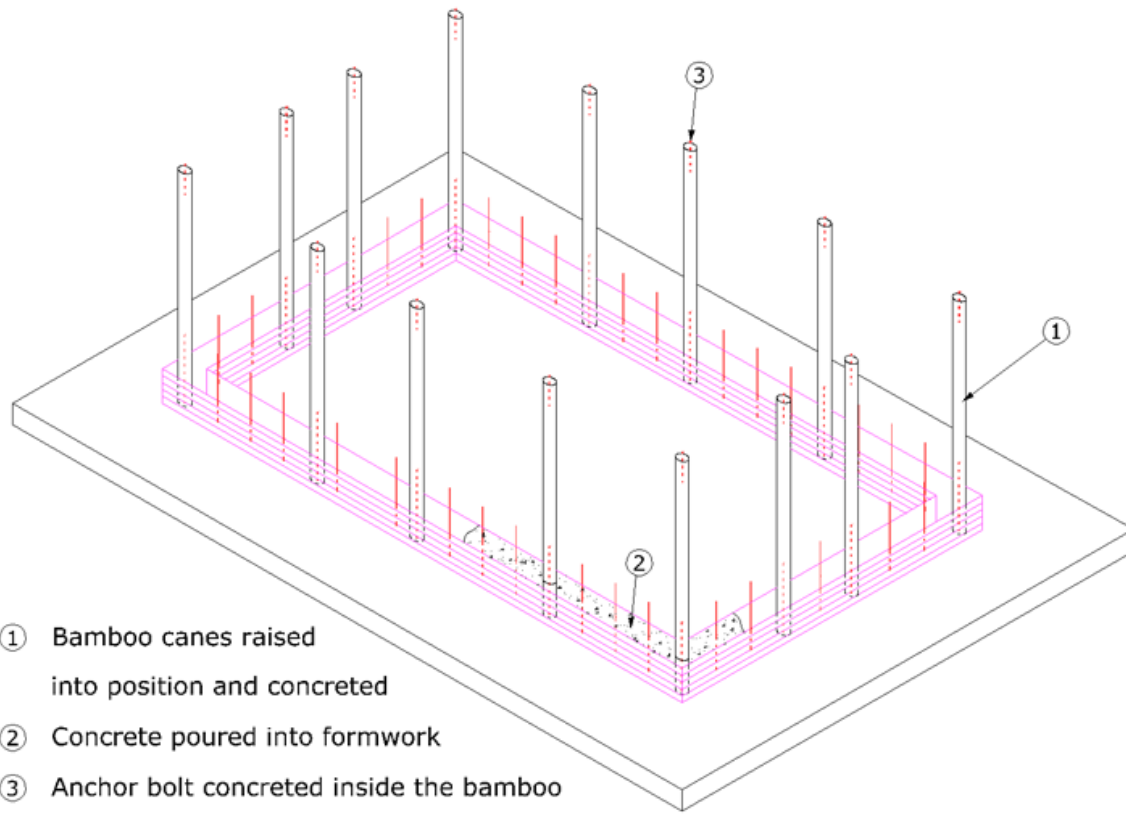

[Figure 3- Proposed bamboo house - phase 2](#)

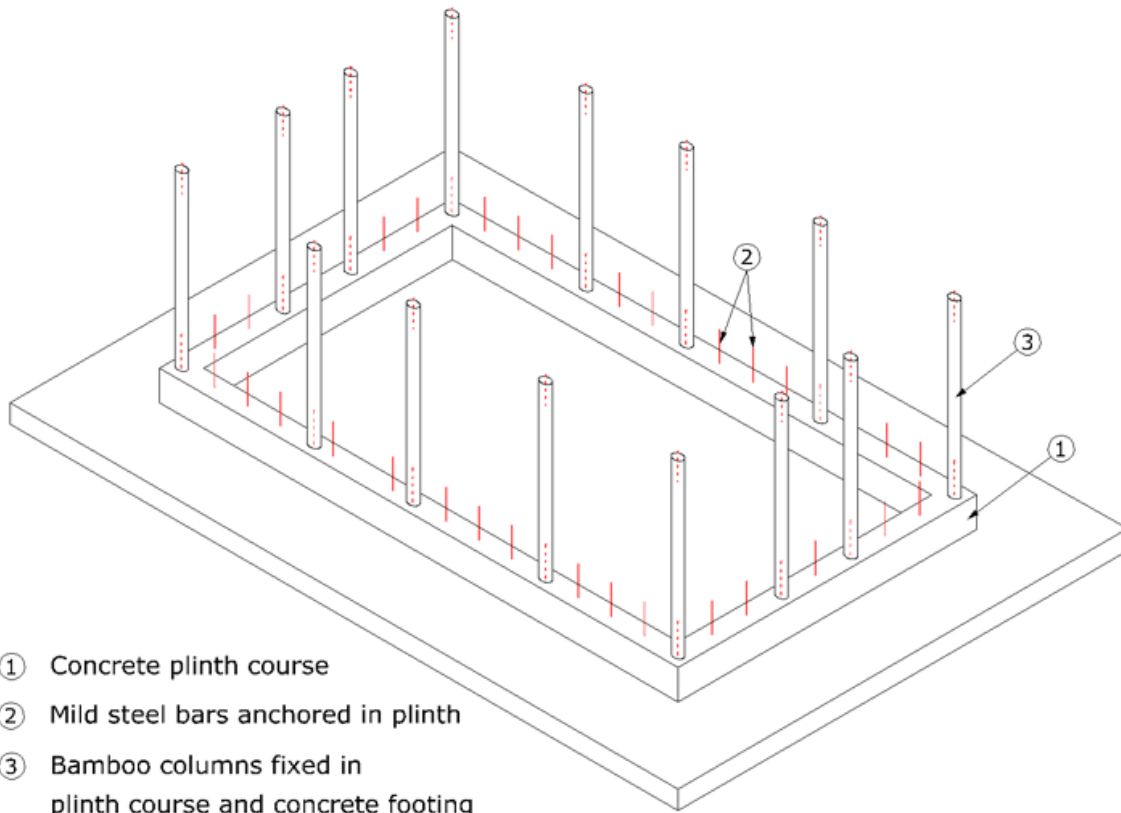

- ① Concrete plinth course
- ② Mild steel bars anchored in plinth
- ③ Bamboo columns fixed in plinth course and concrete footing

[Figure 4- Proposed bamboo house - phase 3](#)

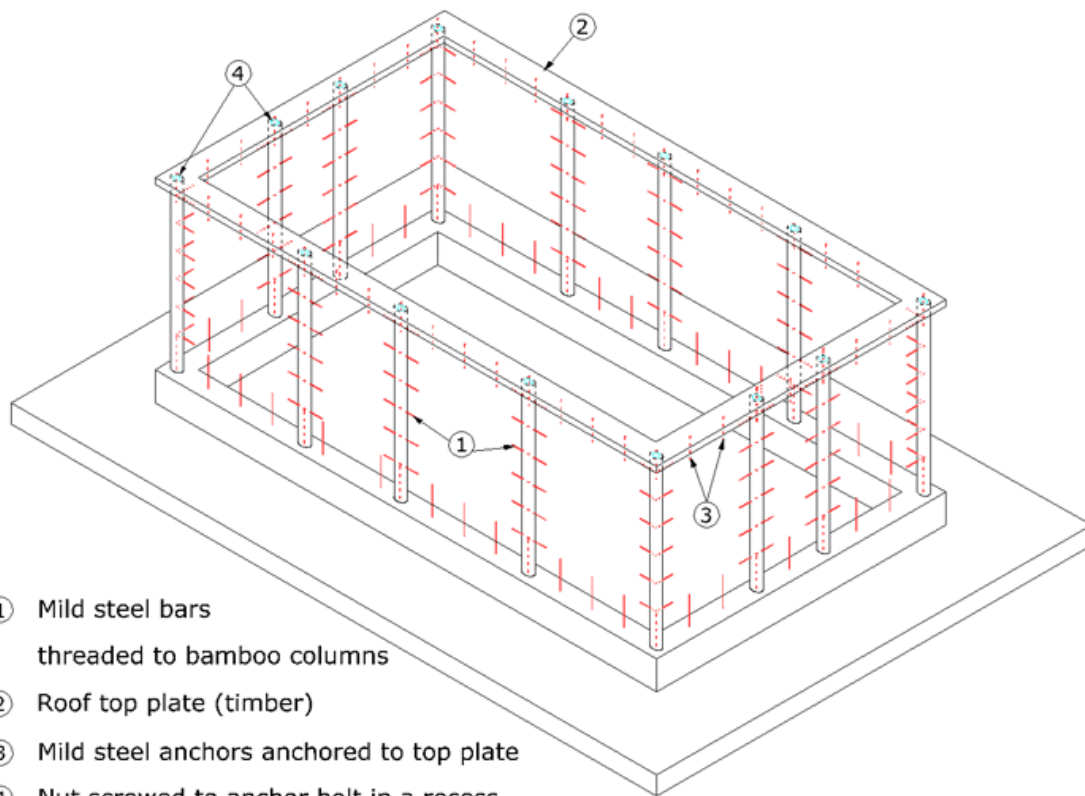

- ① Mild steel bars threaded to bamboo columns
- ② Roof top plate (timber)
- ③ Mild steel anchors anchored to top plate
- ④ Nut screwed to anchor bolt in a recess

[Figure 5- Proposed bamboo house - phase 4](#)

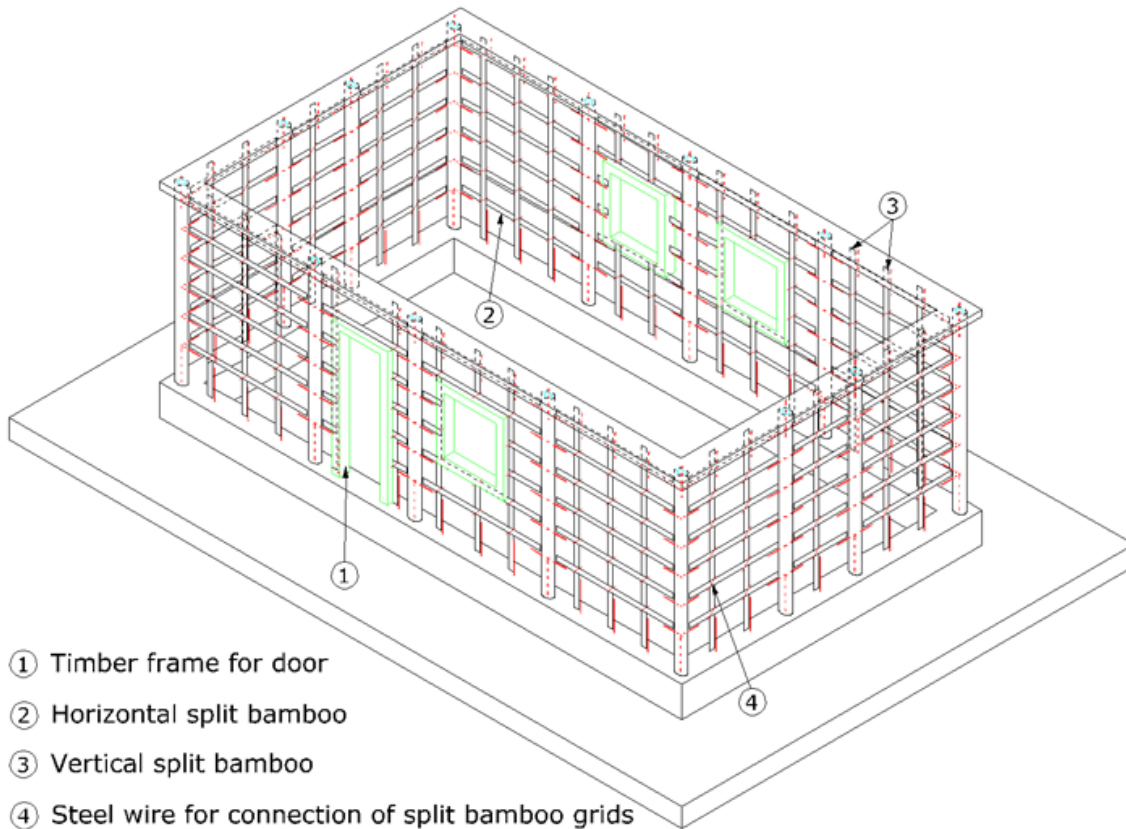

- ① Timber frame for door
- ② Horizontal split bamboo
- ③ Vertical split bamboo
- ④ Steel wire for connection of split bamboo grids

[Figure 6- Proposed bamboo house - phase 5](#)

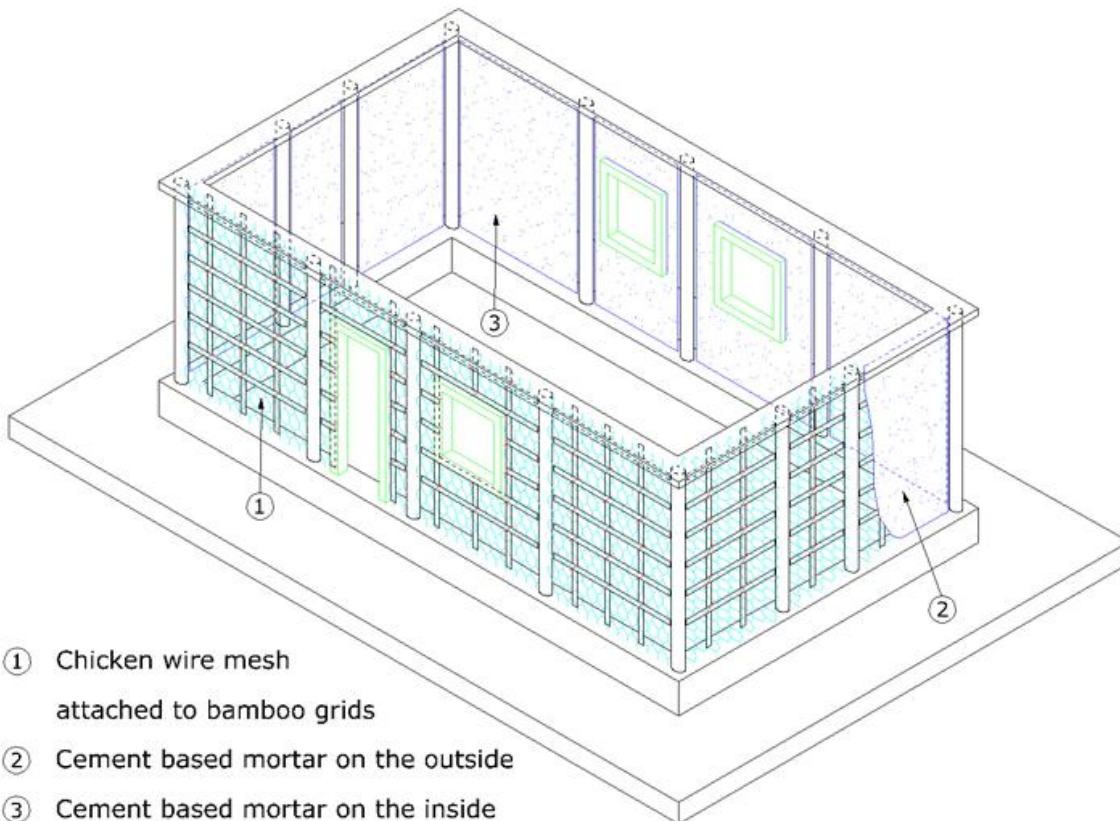

- ① Chicken wire mesh attached to bamboo grids
- ② Cement based mortar on the outside
- ③ Cement based mortar on the inside

[Figure 7- Proposed bamboo house - phase 6](#)

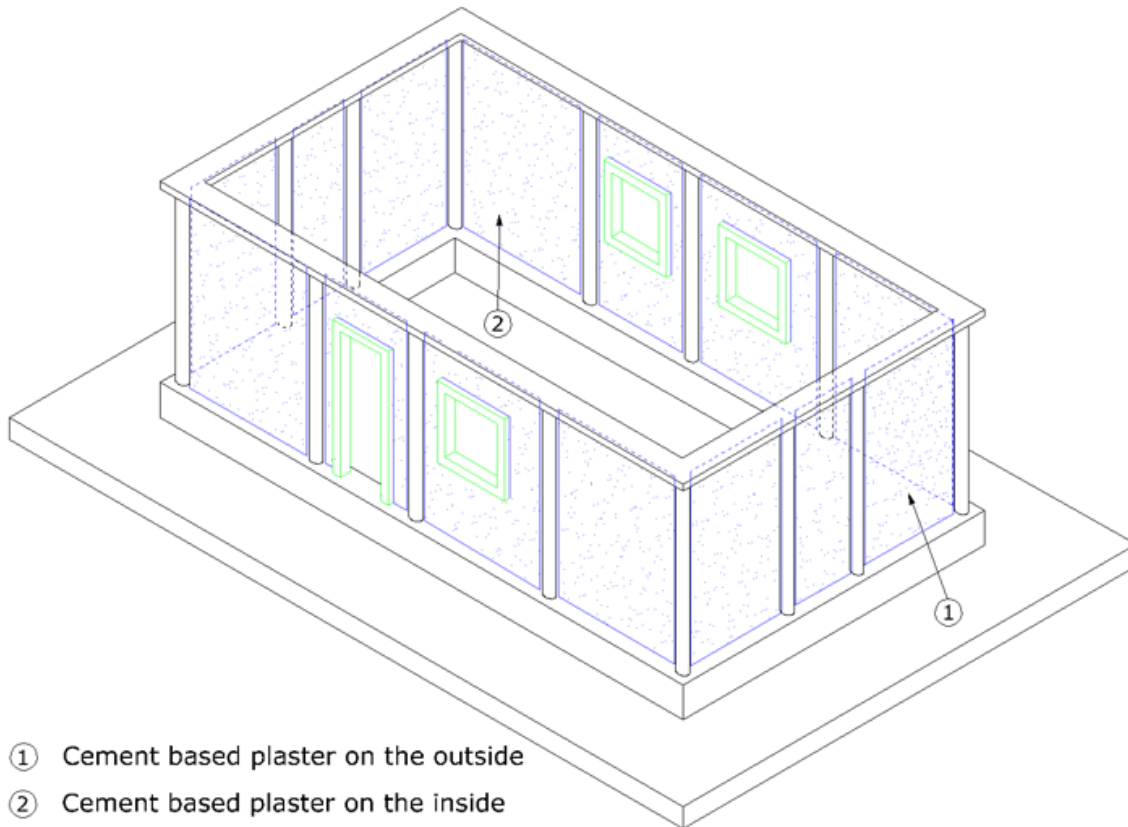

- ① Cement based plaster on the outside
- ② Cement based plaster on the inside

[Figure 8- Proposed bamboo house - phase 7](#)

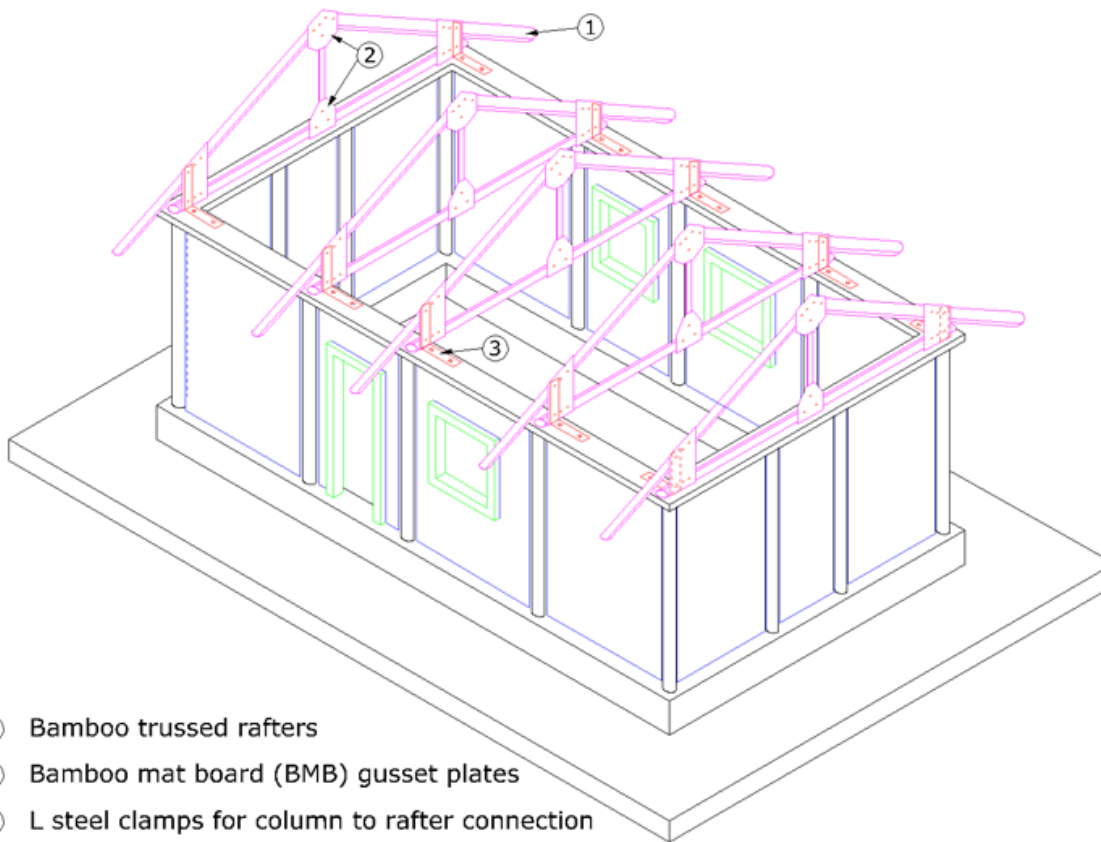

- ① Bamboo trussed rafters
- ② Bamboo mat board (BMB) gusset plates
- ③ L steel clamps for column to rafter connection

[Figure 9- Proposed bamboo house - phase 8](#)

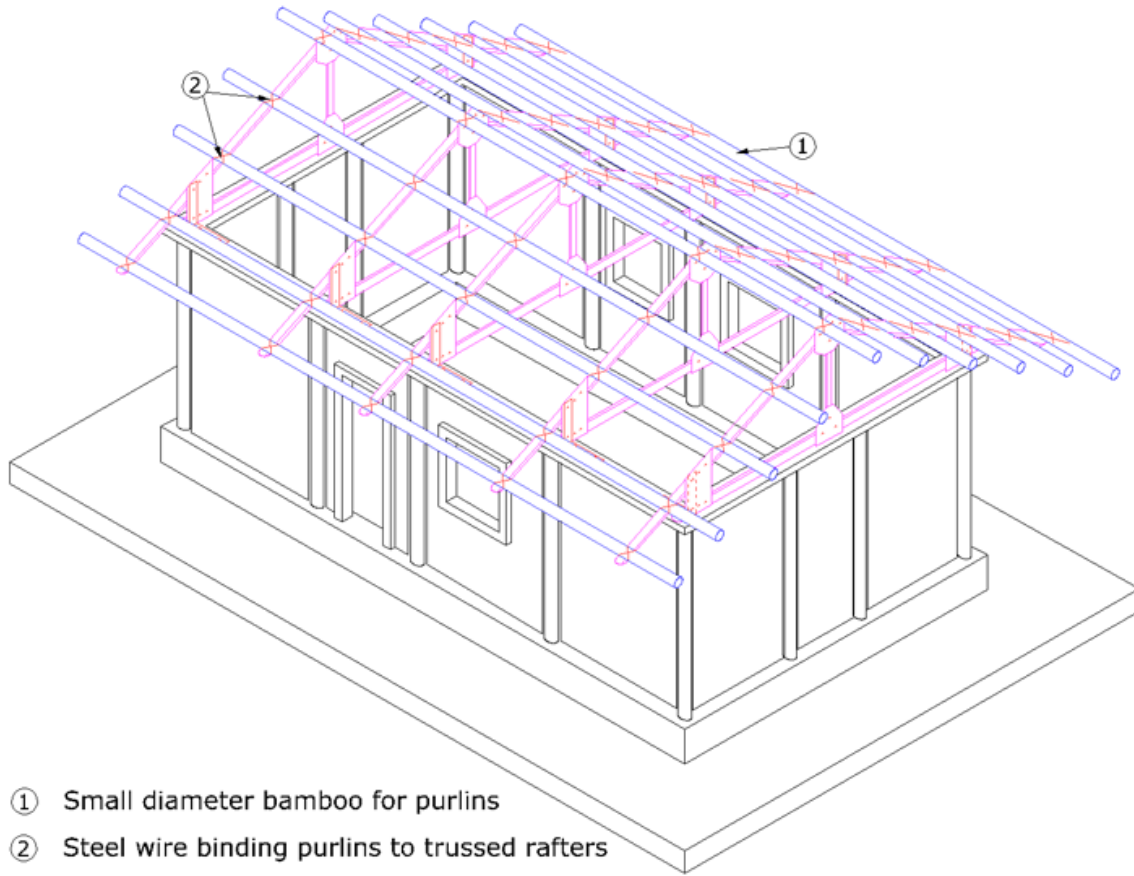

- ① Small diameter bamboo for purlins
- ② Steel wire binding purlins to trussed rafters

[Figure 10- Proposed bamboo house – phase 9](#)

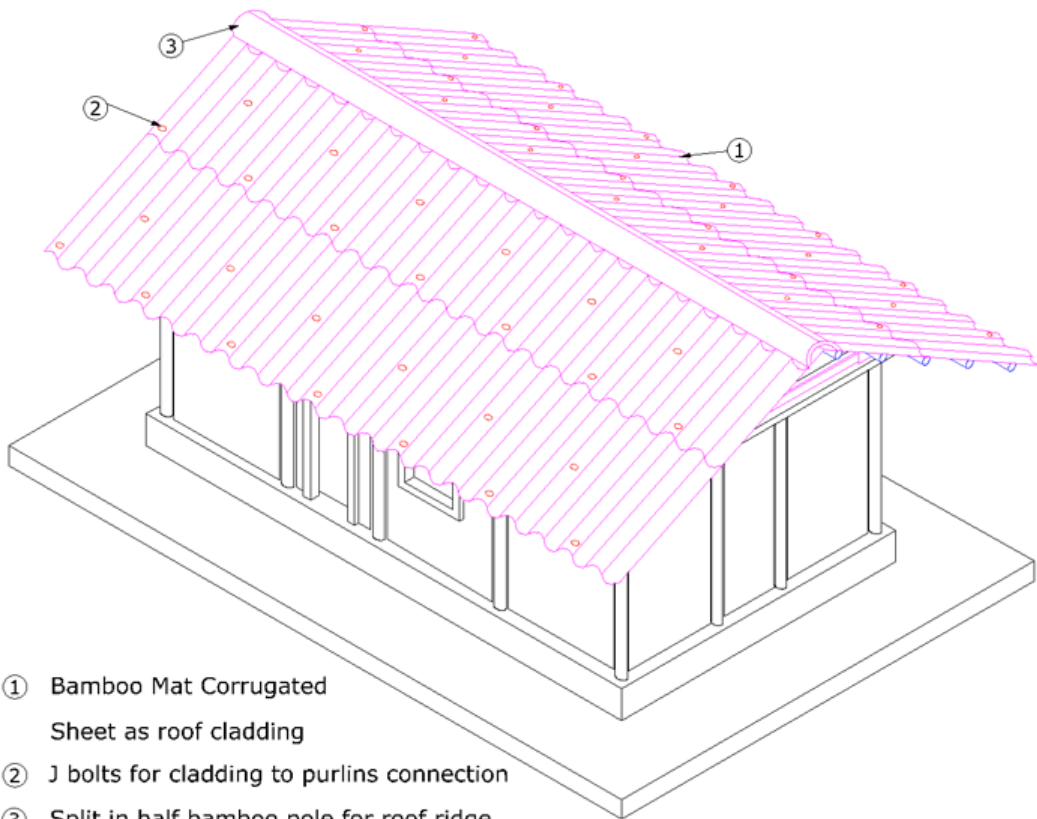

- ① Bamboo Mat Corrugated Sheet as roof cladding
- ② J bolts for cladding to purlins connection
- ③ Split in half bamboo pole for roof ridge

[Figure 11- Proposed bamboo house - phase 10](#)



[Figure 12- Prototype of a Bamboo house constructed according to the above technology \(Image courtesy of IPIRTI - Bangalore, India\)](#)

Construction Process

1. Introduction

Only basic carpentry, masonry tools and skills are necessary for the construction of bamboo house. The following methods are recommended for working of bamboo poles:

- Cutting with machete knife- see Figure 13
- Splitting the pole in half by using machete knife
- Splitting the bamboo culms into four or eight segments using a knife frame
- Peeling of the bamboo, when the age is less than 18 months. The strips can be used as ties or can be woven together to make strings or ropes
- Bending - freshly cut bamboo can be bent. If heated at 150°C the bamboo keeps its shape after it goes cold

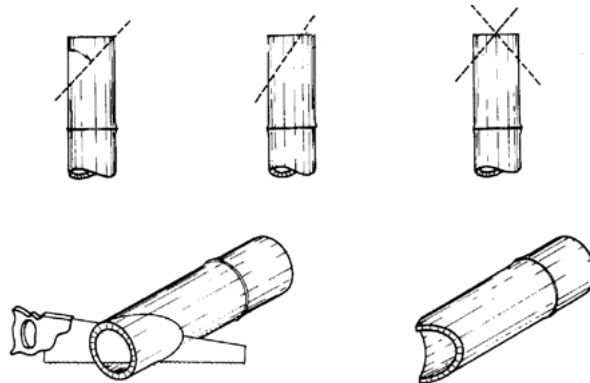

[Figure 13- Tools for cutting bamboo \(Image courtesy of O. Lopez, Universidad nacional de Columbia\)](#)

On Figure 14 are shown end profiles of bamboo poles for use in construction.

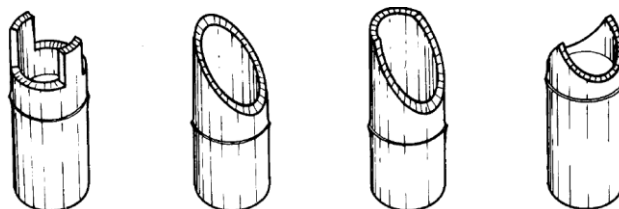

[Figure 14- Bamboo poles end details \(Image courtesy of O. Lopez, Universidad nacional de Columbia\)](#)

The necessary information for the process of proposed bamboo house construction is outlined below. Follow the sequence of images as presented above if you want to view the construction process in progression.

2. Foundations and plinth course

Bamboo canes should not be exposed to moisture. This is the main reason for which using bamboo in foundations is not a good practice. Bamboo canes should not touch the soil since their durability is greatly affected.

Concrete foundations are recommended for greater stability. Concrete wall bases prevent humidity affecting the bamboo canes in the walls.

A trench of min depth 0.5 m and min width of 0.3 m is excavated. The trench can be filled with field stones and cement grout in layers to form strip foundations underneath walls. It is recommended that the plinth course be completed also in concrete. The height of plinth should be above the flood water line or a minimum of 350 mm above ground level. Therefore formwork should be erected for the plinth course to be constructed together with the foundations. The bamboo columns should be erected in place and be embedded in the plinth course min 250 mm. The canes should be attached to the formwork to ensure vertical position during concrete casting. The following specifications can be used:

- Field stone - max size 200 mm
- Grout - cement based mixed in proportion 1 : 4 (cement : sand) by volume
- Bamboo columns - canes with diameter of 100mm
- Concrete for plinth - mix by volume, cement : sand : aggregate : water = 1 : 3 : 3 : 1.3

3. Construction of walls

The walls are constructed between the vertical bamboo columns, as infills. The main posts are erected at all corners, and throughout the house envelope, spaced at about 1.2 m. Split bamboo grids are assembled by rope or wire ties and are fixed to plinth and bamboo posts. To reinforce the bamboo grids, as well as to provide a base for the mortar, a chicken steel wire mesh is fixed to the grids. Cement based mortar is then plastered on top to provide overall stability to the wall infills. The finished wall thickness is about 50 mm thick. Prefabricated timber frames are mounted for windows and door openings.

4. Construction of top timber plate acting like a bond beam

All bamboo columns should be fixed to a top ring continuous beam. This member should be made from timber and should have rectangular cross section. Bamboo poles should not be used for top ring beams. This beam acts like a bond beam, providing restraint and stiffness to the bamboo columns and walls. Care should be taken to ensure continuity at wall corners.

5. Construction of roof

The roof should be ideally as light as possible. This would not only reduce lateral seismic loads, but would also reduce the risk of casualties in the event of roof collapse or partial collapse. Simple couple roof is adopted with bamboo trusses for rafters. The rafters are fixed to the timber top beam by means of steel clamps. Bamboo mat board (BMB) gussets, in combination with mild steel bolts, are used for the truss rafter joints. For purlins are used smaller diameter canes. Bamboo mat corrugated sheets (BMCS) are used for roof cladding. This type of roof doesn't transfer thrust onto supporting walls from gravity loading. The roof overhang of 400 mm is recommended.

6. Cladding and finish

Bamboo mat corrugated sheets (BMCS) are used for roof cladding. The sheets are anchored to purlins by means of J bolts. BMB is used for doors and window shutters.

Details for seismic resistance To beginning of document

1. Introduction

The information in this portion of the document will be divided in two parts. The first part will show details for seismic resistance of the proposed bamboo house. The second part will discuss more general information on detailing bamboo joints.

2. Details for seismic resistance of the proposed house type

In the proposed bamboo house the columns are constructed from whole bamboo poles. The poles are fixed at the level of foundations/plinth. For this purpose the end 500 mm of the pole is injected with cement based mortar and reinforced with a steel bar- see Figure 15. The canes should be reinforced in this way before mounting them in the foundations.

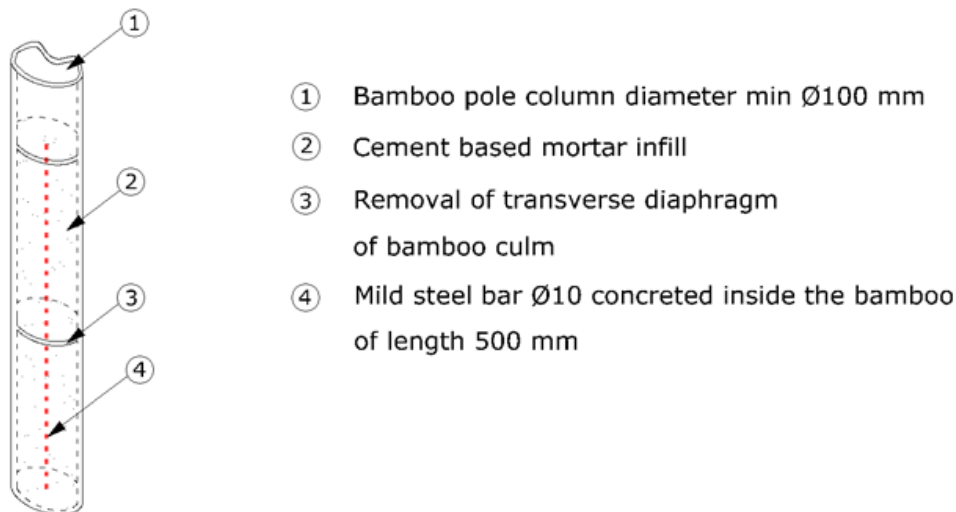

[Figure 15- Reinforcing the bamboo columns at foundation/plinth level by embedding a steel reinforcing bar in mortar](#)

All bamboo columns are connected at the top to a timber ring beam. This beam has a rectangular cross section. The bamboo pole column is connected to this beam through an anchor bolt. The anchor bolt is embedded in the pole where cement based mortar is injected- see Figure 16.

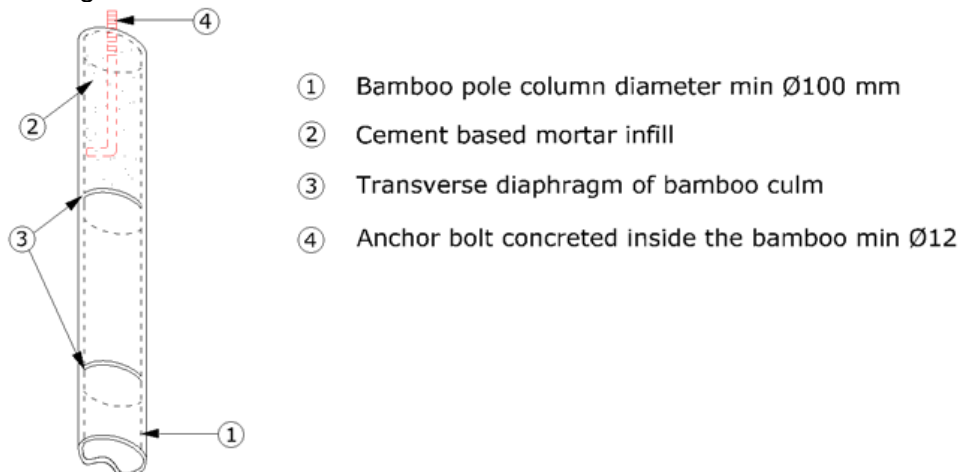

[Figure 16- Embedding an anchor bolt at the top of bamboo columns](#)

The walls are constructed between the vertical bamboo columns, as infills- see Figure 17. Split bamboo grids are assembled by rope or wire ties and are fixed to plinth and bamboo posts. For this purpose reinforcing bars are anchored in the bamboo columns and plinth- see Figure 18. To reinforce the bamboo grids, as well as to provide a base for the mortar, a chicken steel wire mesh is fixed to the grids. Cement based mortar is then plastered on top to provide overall stability to the wall infills.



< [Figure 17- Grids of split bamboo constructed between bamboo poles \(Image courtesy of IPIRTI - Bangalore, India\)](#)



>[Figure 18- Detail of bamboo grids connection to columns \(Image courtesy of IPIRTI - Bangalore, India\)](#)

The connection detail between the top ring beam and bamboo columns is shown on Figure 19.

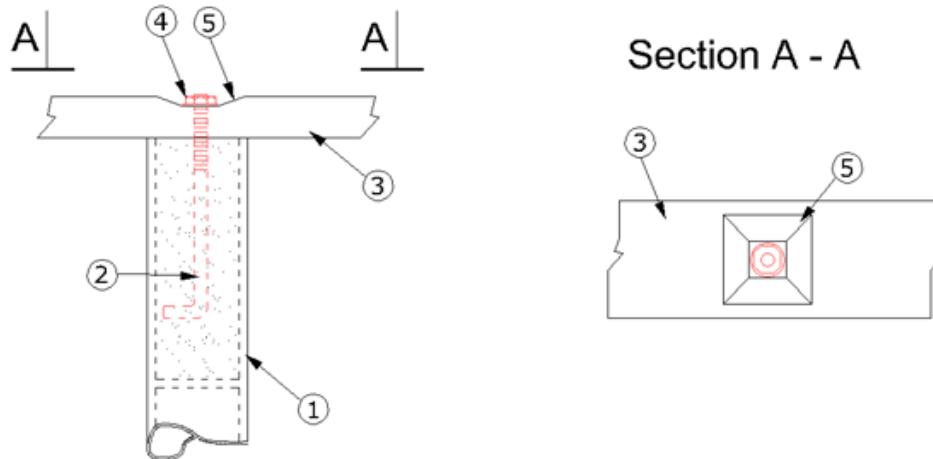

- ① Bamboo pole column diameter min \varnothing 100 mm
- ② Anchor bolt concreted inside the bamboo min \varnothing 12
- ③ Top ring timber beam 140 x 70 mm
- ④ Washer and nut
- ⑤ Recess in the top ring beam

[Figure 19- Connection between bamboo columns and top timber ring beam](#)

The main roof support structure consists of bamboo trusses. The load from the bamboo truss is transmitted to the bamboo columns through the top ring beam. The roof trusses are connected to the top ring beam by steel clamps- see Figure 20.

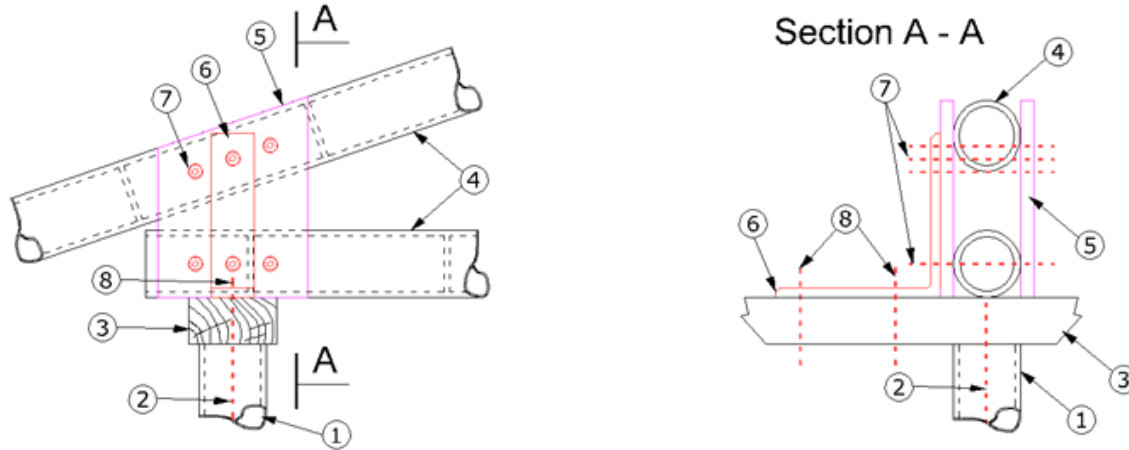

- ① Bamboo pole column diameter min $\text{Ø}100$ mm
- ② Anchor bolt concreted inside the bamboo pole column min $\text{Ø}12$
- ③ Top ring timber beam 140 x 70 mm
- ④ Truss rafter made from bamboo poles diameter $\text{Ø}100$ mm
- ⑤ Bamboo Mat Board (BMB) gusset plates thickness 14 mm with openings
- ⑥ L- Clamps of size 150x150 mm of width 40 mm and thickness of 6 mm
- ⑦ Mild steel through bolts $\text{Ø}8$ mm of length min 160mm
- ⑧ Mild steel bolts $\text{Ø}8$ mm of length min 160mm for fixing to ring beam

[Figure 20- Connection between roof truss and top timber ring beam](#)

Bamboo mat corrugated sheets (BMCS) are used for roof cladding. The sheets are anchored to purlins by means of J bolts- see Figure 21.

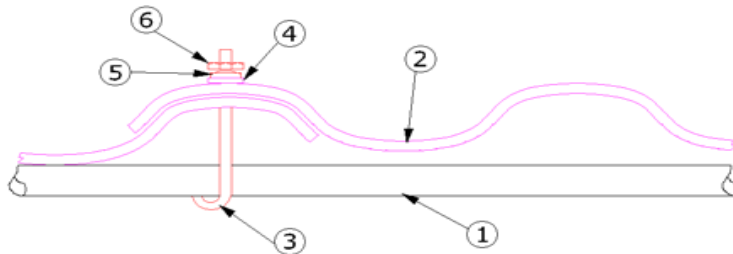

- ① Bamboo purlin diameter $\text{Ø}40$ mm - $\text{Ø}50$ mm
- ② Bamboo mat corrugated sheet (BMCS)
- ③ J-bolts $\text{Ø}10$ of length 100 - 125 mm
- ④ Bitumen washer
- ⑤ Cupwasher
- ⑥ Nut

[Figure 21- Connection between roof BMCS and roof purlins](#)

3. Joint details in bamboo houses

There have been known a number of complications when connecting bamboo canes:

- Connections of round profiles lead to complicated geometry at the knot
- Bamboo fibres only grow in the longitudinal direction
- Bamboo is hollow. There is no material to tighten the bamboo in the middle of the cane
- The face of the cane is hard and slippery
- Bamboo is not suitable for loads in cross direction

Two types of connections will be discussed. The friction tight rope(strapping) connection and the bolting connection.

In the friction tight rope connection the bamboo poles at joints are held in place by straps. Usual materials are rind strips of bamboo, rattan or lianas. Soaked before use they are more pliable. When drying, the fibers shrink and the connection of the bamboo poles tightens. The ties are also of organic material and therefore provide optimal compatibility between the elements of the construction system. Cords and ropes are made of bamboo bark, bast, and coconut. Nowadays also plastic cords are used. Bamboo ropes of twisted bamboo fibers can be produced in lengths up to 350 m. The strips for lashed connections should be two or three fold nylon or vegetable fibers of the same length. Steel wire has also been used for tied joints. One problem with lashed connections is that if the canes were green and not properly cured, there could be a volume change of the bamboo and slacking at the joint.

Alternative to the lashed connections are bolted connections solidified with mortar. For this type of connection a holes in the bamboo are drilled with an electric hand-driller. The poles at the connection zone are filled with mortar. This is required since the steel bolts could crush the walls of the bamboo poles. This type of connection is preferred when considerable compressive forces are being transferred across the joint.

When injecting mortar and solidifying of the joint zones are not possible other techniques can be used.

Alternatively at a bamboo joint the load should be transmitted at a location where there is a horizontal diaphragm in the bamboo pole. If this is not observed the hollow bamboo cane can crush under compressive load- see Figure 22.

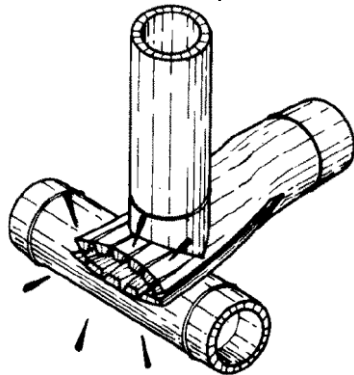

Figure 22- Compressive force transfer through a joint away from pole diaphragm (Image courtesy of O. Lopez, Universidad nacional de Columbia)

Transferring compressive force through a joint at a location of bamboo pole transverse diaphragm may avoid crushing of the member- see Figure 23.

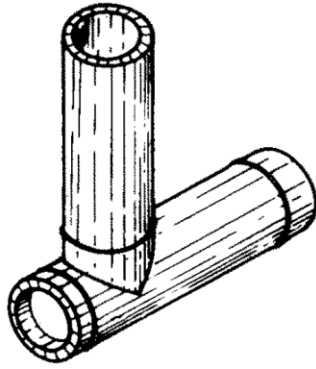

Figure 23- Compressive force transfer through a joint at a location of pole diaphragm (Image courtesy of O. Lopez, Universidad nacional de Columbia)

Another way to strengthen the bamboo pole for compressive loads acting in radial direction is by inserting a short, smaller diameter cane into the bamboo member- see Figure 24 and Figure 25.

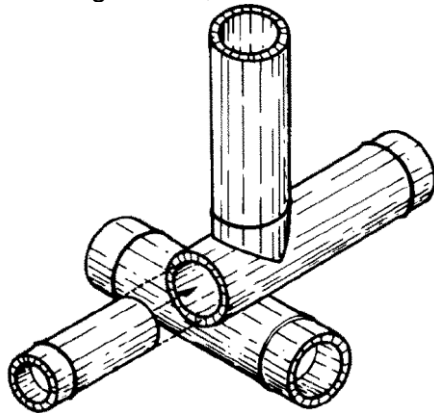

Figure 24- Inserting short, smaller diameter bamboo pole to strengthen bamboo member at a joint (Image courtesy of O. Lopez, Universidad nacional de Columbia)

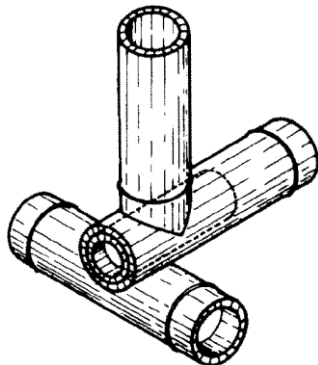

Figure 25- Inserting short, smaller diameter bamboo pole to strengthen bamboo member at a joint (Image courtesy of O. Lopez, Universidad nacional de Columbia)

References

- 1) Oscar Hidalgo Lopez, Manual de construccion con bambu, CIBAM, Universidad nacional de Columbia
- 2) DeBoer, D., Bareis, K., Bamboo building and culture- the architecture of Simon Velez, architect, Bogota, Colombia
- 3) Building Materials and Technology Promotion Council (BMTPC), Bamboo- a material for cost effective and disaster resistant housing, Ministry of Urban Development & Poverty Alleviation, New Delhi, India

- 4) Bamboo as a building material, University of Aachen, Germany
- 5) Bamboo Connections, University of Aachen, Germany
- 6) Indian Plywood Industries Research and Training Institute (IPIRTI) - Bangalore, India
- 7) Murty, C., Rai, D., North Andaman (Diglipur) earthquake of 14 September 2002, Indian Institute of Technology Kanpur (IIT Kanpur), 2003, India
- 8) Junior, R., Mascaro, J., Bamboo Architecture, Universidade para o desenvolvimento do estado e da regio do pantanal and Universidade federal do rio grande do sul, 2000
- 9) Environmental bamboo foundation, Bamboo preservation, Environmental bamboo foundation, Bali, Indonesia, 2003
- 10) Institut für leichte flächentragwerke (IL), IL 31 Bamboo, University of Stuttgart, 1985
- 11) Beraldo, A., Azzini, A., House prototype from different types of bamboo, Faculdade de Engenharia Agrícola, Costa Rica, 2000
- 12) Asociacion Colombiana de Ingenieria Sismica, Manual de construccion sismo resistente de viviendas en bahareque encementado, La Red de estudios sociales en prevencion de desastres en America Latina, 2001
- 13) Affordable bamboo housing in earthquake prone areas, An international workshop organised by Cane and Bamboo Technology Centre, Government of Mizoram, International network for bamboo and rattan, Aizawl, Mizoram, India, 2001
- 14) Johnny Astrand, Construction in the developing countries- a guide for the planning and implementation of building projects, The Swedish Mission Council, Stockholm, 1996
- 15) PowerPoint Presentation for July 27, 2003 Rangamati, Bangladesh Earthquake, by Dr. Mehedi Ahmed Ansary Department of Civil Engineering Bangladesh University of Engineering and Technology
- 16) Bamboo Housing Training at Indian Plywood Industries Research and Training Institute (IPIRTI), 2004, Bangalore, India
- 17) Christoph Tönges, Science and technology for construction with bamboo 'Guadua angustifolia', Germany
- 18) Gladys Garcia, Withstanding an Earthquake, Pontificia Universidad Católica, Peru, IDRC Reports, 1992
- 19) International Network for Bamboo and Rattan (INBAR), INBAR Housing Activities
- 20) Indian Plywood Industries Research & Training Institute, IPIRTI

City University. "Bamboo Houses." Accessed 19 August 2010.

<http://www.staff.city.ac.uk/earthquakes/Bamboo/Bamboo.htm>

Note: This website also contains manuals for building earthquake resistant housing out of adobe, stone, timber, brick, and concrete blocks.