

AT MICROFICHE REFERENCE LIBRARY

A project of Volunteers in Asia

Teknologi Kampung: hCollection of Indiaenous
Indonesian Technologies

by: Craig Thorburn

Published by:

Volunteers in Asia
Appropriate Technology Project
P.O. Box 4543
Stanford, CA 94305 USA

Paper copies are \$ 6.00.

Available from:

Volunteers in Asia
Appropriate Technology Project
P.3. Box 4543
Stanford, CA 94305 USA

Reproduced by permission of Volunteers in Asia.

Reproduction of this microfiche document in any form is subject to the same restrictions as those of the original document.

\$5.00

Traditional technologies are an often overlooked resource of human ingenuity. Building on such technologies is a promising approach to appropriate technology development. Using detailed drawings and descriptions. **Teknologi Kampungan** surveys tools and techniques invented and adapted within Indonesian communities.

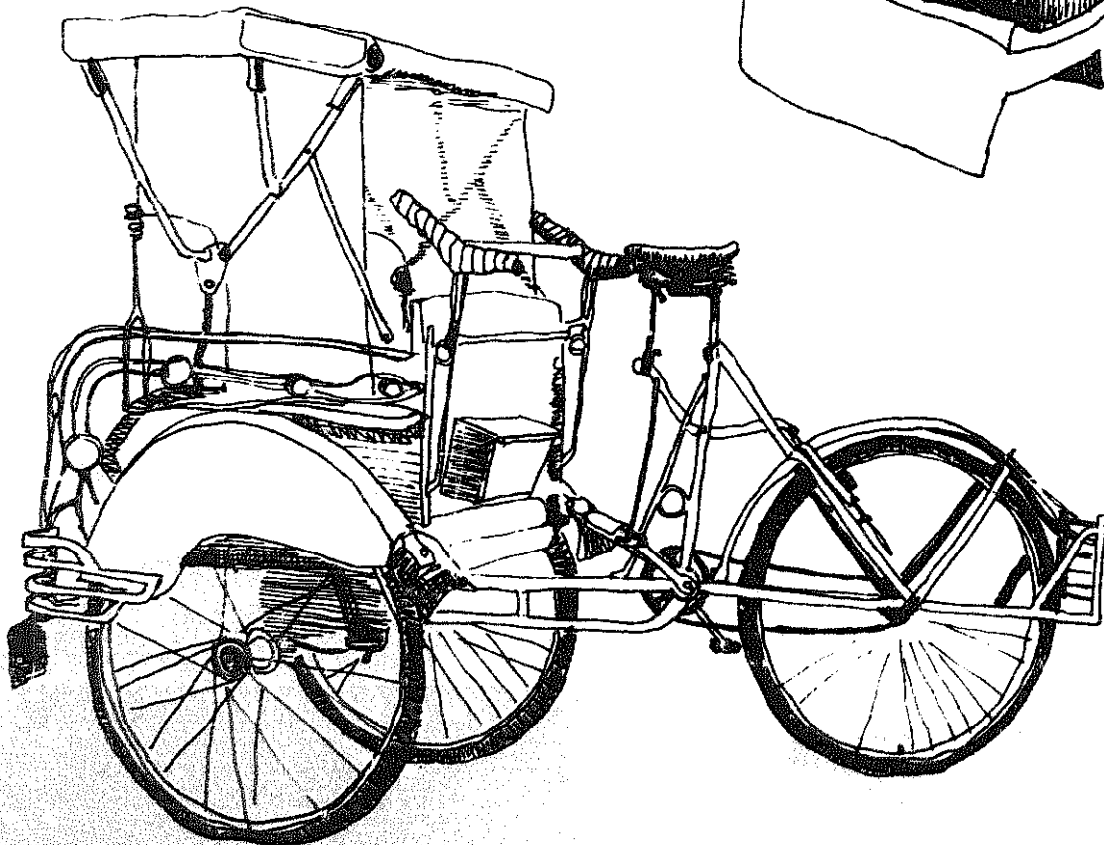
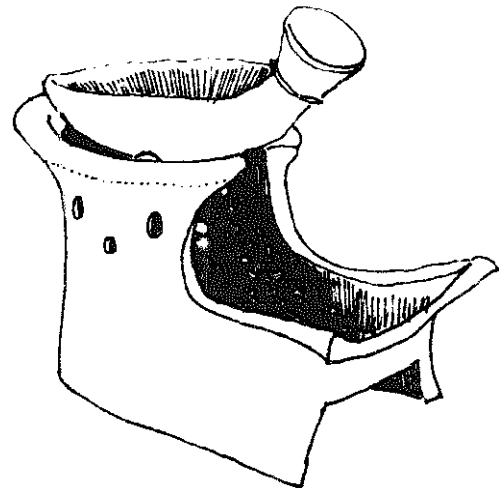
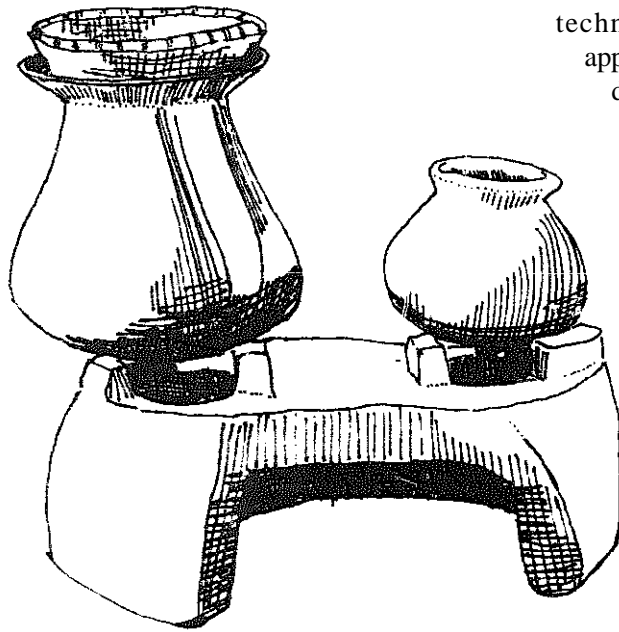

teknologi Kampung

a collection of
indigenous Indonesian technologies

By Craig Thorburn

The Institute for Social
and Economic Research,
Education and Information

Edited by Ken Darrow and Bill Stanley

June 1982

A Publication of
The Appropriate Technology Project of Volunteers in Asia

Craig Thornburn is the author and illustrator. His work on this book was supported by a grant from the Asia Foundation to the Institute for Social and Economic Research, Education and Information (LP3ES), an Indonesian non-profit organization. LP3ES is publishing an Indonesian language edition.

The English language text presented here was edited by Ken Darrow and Bill Stanley. This edition was published by the Appropriate Technology Project of Volunteers in Asia, with support from United Methodist Committee on Relief, Church World Service, and Catholic Relief Services.

Copyright © 1982
by Volunteers in Asia, Inc.
All rights reserved.

First Printing June 1982
Printed in U.S.A.

ISBN 0-917704-16-9

Additional copies of this book are available for \$5.00 from Appropriate Technology Project, Volunteers in Asia, P.O. Box 4543, Stanford, California 94305, USA.

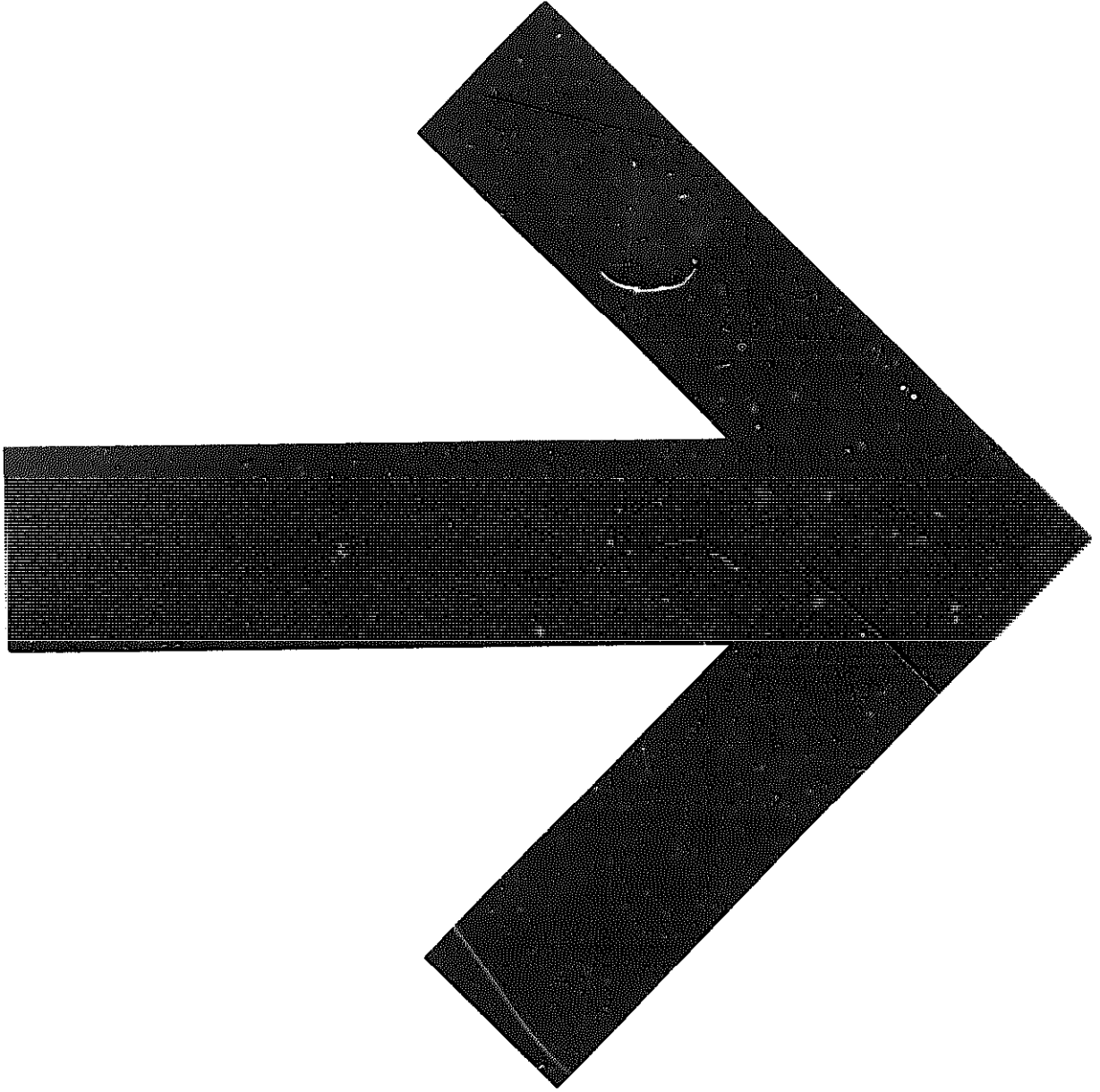

Table of Contents

Appropriate Technology /Teknologi Tepat Guna	5
LP3ES, Pesantren and Appropriate Technology	7
Agriculture /Pertanian	9
Hoes /Pacul	10
Plows /Luku	12
Harrow /Garu	18
P a d d y Weeder /Landak	20
Watering Cans /Gembor	21
Low Maintenance Watering /Mengairi Pohon	22
Water Lifters /Senggot	23
Water Lifting /Waterwheels/Kincir A i r Irigasi	26
Fodder Trees /Penghijauan untuk Makanan Ternak	28
“ P o r t a b l e ” Ducks /Pemeliharaan I t i k	29
Fishing and Aquaculture /Perikanan	30
Fish Farming /Kolam Ikan	31
Raising Fish in Cages /Keramba	3-t
Fish Trap /Bubu	3 6
Fish Trap /Tanggok	37
Large Lift Net /Anco	37
Small Lift Net /Pecak	38
Toss Net /Jala	39
Coastal Fishing /Perikanan Daerah Pantai	39
Fish Processing /Pengolahan Ikan	46
Post Harvest Processing and Cooking Utensils /Pengolahan Lepas Panen dan Perkakas Masak	48
Rice Thresher /Perontok Padi	49
Rice Pounding Watermill /Kincir Air Penumbuk Padi	52
Winnower /Kipas	55
Corn Grinder /Gilingan Jagung	56
Cultured Soybean Cake /Tempe	58
Inoculum for Soybean Cake /Waru	61
Soybean Curd (Tofu) /Tahu	63
Cassava Peeler /Pisau Pengupas Ketela	64
Coconut Processing /Pengolahan Kelapa	65
Coconut Graters /Parutan	66
Coconut Oil Extraction /Produksi Minyak Kelapa	68
Coconut Oil Press /Pemerass Minyak Kelapa	71
Sugar Cane Press /Kilang	72
Coffee Pulper /Pengupas Kopi	73
Fried Crackers /Krupuk	75
Banana Ripening /Pisang	76
Cooking Stoves /Tungku	77
Rice Husk Stoves /Tungku Sekam	79
Kitchen Utensils /Perkakas Dapur	85

Water	Supply /Pengelolaan	Air	.86
Water	Filters /Saringan	Air	.87
Bamboo Hand Pump /Pompa Bambu		8	9
Transportation /Pengangkutan 93			
Shoulder Poles /Pikul .95			
Bicycles /Sepeda .97			
Trishaw /	Becak		.99
Freight Tricycle /Becak Pengangkut Barang	1	0	1
Carts /Gerobak			.104
Homemade Minibus /Oplet .107			
Bamboo Truss	Bridge /Jembatan	Bambu	.108
Architecture, Housing and Construction /Arsitektur,			
Perumahan dan Bangunan			110
Fired Bricks /Bata111
"Red Cement" /Semen	Merah		.112
Pozzolanic Soil	Cement	Bricks /Batako	.113
Wood and Bamboo Preservation /Pengawetan Kayu dan Bambu			.114
Adze /Wadung116
Alang-Alang Grass Roof /Atap Alang-Alang117
Bamboo Reinforced Cement /Bambu Beton118
Acehnese House Design /Rumah Aceh119
Bamboo Implements /Perkakas Bambu .120			
Small Industries, Handicrafts and the Informal Sector /Industri Kecil,			
Kerajinan Tangan dan Sektor Informal .121			
Recycling /Guna Ulang			.122
Used Tires /Ban Bekas .123			
Lightbulb Wick	Lamp /Lampu	Tempel	.124
Fluorescent Tube Wick Lamp /Lampu "Neon" .125			
Blacksmithing /Pandai Besi .126			
Fan-Type Forge Pumps /Ubugan Putar127
Double Acting Piston-Type Forge Pump /Puup129
Other Air Pumps /Ubugan dan Puup Lain133
Tinker's Forge /Ubugan Patri .135			
Silver Soldering /Patri Perak .136			
Spinning Wheel /Pemintal137
Two-Man Grinder /Pengasah	Pisau		.138
Grinding Wheel /Penggosok	Batu	Cincin	.139
Pump Drill /Bor140
Wood Lathe /Bubutan Kayu .141			
Potter's	Wheel / Putaran	Gerabah	.144
Molded Clay	Forms /Pengecoran Tanah	Liat	.145
Tire	Patching /Vulkanisasi		.146
Acetylene	Gas Generator /Pembangkit	Gas	Karbit .148
Electricity Generating Waterwheel /Kincir Air Pembangkit Listrik .150			
Decorative Windmills Kitiran152
Drawing Table /Meja Gambar153
About the Author154

Appropriate Technology/Teknologi Tepat Guna

“Appropriate **technology**” is a term which has almost as many **definitions** as it has practitioners. This book is not an attempt to write yet another definition; rather, it is the result of an approach to the subject which the author and many of his associates feel is vital if appropriate technologies are to play a **role** in the **future** of developing nations: the examination of existing indigenous technologies as the first step in any program which is to involve technological innovation and change.

Appropriate technology is not a specific package of tools and techniques, but rather an **approach** which reflects a particular view of society and technology. It suggests that technology is neither **neutral** nor does it evolve **along** a single path. It recognizes that different cultural and geographical groups **will** have different **technologies** appropriate to their own circumstances; that technological self-determination is essential to cultural identity and political independence. It believes that the only wise technologies are those which seek to suit the specific biological, cultural and economic environment in which they are used.

There is no **well** defined border **line** between **subsistence** and **market** economies. A **significant** portion of the population of many developing nations live in the **grey** area where characteristics of both types of economies intermingle, creating a juxtaposition of survival economics with the modern gadgetry of the 20th century. Villagers still provide for most of their own **needs**, but are not isolated from new innovations and other benefits spread through domestic and international trade.

Most villagers still **manufacture** nearly all of the tools they use. Far from being backward or illogical as is often supposed, most of these traditional tools and systems do in fact have an underlying rationale which has developed in response to local conditions, needs and materials. They reflect the peoples' accumulated expertise acquired over thousands of years.

Throughout history, Indonesia has shown a remarkable talent for absorbing and adapting external influences without necessarily discarding older beliefs. For **2000** years Indonesia has been influenced **by** a variety of religious,

political and commercial forces, representing virtually every Asian civilization that ever existed, and a variety of Western powers dating almost back to the days of Marco Polo. Every nationality which has ever traded, colonized, or taken shelter in Indonesia has made its contribution to Indonesian culture. **though** in most cases it would be difficult to recognize the original form. The Indonesians have selected those aspects and innovations that suit their particular tastes and needs, and then adapted them, creating a new and very Indonesian variety.

Indonesia's indigenous village **technologies** reflect this history. As trade and communication improve and increase, this process of selection and adaptation, or “transformation of technology,” increases also. Indonesian villagers are still creating and producing their own tools, constantly adapting new designs and products, sometimes incorporating manufactured parts, often gathering the modern sector's discards and recycling them into ingenious new devices.

As government and private agencies begin to examine possible roles for appropriate technologies in their community development programs, discussions frequently center upon “transfer of technology”—the adoption of modern technologies from industrial nations for use in communities in developing nations. As explained above, a much **more** complex process, called here the “transformation of technology” is currently taking place in Indonesia's villages, as it has for centuries.

The approach taken by development agencies is often flawed in that by stressing the transfer of modern foreign technologies to villages, the needs and capabilities of villagers are ignored. Modern foreign technologies grew out of the physical, social and economic circumstances of industrialized countries. Many of these technologies have resource-use characteristics, capital to labor ratios, and social organization requirements that make them ill-suited to Indonesia. Indonesian villagers cannot afford the social and economic dislocations that can result from the direct transplantation of such inappropriate technologies.

6 INTRODUCTION

Every culture has a technological tradition and new **technologies** must grow **out** of that tradition. And in the **event** that an entirely new **innovation** is to be **introduced** into a community, an estimation of its **potential** social, economic and environmental impact upon that community is not possible without previous **examination** of the existing situation. Perhaps the best way to become familiar with the factors **determining** the types of technologies appropriate to a given situation is **to study** the technologies already produced and used there. **Probably** the **development worker** will discover that he has **more to learn from the villagers** than the villagers have to learn from him.

This book is the product of such an examination: these are some of the things I've learned.

LP3ES, Pesantren and Appropriate Technology

LP3ES, the Institute for Social and Economic Research, Education and Information, is an independent nonprofit organization aimed primarily at developing young human resources in Indonesia. It was founded in August 1971 with the purpose of assisting the young generation of Indonesians to understand the problems and limitations facing them and their country in the future, and to help them to prepare for that future through programs stressing self-help and self-employment.

There are four programs underway to achieve these goals:

- Research;
- Small Industries Development;
- Pesantren Development; and
- Publications.

Two of these programs are actively involved in the promotion of appropriate technology: the Small Industries Development Program and the Pesantren Development Program.

Since 1973, LP3ES has tried to assist several pesantren (traditional Islamic educational and social institutions) to discover and pursue more active roles in the development of their surrounding communities. Pesantren are an exclusive and influential feature of rural Indonesia, especially Java. Pesantren have been a vital force in the preservation of Indonesian and Islamic values and traditions throughout the history of the nation, and have given rise to a strong sense of "Mandiri," or self-reliance.

Many villagers receive part or all of their education from pesantren. Unlike successful students of government schools who aspire to become teachers, government officials, or workers in the modern business and industrial sectors, nearly all pesantren graduates remain in the villages working as farmers, craftsmen or small traders. There are no other educational institutions which can boast an equal understanding of or quality of communication with their communities.

In the villages, pesantren leaders are as important and perhaps more powerful than local government leaders. The potential for pesantren organisations to lead their communities in ventures promoting self-reliance and

self-direction is one of Indonesia's great resources. LP3ES is attempting to understand and tap this tremendous potential.

Together with the leadership of several pesantren selected for their progressive attitudes and close involvement with community affairs, a small staff at LP3ES is actively exploring ways in which pesantren can become grass-roots level agents of change. Volunteer field workers, selected from pesantren throughout Java, Madura, Sunda and Jakarta, have participated in extensive training programs in community development practices and methods. Returning to their pesantren and villages they have attempted to put their new skills and ideas into action. As their activities began to expand, they soon realized the potential for incorporating various appropriate village technologies into their development programs.

In 1978, LP3ES began drawing up plans for an appropriate technology component for their ongoing program of guidance and support. With Asia Foundation support, they undertook an ambitious program of research, planning and training. This program has concentrated on the existing technologies and basic needs found in the pesantren communities, communication skills, and the examination of simple technologies suited for use in these communities. LP3ES hired Craig Thorburn to assist in the design and execution of this program, and to research and write this book.

Agriculture/Pertanian

Agriculture, in which human beings work to gain food and fiber from the soil through living plants and animals, is the closest interaction between humans and nature. Over the centuries, Indonesian farmers have learned to live with nature's bounty, limits and rhythms, developing a finely-tuned agricultural system in harmony with their tropical environment.

This complex system is constantly changing. Climatic shifts take place, new technologies are invented or introduced, and most important, human numbers continue to increase.

Clear evidence of the effect of increased population on ancient agricultural patterns is often seen in areas where slash-and-burn agriculture has supported a population for centuries. In this system, a small section of the forest is cut and burned off, clearing a plot of land for planting. This land is farmed for 2 or 3 years until soil fertility has decreased to the point that insufficient crops are produced. The plot is then abandoned, a new one cleared, and the old plot slowly returns to forest. In about 20 years, the area has regained its fertility, and can be slashed, burned and farmed again. But in many areas where this technique has been practiced uninterrupted for centuries, increased population is now forcing people to return to abandoned plots sooner, before the land has fully regained its fertility. In such cases the soil quickly becomes so depleted that the forest cannot reclaim it; the land is ruined for farming and the people are forced to move on.

Equally alarming trends are evident in densely populated wet rice cultivating areas. Recent statistics indicate that the national average land holding is .57 hectares per household. It is estimated that a typical family needs to cultivate .7 hectares of good wet rice land to support its basic need. The landless, sharecroppers, and farm laborers are not getting enough to eat, either by their own estimates or by any established statistical measurements.

Traditionally, landless members of a village had the right to take part in the harvest of most rice fields. They would arrive with their *ani-ani* finger knives, used to cut individual

stalks, and harvest as much as they could. They would be entitled to a share (*bawon*) of what they cut. In recent years, however, there have been migrations of landless people following the harvests across Java. Too many people have taken part in the harvests, to the point of negative marginal labor productivity. Losses due to cutting, transporting, theft, and trampling have been too high. Landowners, feeling their traditional roles as patrons becoming burdensome, have increasingly turned to a new harvesting system known as *tebasan*, in which the crop is sold in the field before it is ripe to a harvesting contractor, who hires a small team of harvesters. These harvesters use sickles to cut the rice and are paid in money, not in kind. This approach certainly reduces losses, but has also greatly reduced the distribution of the harvest to the poorest people.

Technological changes also are eliminating agriculture-related employment. More than 2 million women have lost their main source of income as a result of the widespread adoption of small mechanical rice hullers. New "miracle" crop varieties have brought changes to traditional agricultural techniques and patterns. Larger farmers have been able to take advantage of high-yielding rice varieties, while small farmers are endangered by them. New varieties require high-cost inputs of fertilizer, special seed and pesticides, which require small farmers to go into debt. If the crop fails, even partially, the small farmer is forced to sell his land to pay off debts.

The technologies found in the following pages do not form a picture of despair, however. Rather, they illustrate the resourcefulness of farmers who are surviving in a situation which appears to many observers to be nearly hopeless. Here is a glimpse at the remarkable agriculture which is feeding most of Indonesia's 145 million people, despite severe limits on available land and capital.

Hoes/Pacul

The long bladed *pacul* or *cankul* serves the function of the hoe and the spade in Western agriculture. It is used to **turn** the soil, dig trenches, shape banks, weed, mix mortar, scoop **material into** containers, etc. Traditionally made **with** a **wooden** head provided with a steel tip (left), now most *cankui* have blades **made** entirely **from** steel (center). The **example** shown is the type commonly made by village blacksmiths, but cast blades from foreign factories are becoming more popular. An unusual *pacul* (right) features a two-piece steel blade. When the tip wears too short or cracks, only the cuter section is replaced by the blacksmith. This type of construction also allows the tip to be made of hard steel **while** the **neck** section is made of a more flexible alloy.

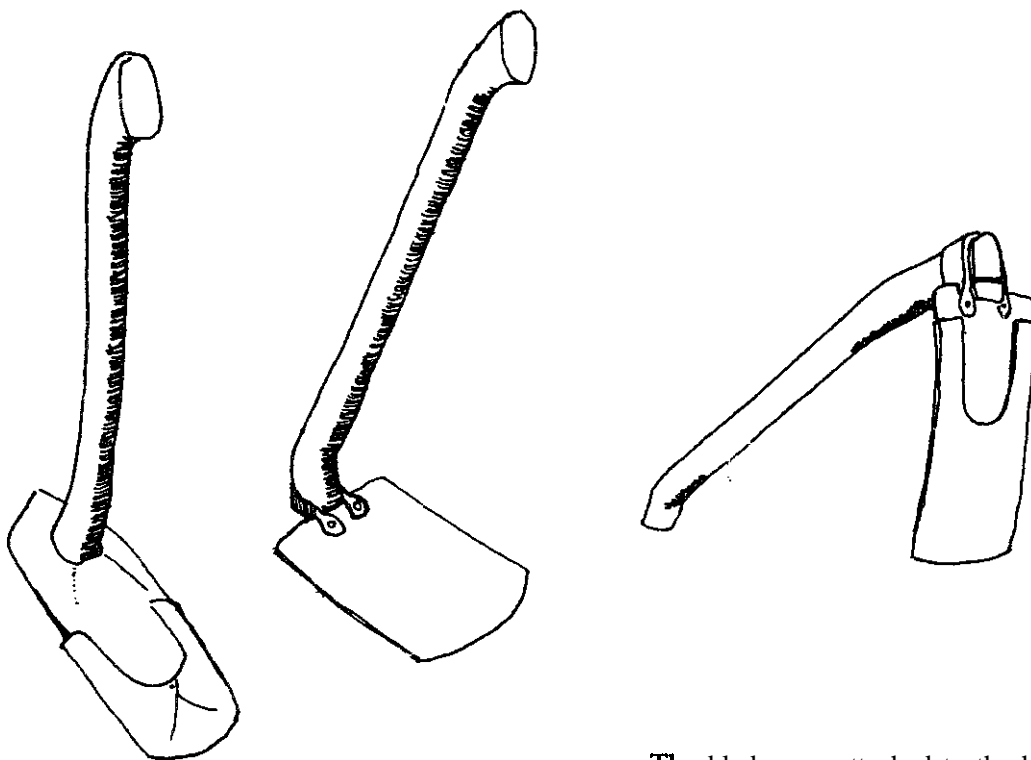

The blades are attached to the handle at a **50** to **70** degree angle. The blades measure **13** to **20** cm wide, **20** to **30** cm long, and weigh **1** to **3** kilograms. **The** handles are usually about a meter long.

Balinese farmers often use a *tambag*, or forked *pacul*. It is lighter and less tiring to swing, and the heavy clay soils of parts of that island do not stick to the forked blade, allowing easier penetration and releasing the blade once turned. The wide-bladed *tambag* is for paddy mud, while the sharp-pointed one is used to break up hard soil.

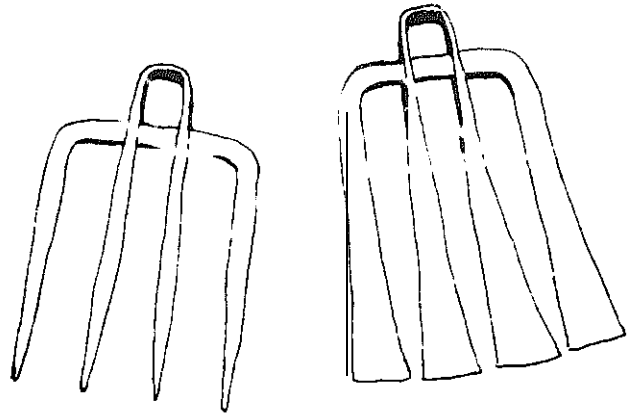

Balinese tambag blades are 15-20 cm wide, and 20-30 cm long. The straight handles are 1 to 1.5 meters long.

Small one-hand hoes with very short handles are called *bengko*. Their light weight and small size provide the control needed to cut weeds growing between crops.

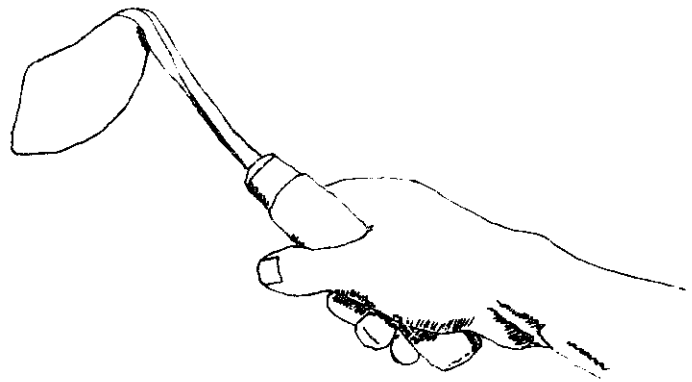

Plows/Luku

Next to the hoe, the plow is the most basic and vital agricultural tool in any culture. The invention of the plow marked a major leap in the productivity of all great ancient agricultural cultures. In some areas of Java, there are terraced rice paddies over 2000 years old. The farmers who cut those terraces plowed their fields with plows very similar to the *luku* or *bajak* still in use by their descendants today.

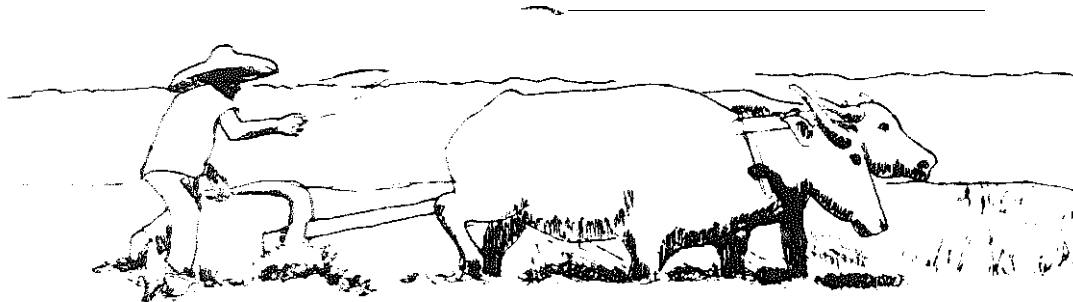

A plow is a bladed tool which is drawn through the soil to prepare it for planting. A true plow lifts the soil, throws it to one side and turns it over. "Ard" is the name given to the primitive predecessor of the plow which breaks the soil into clods without turning it over. Most plows in use in Indonesia are actually somewhere between an ard and a plow; they loosen a 10 to 15 cm wide strip of surface soil to a depth of about 10 cm, and more or less turn it over, exposing the soil to sun, rain and air in preparation for planting. Plowing also tams under grass, weeds, agricultural residues, and manure which then decompose into organic soil supplements.

Indonesian plows differ from Western models in several respects. *Luku* are "unstabilized" plows; they have no guiding wheels to regulate the depth and width of the furrows being cut. Western plows are usually equipped with a furrow wheel in front of, and a land wheel to the side of the plowshare, to guide it through a straight and even furrow. With the unstabilized *luku*, the plowman must use the handle to keep the depth and width of the furrow constant. To be controlled in such a manner, a plow must be light and small. *Luku* are made of wood with steel shares and some-

times steel moldboards, making them much lighter than their all-steel Western counterparts. Indonesian villagers can make and repair their own wooden *luku*. Wooden *luku* have a large block, or *bantalan* which forms the main body of the plow: steel Western plows do not have this feature. Also, most Western plows have a "coultter", a knife pointed downward which precedes the share and cuts the edge of the furrow: *luku* do not have such a blade.

The shape, size and construction of plows differs significantly between one region and the

next throughout Indonesia. If asked why a plow is made in a certain way, the farmer inevitably answers, "because it is suited to the soil here." A complete inventory of different *luku* and an examination of their performance in different types of soil is beyond the scope of this book. Instead, a description of each of the plow parts and their functions and a look at a few different types of *luku* should provide a basic understanding of this vital tool.

The essential parts of a *luku* are:

1. The *pasangan* (harness) fits over the necks of the draft animals. Oxen or buffalo are used, usually in pairs. A single animal can be used in areas with light soil which breaks and turns easily, 80 cm wide for one animal, 1.5 meters wide for two animals.

2. The *cacadan* (beam) connects the plow body to the harness. It is about 2-2.8 meters long, enough to keep the blade away from the heels of the animals, but short enough for tight corners. The harness is tied onto the beam, which has either a peg or notches called *golang-galing* located near the end.

3. The *bantalan* (block) is the plow body. It helps to guide the *luku* through the soil. The relationship between the block and the beam is crucial: when the beam is connected to the draft

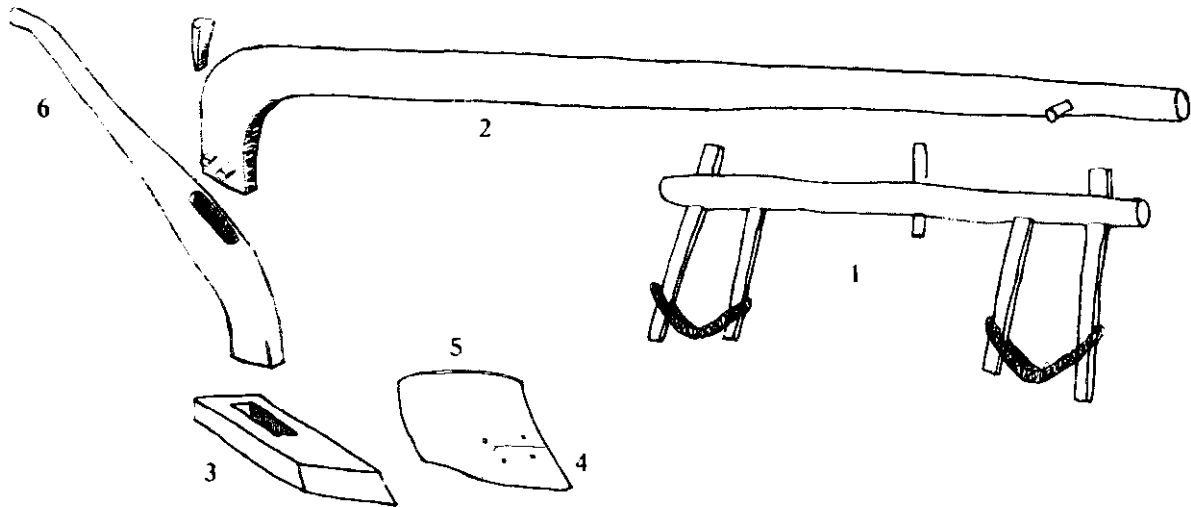

animals, the block must sit flat in the bottom of the furrow. When pulled out of the furrow and set upon unplowed land, the block should point slightly downward. The block is typically 6-10 cm thick. Long narrow blocks (10-15 cm wide and 40-60 cm long) are used for hard uneven soils: this helps the plow pass straight and evenly through the soil. Plows for wet paddy soil have very wide blocks (20 cm wide and 30-40 cm long) which help prevent them from sinking in the soft mud.

4. The plowshare (*mata* or *kejen*) is made by local blacksmiths from hardened steel. Many Indonesian *luku* have spear-like points: these are 8-12 cm from point to back, 8 cm wide at the back, and 65 cm high at the back. *Luku* for wet rice paddies or very soft soil have flat sides and the triangular or trapezoidal share familiar on Western plows: these are about 6 cm on the sides and 8 cm on the top and bottom, riveted and/or welded to the moldboard.

5. To turn the soil, or at least break it up and throw it to the side, a plow must have a moldboard or *singkal* behind the share (actually an extension of the share). On many *luku*, the *singkal* is carved from one piece of wood with the block, forming a sort of wing on the front of the block. This is the plow part which differs most between different regions. Size, shape

and angle vary considerably. Long *singkal* turn the soil without breaking it into small clods. This is best for burying weeds, green manure, manure, chaff or fertilizer. But because the plow is supporting so much soil it becomes heavy for the animals and the plowman. Also, clay soils stick to long *singkal*. For heavy soils the *singkal* slants sharply back, nearly parallel with the direction of plowing. Soils with little cohesion, such as sandy loam or the soft mud of rice paddies, crumble apart or slide off before they can roll over on a long *singkal*. Plows for these types of soil have a much shorter *singkal* set at a larger angle away from the direction of plowing, often with a concave cylindrical shape. Such short *singkal* break up the soil and can only partly turn it over. As stated earlier, most *luku* are technically between a true plow and an ard. The shape, size and angle of the *singkal* in each region has developed over centuries of use and represents a compromise, turning the soil as well as possible with a *luku* which can be drawn with local animals and handled by a plowman of small stature.

6. The single handle (*ekor* or *buntutatan*) has a curved end to provide a grip parallel with the ground, at a height considered comfortable and operable. Different regions have handles at thigh, waist or even shoulder level.

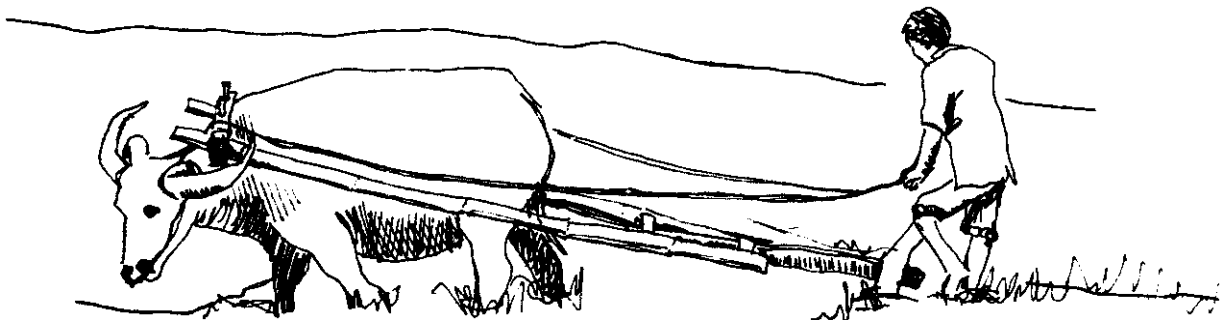

Following are descriptions of different types of *luku* found in widely scattered areas:

The **Acehnese *luku*** is among the most primitive still in use. A small spear-shaped steel tip fits in a **slot** through the triangular block. The dry land model. (block only on the left, and fully assembled on the right) is a crude ard. The wet rice paddy model has a short **wooden *singkal*** at a **sharp** angle which throws some of the soil to the side.

*Acehnese luku
for dry land*

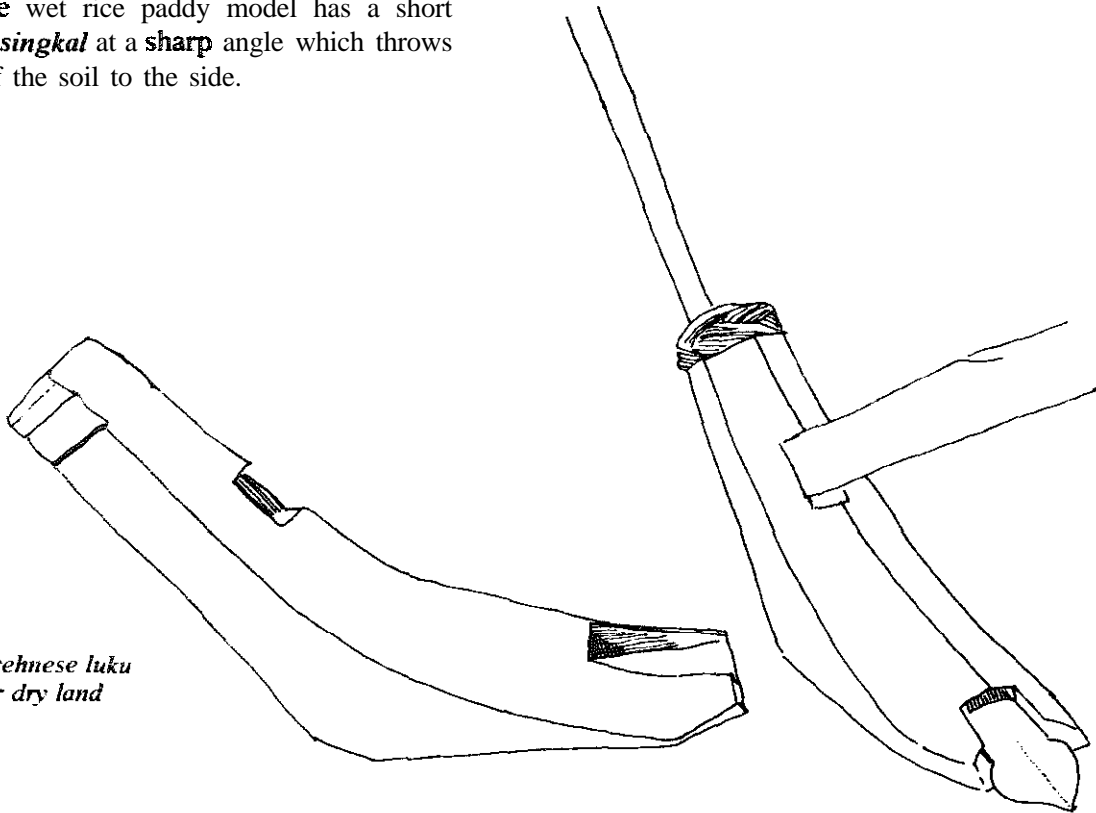

*Acehnese luku
for wet land*

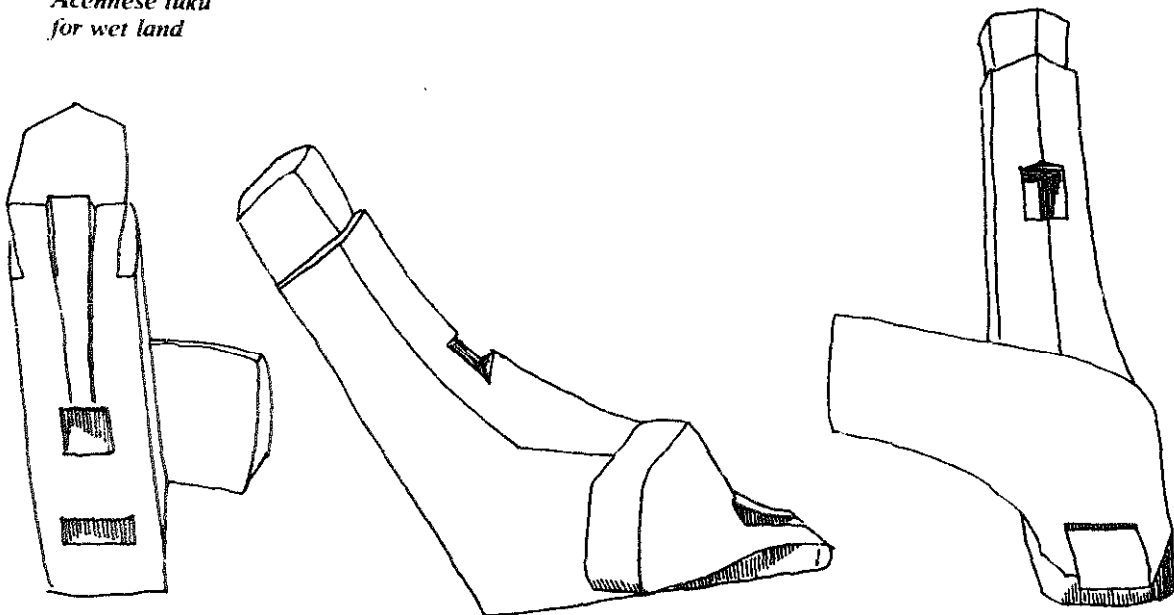

The *luku brujul* found in the barren rocky areas of Central Java's southern mountainous regions is also an ard. An almost cone-shaped steel point fits over the outside of the pointed tip of a long thin block. The long handle slants sharply back, providing the plowman with greater leverage to try to guide the *iuko* through the thin, stony soil.

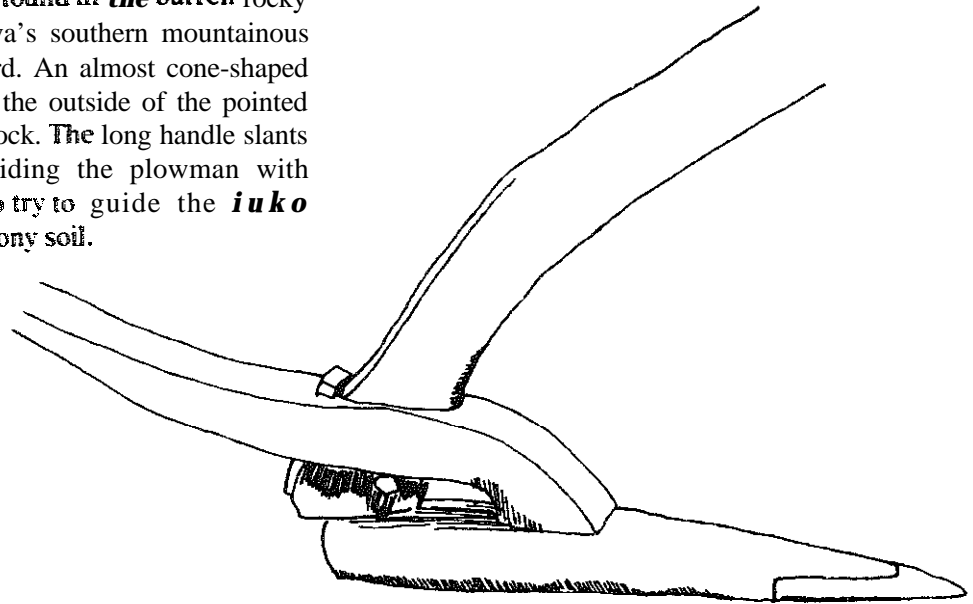

A similar type of *luku* is found in Madura, another region with poor soil and insufficient rainfall. The shape is almost identical to that of the Javanese *luku* above, the only major difference being that the Madurese *luku* has a wooden *singkal* to lift the soil and throw it to the side. The block is made from two pieces of wood, the forward piece holding the share and including the small *singkal*, and the rear piece curving upward to become the handle. Many Madurese farmers prefer very tall handles that reach up to their shoulders.

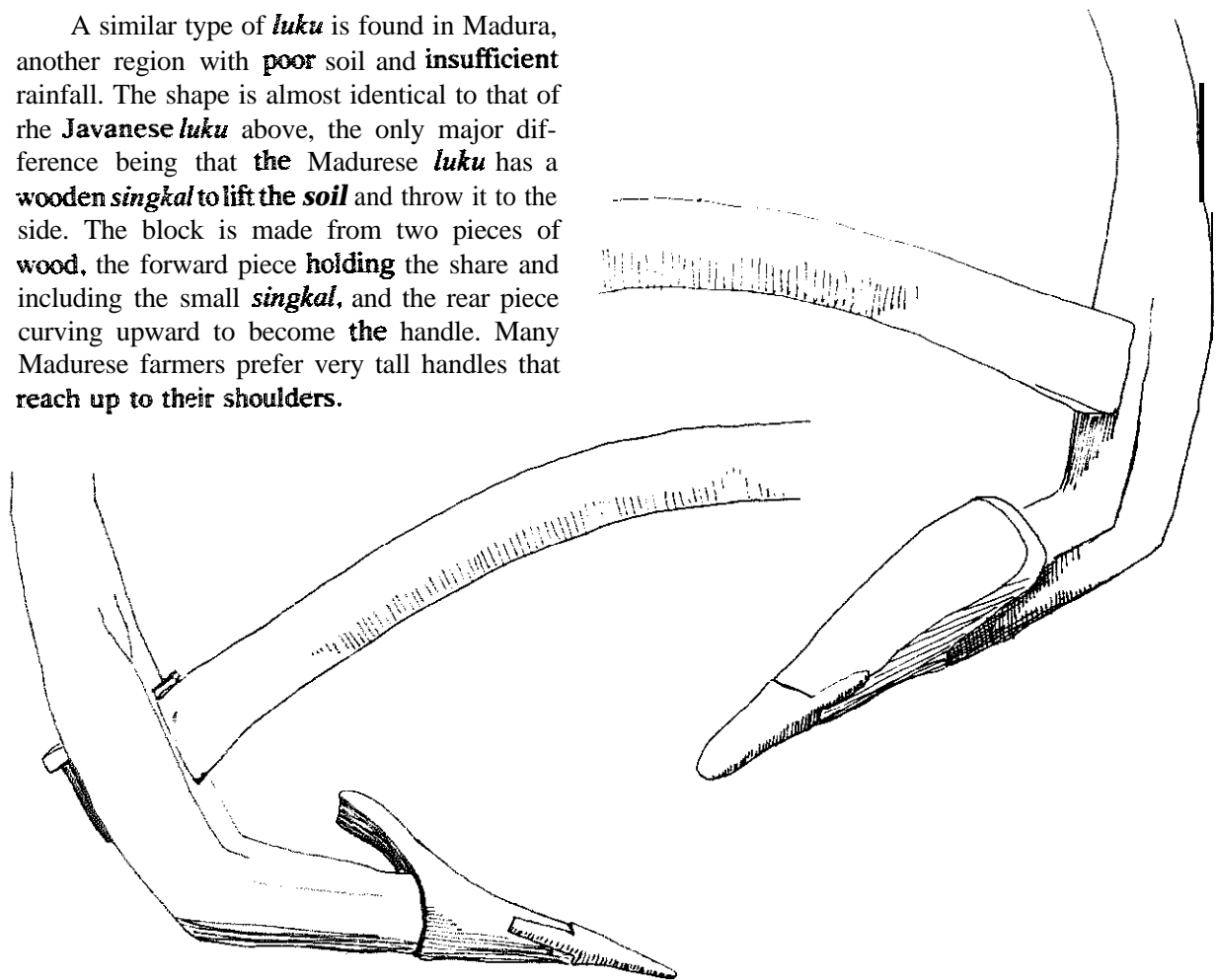

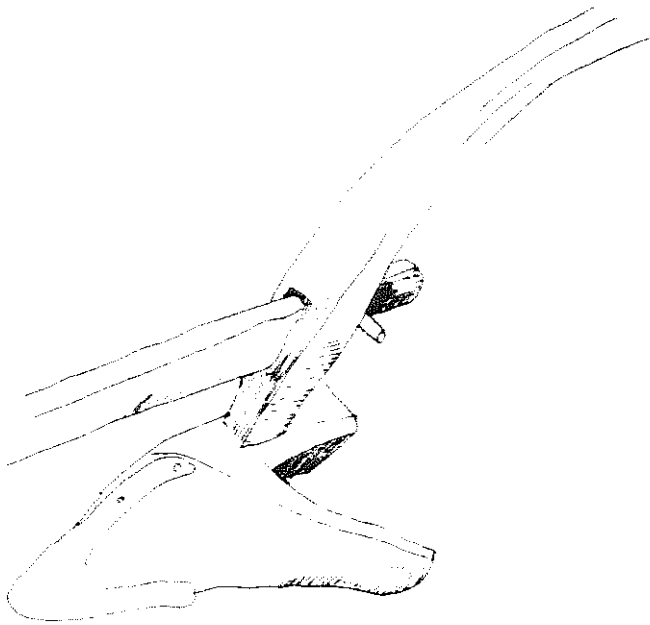

This Sundanese wet land *luku* is the first true plow examined in this text. The triangular share cuts a furrow slice which is drawn up and turned by the long wooden *singkal*. The opposite side of the block is straight and slides along the edge of the newly-cut furrow. On the *luku* illustrated here, the block and *singkal* are cut from a single piece of wood. Some versions have a separate *singkal* joined to the block with wooden pegs.

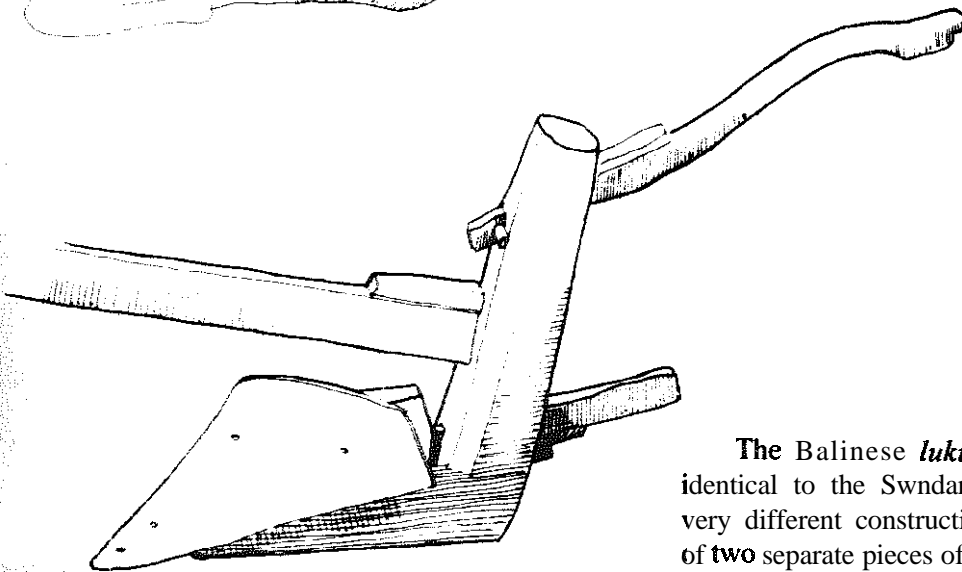

The Balinese *luku* has a shape almost identical to the Swndanese *luku* above, but a very different construction. The **block** is made of **two** separate pieces of wood. The larger piece curves up to connect to the beam and the handle. The smaller piece of the block, held in place by a complex array of mortise and tenon joints and wedges, in turn holds the share and *singkal*, which on this example are made from a single piece of steel.

When asked why the design seems so complicated, a Balinese farmer answers, "Because it is supposed to be that way."

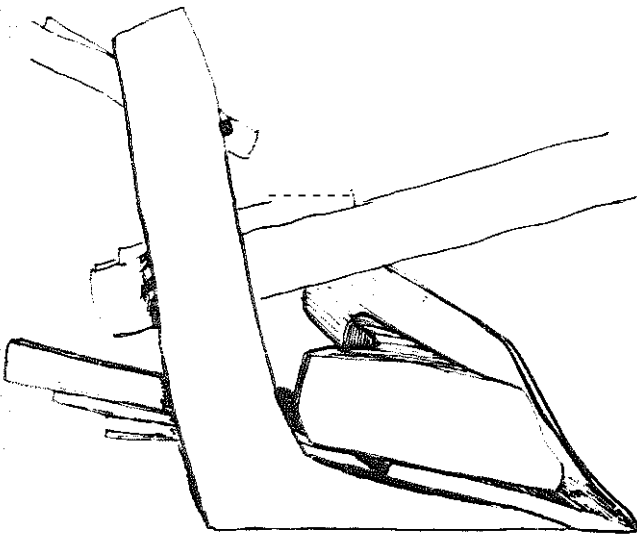

The Central *Javanese luku maluwik* has a trapezoidal share and a large, steeply angled *singkal* for turning the **soft smooth** paddy mud of that region. Note the **very** wide block which keeps the *luku* from **sinking too** deeply as it is pulled through **the soft** mud. **This** elegantly designed *luku is, in the words* of one *Javanese* farmer. "the best, if your soil is good enough for it."

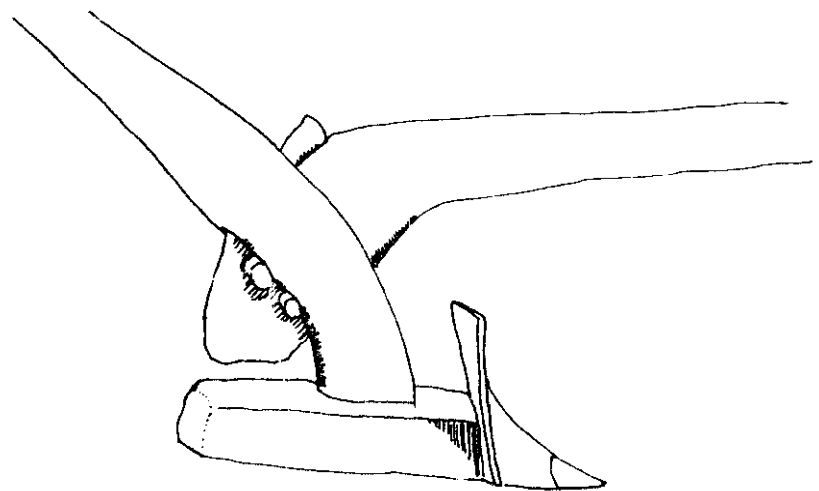
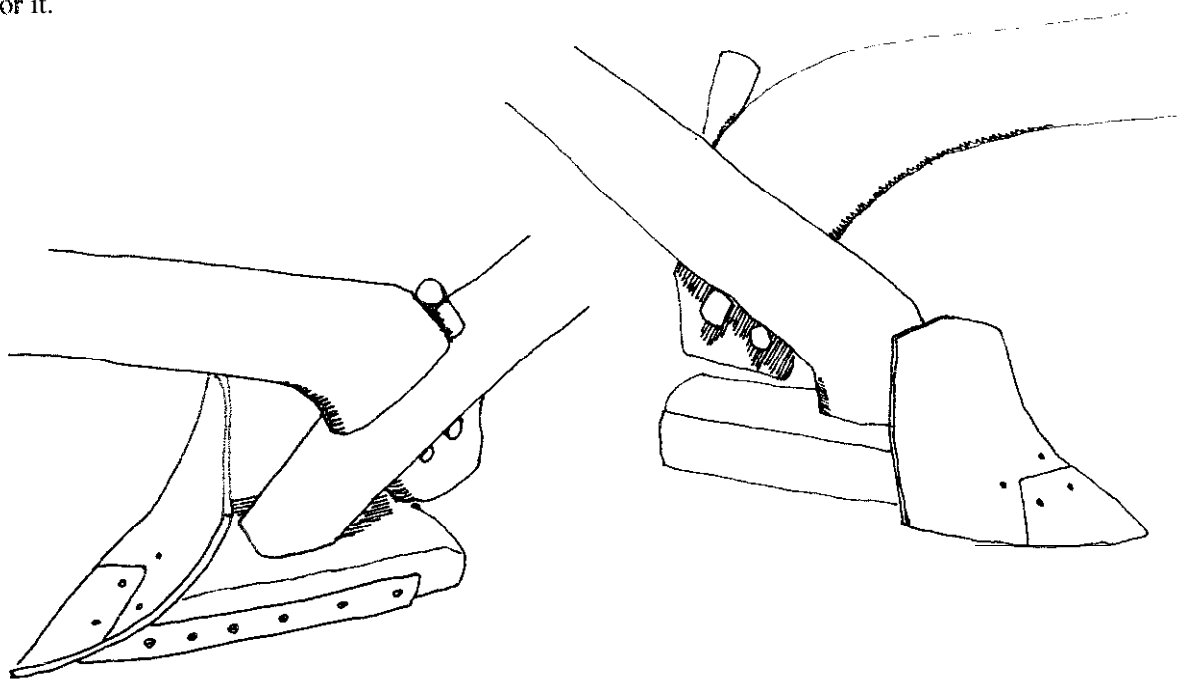
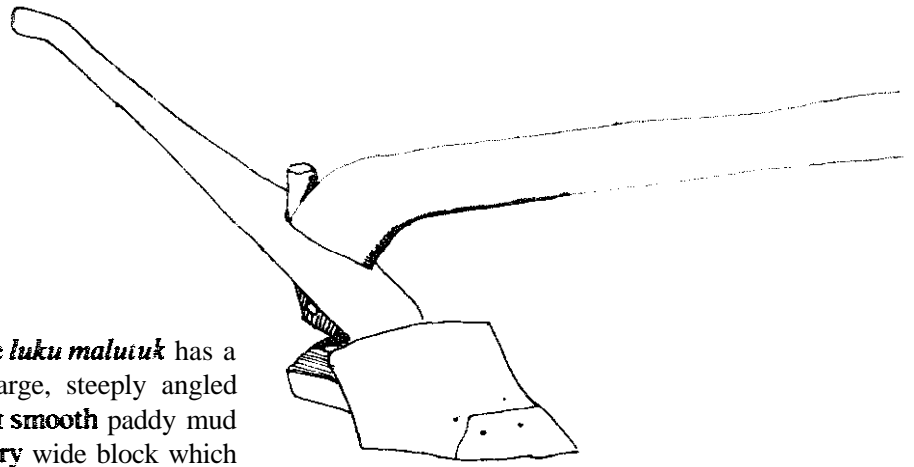

Harrow/Garu

After plowing, the soil is not yet ready for planting. It is in large clods, lined with uneven furrows and ridges which must be levelled, and contains many large weeds not broken up during the plowing. If time allows, it is beneficial to leave the soil fallow for a few weeks so that weeds can germinate, and then be tamed under with hoes before planting. But intensive farming methods often require that the soil be prepared for planting immediately after plowing.

To break up the clods and smooth the soil, a toothed harrow, or *garu* is used. Drawn across the field by animals like a *luku*, the *garu* has a board about 1 to 1.2 meters in length fastened perpendicular to the end of the beam which drags across the soil. Protruding from the bottom of this board are 6 to 20 teeth which cut through the soil, breaking up the clods and evening the surface.

Because the *garu* are very light, the plowman often sits on the handle to give the tool greater weight as it is pulled across the soil.

Garu differ slightly from region to region: usually these differences are not as pronounced as with the *luku*. Besides varying in number, the length of the teeth ranges from about 10 to 20 cm. Some farmers are now making *garu* with steel teeth instead of the traditional hardwood.

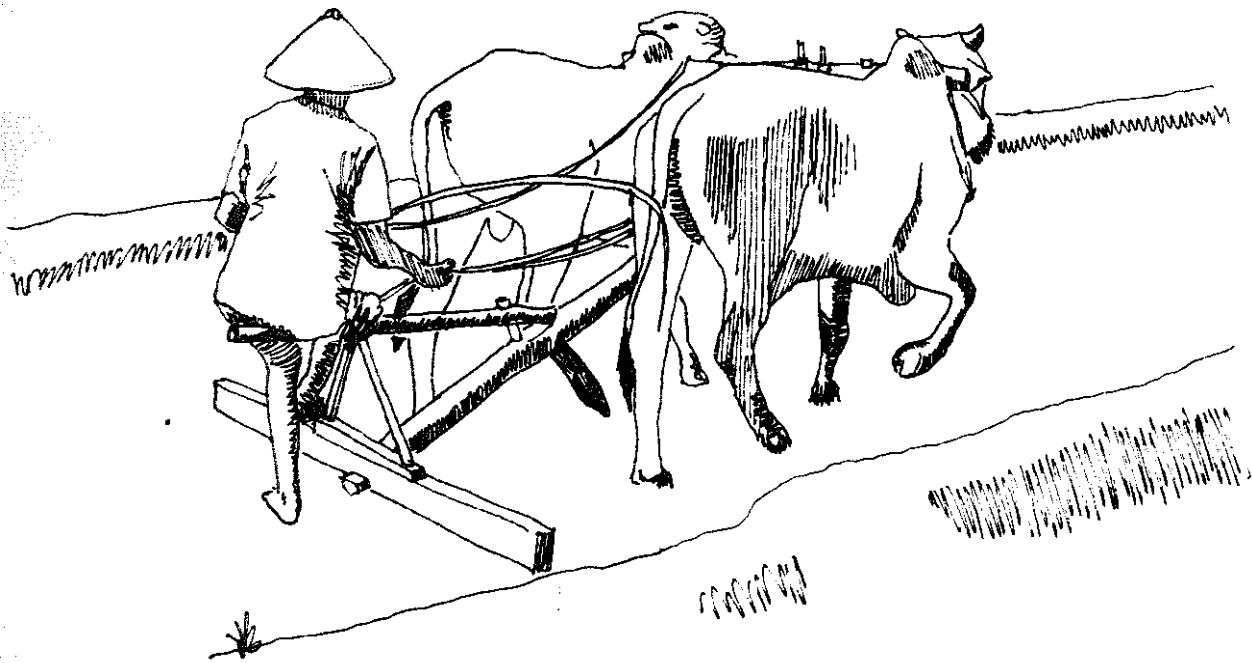

Sometimes the beam is made from bamboo, like the **Sundanese garu** to the right, but more often it is made from wood, like the **Javanese** model below. The bamboo type is lighter, but the wooden **garu** is certainly much sturdier and longer-lasting. Light weight is important not only for transporting the **garu** to and from the fields, but also for turning it around in tight corners and lifting it up and down between terraced fields.

Sundanese harrow

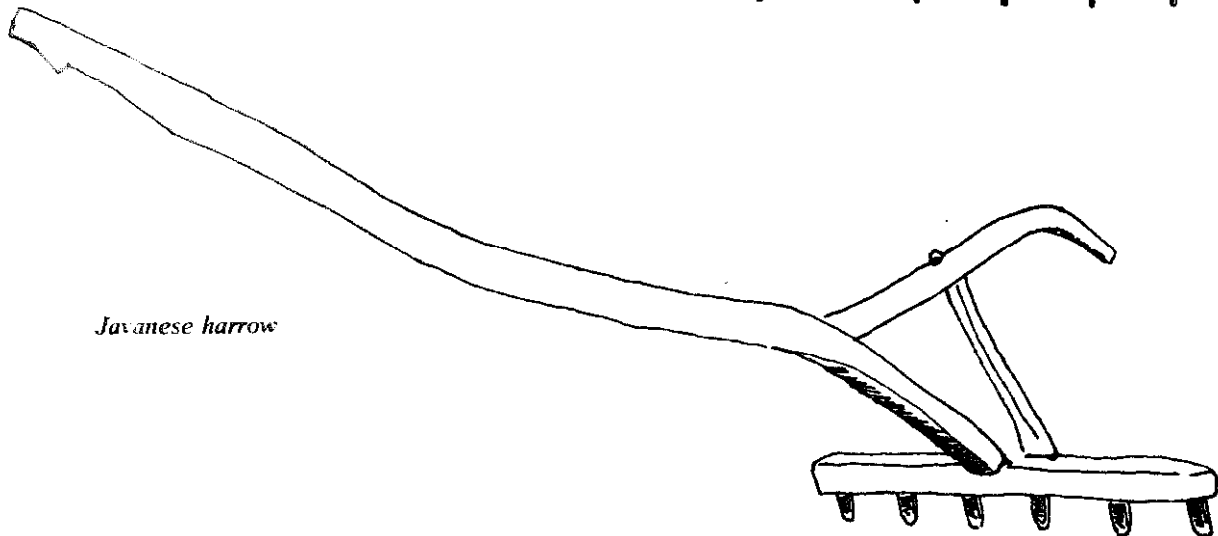
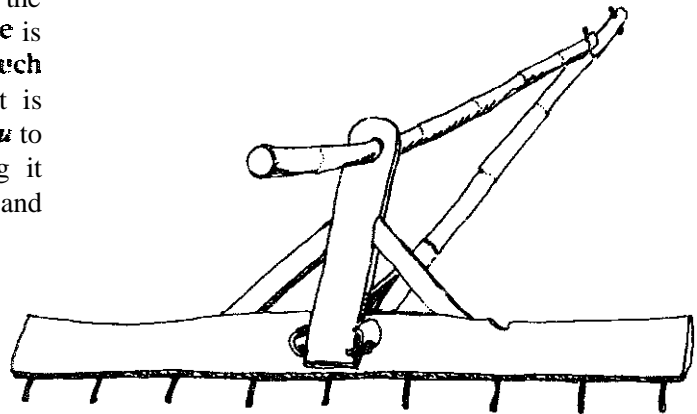

Javanese harrow

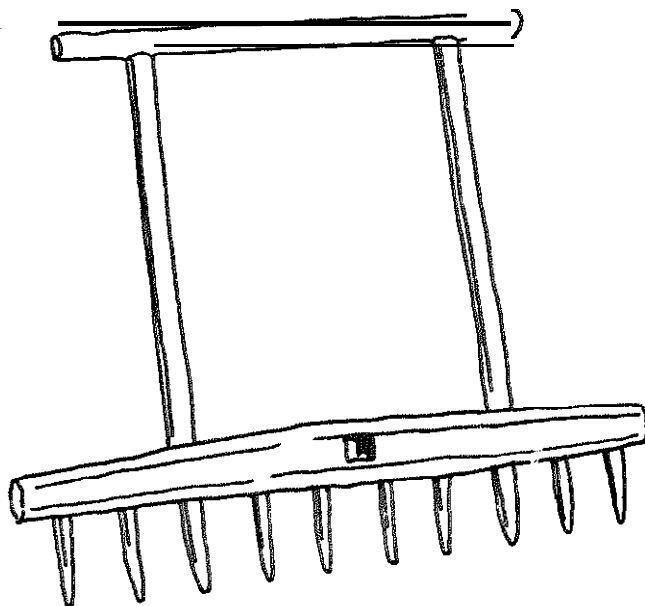

The **Acehnese garu**, shown here without the beam attached, differs from those found on Java; the handle is parallel to the toothed beam. This configuration resembles the harrows of the Southeast Asian peninsula.

Acehnese harrow

Paddy Weeder/Landak

In most irrigated paddy areas of Indonesia, farmers **plant** the rice in straight, evenly spaced rows. In this manner the plants are guaranteed sufficient space for proper root and leaf growth, and the maximum number of plants can grow in the available space. Another significant advantage of planting rice in rows is that the field can be **easily** weeded with a tool. Rice paddies must be weeded twice, 3 and 6 weeks after the young shoots are transplanted. After that the rice **plants** are tall enough to shade out competing weeds.

Weeding rice paddies by hand is a tedious and **time-consuming** task. **There** are a variety of tools which can be pushed down the spaces **between the rows of plants**, performing the task quickly and **efficiently**. **The best** of these tools is the **landak**, introduced by the Japanese during their occupation in the Second World War. The **landak** consists of 3 parts:

1. The "head" of the **landak** is a wooden drum, either cylindrical or with a rounded star cross section. The drum is **15 cm** long, with a diameter of about **12 cm**. **In** this drum are set 6 or more rows of **slim flat** steel teeth. These teeth

3. The frame is nailed onto a long wooden or bamboo handle. A **"T"-shaped** crosspiece at **the end** of this handle facilitates use of the tool. The handle is **1½ to 2 meters long**, depending on the height and preference of the operator.

To **weed** the paddy, the operator **places** the head of the tool **between** the rows of **rice plants** so that the steel spikes are curving back toward him, opposite the direction of the drum's rotation when the tool is pushed. He then walks down the row, pushing the **landak** forward about half a meter with each step, then jerking it back a few centimeters before taking another step and pushing the **tool forward** again. In this manner, most of the weeds and grass are destroyed and buried beneath the soft mud.

If the paddy is left too long before weeding, and the weeds are allowed to reach a height of more than a few centimeters, the **landak** cannot perform well. Weeds growing in fertile paddy fields for more than 3 or 4 weeks become large enough to get entangled in the tool's teeth. If the weeds are allowed to grow too big, the paddy must be weeded by hand.

are about **10 cm** long, and are curved to form a quarter circle. **There** are 4 or 5 teeth in each row, **all** curving in the same direction.

2. The head is held by 2 nails **serting** as an axis in a rectangular wooden frame, measuring about **20 by 30 cm**.

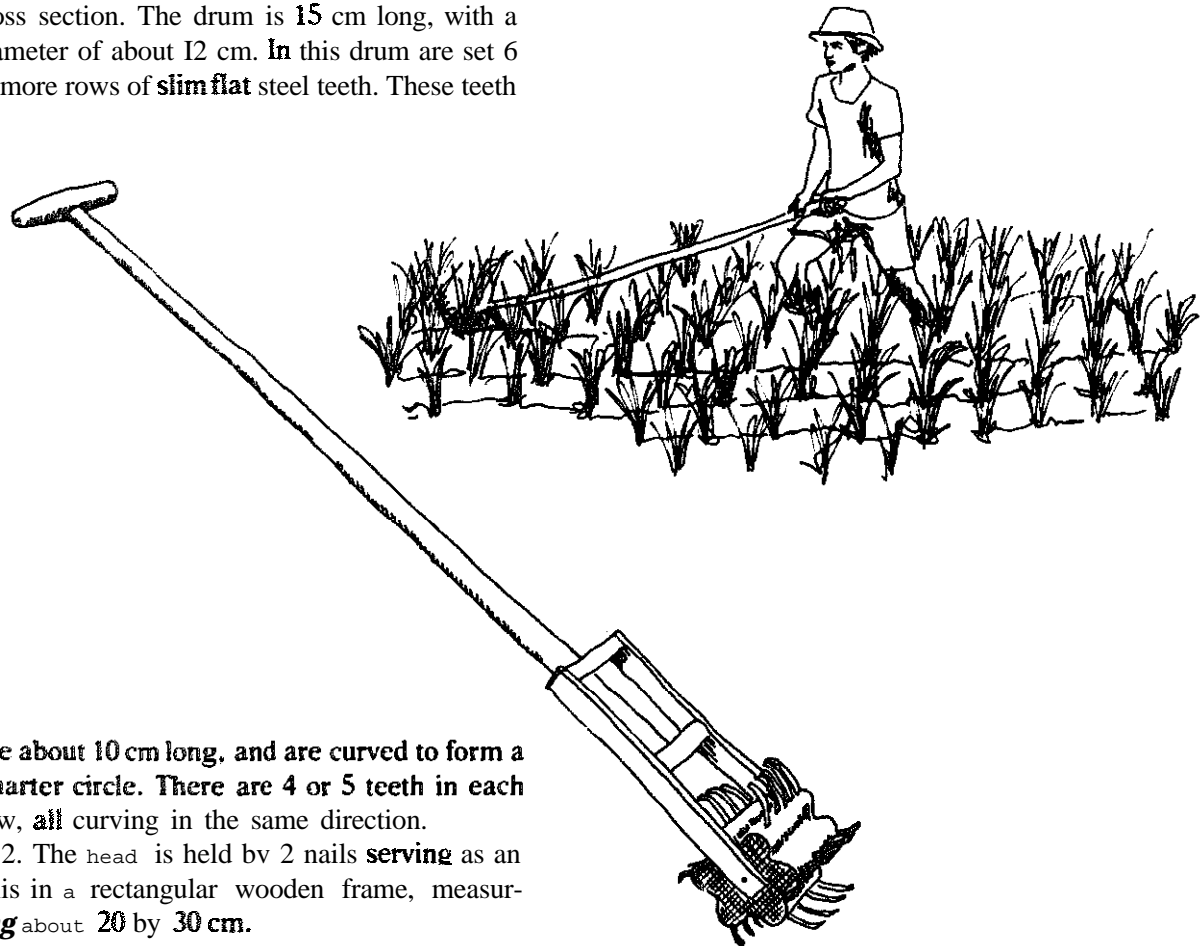

Watering Cans/Gembor

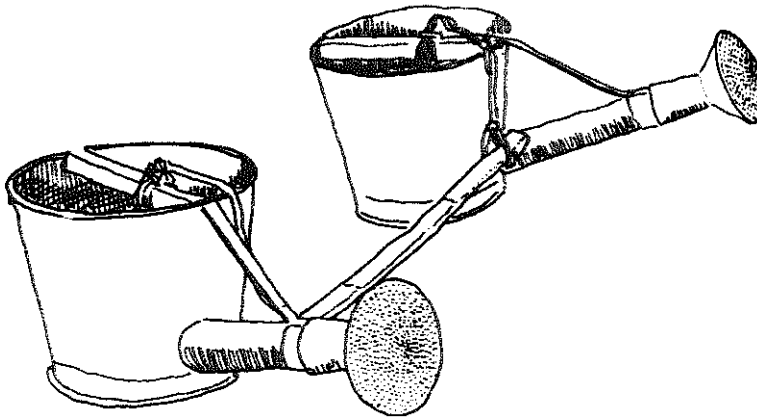

The ends of the sprinkler pipes of the gembor are level with the tops of the water cans.

Many varieties of vegetables and cash crops will wither and die in a few days if they don't get water. Therefore, in the dry season, these plants must be watered regularly. Sprinkling the soil around the plants is an efficient way to water, using much less water than flooding ditches around the rows or mounds upon which the plants grow. If water must be lifted or carried to the fields, sprinkling is often the only alternative. The *gembor* is a tool used on the island of Java for sprinkling crops. The *gembor* has two parts:

1. Two large cans, either buckets or rectangular paint cans, hold up to 15-25 liters of water each. A pipe is fitted at the base of each can. At the ends of these pipes, level with the tops of the cans, are fitted large perforated sprinkler heads. The cans, pipes and heads are all made of soldered sheet metal. Material cut away from oil or asphalt drums is best for this purpose. The slightly domed sprinkler head is perforated with 100 or more nail holes. A wooden or iron handle is attached to the top of each can.

2. These cans are hung by ropes from both ends of a bamboo or wooden shoulder pole. Shoulder poles for *gembor* are usually about 1 meter long, shorter than those used for transporting goods over long distances.

After the cans are filled to the top with water, the *gembor* is carried to the field. If the water source is far from the field a farmer may use less cumbersome vessels to carry the water to the field, where he can pour it into the *gembor*. Walking between the rows or mounds of plants, the farmer holds the handles on the tops of the cans and tilts them forward gently. The farmer keeps walking as he sprinkles either one or both rows of plants.

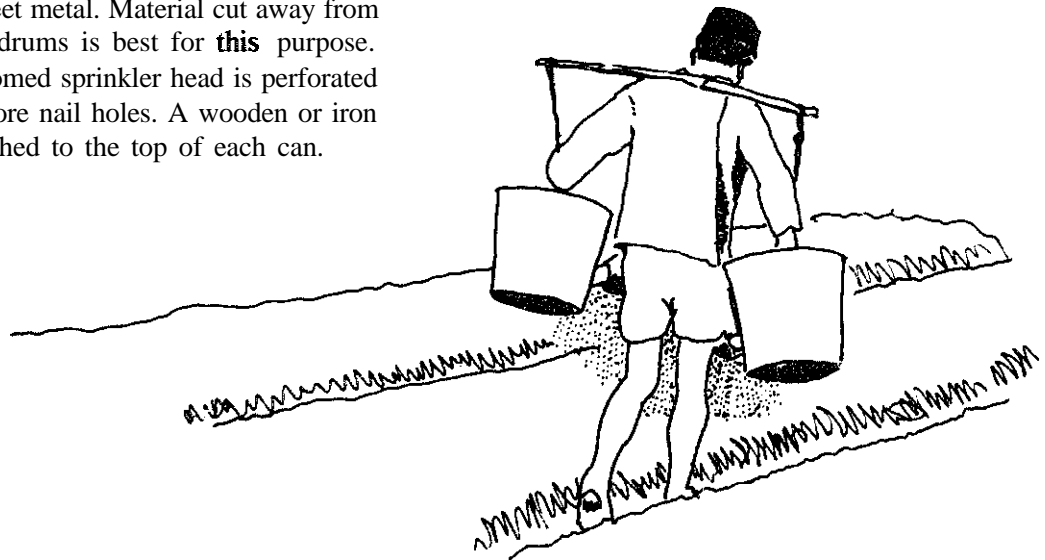

Low Maintenance Watering/

Mengairi Pohon

Seedlings, young **trees** and **fruit** trees with **shallow** roots require constant watering. Most Indonesian villagers **realize** that trees are important, preventing erosion and providing shade, fodder, firewood, or **fruit** which can supplement **their** diets or incomes. **But** for poor hard-working **villagers**, the intensive **main-**
tenance effort necessary often outweighs **the** **potential** benefits of planting trees. **In** a few places **in Java**, farmers have discovered a "semi-automatic" watering system that greatly reduces the number of times **that** trees must be watered through the dry season.

Two, 3 or 4 unglazed earthenware **cookpots** are used to hold and slowly release the water into the soil around the trees. New pots, or cracked pots which have been patched with pitch or tar are buried part way into the soil around the tree, about **40 cm from the** trunk. **The** pots are **filled** with water, which slowly seeps through the porous clay **walls**, keeping the soil around the tree moist. During periods of no rain, the pots are checked and refilled every 3 or 4 days.

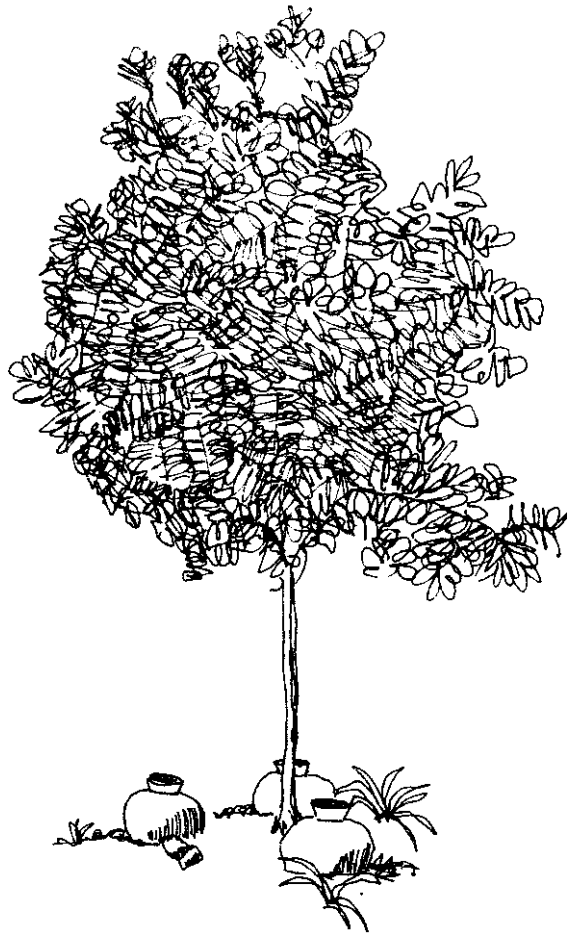

Water Lifters/Senggot

Indonesia has some extensive and intricate irrigation systems, some of them dating back several centuries. Since early in the 20th century, there has been a massive expansion in the country's irrigation networks. But a great deal of the country's arable land is not serviced by irrigation canals, either because the expansion has not yet reached all areas, or because the local topography does not allow gravity-flow irrigation. Therefore water must be mechanically lifted to water rice paddies, vegetables and cash crops during the dry season. Salt producers also commonly lift the sea water into their drying pans. For these purposes, there are a number of different water lifting devices employing levers called *senggot*. Three different types, each with different lift capacities are described below.

In areas with a water table more than 2 or 3 meters below the surface and no sources of surface water, dry season rice farming is impractical. Instead, vegetables and cash crops are grown. Water to sprinkle these crops must be carried over large distances or raised from wells. The *senggot* commonly used to raise water from wells employs a long lever with a fulcrum high in a tree or on a pole. The fulcrum is placed 3 to 6 meters above the ground, and the lever is 4 to 8 meters long. One end of the

lever is weighted with a basket or old tire filled with stones or pieces of iron. The opposite end, situated above the mouth of the well, is tied to a long rope or bamboo pole which drops into the well as that end is lowered. At the bottom is a 10 to 20 liter bucket which is dropped into the well and lifted to bring the water to ground level.

To till the bucket, the operator pulls down on the pole or rope, guiding it into the well with a rapid hand-over-hand motion. At first the operator must give fast, strong pulls, but as momentum is gained and the counterweight

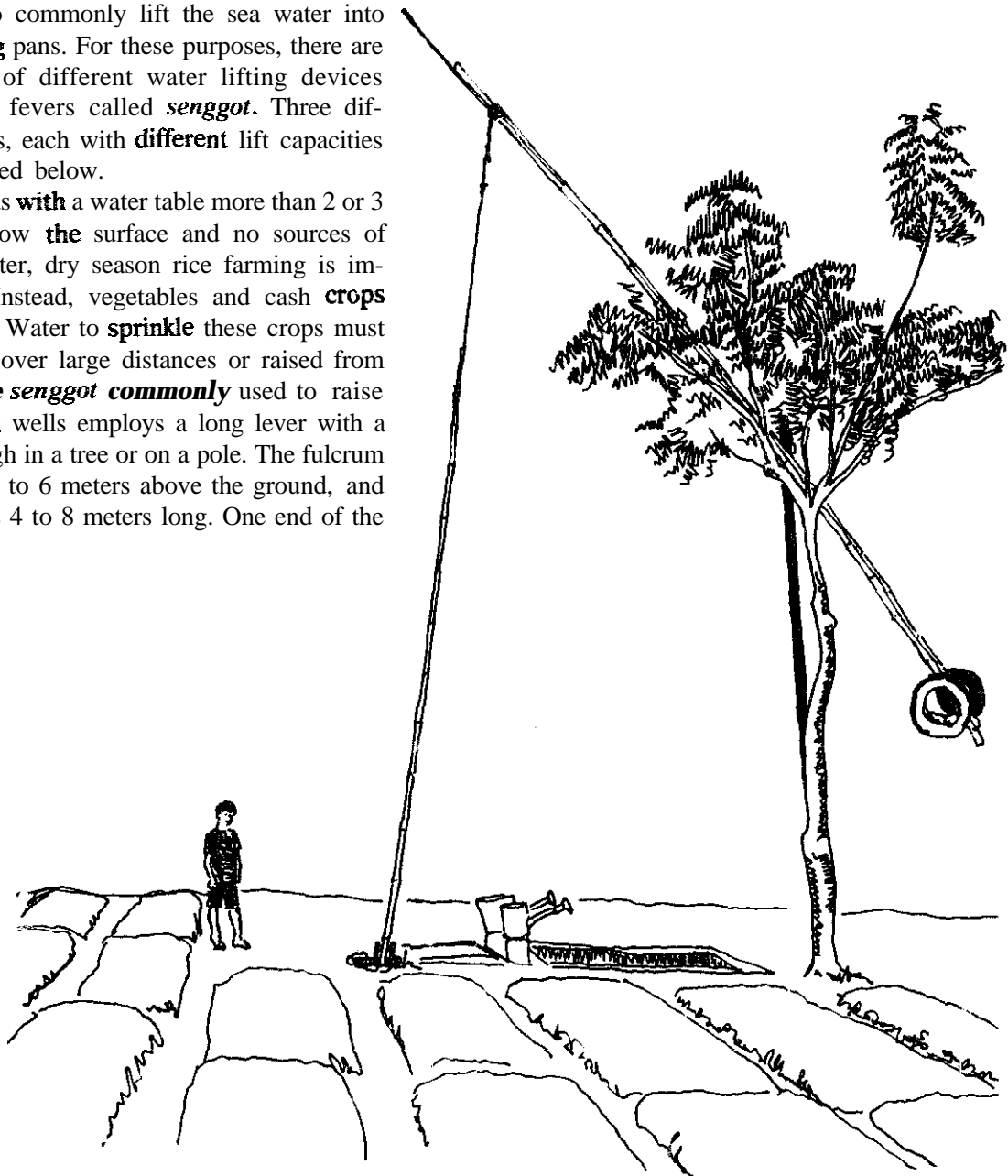

arcs upward, the bucket plunges downward on **its own**. Once the bucket is filled with water, the operator reverses the process, giving the pole a few strong upward pulls to send it rushing up into his hands.

When bamboo poles are used, the bucket can be attached with pin hinges so that it can be easily emptied using one hand. If rope is used, the bucket must be grabbed with both hands to pour out the water.

This type of senggot can be used in hand-dug wells up to 6 to 8 meters deep, and raises water much more quickly than pulley or crank systems. The senggot shown above lifts 15 liters at a time from a 7 meter well. The level is $5\frac{1}{2}$ meters long. The 25 kg counterweight is placed 2 meters from the fulcrum, while on the opposite end of the lever, the 10 meter rope and pole holding the bucket is fastened 3% meters from the fulcrum. The fulcrum is $5\frac{1}{2}$ meters from the ground. For smaller or larger senggot, the proportions remain the same.

Another type of senggot is used to raise surface water between 50 cm and 2 meters. The fulcrum, located at the mid-point of the lever pole, is 50 cm to 1 meter above the ground, at the top of a bamboo or wooden "X", or a "Y-shaped branch or stump. Water is scooped up and lifted in a large basket or pan, about

Bucket attached with pin hinge.

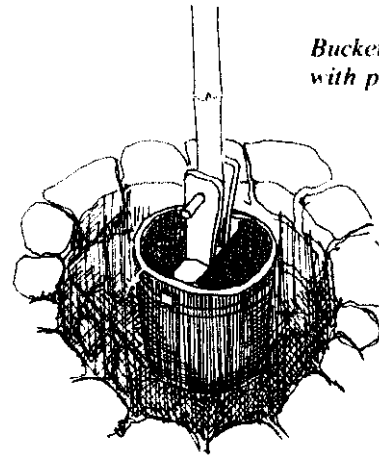

twice as wide as it is deep. This container can hold 20 to 30 liters of water. The operator holds onto a "T"-shaped handle, lifting it over his head to plunge the opposite end into the water. Then he pulls his end down to lift the water. As soon as it is high enough, he swings the lever towards the bank and twists the handle to dump the water into the ditch, rice paddy or salt pan.

Although this type of senggot is limited to 2 meters lift at the most, and the work is very tiring, it can lift large amounts of water, tilling a 5 by 5 meter paddy field or salt pan in just 2 or 3 hours.

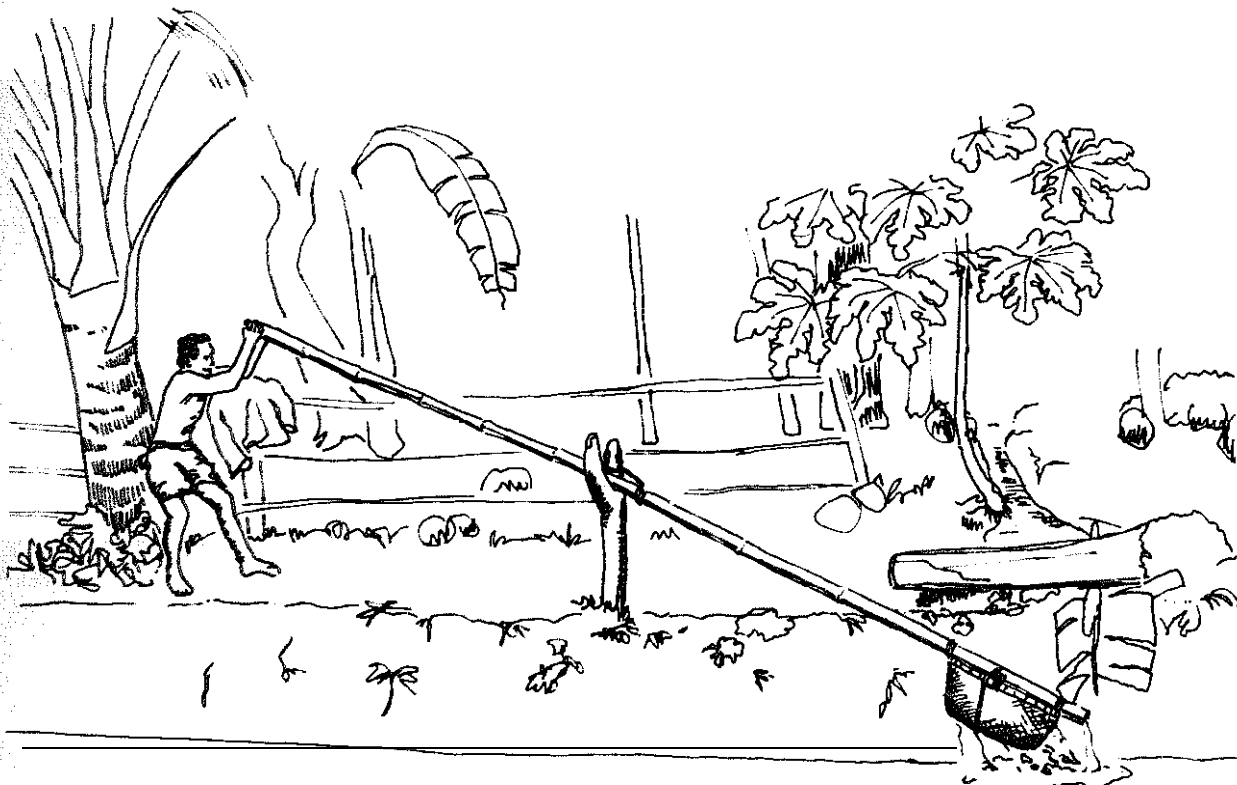

The third type of *senggot* is used for even lower lift applications, up to 50 cm. A small 10 liter pot, bucket or basket on its side is lashed to the bottom of a lever hanging from a tripod. The top of the container is just above the water level of the stream, pond or canal. The handle is split in two and lashed onto the sides of the container. A "T"-shaped piece on the end of the handle makes polling easier. The operator stands in the secondary ditch or paddy and pulls the *senggot* with a rapid back and forth motion. Each tug of the handle pulls a wave of water into the ditch or paddy.

The lift capacity of this type of *senggot* is extremely limited, but for very low-lift applications- it is perhaps the easiest of these technologies to use, requiring less strength and physical exertion than either the long-lever *senggot* described above, or the direct use of buckets.

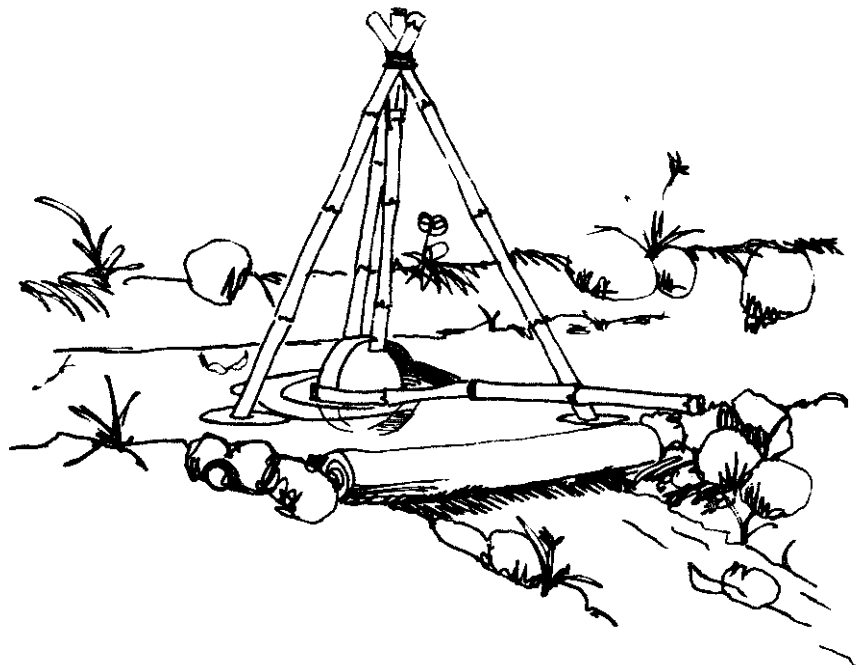

Water Lifting Waterwheels/ Kincir Air Irigasi

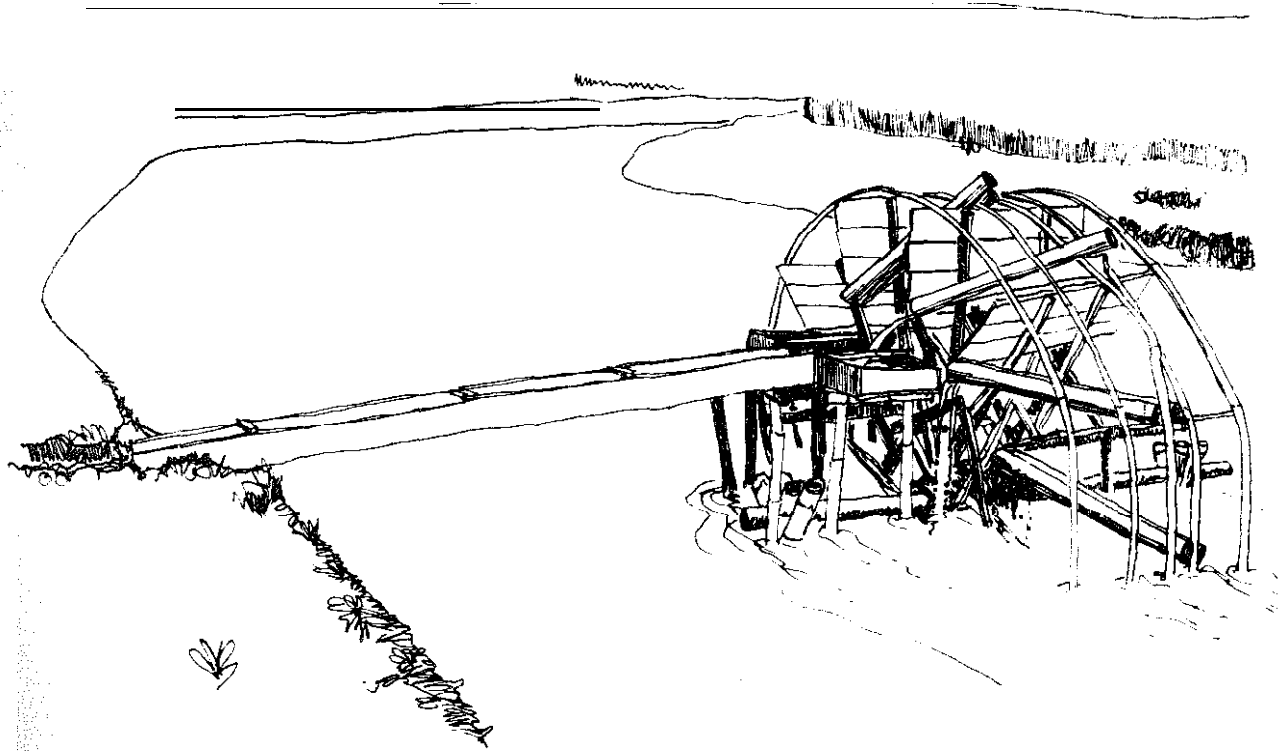

Oddly, the use of **waterwheels** for **lifting** irrigation water is only found in a few areas of Indonesia, notably West Sumatra and parts of West Java. However, there are rivers found **throughout** the nation **which** could be equipped **with such** wheels, in places where the **topo**graphy **has** made gravity-flow irrigation **sys-**tems difficult or impossible.

Indonesian water wheels are used to lift **water** 1 to 8 meters. The amount of water **lifted** **depends** on the height and the strength of the current in the river. Swift running rivers are best for these wheels. In good locations, the wheels can lift between 10 and 30 liters per minute (120 liters per minute are required to irrigate one hectare of wet rice paddy).

Usually, the wheels **are** used to irrigate one crop of rice after the rainy season. These wheels are built to last **only** one dry season, as the rain **alone** will provide sufficient irrigation water during the rainy season, and the high and swift running water in the rivers will carry away **but** the sturdiest waterwheels. Sometimes the

smaller wheels **can** be lifted out of the river at **the** beginning of the rainy season, to be **re-**paired and used again the following dry season. **The** very large waterwheels of West Sumatra, by contrast, are built to last many years, using many wooden components and lots of reinforcement. These large wheels are too expensive to be rebuilt annually.

These are undershot waterwheels. **The** current pushes the paddles attached to the rim of the wheel, forcing the wheel to turn. Each wheel has 12 to 24 rectangular paddles, made from boards or plaited bamboo. The wheel turns at a rate of about $\frac{1}{2}$ to 1% revolutions per minute.

As the wheel turns, slanted bamboo tubes dip into the stream and fill with water. Low-lift wheels have as many as two tubes for each paddle. Wheels with the highest lift have only one tube every other paddle. Each tube, holding about a liter of water, is slanted to retain the water until it has almost reached the top of the wheel. A wooden trough is positioned to the

side of the wheel to catch the water as it spills out of the bamboo tubes. A long **wooden** or bamboo trough or pipe carries the water to the river bank where it pours into a rice paddy or a ditch.

The wheels range from 2 to 10 meters in diameter. They are made primarily from bamboo, with some **wooden** parts. Some nails are used, but mostly they are lashed together with inner tube rubber, rattan or wire.

The West **Javanese** wheels have a wooden sleeve at the center, which rotates around a **fixed** axle. The axle is made of **2-inch** pipe, and

the sleeve is a long wooden box. The larger West **Sumatran** wheels have heavy wooden axles with iron bands on each end. These rotate in holes in hardwood blocks, which are on the top of two pilings that hold the wheel in place. The pilings are planted firmly in the riverbed, and reinforced with wire or bamboo anchored on the riverbank.

These wheels work well, supplying water to fields which otherwise could not be used for dry season rice cultivation. It is surprising that they are not found throughout Indonesia.

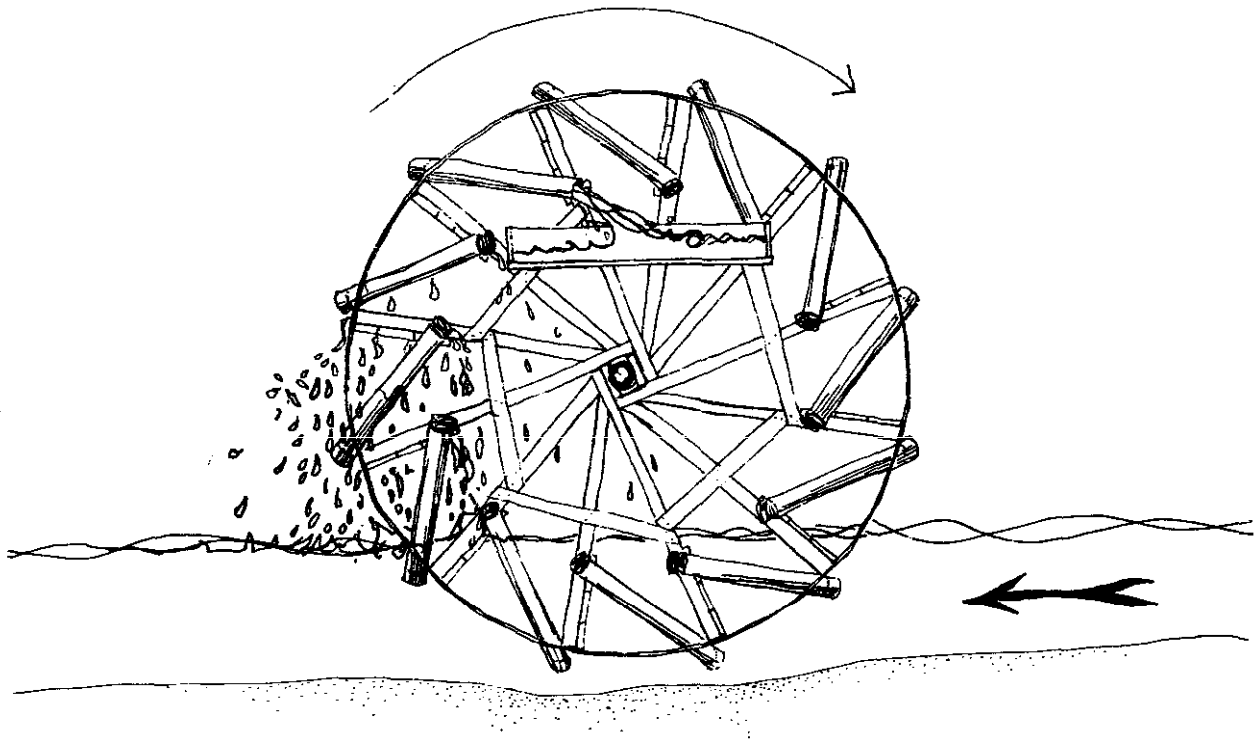

Fodder Trees/ Penghijauan untuk Makanan Ternak

In dry regions of densely populated Java, there is often not even sufficient grass to feed livestock. Deforestation and erosion have left much land barely able to support life. The inhabitants of these areas are urged to plant trees to help reverse the damage, but they are usually too busy trying to survive to bother planting anything with no immediate tangible benefits. Just searching for scraps of wood and trash for fuel is a full-time job for one or more family members.

In some areas of Java, villagers have learned to plant fast-growing varieties of trees to use for animal feed and fuel. They trim the branches from the shrub-like trees without cutting down or killing the trees. The branches are tied in bundles and fed to the livestock. After the animals **finish** chewing off the leaves, the sticks are dried in the sun and stored to use as cooking fuel. The most popular varieties that prevent erosion **while** providing fodder and fuel are fast-growing legumes like **Leucaena**, **Pete Cina**, **Turi**, and **Acacia**. Livestock also **like** the leaves of Jackfruit trees, though most people prefer to **let** these grow large and produce fruit.

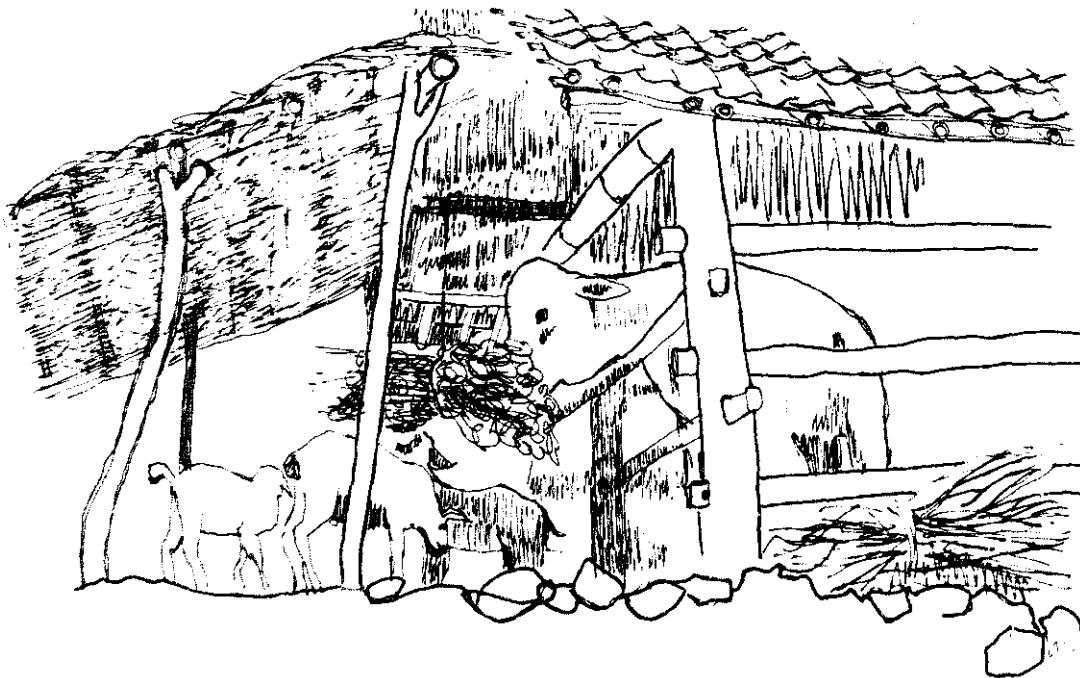

“Portable” Ducks/Pemiliharaan Itik

Duck raising can provide a substantial additional income for rural Indonesians. The eggs command a premium price and there are now hybrid varieties which lay as many as 270 eggs per bird per year. These profits become very thin, or even **turn to losses**, if the duck owner has to buy feed for his stock every day. Therefore, after rice fields are harvested, duck owners herd their flocks into the fields of stubble to gobble up the spilled grain. A man or boy herding 50 ducks along the side of Java’s highways using a bamboo pole with a ball of feathers tied to the end is a common and always entertaining sight. The ball of feathers was placed near the ducklings as they hatched from the shell. This **object** is thus imprinted in the ducklings’ memory and they follow it like a mother.

But ducks walk slowly, sometimes taking most of a day to walk to and from a rice paddy located far away. Also, the more energy they expend walking, the less there remains for the production of eggs. So, often during harvest season, the duck owner will take his ducks to the area where fields are being harvested and take along a short, plaited bamboo fence. The fence can be **rolled** up into small bundles for storage and transport. Ten or 15 meters of fence formed into a circle and supported with a few light sticks make a fine pen where the ducks can sleep and lay their eggs. Sometimes straw is spread for the birds’ comfort and to encourage them to lay, but most ducks will lay eggs on open ground.

If the destination is so far away that walking the ducks becomes impractical, the ducks are loaded into large open-weave bamboo boxes like the ones stacked next to the portable duck pen below. These boxes are dangled from the back of small vehicles or buses en route to their scavenging grounds.

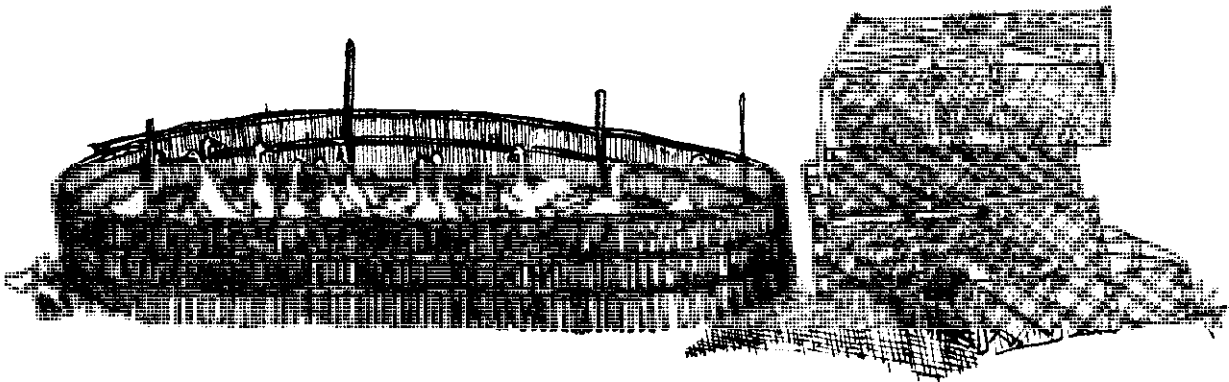

Fishing and Aquaculture/ Perikanan

Fish play a vital role in supplying the Indonesian population with protein. Indonesia is an island nation, blessed with more coastal fisheries than any other nation on earth. But in addition to these rich offshore waters, Indonesian villagers harvest thousands of tons of fish from fresh and salt water cultivated ponds.

Fishpond technology was probably introduced into Indonesia by Chinese immigrants before the 12th century A.D. The Chinese had been raising fish in their own country for centuries, already reaching a high level of sophistication. The **first** written record of fishponds in Java appear in the *Kutara Menawa* statutes written in the early 15th century. This document mentions both salt and fresh water ponds, **setting punishments for the theft of fish**.

Cultivating fish in partitioned saltwater marshes had its origins in Java during the Mojopahit era (14th through 15th centuries AD). Political prisoners **confined** to isolated areas on the northern coast of Java produced salt and guarded **lighthouses**. These prisoners **built** earthen **bunds surrounding** shallow sections of the marshes. At high tide, they would open gates to allow seawater in, closing them again to keep water and fish inside until they could trap them. **This** was not fish farming but rather a crude system for trapping sea fish, but it is speculated that they eventually developed techniques **for** raising large amounts of fish and shrimp in, their *tambak*. Java's north coast is still Indonesia's largest *tambak* area; in other

areas, this skill probably came as a result of trading in Java.

Freshwater aquaculture has also become a traditional skill in many parts of Indonesia. It is most common in West Java, where it too has reached a high level of sophistication. In some Sundanese villages, every house has a fishpond in the yard with the characteristic latrine perched on stilts above the water. Many of these people also raise fish in the rice paddies as a second crop.

The techniques **for** raising fish in rice paddies appeared relatively recently. The first written records of this practice are Dutch reports from the mid-19th century. At that time, rice was planted only once each year and people began using the paddies as fishponds after the rice harvests. The colonial government began encouraging the practice in 1894. Two decades of intensive irrigation network development in Java during this period contributed to the spread of this practice. During the Japanese occupation, people in West Java began to raise fish in paddies along with the rice crop.

The most recent development in Indonesian aquaculture is the appearance during the last two decades of fast water ponds. **Large** numbers of **fish** can be grown in small ponds if the water flow is rapid enough to assure a plentiful supply of oxygen. However, these fish must be given additional food, as the algae and microorganism content of fast-moving water cannot support the high fish population. The spread of this practice coincides with rapid urbanization in Java: urban and suburban residents do not have sufficient space for the **construction** of traditional ponds.

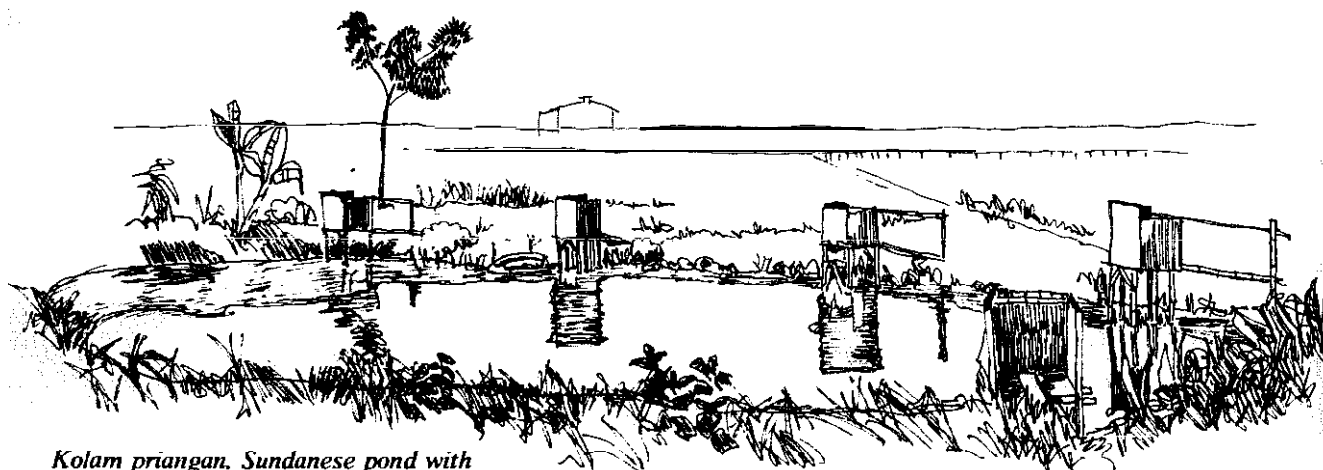

Kolam priangan. Sundanese pond with latrines for feeding the fish.

Fish Farming/Kolam Ikan

West Javanese fish farmers are some of the most productive and successful in the world. Most of the techniques that they employ are quite simple, requiring minimal capital investment and only simple knowledge and skills. However, production levels are quite high, contributing a significant amount of protein to the average diet.

Most fish farming is done in small fresh water ponds in the owners' yards. Some fish are also raised in rice paddies. Coastal ponds for *bandeng* milkfish are gaining popularity in areas where river deltas meet the sea, where there is sufficient tidal activity, and where there is a source of *bandeng* fry called *nerer*.

Areas suitable for pond construction must have a sufficient supply of running water, along with sandy, silt, or heavy loam soil with a high organic content and pH of 8.0 to 9.5. Sandy soil loses too much water to absorption, but can sometimes successfully be lined with a layer of clay mixed with humus. Clay soils must be mixed with large amounts of sand in order to be suitable for fish ponds. The high organic content of soils suitable for pond construction serves two functions: it helps seal the ponds and also provides nutrients for the growth of micro-flora and fauna which provide a portion of the needed food for the fish.

Ponds are between 75 cm and 1.2 meters deep. Hatchery ponds can be quite small-10 to 15 square meters. Ponds for raising fish should be 20 to 50 square meters. The surface to volume ratio should be between .8 and 1.2 to assure sufficient absorption of oxygen by the water. Channels are dug either around the edge of the pond or in a cross or X dividing the pond into quarters, providing a place for the fish to gather as the pond is emptied for harvest. Long rectangles are the best shape for fish ponds, so that the water may enter at one end and drain from the opposite one, assuring a more complete exchange of water in the pond. Basket-like screens are placed over inlet and outlet pipes to prevent fish from entering or leaving.

Fish farmers are unable to provide specific figures for proper rate of exchange of water, but all agree that the higher the flow the better. A once daily exchange of pond water is good.

Sufficiently rapid exchange of pond water helps assure a sufficient oxygen content. If possible, the water entering the pond should drop and splash into the pond, further assisting aeration. In addition to these aeration techniques, some fish farmers are fencing off small portions of their ponds for growing water plants such as water hyacinth or *kangkung*. In addition to providing some oxygen, water hyacinth has the extra benefit of being able to absorb pollutants such as pesticides and heavy metal toxins.

Before stocking, the ponds are dried out for a few days. Fish farmers claim that this is to "warm up" the soil; it probably has the main function of ridding the mud of parasites and disease organisms. In fact, a recent epidemic of a new and deadly virus infection in fish was eliminated when a long dry season left nearly all of the West Java ponds dry for a month or more. Fish are raised in three month stretches, after which the ponds are emptied, the fish moved or sold, and the ponds dried out, refilled and restocked.

Most fish farmers buy fry or fingerlings from farmers who raise them specially. The breeding stock are kept in separate ponds. They are bred and then separated again. Most varieties lay their eggs on special racks of *ijuk* fiber called *kabakon*. The *kabakon* are then moved

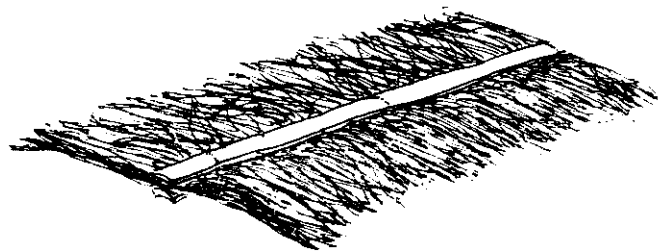

into shallow hatchery ponds. After the fish hatch they are kept in these ponds for about a week until they are strong enough to be caught and sold.

Fish farmers can buy these fry for stocking their ponds, or they can stock their ponds with fingerlings which have been raised in other ponds for three to six months. Some varieties reach 6 to 10 cm in length after only three months-big enough to eat. Most people prefer to harvest larger fish which have been raised 6, 9 or 12 months. The most common varieties of fish raised in Indonesia are carp or goldfish, *mujair*, *gurami*, *tumbuk* and *bandeng*. Cattish

and eels are gaining popularity, **too**, but require different methods. Cattish ponds must have thick banks so the fish can tunnel and build nests, and eels are raised in drums or small cement-lined ponds **filled with soft** mud.

Ponds are stocked with 75 to 300 grams of fish per cubic meter of water. Properly maintained **fish** will gain weight at a rate of 25 to 35% per month. The fish are given approximately **2-3%** of their weight in food each day. The most common food is a mixture of rice **polishings**, manure and urea fertilizer, which is placed in a finely woven basket or gunny sack and suspended in the water so the fish can gather around and eat the food as it filters out into the pond. Blood **and** bone meal are also sometimes used if available.

There are also several simple low- or no-cost methods of supplementing the diet of the **fish**. Dishes and cooking utensils are

washed in water flowing into the pond, thereby giving **food** scraps to the fish. Many people defecate and urinate into their ponds, although this is not recommended for sanitation reasons. Two other methods are regaining popularity. Fast growing leguminous trees are being planted around the banks of the ponds, so that their leaves drop into the ponds and encourage the growth of moss and algae. Livestock is being raised in pens constructed over the ponds so that their spilled food and manure drop into the water, either to be directly consumed by the fish or to fertilize the pond's flora. The latter **two** innovations have considerably improved the economics of fish farming by reducing the amount of additional feed needed, and also utilizing pond space for the production of firewood, animal feed, and livestock products such as eggs, chickens, rabbits and goats.

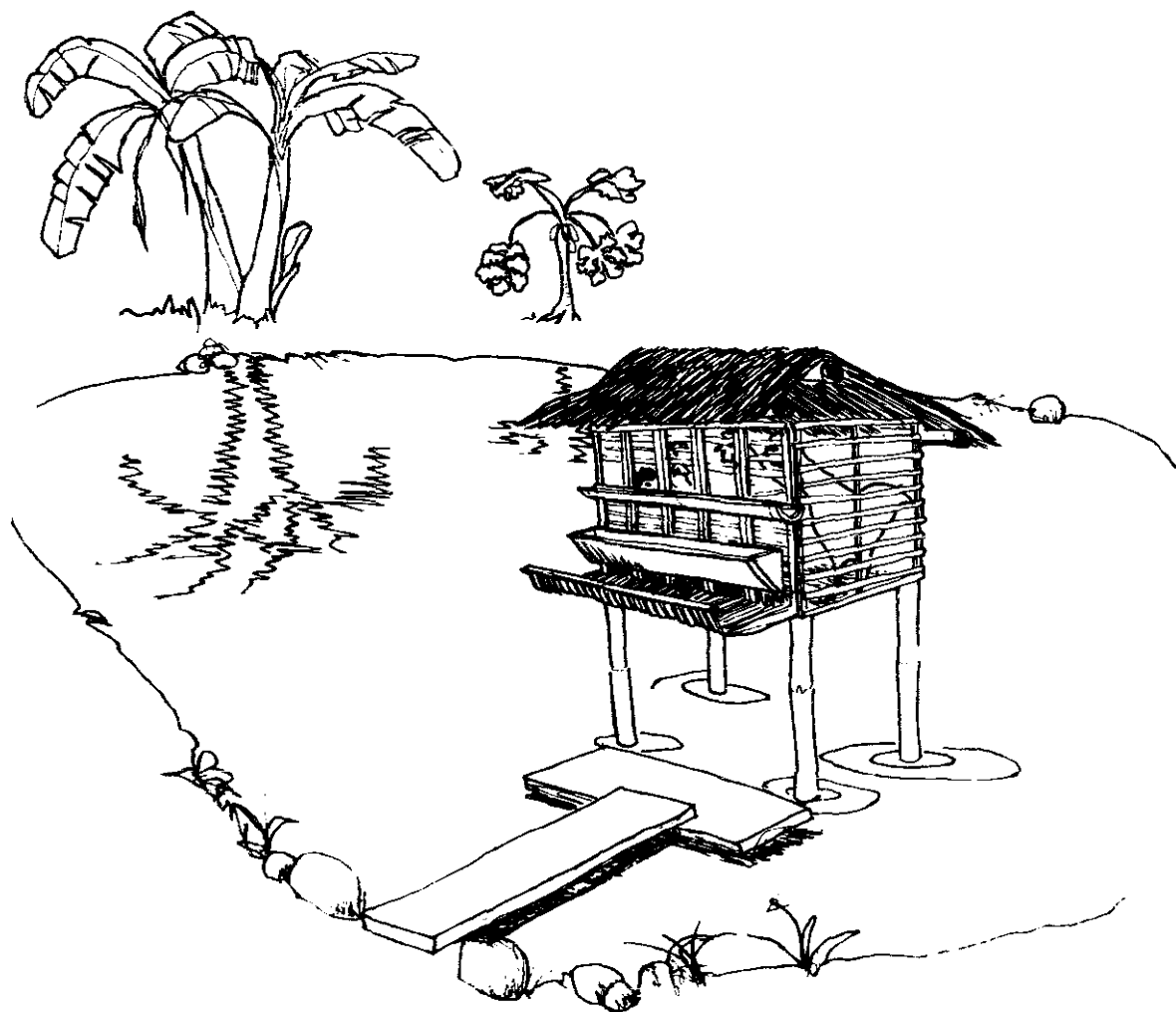

Besides diseases and parasites, major pests endangering fish farms are birds, snakes and thieves. Losses due to snakes and theft are reduced by locating the ponds near houses. Where birds are a problem, farmers often stretch a grid of strong fishing line at 60 cm intervals over the top of the pond, about 40 cm above the surface. After a few crash landings attempting to **dive for fish**, the birds are usually inclined to go elsewhere to look for their meal.

A few fish for daily consumption can be caught with lines and hooks, lift nets such as *anco* or *pecak*, or traps such as *bubu*. When it is time to harvest, the ponds are emptied and the fish scooped up from **the channels** in the base of the pond. Fish are **transported** alive in plastic bags part filled with water and blown up with oxygen if it is available, or in traditional tightly woven baskets sealed with pitch or tar. The water is exchanged several **times in a** day's travel.

Some varieties of **fish** such as carp and *gurami* can be raised **along with** rice in specially prepared paddies. The banks are raised and strengthened, and a 50 cm wide by 30 cm deep channel is dug around the paddy and in a cross or X dividing the paddy into quarters. A 50 cm deep, one by one meter hole is dug in the center

of the paddy. Because of the space required for these **channels**, the total amount of rice which can be grown in the paddy is slightly lowered, but this loss is more than offset by the additional fish crop.

Eight weeks are available during the rice growing season for **fish** raising; between the second **weeding** when the water level is raised from three to **five** cm and the time that the paddy must be dried for the harvest. 10 to 14 cm **fingerlings** can grow to edible 15 to 18 cm **fish** during that period, with weight gains of about 30 percent.

After weeding, the paddy must be dried for **two** or three days, then tilled with water until it is at least **five** cm deep. As the rice grows, the water level is raised to 10 to 15 cm until the grains begin to ripen, at which point the water is slowly drained from the paddy, giving the fish time to reach the pond in the center of the paddy where they can be harvested.

1000 to 1500 fish per hectare can be raised in this manner. No additional feed is required beyond the fertilizer used on the rice and the algae and insects growing in the paddy. It is important not to overspray insecticides on paddy used for **fish** farming, as this can kill the **fish**.

Raising Fish in Cages/Keramba

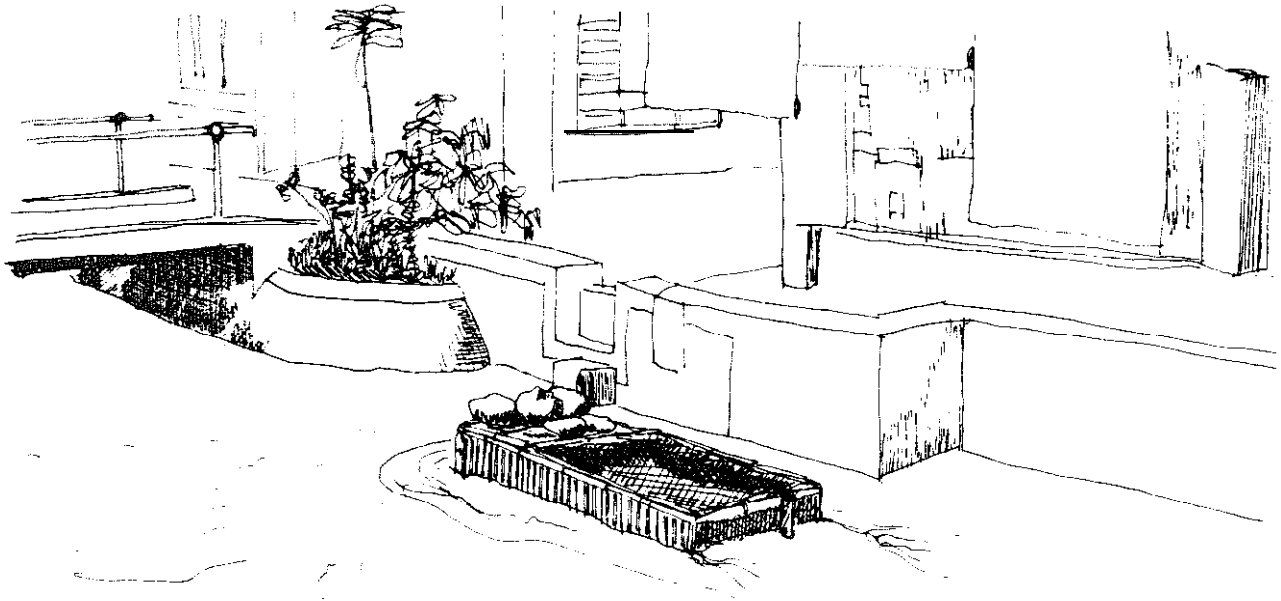

The technique of raising fish in cages (*keramba*) placed in rivers and irrigation canals is an ancient practice in some parts of Southeast Asia. This practice first appeared in Indonesia during the Japanese occupation of World War II. The Japanese army probably brought this technique from Vietnam, where huge floating fish farms have been operated in the Mekong river for centuries. The hungry Indonesian population began crowding into the cities during the war, and more intensive forms of agriculture, livestock and fish management had to be used to feed the people. After the war the urbanization of Java continued, and the use of *keramba* for fish cultivation in urban and suburban areas became more commonplace. Soon the disadvantages of this practice became apparent. *Keramba* trap floating garbage, and if untended soon block the flow of rivers and canals, causing flooding and accelerating erosion of the banks.

Eventually the Irrigation Authority of Kabupaten Cianjur outlawed *keramba* and ordered all of them in that area to be destroyed. Some other local governments followed suit. Finally the government and the farmers compromised: the government set rules on which types of waterways could and could not be used for *keramba*, and farmers began building

slightly modified *keramba* that were less likely to catch floating garbage and block the flow. The farmers began placing the *keramba* entirely under the surface of the flowing water; whether this was started to avoid trapping floating garbage or to hide the *keramba* from the authorities is not known. The government banned the placement of *keramba* in "technical waterways," meaning canals built by the gov-

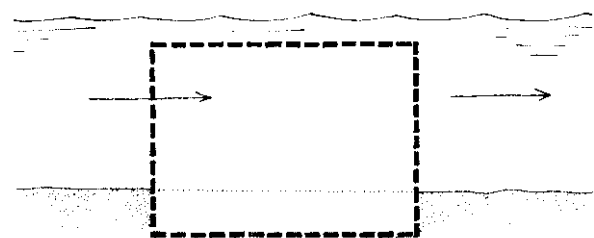
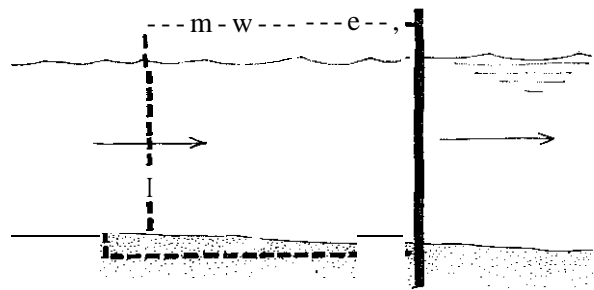

ernment, as opposed to **natural** rivers or secondary and tertiary canals built by the villagers themselves. The Directorate of Fisheries also recommends that the banks of canals or streams used for **keramba** extend at least one meter above the water level at normal flow and that the streambed of the site selected be of sand or gravel.

In order to fit their **keramba** below the water level and still have structures of sufficient size, the farmers began to dig holes 20 or 30 cm into the streambed for the placement of their cages. **Keramba** typically measure 2 to 3 meters long, 1 to 2 meters wide, and 50 to 100 cm deep. They are made of bamboo slats nailed to a wooden frame, with a removable door forming part of the roof. The 4 cm wide bamboo slats are nailed vertically onto the frame with 1 cm spaces between them. In small streams or canals **keramba** are often built across the entire width, while in larger waterways they are placed near one of the banks. The water in the streams or canals should move fast enough to assure a plentiful supply of oxygen to the fish.

Keramba are stocked with 2½ kg of 10 to 20 cm long carp fingerlings per cubic meter of **keramba** volume. The fingerlings are then fattened for 3-5 months. The mature fish are harvested a few at a time. The largest fish are scooped out with nets as they are needed, and the smaller ones are left to grow larger.

In murky green or bluish water, the algae content is usually sufficient and the fish need no additional food. But in clearer water, they are fed daily. One kg dry weight of fine rice poishings per 100 kg of fish in the cage is placed inside a woven plastic gunny sack, which is then tied shut and placed inside the **keramba** each morning. The fish crowd around the sack, bumping and sucking the food through the coarsely woven sack.

Even if it is not necessary to feed the fish daily, it is general practice for the owner to check the **keramba** daily to assure that no trash has become lodged in it. Every two weeks the owner cleans the algae and aquatic weeds from the bamboo slats to assure that the water can flow through the **keramba easily**.

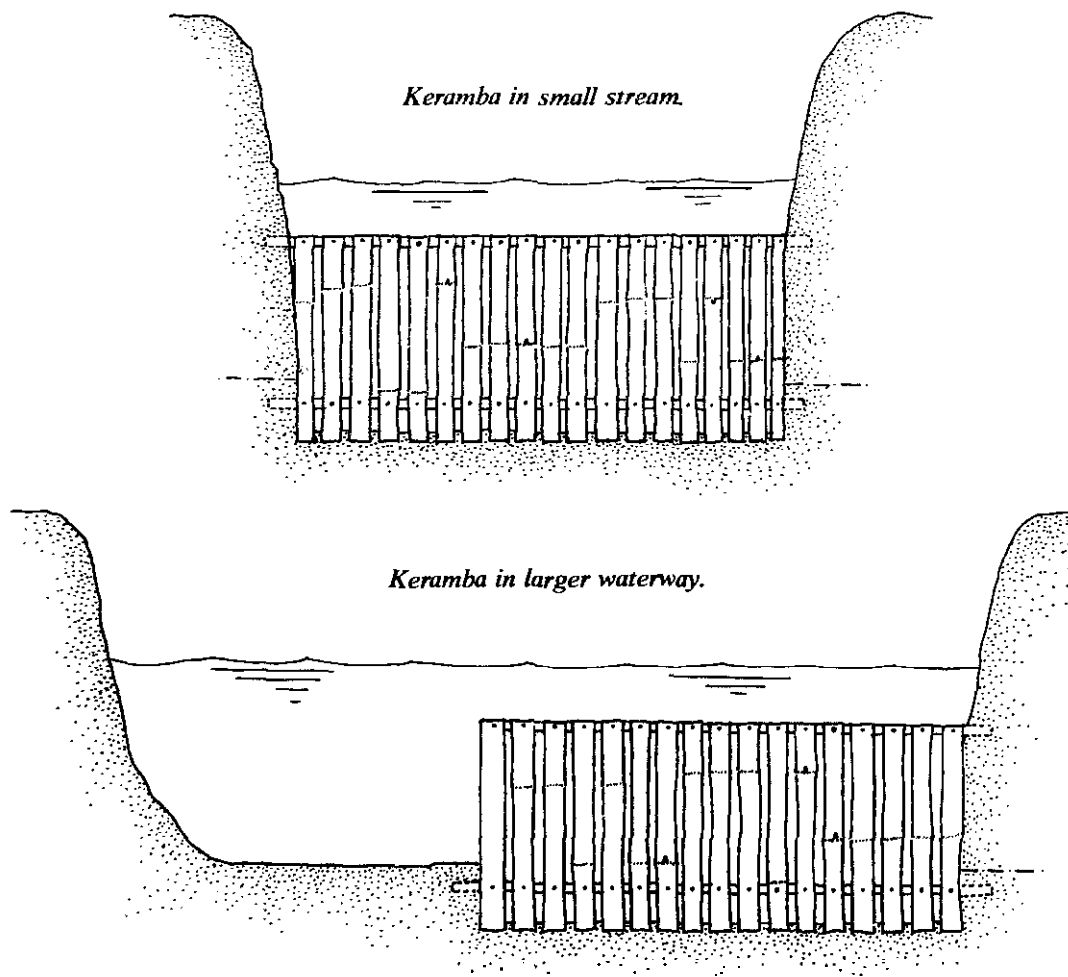

Fish Trap/Bubu

Passive fish traps called *bubu* or *wuwu*, relying on bait or tidal river flow, are used in many parts of Indonesia. They are found in many different shapes and sizes, but all have one feature in common: a set of spines arranged into a cone shape that points into the trap. Once the fish or shrimp enter through the mouth of the trap, they cannot swim out again. To remove the trapped fish, there is an opening in the end or the side of the *bubu* which is normally closed when the trap is set.

Most *bubu* are made of bamboo strips plaited with rattan or cord. Some are also made of rattan or from the needle-like sticks found in the *ijuk* fiber from the *Aren* palm. They range in size from about 30 to 200 cm long. The most common shape resembles a wide-bottomed Coke bottle. Because submerging bamboo, rattan or *ijuk* in water helps to preserve these materials, *bubu* last a long time. A carefully maintained *bubu* can be used for up to two years.



Placing a *bubu* in a swamp. The earthen bund directs the flow of water through the trap.

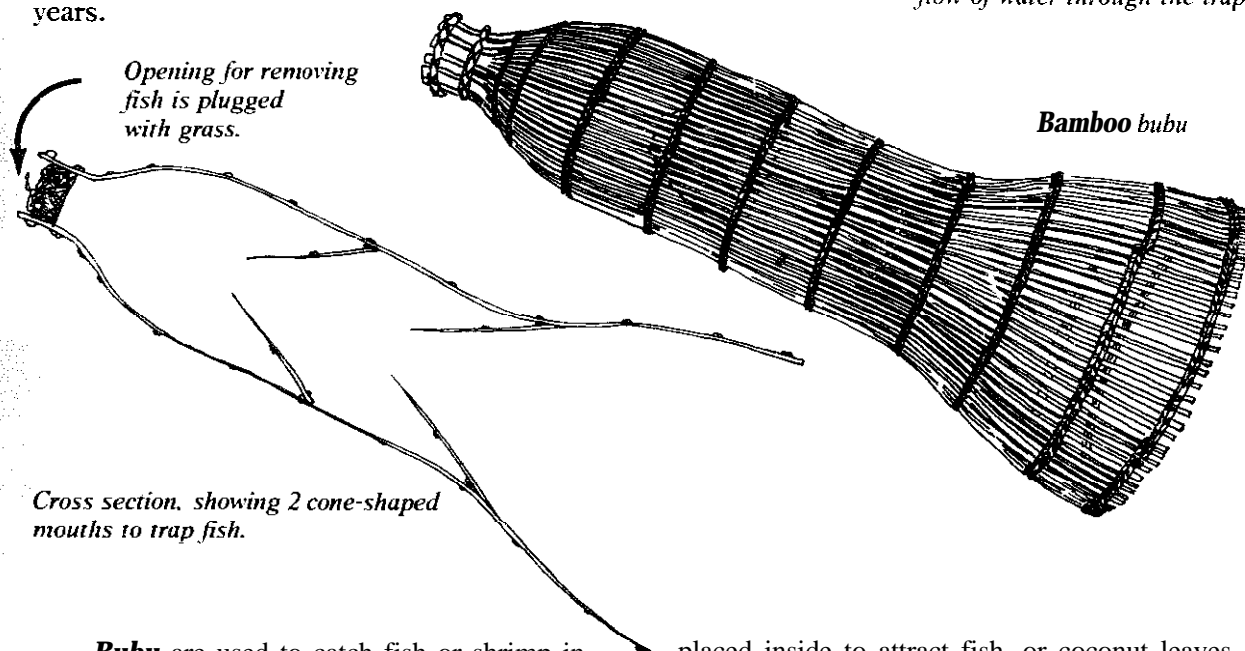

Cross section, showing 2 cone-shaped mouths to trap fish.

Bubu are used to catch fish or shrimp in many different types of shallow water bodies. If there is a current, such as in rivers or tidal swamps, the traps are placed facing into the flow, often with an earth bund or other barrier to direct the water and fish into them. In still water either bait or the opportunity for shelter is used to attract the fish. The *bubu* are either weighted with rocks or secured to stakes or lines. Small bits of fish, shrimp or crab meat are

placed inside to attract fish, or coconut leaves are arranged around the traps to provide dark hiding places for shrimp or small fish.

Depending upon the habits of the fish being sought, *bubu* are either placed in the afternoon and collected the following morning, or placed before dawn and collected in the afternoon. Sometimes they are left in place all the time, with the owner visiting each trap once daily to remove the fish.

Fish Trap/Tanggok

Another type of tool used for catching fish in shallow swamps or in fallow or recently harvested rice fields is the **tanggok**. This is a cone-shaped bamboo basket, open at the base, with a smaller opening at the top. It is stabbed repeatedly into the shallow water and mud. When a fish is trapped in the **tanggok**, it usually becomes frightened and splashes around the confined space. The fisherman must react quickly to avoid releasing the fish by lifting the **tanggok**. The fish is then pulled out through the hole in the top. Usually several people, each with their own **tanggok**, form a line and walk across the swamp or paddy together, decreasing the chance that the fish can swim past them and escape.

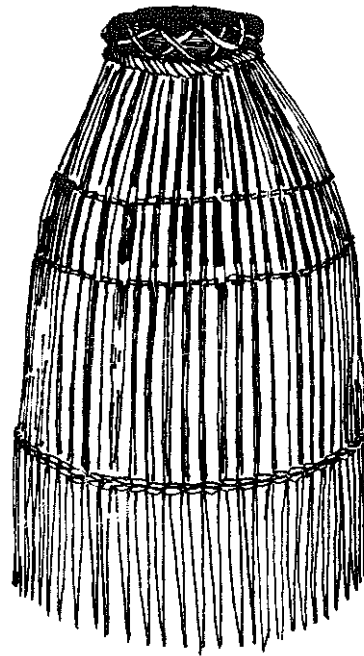

Large Lift Net/Anco

Large square-shaped nets called **anco** are used to harvest fish from cultivated ponds and natural waterways. The nets consist of 4 parts:

1. A square-shaped net, woven from strong cotton, flax, nylon or other cord. The nets measure from 2 by 2 meters up to 4 by 4 meters. Often the net has a tightly woven patch in its center, with 1 cm holes, while the outer areas have 2 or 3 cm holes.

2. Two pieces of thin bamboo, tied in the

center, with each end tied to a corner of the net, forming a bowed cross above the net.

3. A sturdy bamboo handle connected to the center of the crossed bamboos, long enough for the operator to drop the net into the water away

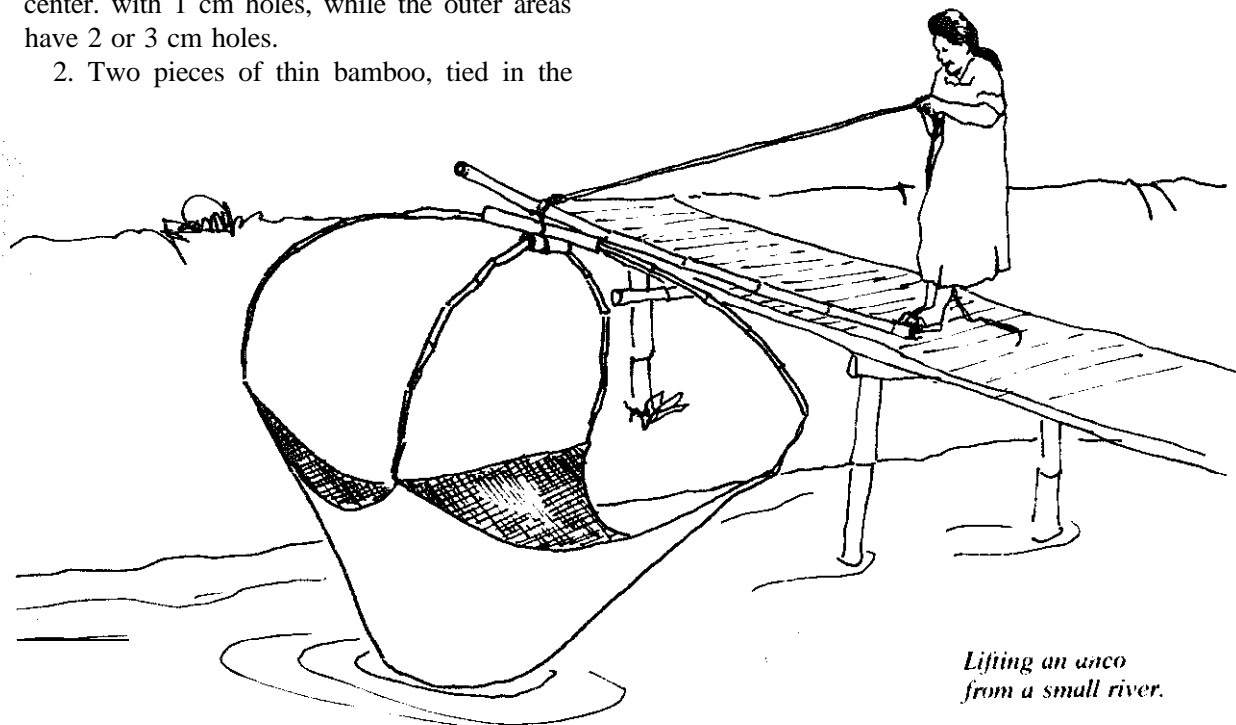

Lifting an anco from a small river.

from the bank or platform.

4. A length of rope tied to the end of the bamboo handle where it meets the crossed bamboos. This allows the operator to lift the heavy net from the water.

Anco are set in place by operators standing on banks or bridges, or sitting in a special tower built above the water. **Anco** use no bait. Often the operator simply waits until enough **fish** have wandered into the water above the net. Fresh water flowing into a **tambak** also attracts fish. Or several people can wade into the water, slapping and **splashing with** palm leaves to herd the fish into the area above the net.

The **anco** is lifted by fixing the end of the handle into a notch in the platform or standing on it, and pulling on the rope until the net is free of the water. The fish are then collected and the net set in place again in the water.

Small Lift Net/Pecak

Small lift nets, similar in form and function to **anco** are called **pecak**. The 1 X 1 to 1.5 X 1.5 meter **pecak nets** are much more finely woven, sometimes using cloth from flour or rice sacks. **Because** the nets are small and light, a bamboo handle alone is sufficient to lift them from the water; no rope is needed.

Pecak are used to catch shrimp and fingerlings in shallow water. Often bits of bait such as dried shrimp or rice **polishing** paste are used to **attract** the fish. One operator usually uses

several **pecak** at a time, wading a few meters into the shallow water and setting the **pecak on** the bottom. The bait is tossed **into** the water over the net. The operator then moves on to tend the other **pecak**, returning every few minutes to lift the **pecak** and pick out the few tiny shrimp or **fish**.

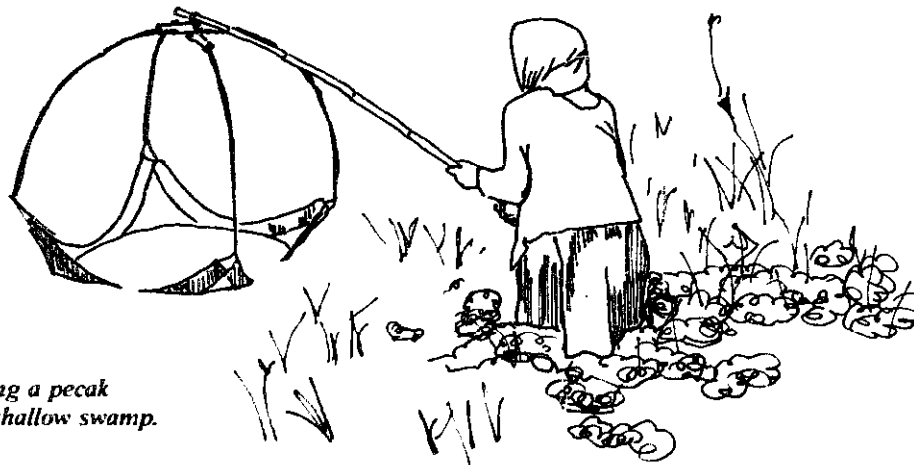

*Placing a pecak
in a shallow swamp.*

Toss Net/Jala



Tossing the jala.

Round toss nets called *jala* are used throughout Indonesia to catch **fish** in shallow waters such as swamps and rivers. *Jala* have 3 parts:

1. A round net of knotted cotton, flax or nylon cord. The nylon nets last longer, but are slippery and do not hold the fish as well as the natural fibers. *Jala* have a diameter of 2 to 3 meters.

2. Lead washers are tied all around the edge

of the *jala* to cause it to spread when tossed and to sink quickly and evenly.

3. A rope tied to the center of the net is used to pull the net back out of the water.

The *jala* is tossed with a twisting motion so that it spreads out flat before hitting the water. It sinks to the bottom and with luck it traps a few fish. As it is pulled out by the rope, the edges draw together, entangling the **fish** inside.

Coastal Fishing/ Perikanan Daerah Pantai

As a nation of islands, Indonesia has thousands of kilometers of coastline and vast areas of shallow coastal seas. Coastal fishing provides Indonesia's expanding population with a major source of protein. Because the waters are shallow and there are hundreds of different varieties of fish found there, these seas are more suited to small-scale fishing techniques than those of large commercial outfits.

There are almost as many different fishing technologies as there are different population groups living in Indonesia's coasts, but they can be divided into a few main groups: traps, fixed nets placed across tides or currents or

channels where **fish** migrate, drag and push nets, lift nets, and miscellaneous techniques including the use of hooks, spears, bow and arrow, harpoons, forks, snares, poison, explosives, electric shock, etc.

Most traps employed are either cages or fenced-in areas with cone- or arrow-shaped mouths which allow the fish to enter the trap and then prevent their escape, like the small **bubu** explained in the previous section. In fact, many of these traps are called **bubu**. The shape and size of offshore **bubu** differs from the **bubu** used for inland waterways. They are usually large cylindrical or rectangular cages made of bamboo or rattan, with cone-shaped mouths at

one, two or more places. A few use bait, but most simply depend on the natural propensity of fish to hide in protected places.

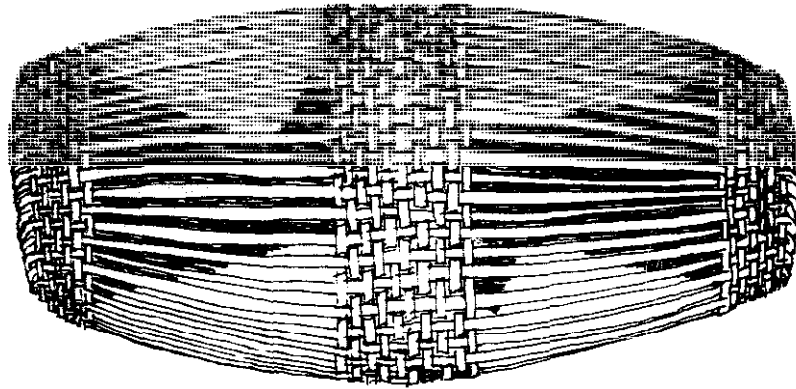

Bubu

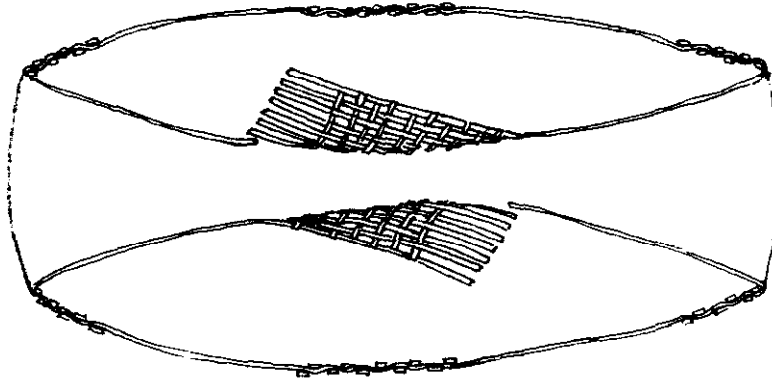

Another larger type of trap is called the *sero*. This is a fenced-in area with either one, or more commonly, a series of heart-shaped pens which entrap the fish. Each pen in the series opens into a smaller pen, and finally into a small crib where the fish can be lifted out. Often a fence, or "tongue" of stakes projects outward from the mouth of the *sero*. Although

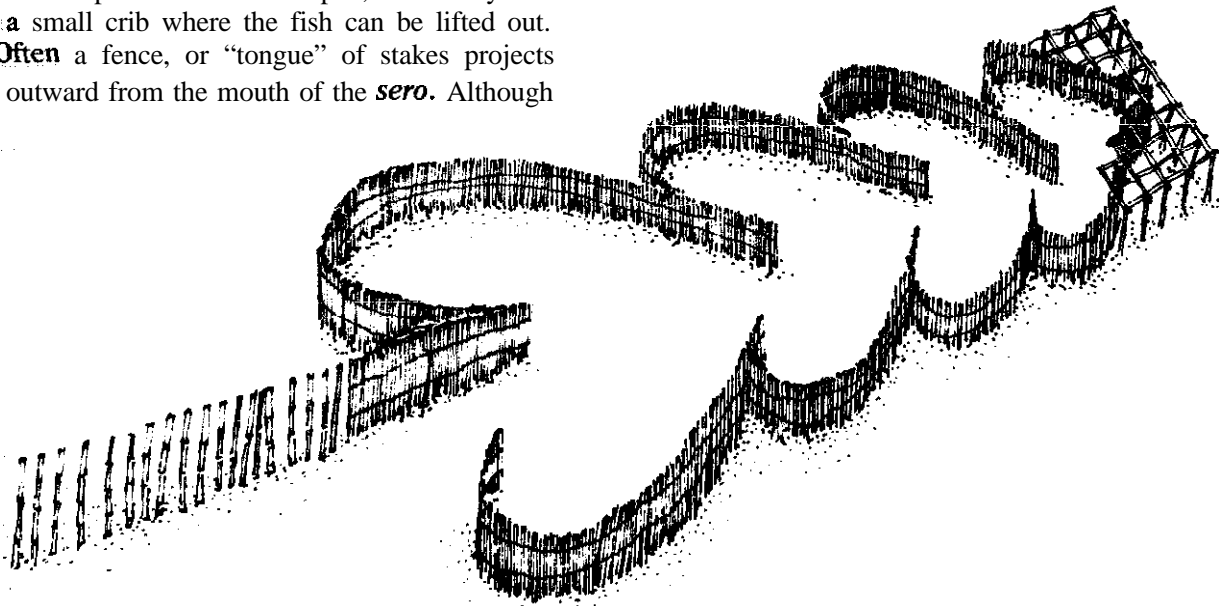

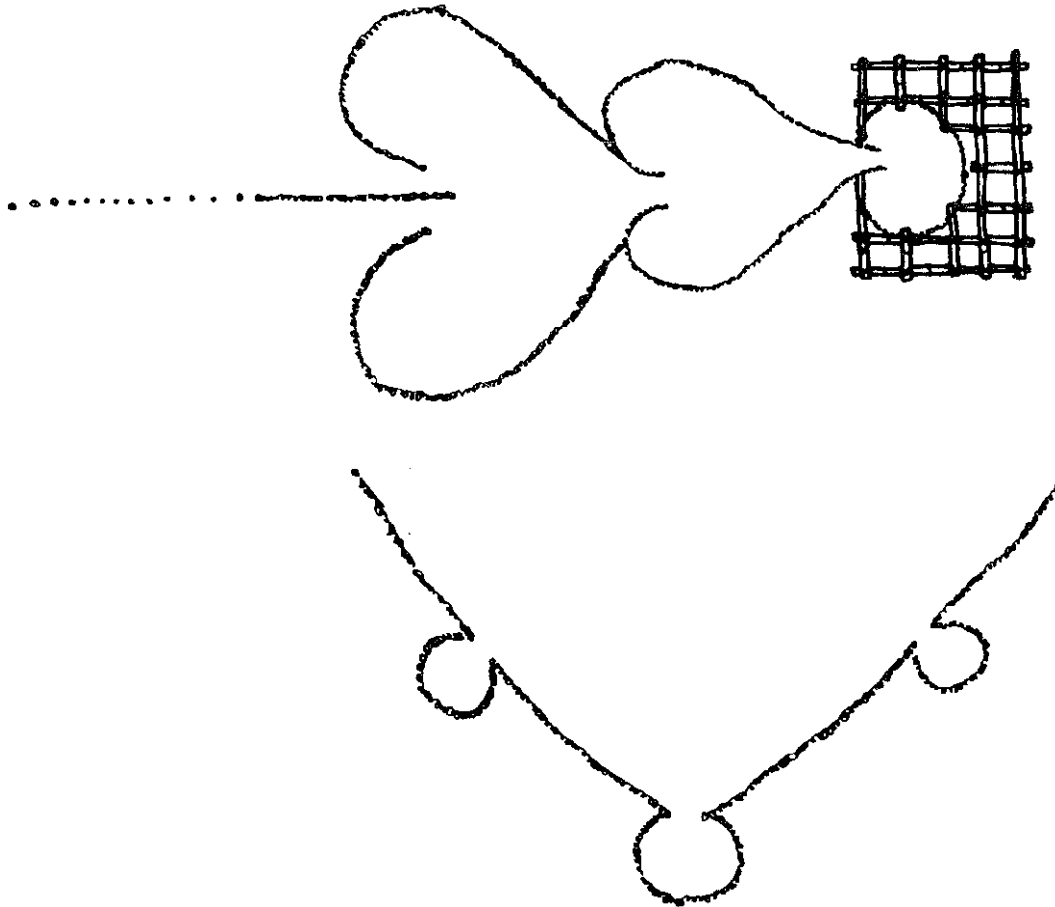

these stakes are placed far enough apart that fish can swim through, the fish usually tend to follow the line of the fence into the trap. *Sero* are usually made of tightly bound bamboo splits, or of woven net held in place by stakes driven into the sea bed. *Sero* are used in water up to two or three meters in depth. Once or twice a day the *sero's* crib is emptied of its fish using scoop nets or lift nets such as *pecak*. A platform is built around or over the crib to facilitate this task.

Fixed nets are most commonly employed adjacent to beaches or at river mouths. The most ideal situation for placement of these nets is where waves break at an angle against the beach, so that the nets do not block the incoming waves, but still can catch the fish in the receding wash. They are placed so that the two ends of the net are above the water line when the tide is out. When the tide recedes, the fishermen can collect all of the entrapped fish with scoop nets, push nets, or even by hand.

The nets are usually made of knotted sisal or nylon netting, bound bamboo splits, or even stacked coral or stones.



Drag and push nets range in size from small triangular-mouth cone-shaped nets or butterfly nets pushed through shallow water to **large *pukat harimau*** which are pulled by motorized fishing boats. The Directorate of Fisheries has begun placing limits on the number of ***pukat harimau*** which can be used for fear that certain areas are being overfished.

Push nets and **skimming** nets are most commonly pushed by a fisherman walking through shallow water, but occasionally larger nets are held by a fisherman standing in the bow of a small boat which is sailed or rowed by other crewmen.

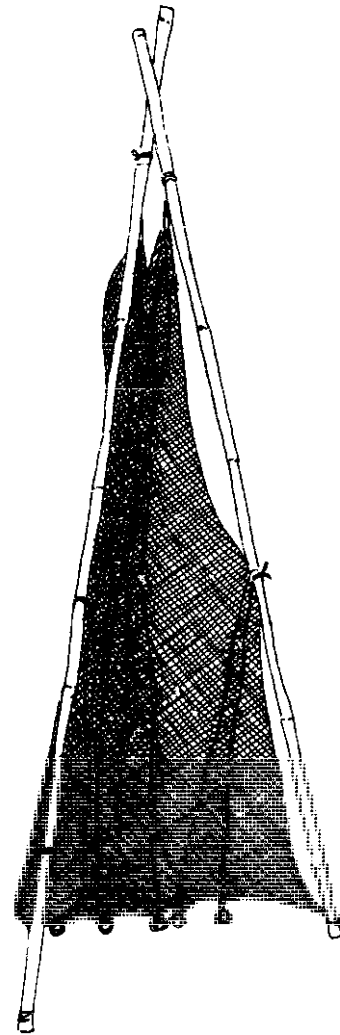
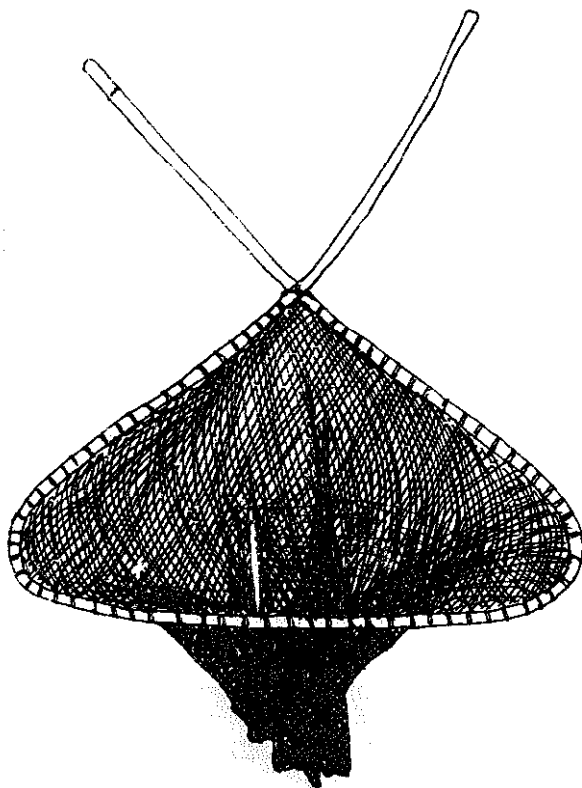

There are two main types of large lift nets: large mouth cone-shaped **filter** nets held under platforms which are built on **stakes** or floated on pontoons, or large rectangular flat nets which are drawn up when a large number of **fish** have **congregated** over them.

The cone-shaped filter nets face into tides or currents or paths of fish migration. Often they employ a fence or tongue of stakes or even heart-shaped trap nets like **sero** to direct the fish into the nets. When enough fish have entered the net it is lifted out with the ropes and

emptied, often several times each day. Like all of the other devices described above, these nets, called **jermal, togo** or **tadah**, are used in shallow water, up to about three meters in depth. Smaller versions of these nets can be moved about and set in place with small boats when large schools of fish are discovered in certain areas.

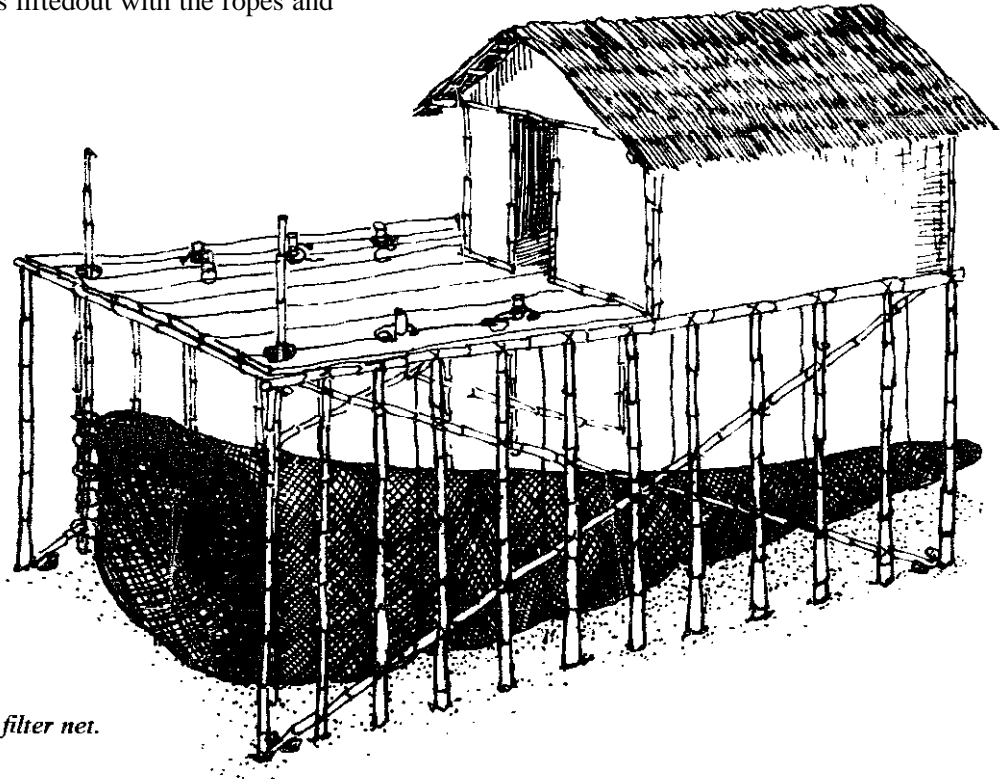

Cone-shaped filter net.

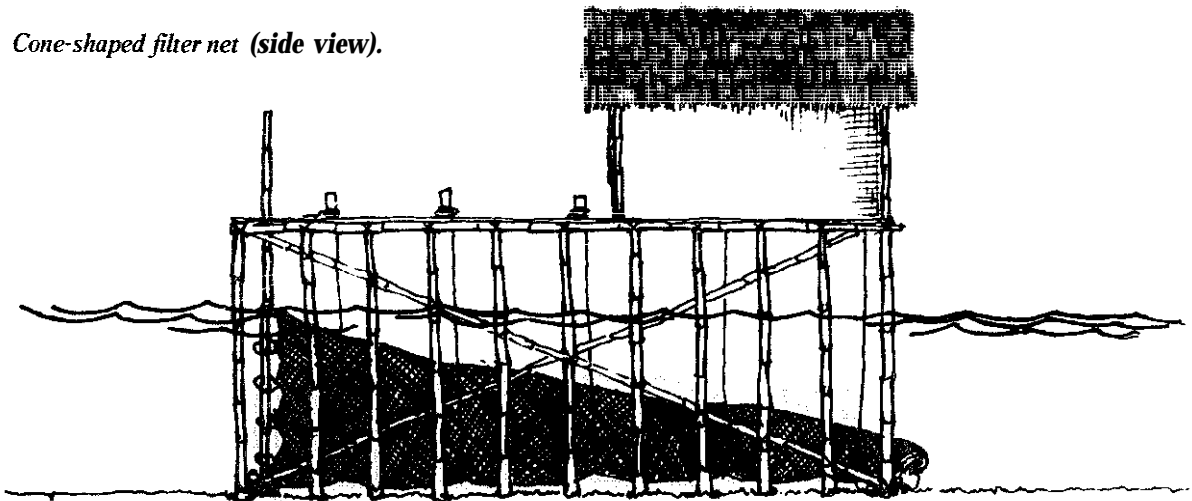

Cone-shaped filter net (side view).

Rectangular Bat lift nets are called *bagan*. They are usually held in place under platforms built on poles planted in the sea bed, but there are also floating *bagan* which can be moved from place to place. Some *bagan* employ *sero*-like fences to direct fish into the net, but more often they draw the fish to the net using bright kerosene lamps at night.

All of the devices described above are quite simple and primitive, but they are well-suited for Indonesia's coastal waters. Large amounts of fish protein are provided to Indonesia's large population, but the seas are not seriously depleted of fish.

Rectangular lift net.

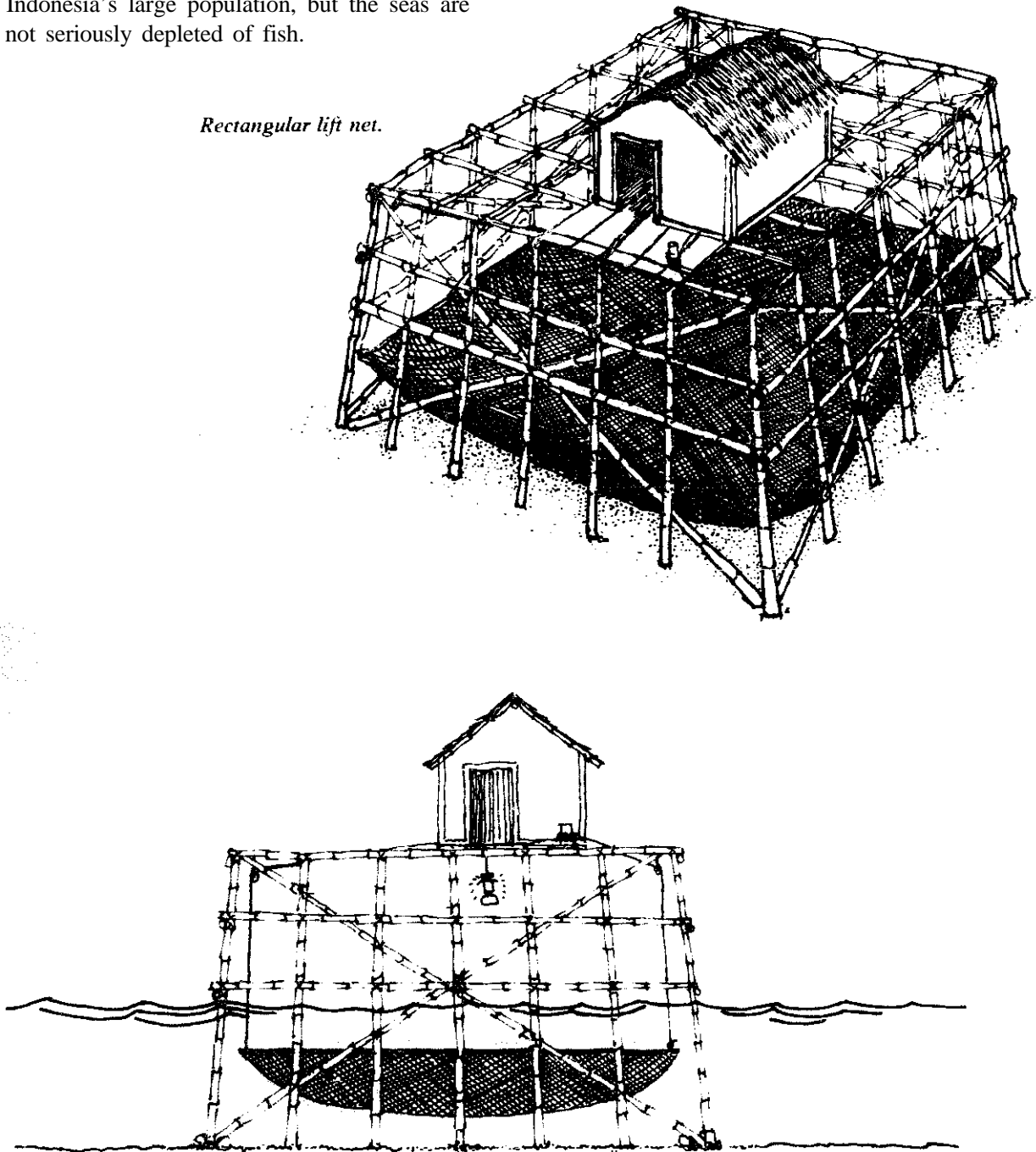

Fish Processing/Pengolahan Ikan

A large proportion of Indonesia's fish catch must be preserved by salting, because there are still very few refrigeration and canning facilities in the country. In fact some 75% of the total fish catch, and 90% of the fish caught outside of Java, is treated with salt. Much of this salted fish comes to Java by ship. There have been a few canning factories built, but their product is much more expensive than fish treated with traditional methods. A few attempts have been made to introduce smoking as a method of fish preservation, but it has not yet become popular.

The most common methods of fish preservation are dry salting, salting followed by fermentation to make *ikan peda*, and salting followed by cooking to make *ikan pindang*. Dry salting accounts for the majority of the fish treated.

Salt is not poisonous to bacteria, but it halts or slows bacterial action in the fish flesh by lowering the water level to a point that the bacteria cannot act.

Dry salting can be used to treat almost any type of fish. This and all other methods described work better on fish with a low fat content. Fat oxidizes and creates an unpleasant odor and taste. To prepare fish for salting, the fish are first cleaned and washed. Certain small varieties are not cleaned, but are preserved with their stomachs and other organs intact. Large fish must be cut almost in half so that they can be folded out flat. Small slits must be made in fish with thick flesh. The base of the salting container is lined with a two to three centimeter layer of salt. A layer of fish is placed upon this salt, with extra salt rubbed into the stomach cavities. These fish are then covered with a thin layer of salt. The process is repeated until the container is full. A two to three centimeter layer of salt is spread over the top, over which is placed a loosely-woven bamboo lid with weights to press down on the fish. Salt equal to 25-30% of the weight of the fish is used. The salt draws the water from the flesh of the fish and forms a thick brine. Sometimes the fish and salt are placed in baskets and the brine is allowed to run off in a process known as "kench salting". More commonly, the fish and salt are placed in solid containers for 24-72

hours, the larger the fish the longer the period. Then the fish are taken out and the excess salt is washed off with clean water. The fish are then sun dried for one to seven days, with the larger fish requiring the longer time. They are dried on loosely plaited bamboo platforms which can be moved inside when it rains or at night. Each night the fish become wet because the salt draws water out of the atmosphere. The fish are considered sufficiently dry when pressing on the flesh does not release any moisture. The finished product, *ikan asin*, lasts up to three months.

Ikan peda is salted just like *ikan asin*, but is not sun-dried after salting. After the fish are removed from the salting container they are washed with fresh water and air-dried. Then they are set in layers in a box lined with banana leaves. Additional salt is sprinkled on each layer. The top is closed with banana leaves and the box is stored in a cool shady place for a week to ten days until a characteristic smell indicates that the *ikan peda* are ready. The fish are removed from the box and the excess salt is washed off. *Ikan peda* last from two weeks up to two months.

Ikan pindang is a particularly delicious preserved fish. There are several different ways of making it. It is best suited for small to medium size fish, *ikan lemuru* being the most common type used. Most fish are cleaned and washed: sometimes small fish are not cleaned, but treated with their stomachs intact. They are arranged in layers in large clay or copper cookpots, with a thick layer of rice straw in the bottom to keep the fish from burning. An amount of salt equal to about 20-30% of the weight of the fish is spread over each layer. Water is then added until all of the fish are covered. The pot is placed on a tire and the contents are boiled until the flesh around the tails of the fish begins to crack. The water is then poured off and additional salt is spread over the top of the fish. A small amount of water is added and the fish are cooked again for about a half hour, until the water is boiled away. The *pindang* is transported to market in the cookpots. Well made *pindang* can last for up to three months.

Fishermen can also make *pindang* using sea water while still out at sea. Additional salt is not necessary. The pot, large enough to hold 10

to 12 kilograms of fish, is lined with rice straw and then filled **with** fresh cleaned **fish**. Sea water is added until **the** fish are covered, and the pot is brought to a boil until the **fish** are cooked. **The** excess water is then poured off. This ***pindang laut*** **can only** last for a few days.

A third method uses steam to cook the ***pindang***. The cleaned fish are first soaked in a saturated brine solution for **30** minutes. The fish are then placed one layer **thick** on bamboo steaming racks **and air dried**. **These** racks fit into metal boxes, up to **40** layers deep. These boxes, **with** steam **vents** in the tops and bottoms, are placed **on** top of large pots of boiling water. Every fifteen minutes the trays are rotated so that the tray on top is moved to the bottom and the other trays are moved up one notch. After about an hour of steaming, the flesh of the fish becomes shiny and somewhat hard and dry. The ***pindang*** is transported to market still in the racks. Although this type of ***pindang*** **can only** last one or **two** weeks, it is popular because of **its** excellent taste and texture.

Post-Harvest Processing and Cooking Utensils/ Pengolahan Lepas Panen dan Perkakas Masak

Musim paceklik is the name given to the time when the crop is nearing maturity, but people have little to eat because the previous harvest has already been depleted. The reduction of losses to rodents or mold during storage is of ***eat importance** to villagers to **assure** a short *musim paceklik* **free** of hunger.

Most food processing methods are as simple as **they** are ancient. Nearly every village kitchen has a rack for the storage of sun-dried corn and **cassava** above the **cooking** fires. The heat keeps the **foodstuffs** dry in the humid climate, and the smoke drives away insects. The importance of this simple system became quickly apparent to development workers who were **promoting the** use of fuel-efficient **wood-burning** stoves in Central Java. The stoves have chimneys to carry away smoke and create a draft for more efficient combustion of the **fuel**. **But** the villagers had to burn up amounts of **wood** equal to the savings from the new stoves to provide the heat and smoke necessary to preserve their food stores!

There are other examples of the negative impact of new technologies on traditional food processing methods. Traditional rice varieties **are tied into small bundles as the rice is cut**. The rice is then sun dried, transported and stored in these bundles, which can be temporarily stacked outdoors **and** are rain resistant. Farmers **claim smaller losses** to rodents when they store **their** rice in bundles. However, high yielding "miracle" rice grains fall easily from the **stalks**, and therefore cannot be stored in the traditional way. To prevent losses, the new rice varieties **must** be threshed in the field and transported and stored in sacks. If the rice stored in sacks is **still** a bit **too** moist, heat generated by bacterial activity in the sacks causes the rice to take on a yellow color and an unpleasant smell and taste.

Ingenious **food** processing techniques are important in supplying protein in the villager's diet. Fish preservation methods such as salting and **drying** are vital if fish is to be an important part of the diet of the poor. Soybeans are another important **source** of protein, but the beans **are** not very palatable in their original

form. *Tempe* and *tahu* are delicious soybean products which nearly everybody can afford.

As agriculture in Indonesia moves more toward a money economy, cash crops play increasingly important roles. But if the farmer sells raw unprocessed materials, his portion of the final price is very small. Small-scale post-harvest processing technologies are necessary to assure that the farmer can sell partially processed or finished products, and receive his fair share of the **final** selling price.

Rice **Thresher/Perontok Padi**

High yielding rice strains and other new strains resistant to leaf hopper and various diseases require changes in traditional rice harvesting, transport and storage practices. With most of these new rice strains, the grain drops easily from the stalks once it is ripe, hence the name *padi rontok* ("rice which falls off"). Most of Indonesia's local rice strains cling tenaciously to the stalks, even after harvest. Traditionally, rice has been harvested one stalk at a time using an *ani-ani finger* knife. The stalks are then tied into small bundles which are easily carried and stacked for storage. Farmers claim that rice stored in this fashion is resistant to rain, mildew, rats and other pests. *Padi rontok*, by contrast, is harvested much more rapidly using small scythes called *sabit or arit*. This rice must be threshed right in the **field**, because transporting bundles of stalks would mean the loss of too much grain.

Farmers in many areas simply beat handfuls of freshly cut rice stalks against a mat placed on the ground, or on a wooden rack set on the mat. This is tiresome and time-consuming work. In the past few years a number of simple home-made threshing machines called *perontok padi* have appeared in several areas in Java and **Sumatera**. These threshers have rapidly rotating drums covered with nails to beat the rice from the stalks. All of the different models have several basic components:

1. The spinning drum is made of wooden slats nailed to **two** wooden disks. 5 cm nails are driven **partway** into these slats, at 3 cm intervals. The drum spins on two halves of a bicycle hub set into the center of the end disks. The drum measures 20-30 cm in diameter and **20-50** cm wide.

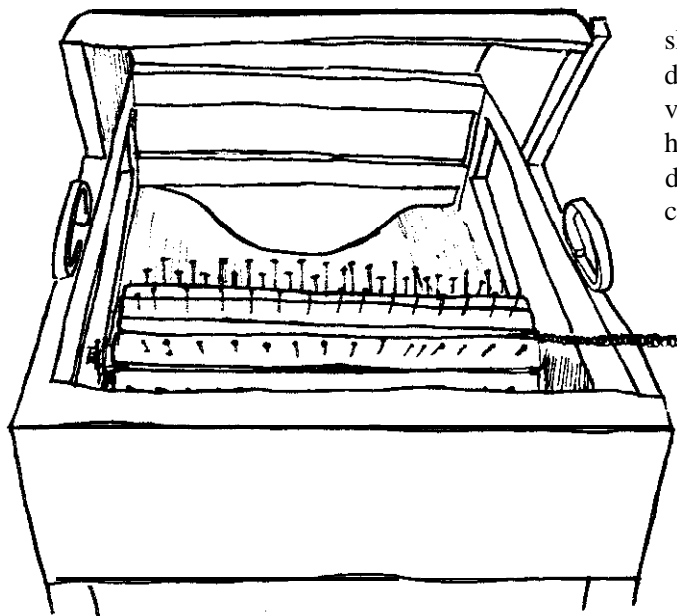
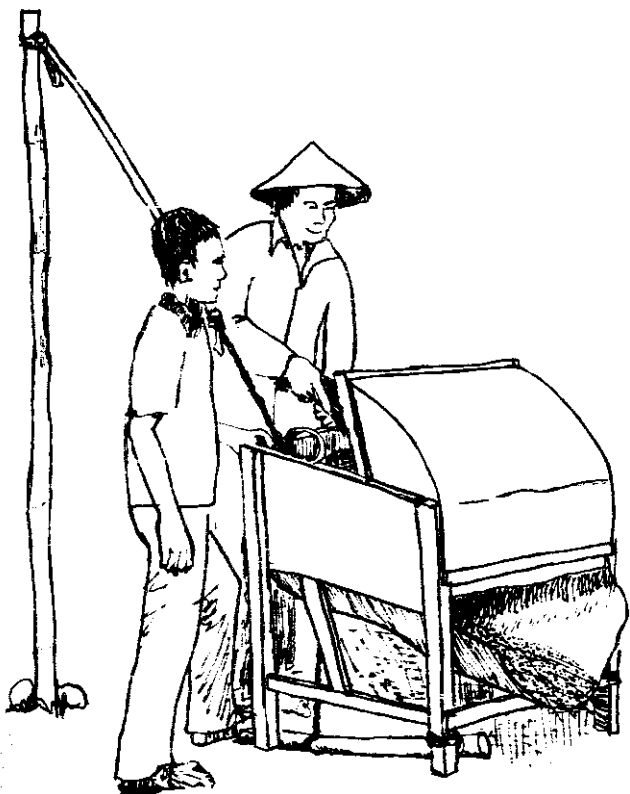

2. The drums are foot-powered. There are several different types of drive mechanisms. One type uses a "freewheeling" rear hub and sprocket from a bicycle. a bicycle chain broken open so that it no longer forms a loop, and a section of bicycle inner tube as a spring. One end of the chain is fastened to a wooden treadle, which is loosely nailed or lashed to the thresher's back leg. The inner tube is tied to the opposite end of the chain, and also to a pole set up behind the thresher, or to the bottom of the front leg of the thresher. This latter arrangement is superior: it **allows** the thresher to be transported without having to move the bamboo pole too. The tension of the inner tube spring holds the end of the treadle about 15 cm above the ground. **When** it is pressed down the chain sets the drum spinning. It keeps spinning while the pedal is released and pulled back up by the inner tube. Operation of this thresher is easier with two people, one to work the treadle, the second to hold the bundles of rice over the spinning drum.

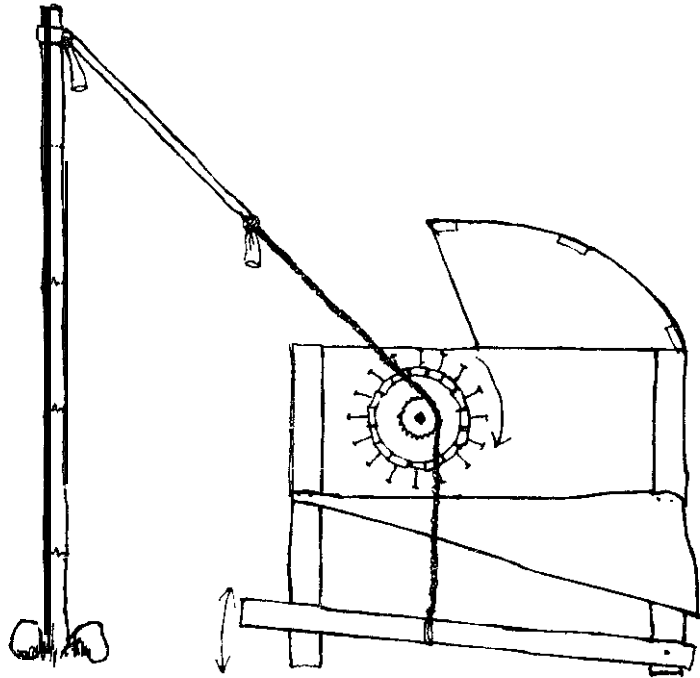

A second type of drive mechanism also uses a reciprocating treadle. The drum has an iron bar axle; one end of this axle is bent into a crank with a 6 to 8 cm radius. The crank is connected to a flat **wooden** treadle with a bicycle pedal arm or **some** other sort of connecting rod, preferably **one with** ball bearings in the end loop. When the drum is set spinning, the pedal moves up and down rapidly. This type of thresher can be operated by one person, and it requires less effort than the previous design to keep the drum spinning rapidly. Unfortunately, the design shown here is too low, requiring that the operator bend down to hold the rice over the drum. **This** is solved with the addition of four legs and a longer connecting rod between the crank and **the** treadle. **This** is the cheapest and most efficient design.

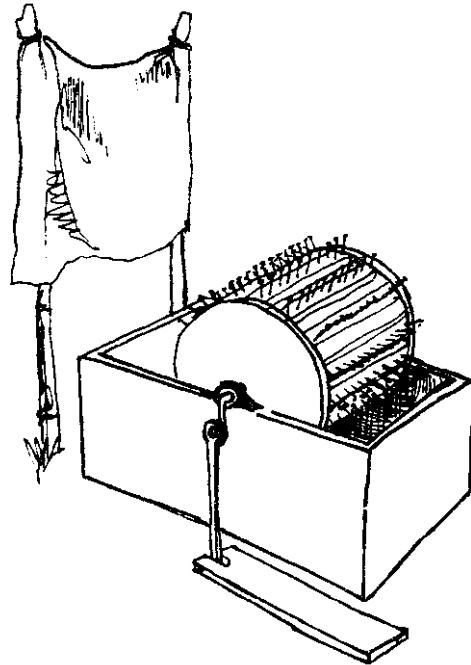

With **the third** type of drive mechanism, the operator sits on a wooden bench and pedals a bicycle crank and chain wheel with both feet. The chain drives a bicycle rear drum and sprocket, to which is welded a second front chain wheel to increase the speed of rotation. **This** second chain wheel drives a chain which turns another sprocket and rear hub to which the drum is fastened. In this manner, a slow rotation of the pedals causes the drum to spin very rapidly. conserving the operator's

Chain-driven bicycle rear hub and sprocket, used to step up the speed of rotation on pedalled thresher.

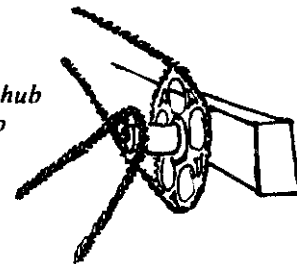

strength and allowing him to hold the bundles of rice stalks over the spinning drum.

3. Each type of thresher has a sturdy wooden frame. Size and weight are kept to a minimum to allow the threshers to be easily transported to fields currently being harvested.

4. The different threshers have different types of catchments and chutes to confine and gather the rice as it flies from the spinning drum. The first model has a sheet metal hood covering the back half of the thresher, and a curved sheet of the same material on the bottom, slanted downward away from the operator. The threshed rice falls into a pile behind the machine.

The second model is open, employing only a piece of burlap sack hung behind the machine which catches most of the rice as it flies away from the drum. Better models of the same type of thresher employ a hood and chute just like the previous example.

The third model also has a hood over the drum, in this case a removable wooden box open at the front. Below the drum, the rice falls onto a steeply slanted wooden chute and down into a pile behind the machine.

As the rice is cut, the workers bring loose bundles of rice stalks and hand them to the operator, who presses them to the spinning drum, twisting and turning the bundles until almost all of the grains have been stripped off. The bundle of empty stalks is then tossed away into a pile and the operator grabs another fresh bundle to thresh. In this manner the threshing is completed very quickly. Owners of threshers rent their machines out to other farmers for a small fee.

These *perontok padi*, appearing spontaneously in several different forms in different areas over the past few years, provide us with a striking example of the ability of rural Indonesians to respond to changes in agricultural technology needs.

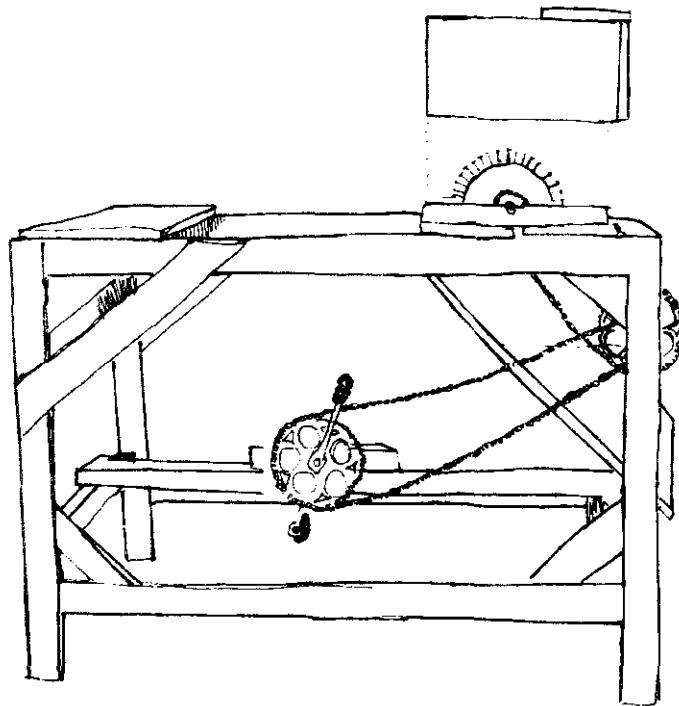

Rice Pounding Watermill/ Kincir Air Penumbuk Padi

While more and more of Indonesia's rice harvest is taken to diesel-powered mini-hullers for processing, in West Sumatera many traditional waterwheel-powered rice pounders are still in use. Even there, hullers are gaining popularity in areas with sufficiently large harvests to justify their use, or areas served by good roads. But away from the main highways the valleys still echo with the pleasant splashing and thumping of the traditional rice pounders.

For the farmer there are a number of factors determining his choice of where to hull his rice. The owners of hullers charge more, taking 10% of the finished product compared to the 5% charged by owners of watermills. But

the farmer can sell his huller-processed rice for a better price at the market, as it is cleaner and has fewer broken grains. Mechanical hullers are also much faster and can handle large volumes of rice in the time a watermill needs to pound enough for one meal. From the point of view of nutrition, however, watermills and hand-pounded rice offer a distinct advantage: the rice does not get as completely milled, and some of the vitamin-rich bran and germ is left on the grain. In Java, vitamin deficiency diseases such as beri-beri are on the rise, in part because rice that was once hand-pounded is now taken to the huller.

The Sumateran watermills are driven by breastshot wheels with diameters of 2 to 3 meters. They turn at a rate of 10 to 30 revolutions per minute, depending on the water flow. The wheels are made from Surian wood, a fairly hard wood which remains very strong when

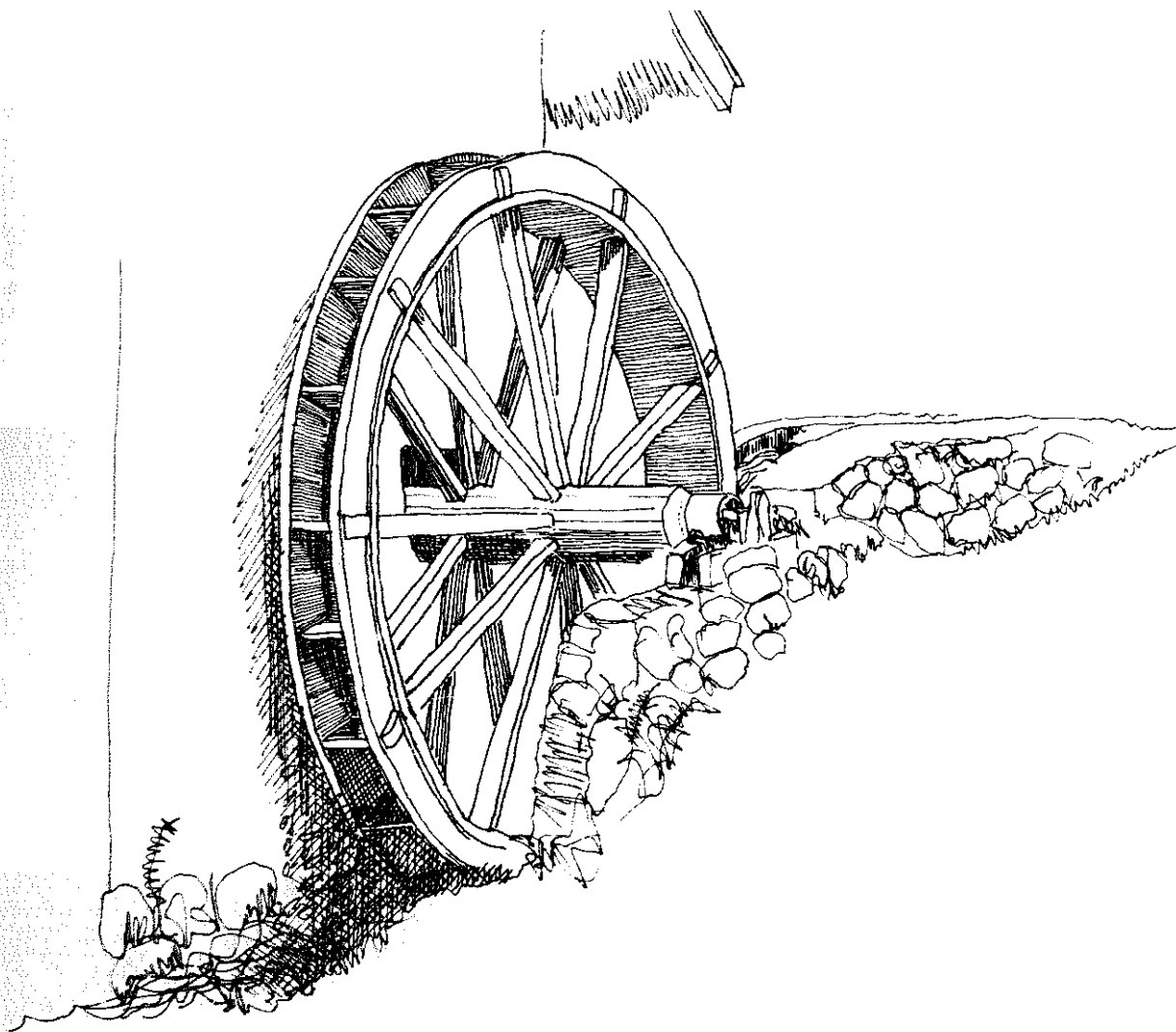

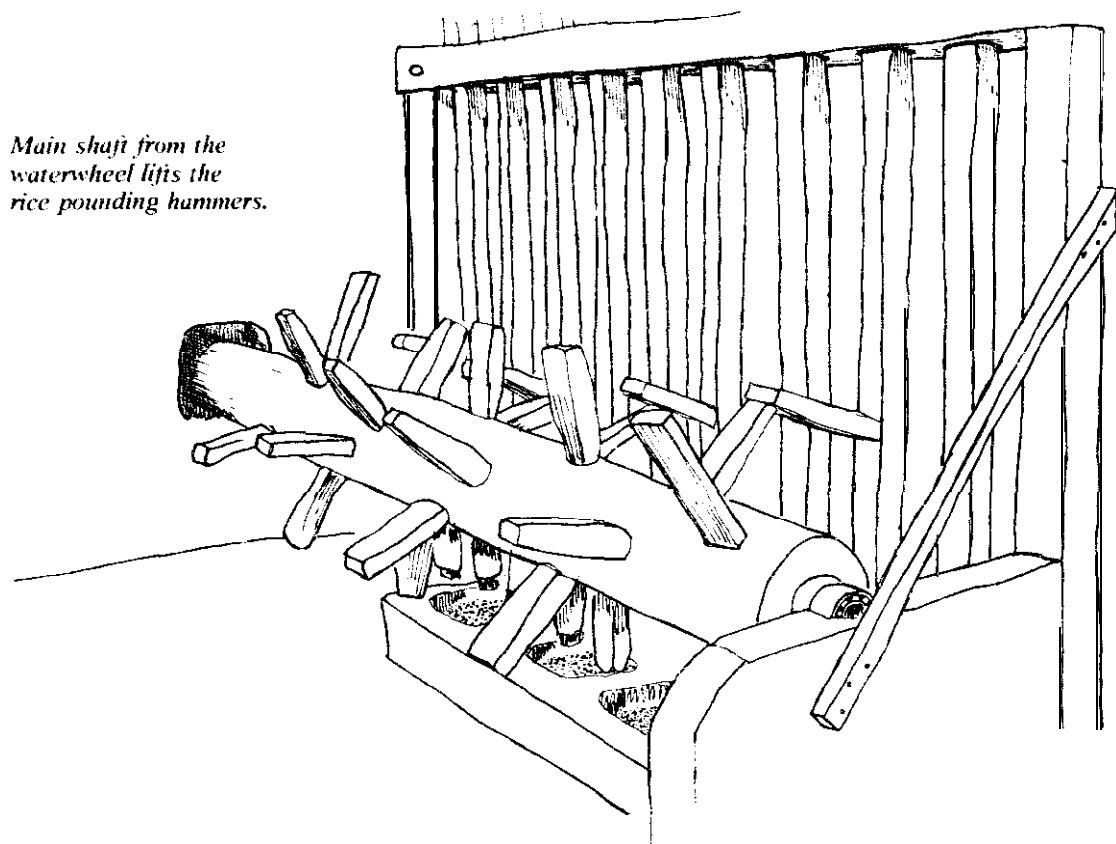

Main shaft from the waterwheel lifts the rice pounding hammers.

wet. **The wheels have 20 or 24** buckets and 20 or 24 spokes, arranged in pairs. The heavy 3 or 4 meter shaft is also made from **Surian** wood. The oldest wheels have iron sleeves on the ends of the shafts, which **turn in grooves in wooden** blocks. Newer wheels have ball bearings on one or both ends. Either a large bearing is **fitted** onto the end of the shaft, or **the** block is fitted with **two or three smaller** bearings, and the iron sleeve on the end of the shaft sits upon these bearings.

One end of the main shaft enters the room where the rice pounding hammers are located. For each hammer, the shaft has three wooden paddles set at 120° apart around the shaft. One **by** one the paddles come up below a horizontal arm connected to the hammer, lift the hammer, and drop it as the paddle revolves past the end of the arm. The hammer drops about 20 to 30 cm into the rice, then is picked up by the next paddle. These sets of paddles are about 20 cm apart, and the number of sets is determined by

the amount of water available, and the **corres-**ponding limitations on the wheel's ability to lift the rice pounding hammers.

continued..

The hammers slide through rectangular holes in two parallel horizontal beams, one near the top of the hammers and one near the base. Below the hammers is a wooden or masonry container for the rice, divided into several howls into which one or two hammers fall. Each bowl holds about six liters of rice. To stop a hammer, it is lifted up and a pin is slipped into a hole near the base of the hammer, preventing it from falling or being lifted by the paddles.

It takes one to three hours to pound rice by this method. The slower mills cause less grain breakage than those which turn faster and lift the hammers higher. The pounded rice must be winnowed to remove the husks and bran.

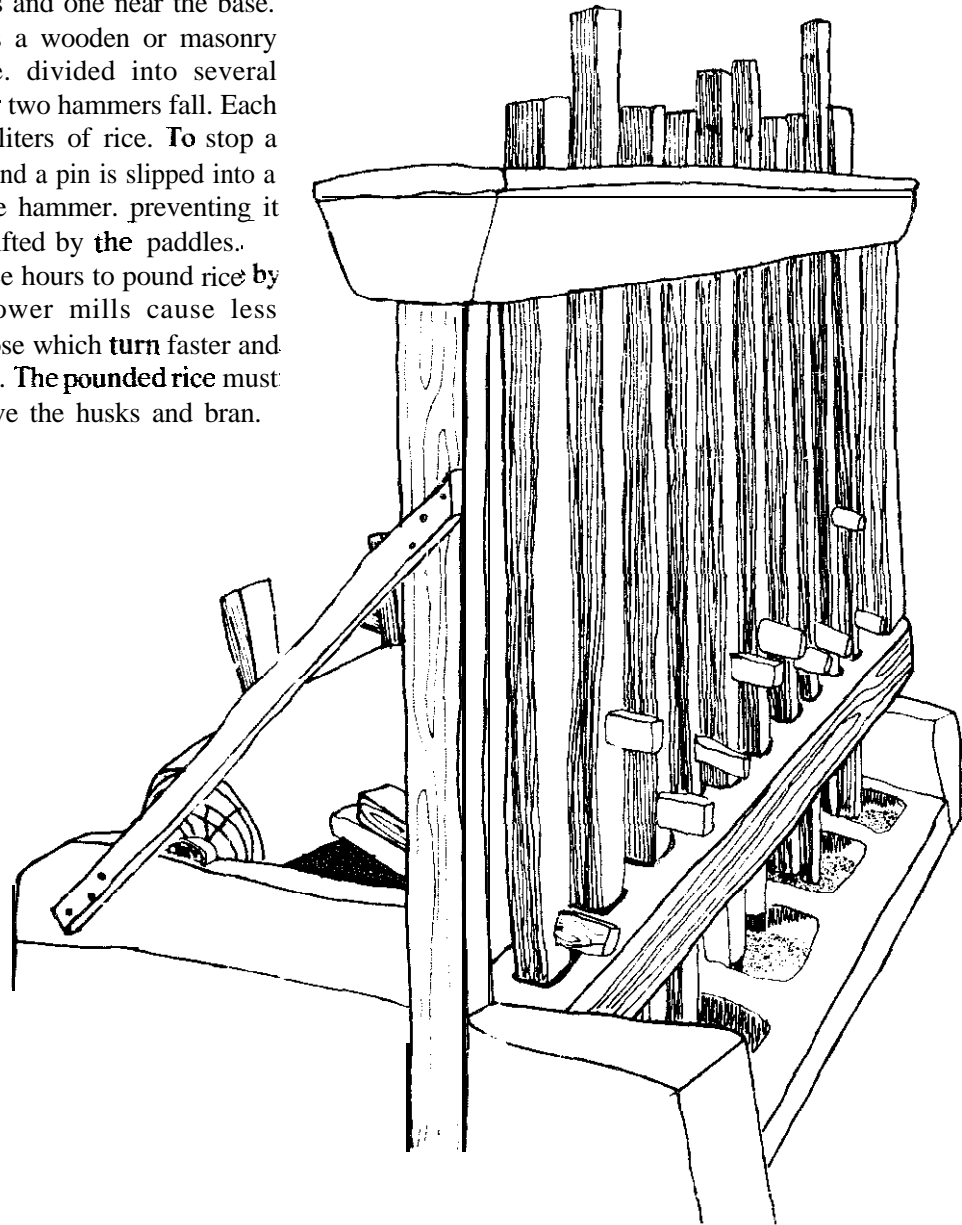

Winnower/Kipas

Every West Sumatran watermill owner also has a *kipas*, a winnower used to separate the pounded rice from the husks and bran. This *kipas* can also be carried to the field at harvest time to separate threshed rice from chaff.

Construction and operation of the *kipas* is quite simple. A hand-cranked four-bladed fan creates a strong wind through a box-shaped passage. The rice is put into a hopper on top of this passage and allowed to trickle slowly down through a slot in the top of the passage. The rice falls almost straight down while the chaff, husks and bran are blown out the end of the passage. The rice falls into a slanted V-shaped channel which dumps it into a container set on the ground. Some *kipas* have two of these channels, one very close to the fan which catches the majority of the clean rice, the second to catch the rest of the rice which is still mixed with impurities.

After passing through the *kipas* one time, the rice still has some husks and bran mixed in with it, and the process must be repeated three or four times before the rice is completely clean.

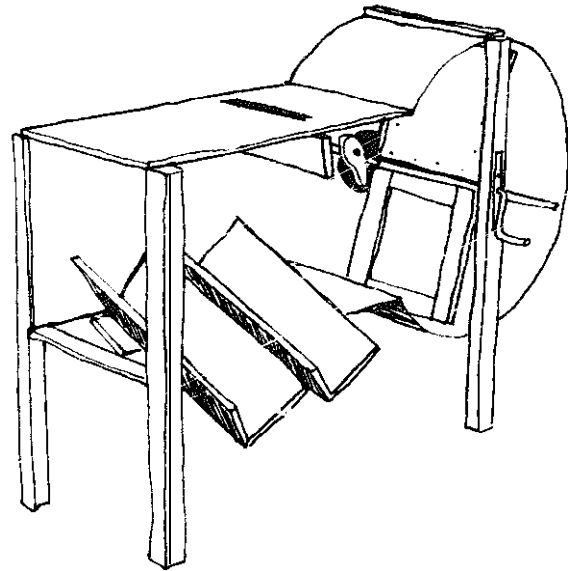
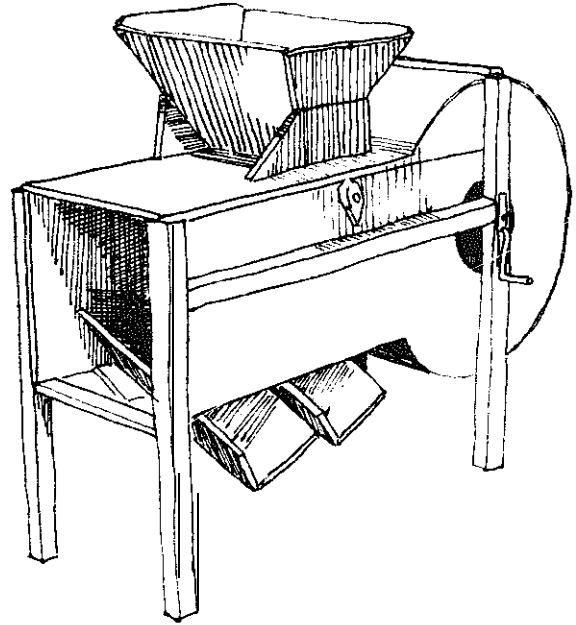

Corn Grinders/Gilingan Jagung

In several areas in Indonesia, corn is used to supplement or replace rice as the main food, either all or part of the year. Dried corn must be ground or pounded into *beras jagung*, a coarse corn meal, before it can be boiled and eaten. Corn should be stored whole, because cracked corn is quickly attacked by insects. Many people keep their corn on the cobs in racks above the cookstoves. The heat assures that the corn is dry and free from mold and mildew, and the smoke keeps insects away.

Many people pound their corn as they need it, in a *lesung*. But this is very heavy and tedious work, and in several corn growing areas the people use simple hand-turned grinders for their corn. These grinders differ in size and shape in different areas. Two common types are explained below.

Vertical cylinder grinder from Gunung Kidul:

This type of grinder breaks up the corn between concentric iron cylinders with deeply scored grinding surfaces. The corn is usually still rather coarse after passing through this grinder, and most people pound it a bit more after grinding. However, they claim that this is much easier than pounding whole corn. The grinder consists of 5 parts:

1. A wooden crank at the top is turned to grind the corn.
2. At the lower end, the crank shaft is fitted with an iron sleeve about 10 cm long, with a diameter of about 4.5 cm. The surface of the iron has parallel grooves about 2 mm deep and 4 mm apart.
3. The sleeve fits into another iron cylinder that is slightly conical in shape, also scored with parallel lines. This creates two grinding surfaces facing one another. The diameter of this cylinder is about 5.5 cm at the top, tapering down to 5 cm at the bottom, so that the gap between the two decreases.
4. A sheet metal cone fastened above the outer cylinder acts as a hopper for the corn.
5. A sturdy wooden frame holds all of the components. The frame is planted in the ground. Sufficient space must remain under the grinder to place a bowl to catch the ground corn.

After the hopper is filled with whole corn,

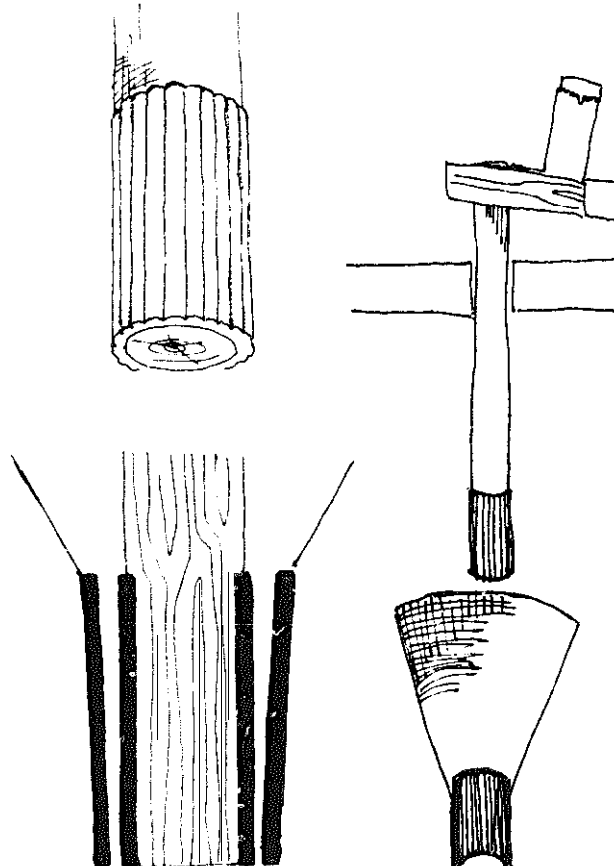
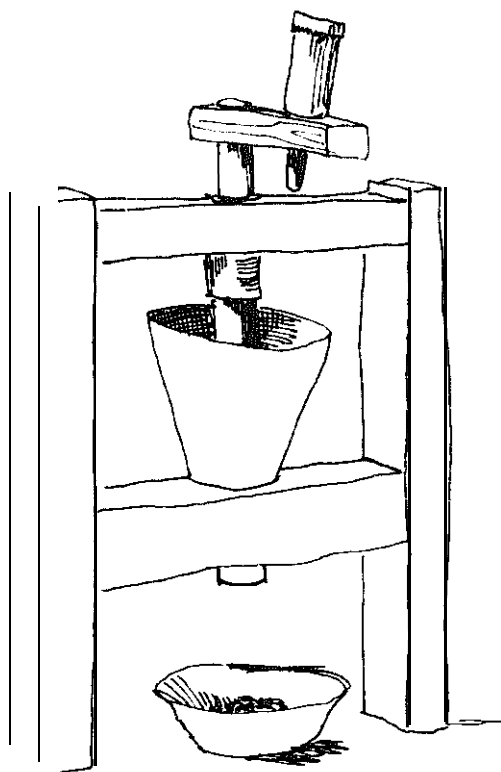

turning the crank causes the kernels to fall between the **two** iron surfaces. The inner surface rotates while the outer one remains stationary. **The** corn breaks into smaller and smaller pieces as it moves downward.

Flat grindstone from Madura:

A more common type of grinder is a set of flat grindstones, like **the** example shown here from **Madura**. It consists of 4 parts:

1. **Two circular** grindstones about 10 **cm** thick and 20 to 30 cm in diameter. The grinding surfaces of both **stones** have about 100 small indentations, 1 X3 cm across and 2-3 mm deep, chiselled into them. In **the** center of each grinding face is a 2.5 cm hole to hold the axle.

2. The upper stone has a bowl carved into the top surface to hold **the** corn. A 3 cm diameter hole pierces the stone near the center. **Corn** falls **through** this hole to the grinding faces as the upper stone is turned.

3. A wooden peg fits snugly into the hole in the bottom stone, and loosely into the hole in the upper stone. It is long enough to hold the stones about 2 mm apart as the upper stone rotates on this **axle**.

4. A **straight wooden** handle fits **into** another hole in the side of the upper stone. The handle is about 30 cm long and points upward.

Corn is placed in the bowl in the top of **the** grinder, and the upper stone is turned using the handle. The corn falls down the hole through the upper stone and is ground between the two stones. The rotation of the stones moves the corn particles towards the outer edges of the stones. Finely ground corn eventually falls out the edges to a mat or large bowl placed under the grinder during use.

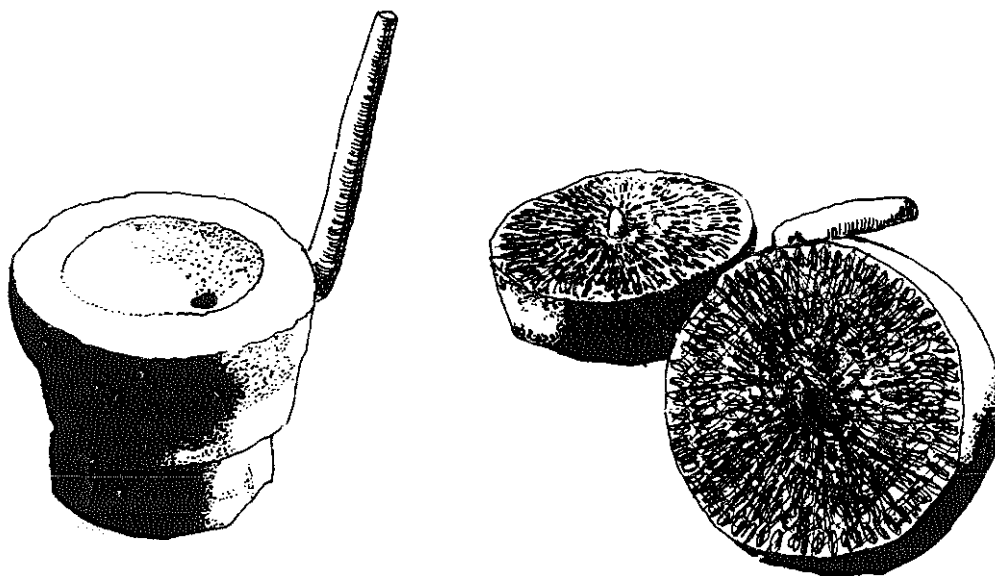

Cultured Soybean Cake/Tempe

Tempe is a delicious and nutritious food made from cultured (**fermented**) soybeans. It is one of Indonesia's most important foods, and may be one of Indonesia's most significant contributions to the **people** of the developing world.

Tempe contains almost 20 percent protein and is one of the richest known vegetable sources of **vitamin B 12**, a **vital** nutrient **usually** lacking in meatless diets. *Tempe* is easily prepared and easily digested.

Tempe production processes are best suited for small cottage industries. The process has several steps and takes about 3 days. No special tools or skills are required. *Tempe* is made from clean dried soybeans and inoculated with *Rhizopus* mold spores. (The procedure for preparing *Rhizopus* culture is explained following this description of tempe production.) Large **cookpots**, baskets, buckets, trays, and a set of shelves for incubation are all that is required for *tempe* production. In cold climates, heated incubators **will** be necessary, but in almost all tropical areas, open shelves are sufficient.

To start the process the beans are washed, then put in a large container and covered with water, 3 to 5 cm over the top of the beans. The container is brought to a boil and simmered for about 30 minutes. The foam on top of the boiling beans is skimmed off. After this first boiling, the beans are only partially cooked; they are soft enough that the skins can be removed easily, but the beans **will** not mash. The beans **are then** poured into large baskets to drain.

On a **dean**, sloping tile or cement floor with drains to **carry** away waste water, **the** beans are poured into square bottomed baskets. After dousing with water until the beans are cool enough, workers wash their feet and step barefooted into the basket. Supporting **themselves** on water tanks, the workers begin to tread upon the beans, splitting the beans and separating the skins. Every 3 to 5 minutes they pour a few buckets of water over the beans and rock the baskets to mix the contents. After about 30 minutes nearly all **the** skins have been removed from the beans. Small amounts of

beans in small baskets require only a few minutes for this process.

Boiling soybeans.

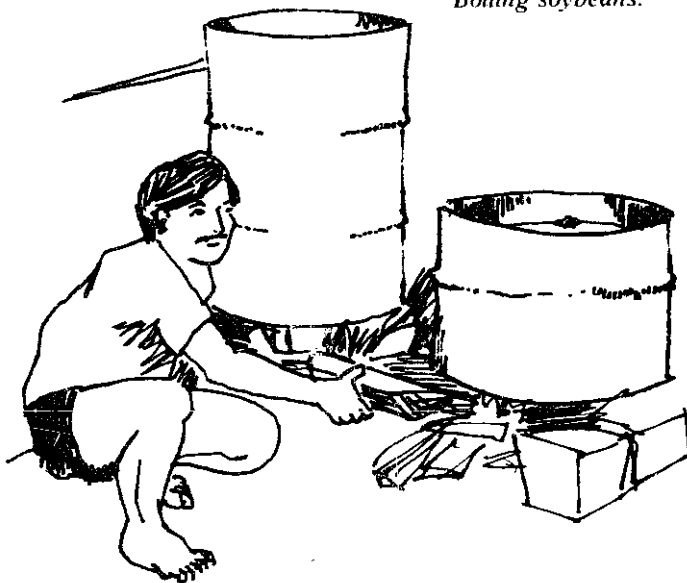

Separating the skins.





The beans are now ready to be cleaned by floating off the hulls. Some producers leave out this step, making *tempe* with the hulls still mixed in with the beans. This *tempe* can be sold cheaper because of the labor saved during production, and is slightly more nutritious, but most people feel that *tempe* without any hulls tastes much better, and are **willing** to pay the slightly higher price.

To separate the hulls from the beans, small amounts are scooped into a shallow round basket. Then they are immersed in water and stirred with one hand. The bean halves sink back onto the basket, leaving the hulls still swirling in the water. The basket is tilted and lifted slowly out of the water, leaving most of the hulls behind. This process is repeated 2 or 3 times until nearly all of the hulls are removed.

If a clean source of running water is available it is easier to clean the beans, floating the hulls downstream by stirring the beans in a basket while it is slowly lowered into the current.

The cleaned beans are returned to the cooking pots, covered again with water, and allowed to soak for 24 hours. A little bacterial fermentation takes place, slightly acidifying the water.

Without changing the water, the beans are then brought to a boil and simmered for 30 minutes.

The beans are then poured into large baskets to drain for a few minutes. After this they are spread about 8-10 cm deep on large flat basket trays, and allowed to cool for an hour or two. They are stirred occasionally so that they cool and dry evenly.



Next the beans are inoculated with *Rhizopus* mold spores. Most *tempe* producers use *waru*, hibiscus leaves specially prepared with *Rhizopus* inoculum. Two *waru* leaves are needed for each 20 to 30 kg of dry soybeans used. The leaves are rubbed together over the beans. Then they are rubbed over the surface of the pile of beans for 3 or 4 minutes until all the spores clinging to the leaves have been transferred to the damp beans. The beans are then mixed by hand for several minutes to distribute the spores evenly.

The beans are now ready for incubation. This is done at room temperature in most areas in Indonesia, about 25 degrees Centigrade, or about 77 degrees Fahrenheit. In colder climates, a heated incubator is needed to maintain this temperature.

To incubate the *tempe*, the inoculated beans are either wrapped in small packets or spread in shallow trays. Traditionally, 25 to 50 grams of the inoculated beans are wrapped in banana leaves which have been perforated with small holes. The leaves are then folded and

Inoculating beans.

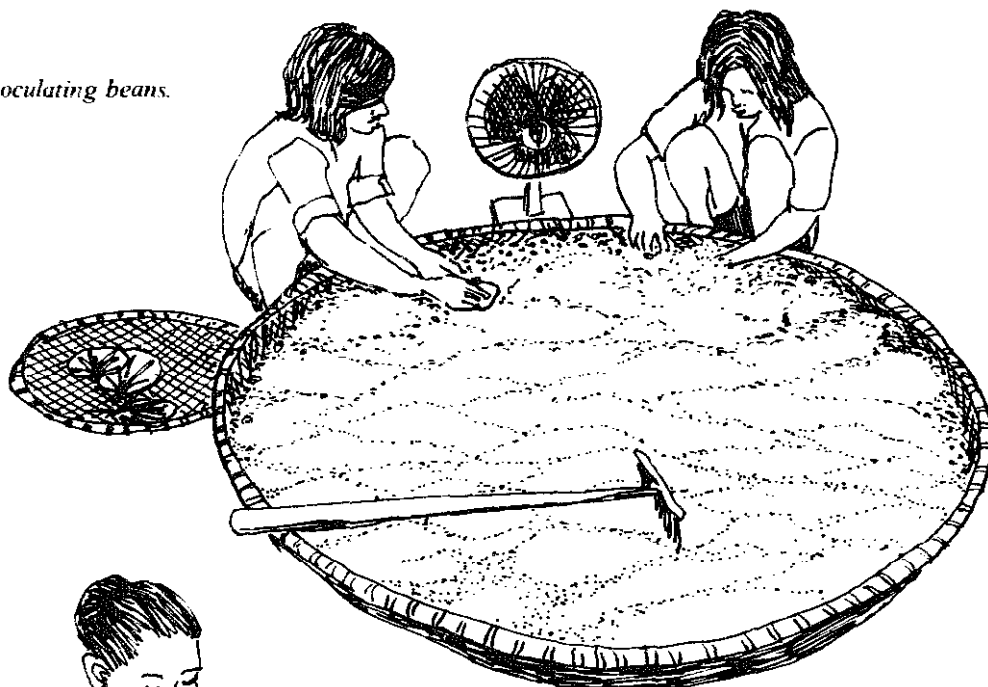

Wrapping tempe in banana leaves for incubation.

tied. Now, many producers prefer to wrap their rempe in plastic bags for incubation and sale. Like the banana leaves, the plastic bags must be poked full of small holes before filling with beans.

The small packets are then arranged on slatted shelves with good air circulation and allowed to incubate at room temperature for 36 to 48 hours, until the *tempe* is done. The finished *tempe* is ready for consumption or sale in the packets used for incubation. *Tempe* incubated in trays must be cut into rectangular pieces for transport and sale.

Good finished *tempe* is cohesive, holding together in a firm brick. Thin slices should not crumble easily. The beans are bound together by dense, uniform white mold. The *tempe* should have a pleasant, sweet mushroom-like aroma. Good *tempe* is best if fried or cooked in soups. Unripe *tempe* crumbles easily when sliced; it should be incubated longer. *Tempe* with black or grey around the edges has been incubated too long; many people still enjoy eating this more pungent product. If there is an odor of alcohol or ammonia and a slippery or mushy texture the *tempe* has rotted and should be discarded.

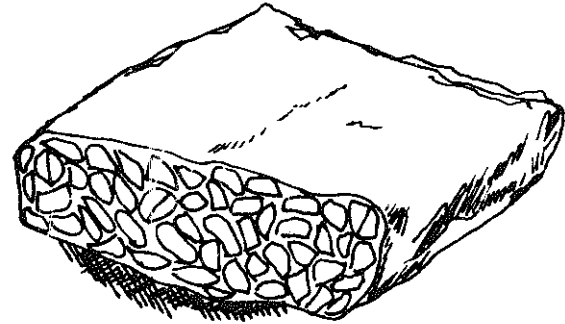

Cross section of finished *tempe*.

Inoculum for Soybean Cake/Waru

Waru, rempe inoculum prepared on the backs of leaves, is the type of inoculum most commonly used by Indonesian *tempe* manufacturers. It is produced with a few inoculated beans set aside during the *tempe* manufacturing process. Therefore, in order to produce *waru* for rempe manufacture, some inoculum or *tempe* must first be obtained.

In Java and other areas of Indonesia where *tempe* is common, *waru* can often be bought at the market or obtained from other producers. If not, *tempe* can be used. In those areas where *tempe* is not being produced, *waru* or other forms of inoculum can be obtained from the Department of Agriculture. *Tempe* inoculum is now becoming available in many countries outside of Indonesia, too.

If powdered *tempe* inoculum is available, it can be used to produce a first batch of *tempe*, after which the producer can make his own *waru*. Making *rempe* with powdered inoculum

is the same as the procedure described above, except that instead of rubbing the cooked beans with *waru*, the inoculum is sprinkled on. The amount used varies with the concentration of the different types of powdered inoculum: be sure to obtain specific instructions about how much to use from the source of the inoculum. When wrapping the inoculated beans for incubation, a few handfuls are set aside for *waru* production.

If fresh *tempe* is available, it can be used to make inoculum. The *tempe* is sliced thinly and loosely wrapped in banana leaves or plastic and incubated in a warm damp place until the mold sporulates 1 to 3 days later. Sporulated *rempe* is grey or black around the edges, especially those areas around the holes in the wrapper. It can then be crumbled and used directly to inoculate new *tempe*, or sun-dried and ground to be used later. This method is sometimes difficult; often the *tempe* will rot and not sporulate. All tools

and materials **must** be kept clean and air **circulation** must be good to insure proper incubation. Properly **sporulated tempe** should be covered with fine mold hairs which are almost black with spores.

Fresh hibiscus leaves, called *waru puteh* in Java, are used to make the **inoculum**. This tree grows throughout the country. Sometimes teak leaves are used; **like** hibiscus, the leaves are large and the undersides are covered with fine hairs to which the **mold** can cling.

In a **flat**, shallow tray lined **with** a layer of perforated banana leaves or plastic, hibiscus leaves are **placed** upside **down**, with the hairy sides facing up. On each leaf is sprinkled about 40 inoculated soybeans. These sprinkled leaves are then covered with another leaf placed with the hairy side down, sandwiching the beans **between** two leaves. Another layer of leaves is **spread** over the top of these first sandwiched pairs and the process is repeated. After 3 or 4 layers of sandwiched pairs, the tray is covered **with** perforated banana leaves or plastic.

Several trays are stacked for about 6 hours, becoming warm from **fermentation**. Then the trays are unstacked, set on slatted shelves for good air circulation, and left for another 24 hours or more, until the mold has sporulated.

Next, **the** pairs **of** leaves are removed **from** the trays, set out on shelves in a single layer and allowed to stand for 3 to 7 days, until the leaves are **dry** and the edges are beginning to curl back. If the pairs of leaves are lightly bound together, **the** inside surfaces are covered with black or dark **grey** mold, and the individual bean particles are firm and dry, the *waru* is ready for use.

Waru **stores** well, though it does lose some strength over the first month or so of storage. It should be kept in a cool dry place, such as on the rafters of a kitchen.



Hibiscus leaves used for tempe inoculum.

Soybean Curd (Tofu)/Tahu

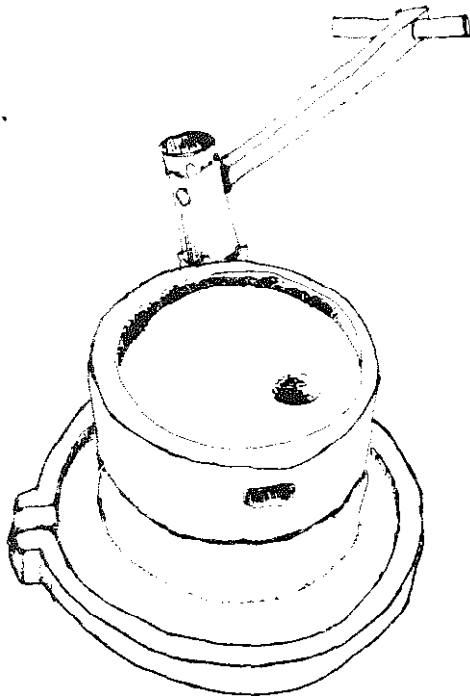

Soybean grinder for tahu production. Grinding face diameter is 20-30 cm. Top stone is 12-15 cm thick, with a dish cut 4 cm deep on the top for the beans. The bottom stone is 10 cm thick, with a trough 4 cm wide and 3 cm deep, and a 2 cm lip.

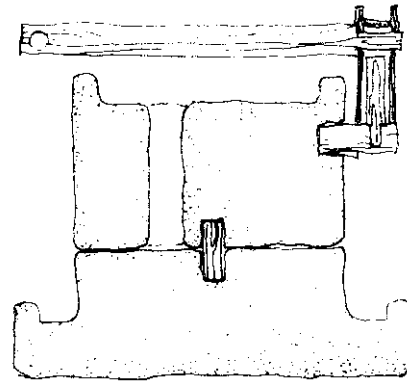

Soybean tofu, called *tahu* in Indonesia, is an inexpensive and common protein source in many parts of the country, particularly Java. Its low price and **widespread** manufacture by thousands of small cottage industries **make** it available to most Indonesians. It was introduced by Chinese **migrants** several hundred years ago.

Tahu production is quite a **simple** process. After the beans are soaked for **twenty four** hours they are ground into a milky liquid. The soft wet beans are fed into a *batu gilingan tahu* made from basaltic stone. The upper section rotates on a **wooden** pin **long** enough to keep a small space between the two grinding surfaces, so that the two stones are almost touching. The upper stone has a hole through which the soybeans fall. The **two** grinding faces are scored with lines radiating from the center. While the beans are being ground, a small amount of water is poured over them. This helps them move easily and causes the ground material to come out as a white liquid. The bottom stone has a trough around it, with a spout on **one** side from which the liquid pours into a container.

This *air tahu* is poured into a large iron vat and cooked over a hot fire until it boils and begins to froth. Water is stirred in and the **mixture** is brought to a frothing boil a second

time.

The boiled *air tahu* is then filtered through a piece of cloth set in a cone-shaped *sankar* made from bamboo strips set in the top of a drum. The pieces of bean and skin are filtered out. To squeeze all of the *air tahu* out of the cloth, it is folded over and boards are set upon it to allow a worker to stand on **it**. **The** beans and

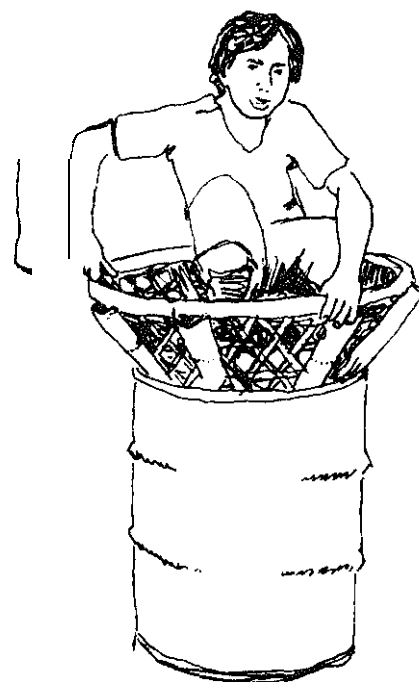

skins are **sometimes** used to make inexpensive *tempe* called *tempe gembus*, or sometimes used for animal feed.

The filtered *air tahu* is now smooth and thin. To precipitate the *tahu* solids, a small amount of vinegar is slowly stirred into the *air tahu* until the white solids separate and sink to the bottom. In subsequent batches, water from previous batches is used instead of more vinegar to precipitate the *tahu*. About one fourth of the water is saved for this purpose. The rest is thrown away.

After the water has been scooped off, the *tahu* is ready for molding into soft cakes. Two methods are commonly used. In one, handfuls of the soft *tahu* are scooped onto small squares of cloth and the edges are folded up over it.

forming a loose rectangular package. In the other, a shallow wooden tray with drain holes is lined with a larger piece of cloth, the tray is filled with soft *tahu*, and the cloth is folded over the top. Then a flat board is placed over a group of the small bundles or the top of the tray and weighted with rocks. After pressing for a few minutes to a half hour, the wrapping cloth is removed from the soft **but** cohesive cakes. **Tahu** pressed in trays must be cut into smaller squares.

Tahu is transported to market in large **square** cans tilled with water to keep the *tahu* from being smashed. It should be sold and eaten within a day of its manufacture. **Tahu can** be boiled or fried.

Cassava Peeler/

Pisau Pengupas Ketela

The most time consuming aspect of processing cassava, for drying, cooking, or grinding to make tapioca, is peeling the roots. Workers in tapioca factories can peel up to a ton or more of cassava in one day using a special knife designed for that purpose. The short rectangular blade is sharp on one edge. Bolted to the blade is a C-shaped guard, its inside edge situated about 6 mm away from the cutting

edge. As the knife is pushed along the cassava, the guard skims along the surface of the skin, allowing the blade to cut a slice about 3 or 4 mm deep, thus neatly removing the skin in only five or six strokes.

The guard is fastened to the blade with small bolts, so that it can be removed easily when the blade needs sharpening.

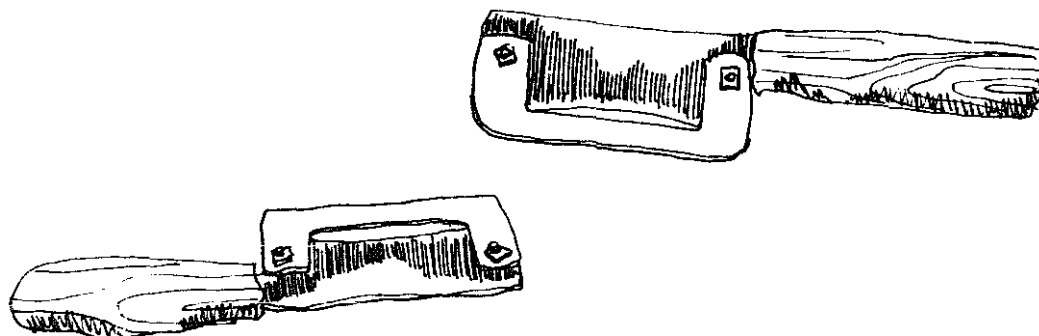

The blade and handle of the pisau pengupas are each 10-12 cm long. The blade alone is 3.5 cm wide and 5-6 cm wide after the guard is added.

Coconut Processing/ Pengolahan Kelapa

Indonesia exports **copra**, but a majority of Indonesia's coconut crop is consumed **domestically**. More than half of these coconuts are processed by villagers for their own use or for local sale in small amounts. Coconut products, especially the oil, are second only to rice in the Indonesian diet.

The first step in processing the coconut is to remove the tough fibrous husk. This is usually done with a *selambut*, a sharpened iron stake which is planted in the ground fitted into a large wooden block. The coconut is struck upon the *selambut* so that it pierces the stem end. The *selambut* is used to pry the husk off in sections.

Next the coconut is opened. A small hole in the end of young coconuts is all that is required to remove the sweet milk for drinking. To remove the meat, the nuts are cracked in half by striking them sharply with a heavy knife.

A popular drink is made from young coconut milk, sweet syrup, ice, and shredded soft young coconut meat. Bottle caps nailed to the end of sticks, or metal loops soldered into a handle are good for scraping the thin strips needed for the drinks.

A special knife is used to remove the meat of mature coconuts for **copra** production or for grating. The dull iron **blade** is perpendicular to the handle, and curved like the coconut shell. The blade is forced between the shell and the brown outer skin on the meat, then pulled around, prying the meat out of the shell in one or two pieces.

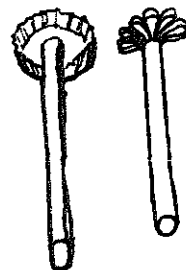
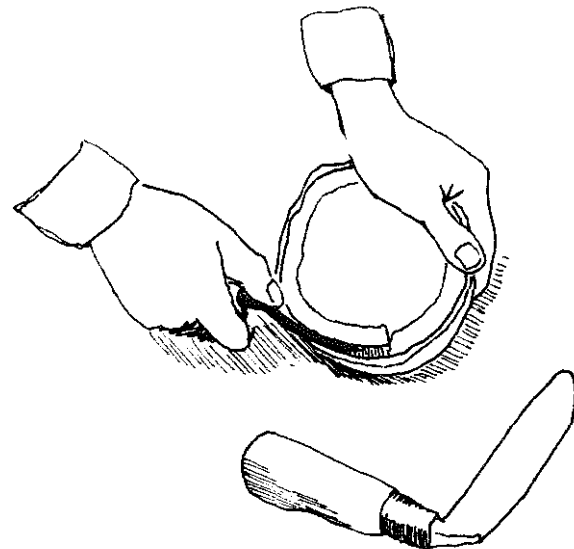
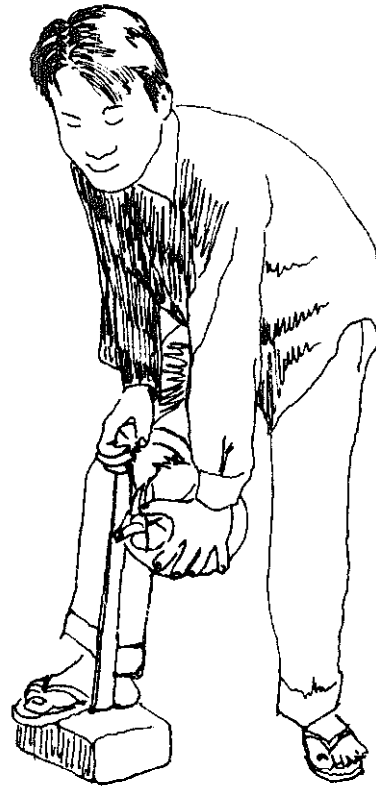

*Tools for scraping
thin strips of coconut
for drinks.*

Coconut **Graters/Parutan**

There are a number of ways to grate coconut meat. In Java, the **flat parutan** is most commonly used. Chunks of coconut meat already out of the shell are scraped across the grating surface. The grater can be made of thin sheet metal perforated with nail holes, or of wood filled with tiny wire nails, or of pieces of spiny palm stem.

Many people prefer a spoon-like **parutan** with a serrated edge, to grate the meat right out of the half shell. The simplest type is hand-held.

Larger amounts of coconut can be grated more quickly with a stool-mounted version of the same tool. The user sits on the stool and scrapes the coconut halves across the blade between her legs. A bowl is placed beneath the blade to catch the grated meat.

There is a folding version of the same tool. When not in use the blade folds under the hinged seat. Though not as sturdy as the above type, this model is preferred by mothers of small children and walking coconut venders.

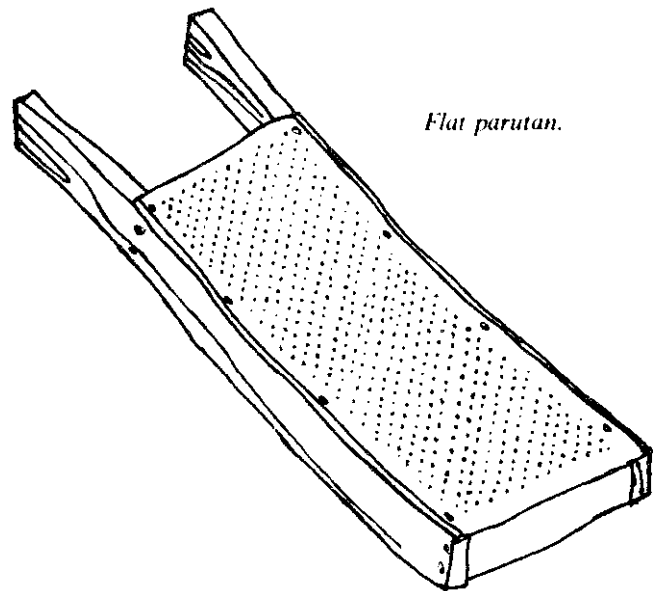

Flat parutan.

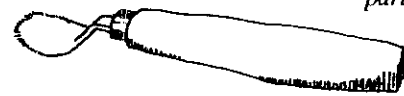

Hand held parutan.

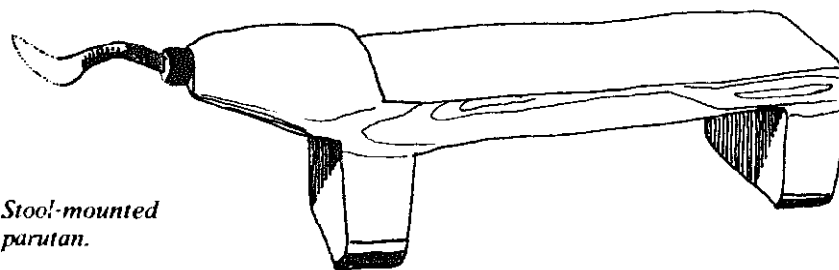

Stool-mounted parutan.

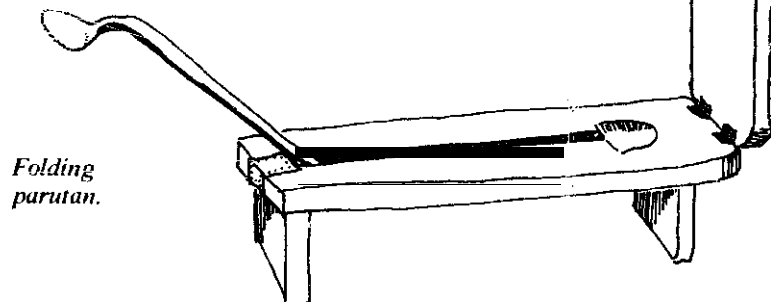

Folding parutan.

Five to ten coconuts are needed to produce a liter of cooking oil. Therefore, even a small oil-producing outfit requires tools which can grate the meat **more** quickly **than** the *parutan* described above. One of the best tools is the foot-powered rotating *parutan*.

The hardwood shaft has a head with 4 or 6 sawn slots which hold the blades. **Flat-bot-tomed** circular pieces are cut **from** thin steel plate, such as a discarded saw blade. The teeth of the blades are cut with triangular files. **Slits** are cut into the center of each blade so that they can cross each **other** and fit snugly into the slots sawn into the head of the shaft. The finished shaft then appears to have 8 or 12 serrated blades.

The *parutan* shaft is mounted in holes in the cross pieces of a **box-like frame**, shown here in cross-section. A rope, coiled three or four times around the shaft, is tied to two **wooden** poles which serve as pedals. When one pedal is pressed down 20 to 30 cm, the other is pulled up an equal distance, **turning** the shaft around two or three times. Then the second pedal is pressed down, rotating the **shaft** back the other direction, and **pulling** the first pedal up again.

The **operator** sits on a bench in the center of the **frame** so that his feet comfortably reach the **two** pedals. **With** his elbows **firmly** set upon the crosspieces, he holds a half coconut over the head of the rotating shaft. He presses down each pedal alternately, causing the shaft to rotate back and forth. By pressing the half coconut (still in its shell) **firmly** against the turning blades, the meat can be quickly shredded. An experienced operator knows when the blades are approaching the outer edge of the coconut meat and avoids hitting the shell, to keep the shredded white meat clean and pure.

A **similar** *parutan* uses a bamboo spring arching over the tool to **pull** the rope in one direction, requiring only one pedal to rotate the shaft back and forth. Most people consider this arrangement much **more** cumbersome than the two-pedal version.

Operator alternately pushes down on right and left foot pedals to work the parutan.

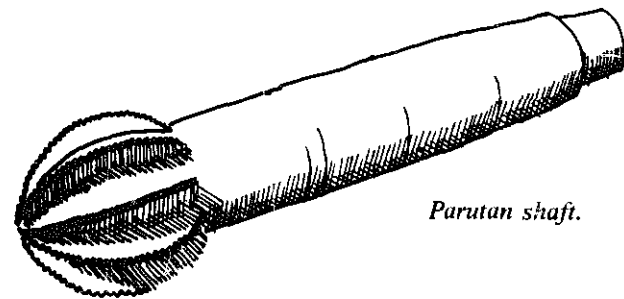

Parutan shaft.

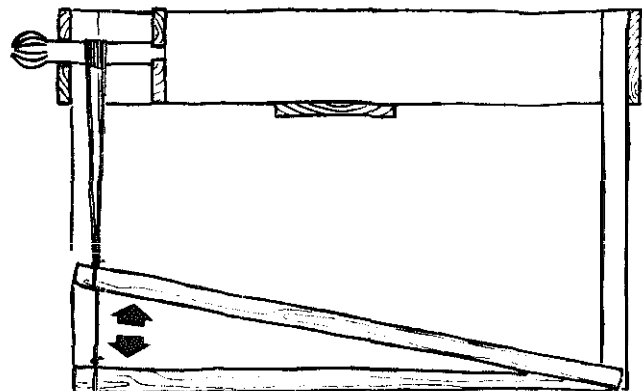

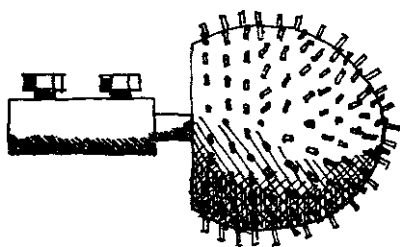
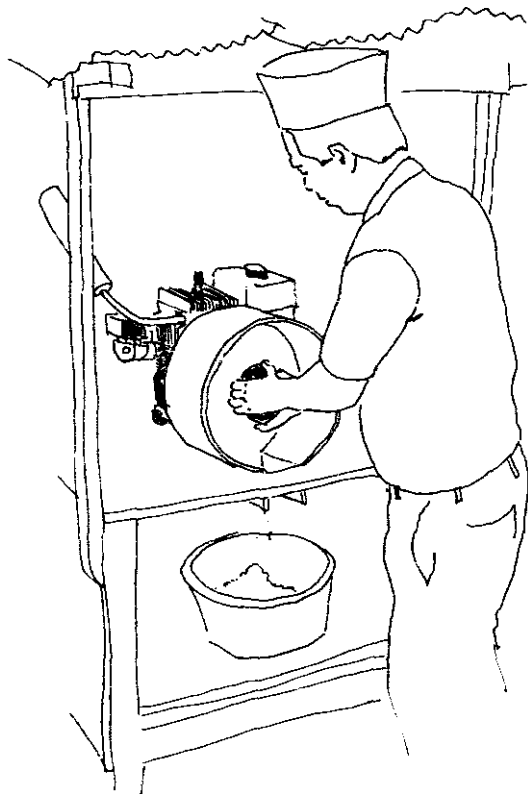

*A very dangerous
motorized coconut grater.*

A motorized *parutan* is used in small oil factories and large markets. A $\frac{1}{4}$ to 1 horsepower gasoline engine turns a coconut grating head which is bolted directly onto the drive-shaft. A circular aluminum guard surrounds the spinning head to catch the grated coconut and funnel it into a container placed below.

Such a tool is very dangerous, and there is no safety guard or emergency clutch to protect the hands of the operator. The people who use this tool claim that it is easy to learn caution.

The grating head differs from the type used on the foot-pedalled *parutan*. Instead of serrated saw-type blades, the hardwood head is covered with steel wire teeth.

Another type of motorized *parutan* uses a rotating iron drum covered with teeth pushed into the metal. The drum is belt-driven. Chunks of coconut meat removed from the shell are forced against the spuming drum. **If** a piece of wood is used to push the chunks against the drum, this tool is safer than the type described above. However, nearly all of the people using this tool push the coconut meat against the sharp teeth with their bare fingers, a very dangerous practice.

Coconut Oil Extraction

There **are** several ways to extract the oil from coconuts. Factories use large mechanical presses to squeeze the oil from chunks of copra. The cost and size of a press strong enough to crush copra makes this method impractical for home or cottage industry use.

The most popular method of producing coconut oil in **Javanese** villages is **called** *krengseng*. Raw coconut meat is shredded, then placed in water and squeezed and mixed by hand. This **mixture** is then boiled until all the water has evaporated, leaving oil and pulp. Straining and **hand** squeezing are used to separate the **oil from the pulp**. *Krengseng*

cooking oil is the type preferred by most villagers. Unfortunately, this method is inefficient, requiring 8 to 10 coconuts to produce a liter of **oil**, and large amounts of **fuel** to boil the pulp and water. The fuel most commonly used is **firewood**, contributing to deforestation and its subsequent problems.

There are other techniques employed by Indonesian villagers, using fermentation and sun-drying. These methods produce more oil per coconut and do not **require** any additional fuel. Some people claim that the oil produced by these methods stinks and has a slightly rotten taste: the people producing and using these

types of oil say it tastes better, and that if the flavor is not desired, there are methods of removing it from the oil after the production process is completed.

The first method described comes from Aceh. Like *krengseng* oil, the coconut is first shredded and mixed with water. The shredded coconut is put into a plastic bucket or other container, then water is added until the coconut is covered. The bucket is left in a cool place for about a week while the coconut ferments.

The coconut meat is then spread on mats or flats and sun dried until most of the water is gone. Depending on the weather, this takes 2 to 5 days. It emits a powerful stench and turns dark brown. To press the oil, the coconut is scooped into a hoop of plaited rattan, shaped like a soccer ball with two pieces sliced off. The Acehnese call this rattan hoop the *klah*.

A banana leaf is placed over the open sides of the *klah*, which is then set on a sheaf from the *pinang* palm tree. The *pinang* sheaf folds in half, around the *klah*. This fits into the press, called an *apit*. The *apit* consists of three



Placing coconut meat in the klah.

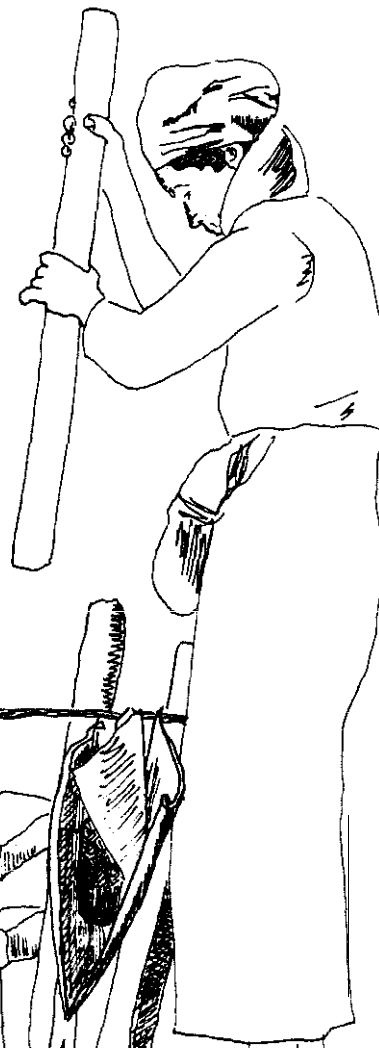

Pounding wooden blocks squeezes out the oil.

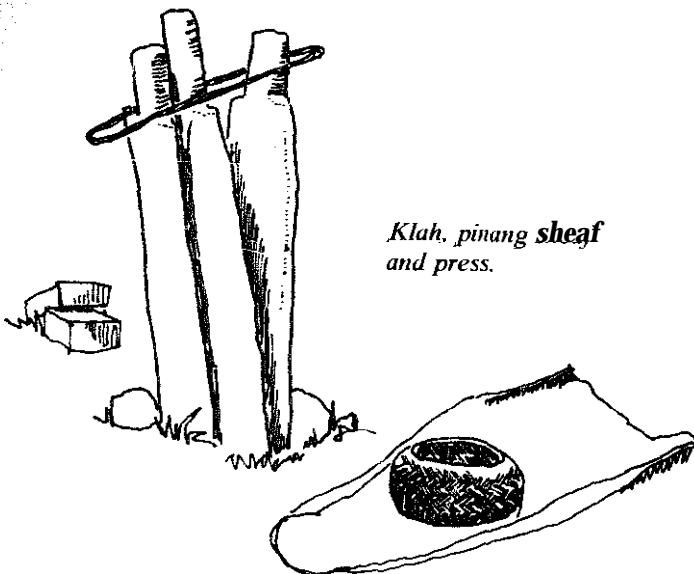

Klah, pinang sheaf and press.

pieces of wood. the outer two planted firmly in the ground with the tops held in position by a loop of heavy iron wire. The third piece can move freely between the outer two.

The kbh with its *pinang* sheaf are fitted into the gap between the center piece and either of the outer pieces of the *apit*. A small wooden block is squeezed into the other side. This block is pounded with a heavy wooden pole until the gap widens enough for a larger block. The use of larger and larger blocks forces the center piece over, squeezing the *klah* until the oil runs out into the bottom of the palm sheaf, which is slanted slightly so that all the oil drops off one side into a container on the ground below.

The first squeezing produces mostly cloudy water, which is thrown away. The coconut is then sun-dried for another day, and squeezed again. The process of sun-drying for a day between squeezing is repeated four or five times, until no more oil is produced. The oil is clear, clean and ready for use.

The Acehnese like to eat the dried pulp, which they call *pliku*. It can be cooked in a soup made of mixed local vegetables, or mixed with different types of juicy fruits and wrapped in a papaya leaf. In Java, occasionally someone mixes the dried pulp with soybeans when making *tempe*. This should never be done! Many people have been poisoned this way.

A similar coconut oil extraction method is used in a few villages in Central Java. Crushed *ketam* or *yuyu* crabs are mixed with the grated coconut meat to start the fermentation. *Ketam* and *yuyu* are small fresh water crabs found in Indonesia's rice paddies, canals and lakes. After the top of the shell is removed, the crab meat is mashed into a paste. One or two crabs per coconut are needed. The mashed crab is mixed with grated coconut, then placed in a covered bowl and left overnight to ferment.

The next morning, the coconut should

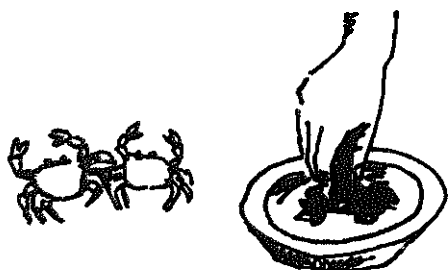

appear reddish and sticky. If it sticks to the fingers when handled, it is ready for drying. As no water was added, it dries quickly.

The coconut is spread thinly and evenly on a mat or metal sheet. It is then set in the sun and left to dry for 2-3 hours on a hot day, longer if the day is overcast. It should be stirred and turned once to assure that it dries evenly.

The coconut turns brown as it dries. Once most of the water has evaporated, the dried pulp is collected in a large bowl, and the oil is squeezed out. This can be done by hand. Then the pulp should be sun-dried for another 2-3



hours, and squeezed again. This will yield about 25% of the amount already obtained. A press like the *apit* described above yields more oil from the coconut than hand squeezing.

For larger amounts of coconuts, the process can be modified. A few coconuts are fermented as described, but then instead of drying them, this fermented coconut is used as starter for a large batch. It is mixed with freshly grated coconut in the ratio of 1 to 5. The remainder of the process is the same. For continuous production, one fifth of the fermented batch is saved each day to mix with the freshly grated coconut the following day.

People who do not like the distinctive flavor and odor of oil produced by fermentation can deodorize the oil. A few slices of red onion are cooked in the oil and then it is strained and stored. Dark green or brown bottles are best for storing oil.

Coconut Oil Press/

Pemeran Minyak Kelapa

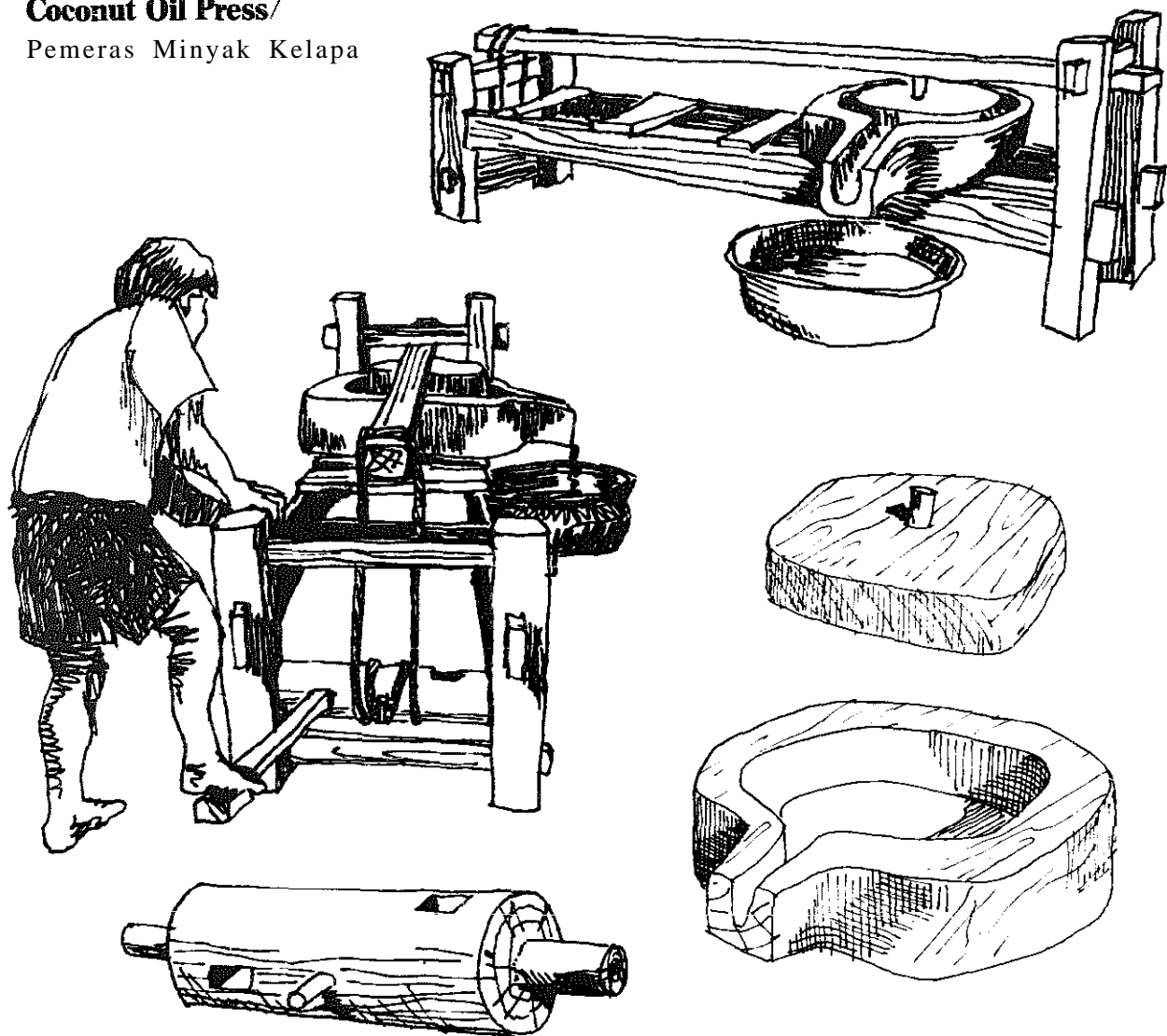

Squeezing **coconut** oil by hand or with a small *apit* and *klah* is fine for making small amounts of **oil**, but if production exceeds the oil of 20 or 30 coconuts per day, these methods become too laborious. A larger press is needed so that one worker can press large amounts of coconuts. One such press, or *pemeran minyak*, is the winch-operated model from Central Java depicted here. This easily made press is used by oil producers to process **up to 250** or 300 coconuts per day.

The press operates by squeezing prepared coconut pulp **between** a flat wooden bowl and a wooden foot, which is pressed down with **great** force by a lever. The lever is pulled down by a rope which winds around a **winch**. The winch is tightened by inserting a wooden pole into slots

cut in the winch drum, then pressing this pole to the floor, taking more rope into the coil around the winch drum and pulling down the lever and the press foot.

Two to four kg of prepared **coconut** pulp is first placed inside a woven plastic gunny sack. **The** sack is set in the bowl and the press foot and lever put in place over the bowl and sack. **The** rope is looped over the peg on the winch drum and the operator begins to winch the lever down. Oil runs out the spout into a **large** bowl or other container placed on the **floor**. As the coconut runs out of oil, the flow from the spout trickles **to a** halt. As with other pressing methods, **the pressed pulp** can be sun-dried and pressed again the following day, yielding a bit more oil.

Sugar Cane Press/Kilang

In recent years a number of "mini sugar factories" have been created. However, a large number of small sugar cane farmers still make their own *gula merah*. They press the juice from the **ripe** cane, boil it all day until it becomes a thick **syrup**, and then pour it into shallow **coconut** shell molds to harden.

The press, called a *kilang*, has two upright wooden cylinders with meshing gears that **turn** uniformly in opposite directions. One roller has a wooden beam connected to it, pulled by a **buffalo** walking in a circle. The rollers are held in place by a **frame** made of four parallel wooden beams which, along with four **cross-pieces**, fit into notches in the rollers. The gap between the rollers is adjusted by driving wooden wedges into the slots which hold the crosspieces, forcing the crosspieces and the rollers closer together.

A large bowl is placed in a hole under the rollers. As the **buffalo walks slowly** around its circle, pieces of cane are fed **between** the rollers **one at a time and the juice is squeezed out**. Each piece of cane is pressed three to four times, **until** nearly all the juice is squeezed out. Many

broken pieces of **cane** also fall into the juice, so it must be strained through a piece of cloth before boiling. (The *kilang* can also be used to press coconut to extract the oil. For this activity, the rollers are spaced further **apart** and the grated coconut is placed in a gunny sack which is passed through the press.)

The shredded pressed cane is set on tacks above the cooking fire to dry, then mixed with sticks and used as fuel for boiling the sugar.

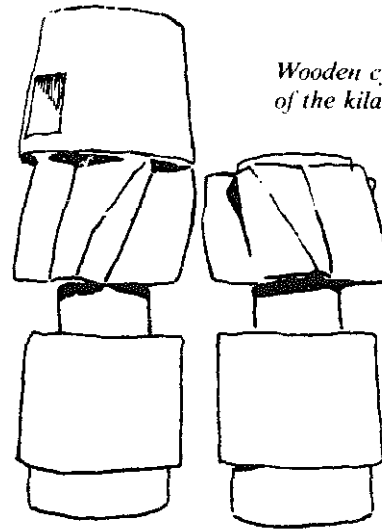

Wooden cylinders of the kilang.

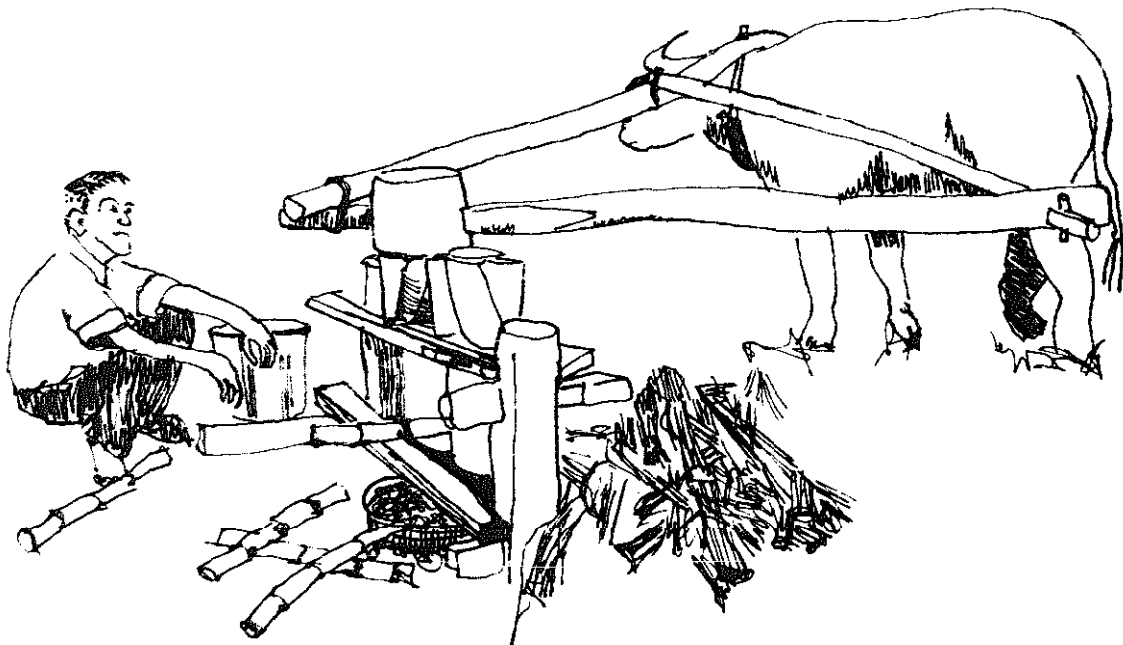

Coffee Pulper/Pengupas Kopi

When coffee is harvested, the beans are surrounded by a tough pulpy fruit. This fruit must be removed to dry the beans. The laborious pulping process can be accomplished in several ways. For small farmers with only a few trees, it is easiest just to pound the beans in a *lesung* (large mottatand pestle), until the fruits are smashed and coming off the beans. Large operations use motorized pulpers. But the majority of Indonesia's coffee farmers do not have enough beans to justify the large capital outlay and operating expenses of such a machine, yet find that pounding the beans is too much work. Many of these farmers use simple hand-cranked pulpers, *pengupas kopi*. Though made in many different shapes and sizes, these pulpers all operate in a similar fashion. The pulper consists of 3 components:

1. The only moving part is a large drum, which is rotated by the operator. Often these drums are made of wood, covered on the outside with strips of sheet metal. The edges of these strips are folded to double their thickness and leave them dull to prevent them from cutting into the green coffee beans. The strips are nailed onto the drum, each overlapping the

strip before it. In this way, a ridged or corrugated surface is formed.

Another way to make the drum is to cut small slits in a sheet of heavy gauge sheet iron. One side of each slit is then pounded out to form a tooth. The iron is then bent into a cylinder of the appropriate size (diameter: 10 to 15 cm). The drum is attached to an iron rod axle, and one end of this axle is bent into a crank.

2. The axle fits through both sides of a sturdy four-legged wooden frame at a height which is comfortable for the operator (about 1.3 meters). The frame should be heavy and strong enough to prevent the machine from wobbling or tipping during use.

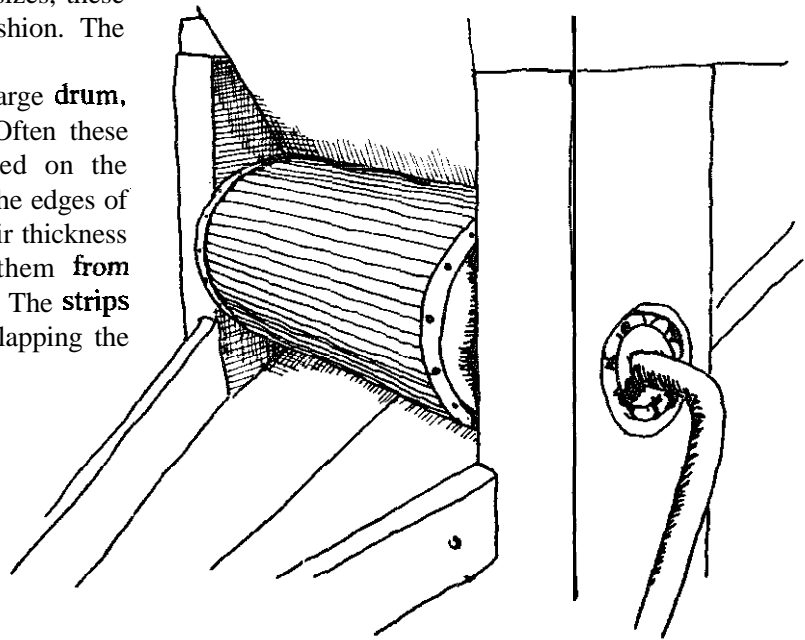

Two drum options for the coffee pulper.

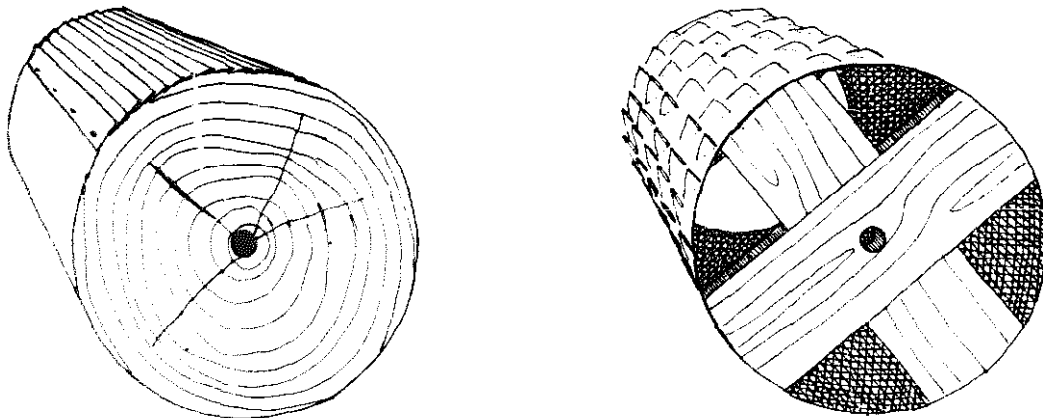

3. A **wooden** chute passes below the drum at a **45-degree** angle. A hopper feeds the whole **beans** onto the chute above the drum. The gap between the drum and the chute is 5 or 6 mm. Some slightly more sophisticated designs allow adjustment of this gap by moving the chute up or down a few **millimeters**.

Freshly picked coffee beans are dumped into the hopper. The **crank** is then turned in the direction which **will** squeeze the beans between the drum and the chute (clockwise in these illustrations). Fresh coffee beans have a diameter of 7 to 12 mm, and the **two** halves of the bean **must** split **apart** to fit through the small gap. As the beans are pulled through, the pulp is torn and crushed. Below the drum, the chute's wooden sides guide the pulped beans into a container placed **on** the **floor**.

The coffee beans are then dried in the sun until the pulps become dry and brittle. Then they are pounded to break the skins off the bean halves. Care must be taken not to break the beans. The beans and chaff are separated by

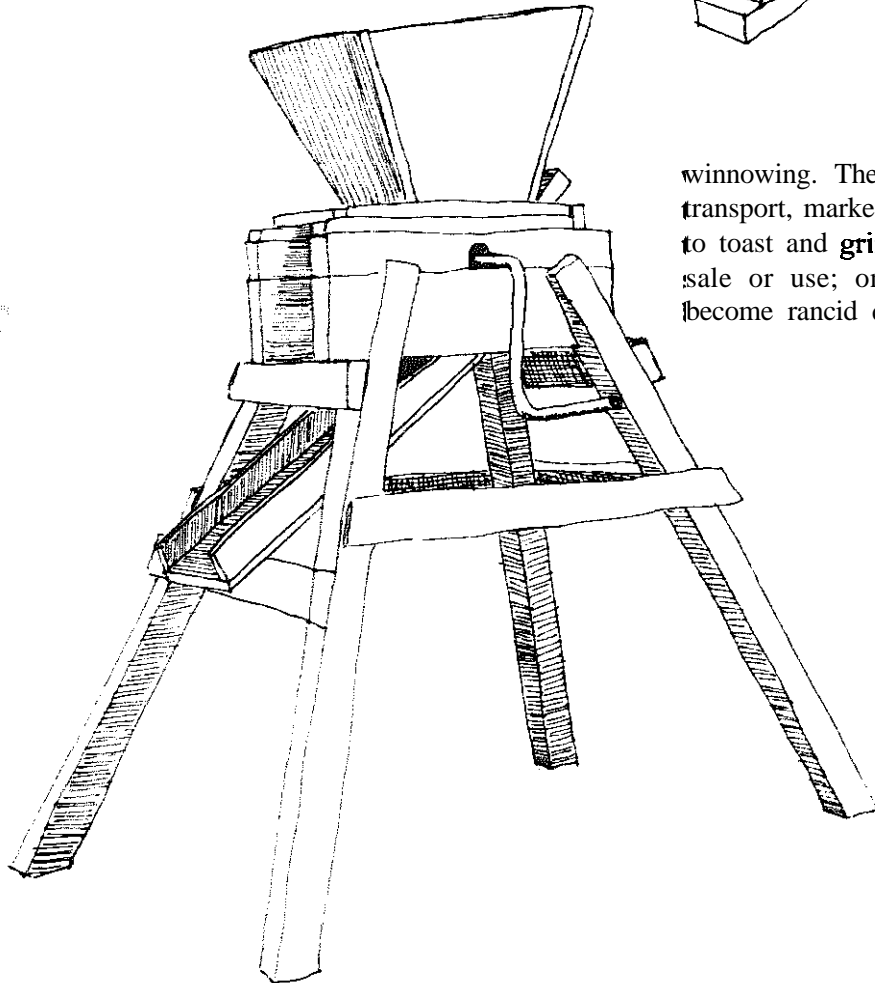
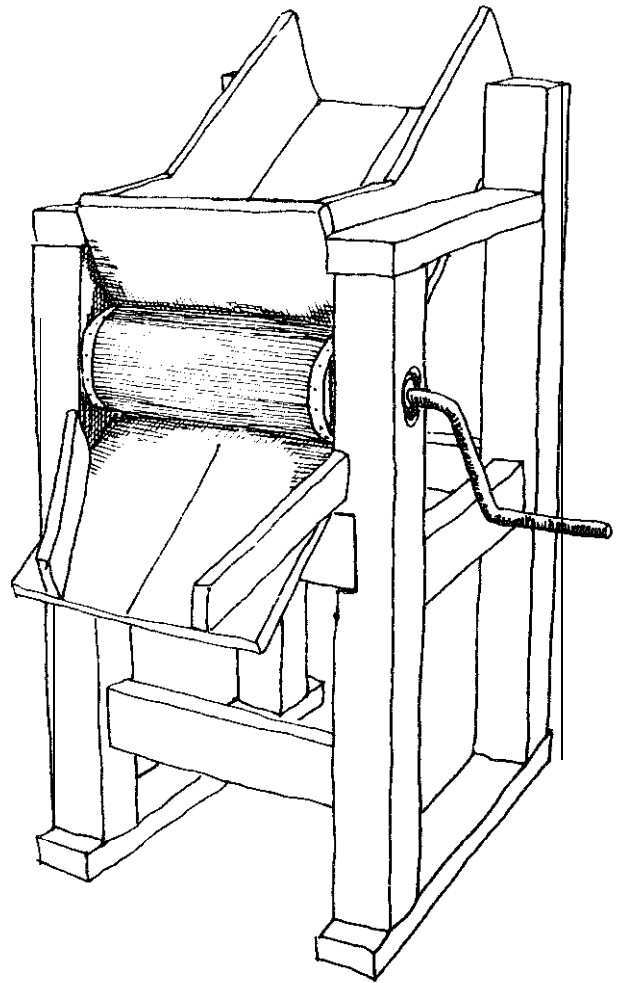

winnowing. The cleaned beans are ready **for** transport, market, storage or toasting. It is best to toast and **grind** the beans only just before sale or use; once toasted the coffee beans become rancid quickly.

Fried Crackers/Krupuk

Krupuk are crisp airy crackers eaten as snacks or taken with meals. *Krupuk* are made from either cassava, rice or sago flour and some fish, shrimp, garlic or onion for flavor. Recipes vary, but the basic ingredients and procedures are the same. *Kanji* powdered cassava starch, rice flour, or dried sago starch (from sago palms in Eastern Indonesia) is mixed with enough hot water to form a thick paste. *Terasi*, made from aged mashed fish or shrimp, or freshly mashed fish or shrimp are added to the mixture, about one part to ten of *kanji*. Sometimes mashed garlic or onions is added along with, or in place of the fish or shrimp. Salt is added, about one quarter to one half as much salt as fish or other flavoring agents, and the dough is kneaded until uniform.

The dough is shaped into thick cylinders which are wrapped in banana leaves to be cooked in steam trays over boiling water for one or two hours. The still wrapped cylinders are cut into thin round slices. Some Central Javanese *kmpuk* manufacturers use a clever slicer with a hinged cutter whose blade has a spacer gap so that all the slices are uniformly thick, about 2 to 3 mm.

The slices are then set on trays to dry in the sun, usually one day if the sun shines, longer during the rainy season. The dried *kmpuk* can then be packaged for sale to people who fry their own *kmpuk* at home, or fried and packaged for sale as snacks. Unfried *krupuk* can be stored for long periods, but once cooked it must be eaten quickly as it soon loses its crispness.

Krupuk is usually fried in hot oil. When dropped into the oil, it quickly expands to a light cracker about four times the size of the uncooked chip. Sometimes the snack variety is cooked in big pans full of hot coarse sand. The sand can be shaken free from the cooked *kmpuk*.

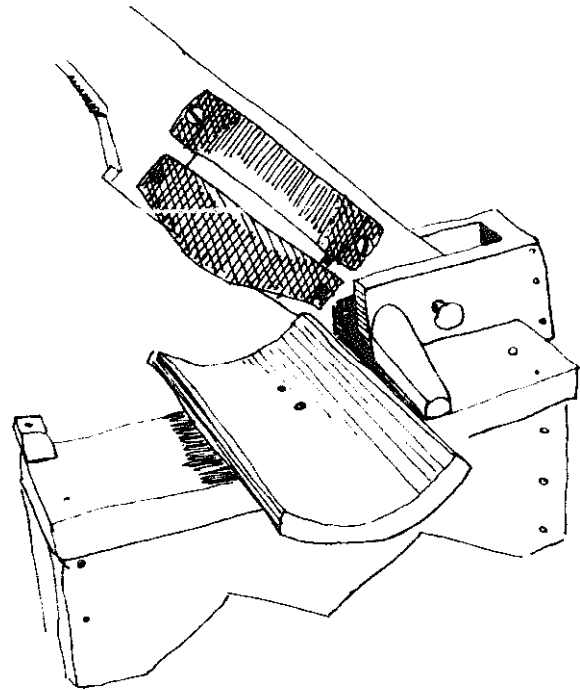
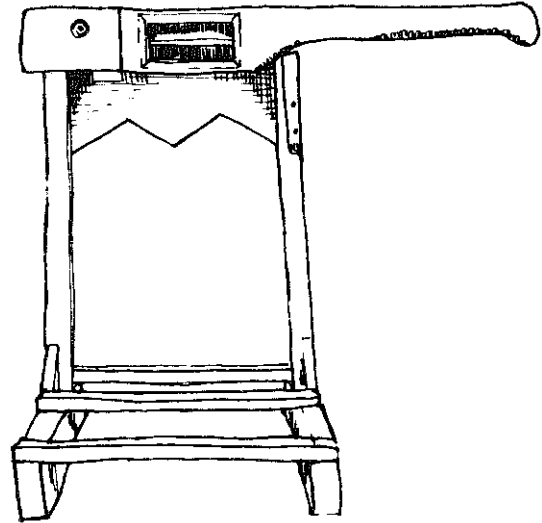

Krupuk slicer.

Banana Ripening/Pisang

Bananas must be picked while still green so they can be transported and stored. After picking, the bananas continue to slowly ripen until they are sweet and yellow. There are ways of speeding up this ripening, which is important for people **selling** bananas; they must have large amounts of uniformly ripe fruit. The most common method is placing the bananas in a closed container which is **flooded** with carbide gas. In a short time this gas turns the bananas bright yellow and causes the flesh to ripen. **Bananas** prepared in this fashion are attractive and uniform, but the flesh is often harder and not as sweet as naturally ripened bananas.

A traditional method in Bali produces sweeter bananas. The bananas are hung inside an empty oil drum or large clay pot. The top is closed with another clay bowl, the seam sealed with ash and water paste. On top of this bowl is placed a small perforated bucket **filled** with rice husks ignited to **smolder** slowly. This bucket is refilled **with** fresh husks as they burn down. The low heat thus produced accelerates the natural ripening of the bananas and after about three days, the fruit is ready for sale or consumption.

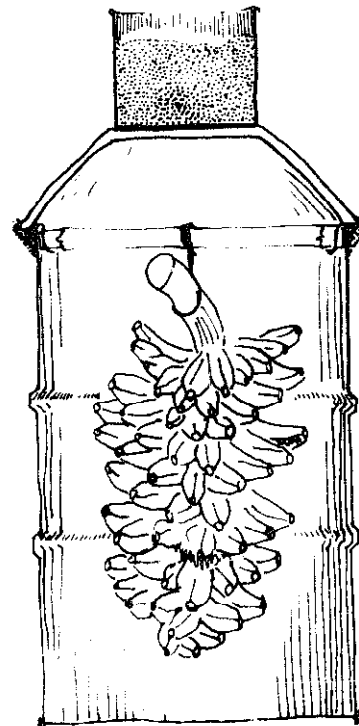
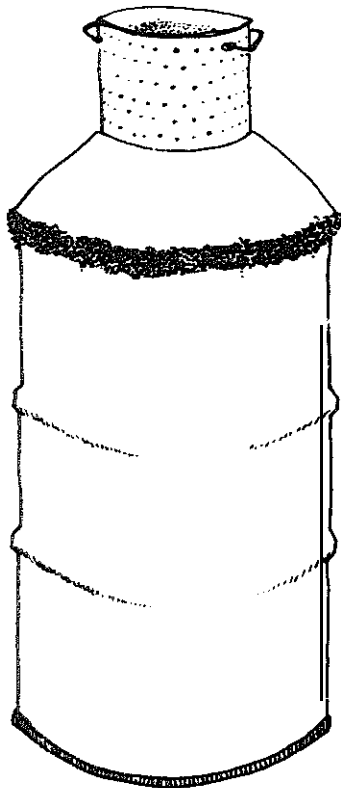

Cooking Stoves/Tungku

For the past several years, the price of kerosene has been subsidized by the Indonesian government to encourage its use as a cooking fuel and reduce the strain on the forests of Java and other heavily populated areas. But most people still use wood and agricultural wastes such as corn stalks and rice husks for their cooking needs.

Some traditional wood and trash burning stoves are well designed for very small cooking fires. They confine the fire and its convective heat to the area under the pot, resulting in increased efficiency compared to the pot-on-three-stones systems still used in a few areas.

The *tungku* are hand made from sandy clay. They come in a variety of sizes, from those for use by small families up to larger models for use in busy food stands. Some have two or three holes, providing equal heat if arranged side by side. The pot stands hold the cookpots on three or more humps built into the stove top, allowing the fire and heated air to pass up around the base of the pot.

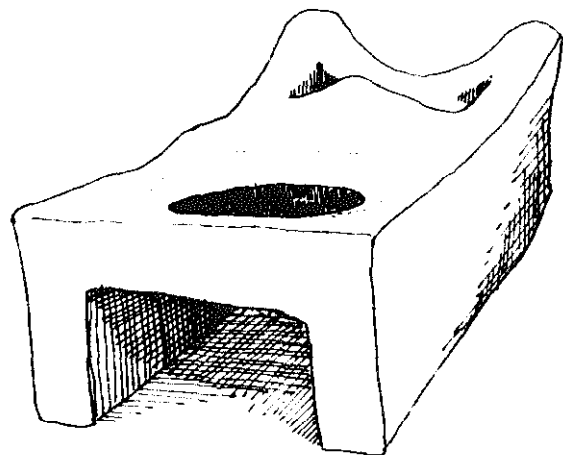
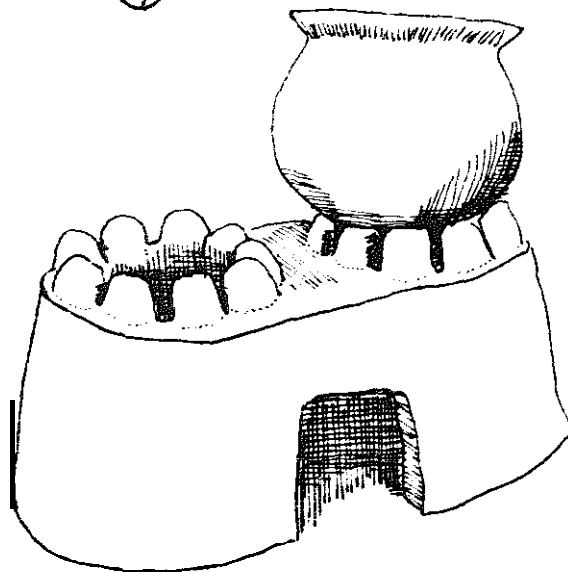
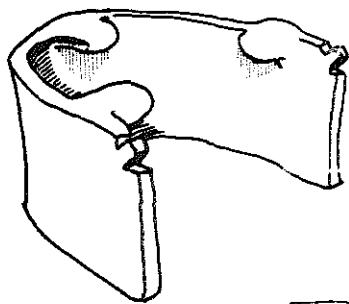
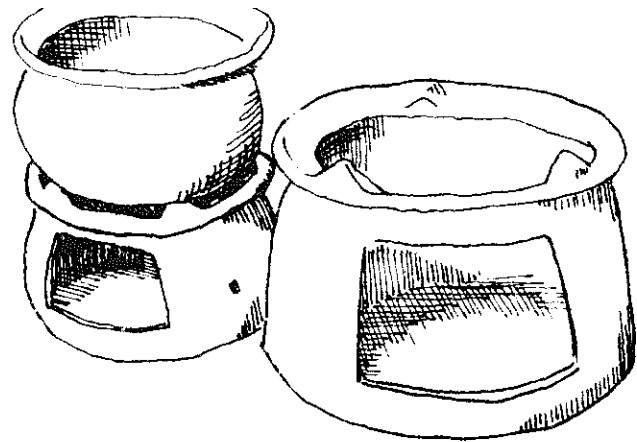
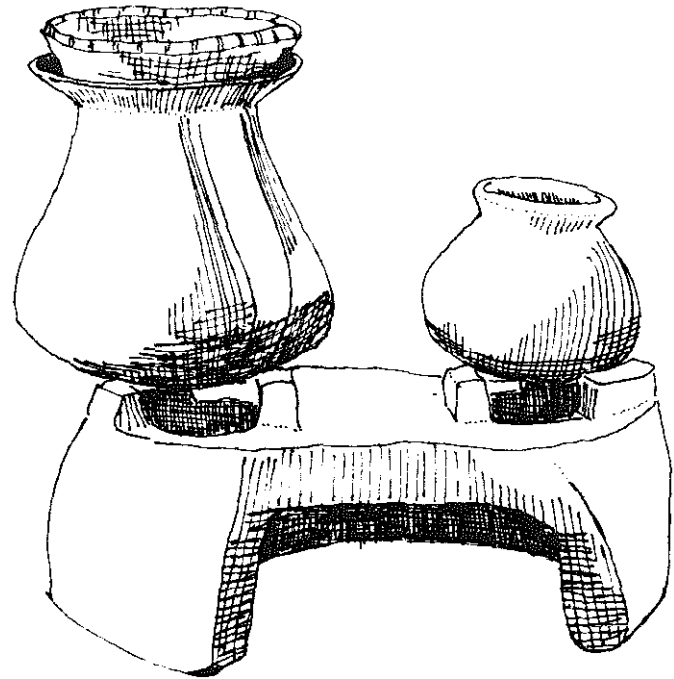

In areas where people have wooden floors, on boats or in houses built on stilts, stoves are designed to hold the tire up in a container set off the floor. These stoves usually include a space in the front for coals and sticks which protrude out the front of the tire, being pushed in as they are consumed.

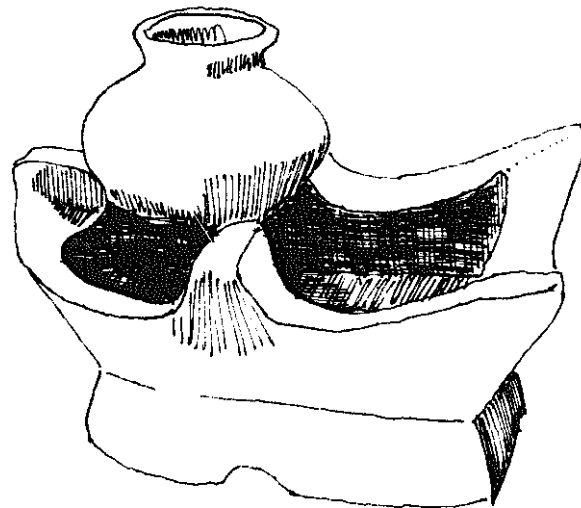
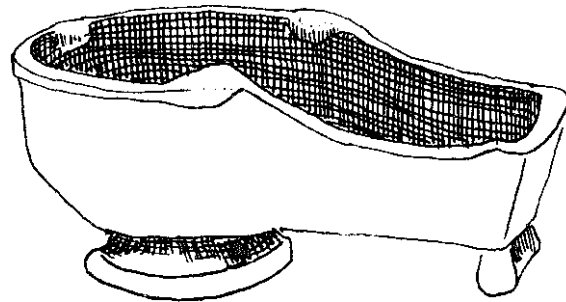
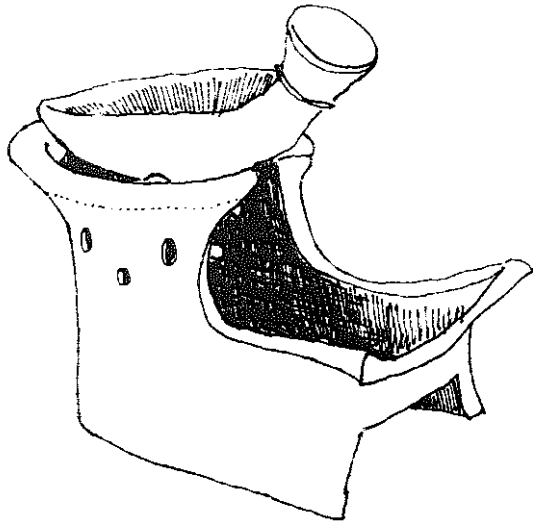

Many **Javanese** prefer cooking with charcoal. The *anglo* is the most common type of charcoal stove. The perforated bowl-shaped tray on the top of the stove holds the pot with the burning charcoal just underneath it. The tire is fanned with a flat plaited bamboo *kipas* through the hole in the base of the stove, which also serves as an ash trap.

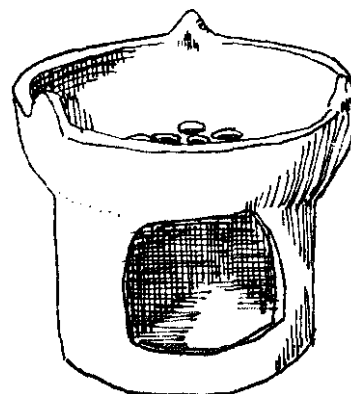

Rice Husk Stoves/Tungku Sekam

Rice husks, often regarded as a nuisance by rice millers, can be used as a cooking fuel. Burning unaided, the husks **smoulder** slowly, not producing enough heat for cooking needs. There are a variety of different rice husk stoves (*tungku sekam*) which employ one of two methods to burn the husks for sufficient cooking heat.

The first type of *tungku* requires the addition of small amounts of **wood**, bamboo or trash to assist the combustion of the husks. These *tungku* are square or dome-shaped chambers with one or more small doors at the base and a hole to hold a single **cookpot** at the top. The three-borne: **stove** shown here is actually three separate *tungku* built together, which can be fired up individually or simultaneously.

The *tungku* are filled with tightly packed husks, with a channel leading from the door to the center then straight up to the top of the stove. Once they are lit, they continue to burn until all of **the fuel** is consumed, a period of one to three hours, depending on the size of the *tungku*.

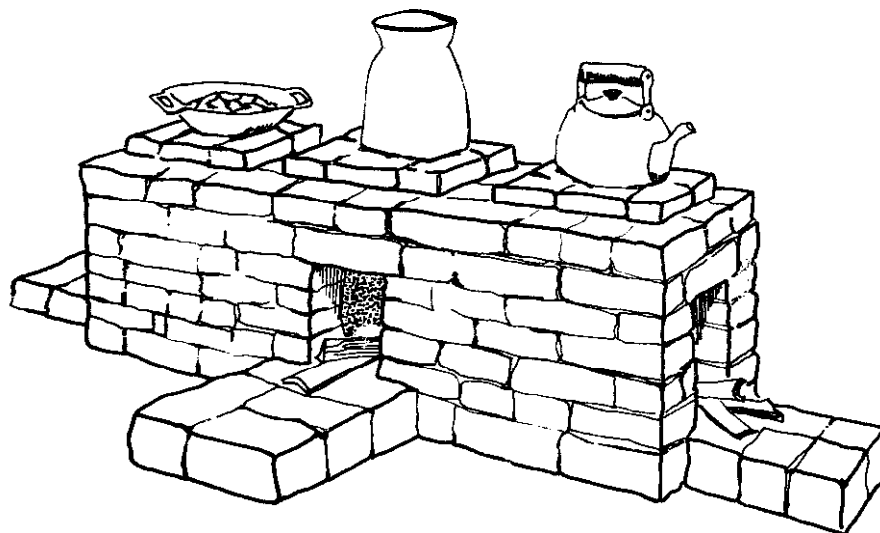
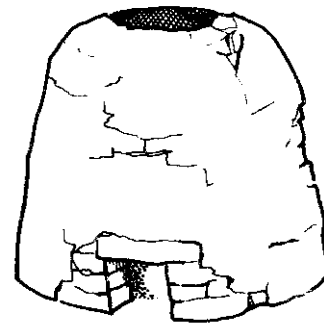
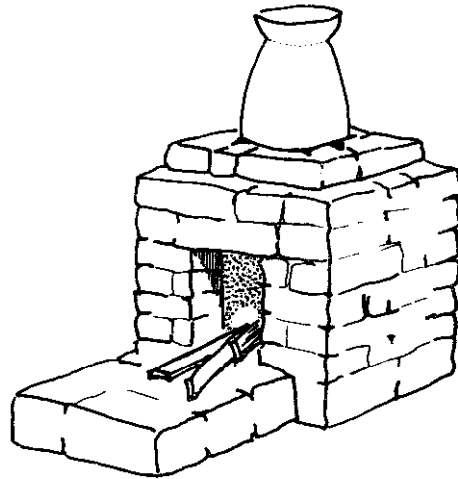

The stoves are filled by first placing a round piece of wood vertically in the center of the *tungku*, and another in through the door, so that they meet at a right angle. Rice husks are poured into the *tungku* and tightly packed by tamping them with another piece of wood or bamboo. The cleanly split husks from mini huller machines do not pack as well as the broken husks from pounded rice, but this can be remedied by the addition of a small amount of rice polishings or by dampening the husks. Husks are poured in and tamped until the *tungku* is full and then the wooden pieces are carefully pulled out, leaving an empty channel

in their place. A small fire is made with wood, bamboo or trash in the bottom opening. The husks ignite and slowly burn. Temperature is controlled by the addition or subtraction of fuel from the control fire; the stove can blaze fiercely with only a small fire in the bottom opening, or if the supplementary fuel is extracted, the fire slowly smoulders. The messy loading process and large amounts of powdery ash produced are the major disadvantages of this type of stove.

*Packing and lighting
a rice husk stove.*

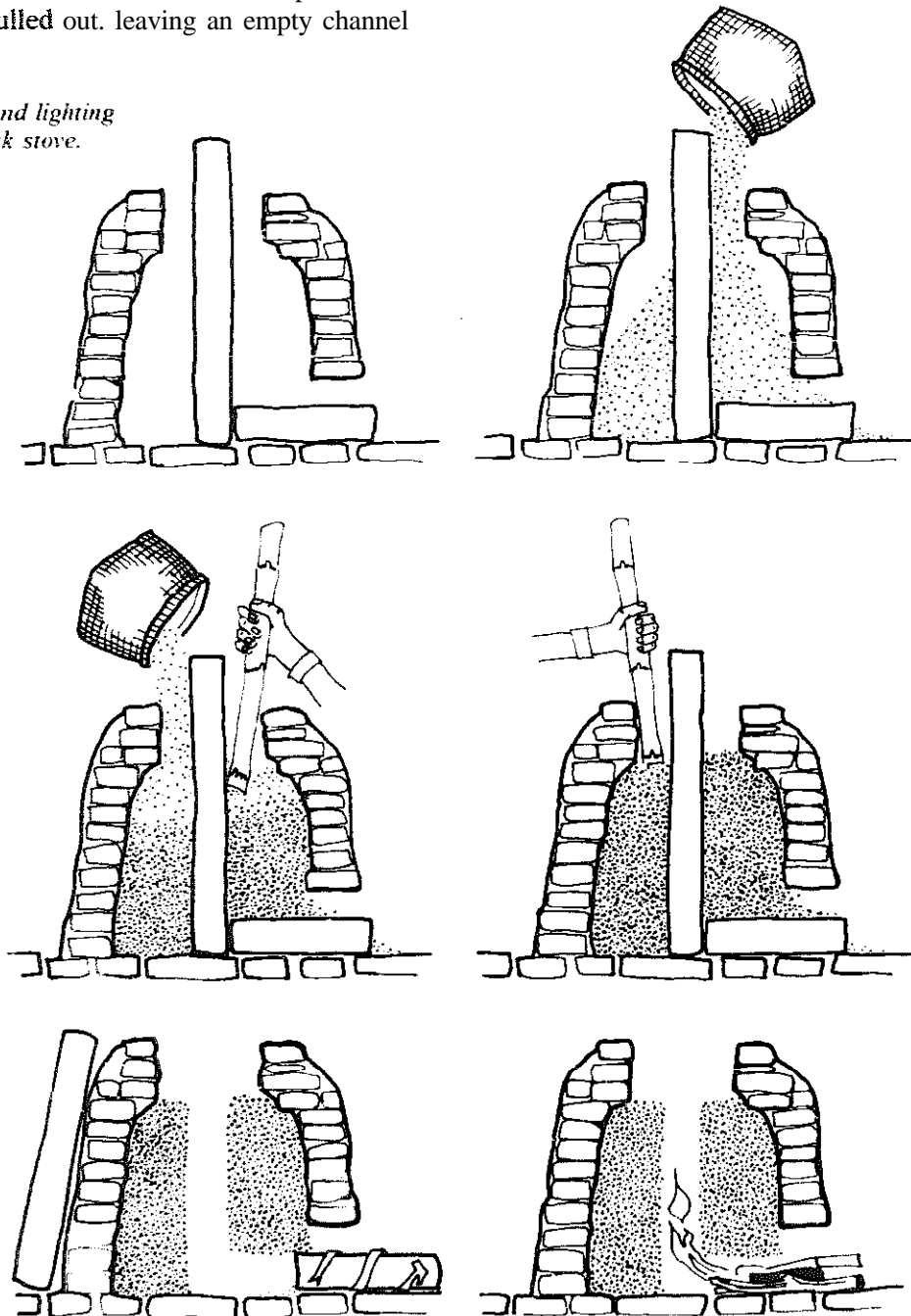

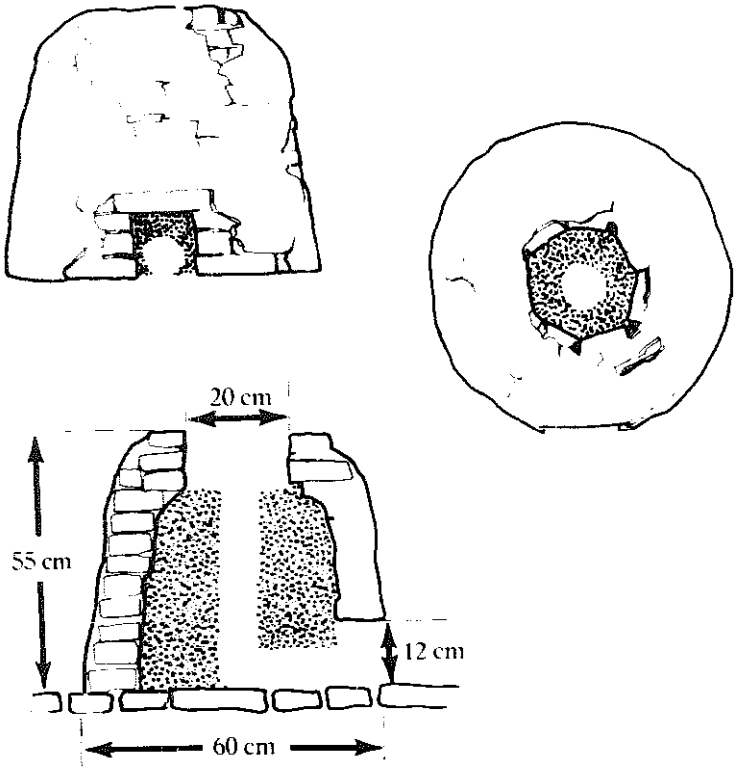

Various views of dome-shaped and cubical 1-burner rice husk stoves.

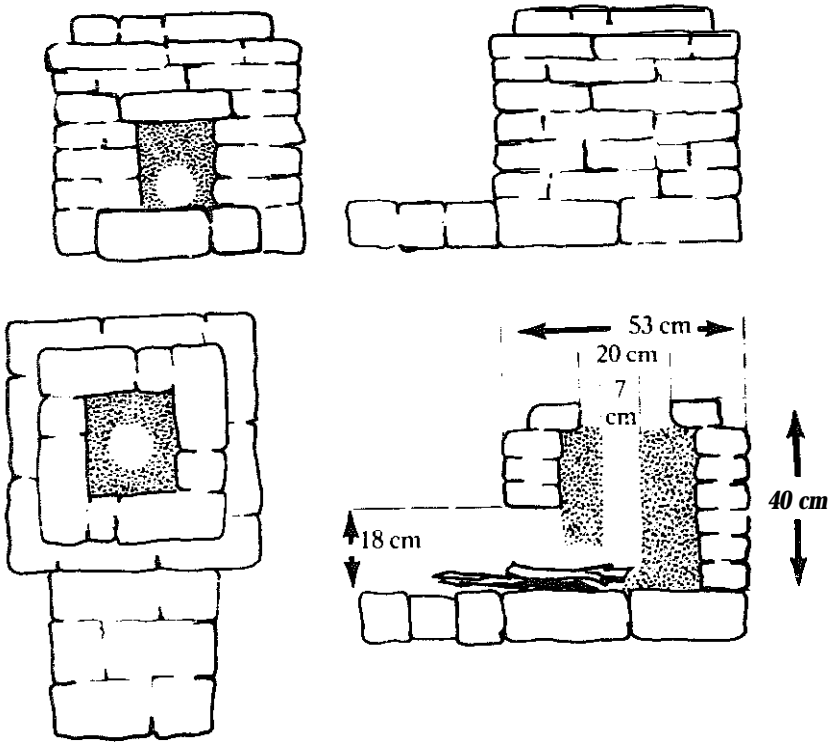

Another more efficient type of stove employs a chimney to create a strong draft to burn the husks. Seldom used in kitchens, these *tungku* are usually found in cottage factories producing *krupuk*, palm sugar or *tahu*. In order to function properly, the stoves must be airtight, so the cookpots are usually built right into the tops of the stoves.

These *tungku* have a fuel hopper over the fire, from which the husks drop down onto a grate to burn. The smoke and hot air from the fire go up the chimney, drawing fresh air in through the grate located in the firebox mouth, to the flames.

A simple three-burner stove is used by producers of *gula Jawa* coconut sugar in East Java. The pots can be removed from this stove. When they are set in place, the gaps around them are sealed with ash and mud paste. The grate is a sheet of perforated iron and the small fuel hopper is made from a bent piece of asphalt drum. The floor of the stove air passage slants upward towards the two meter chimney to improve the draft and narrow the channel in the rear.

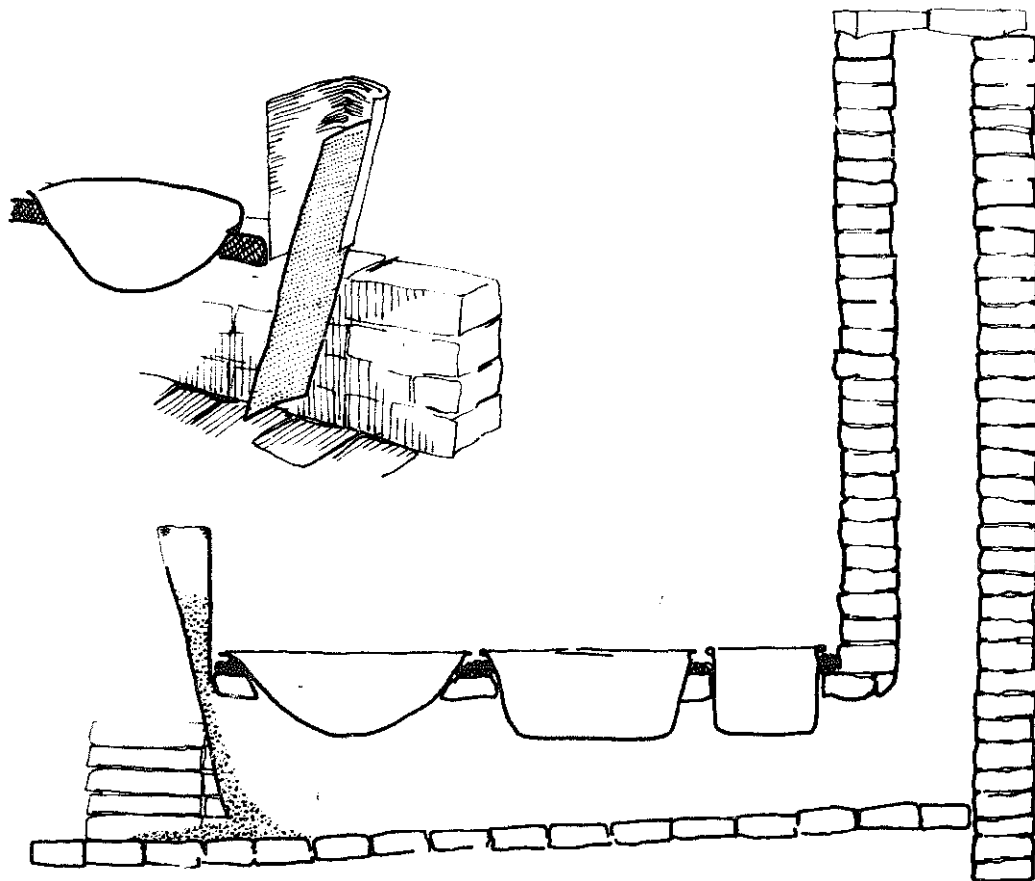
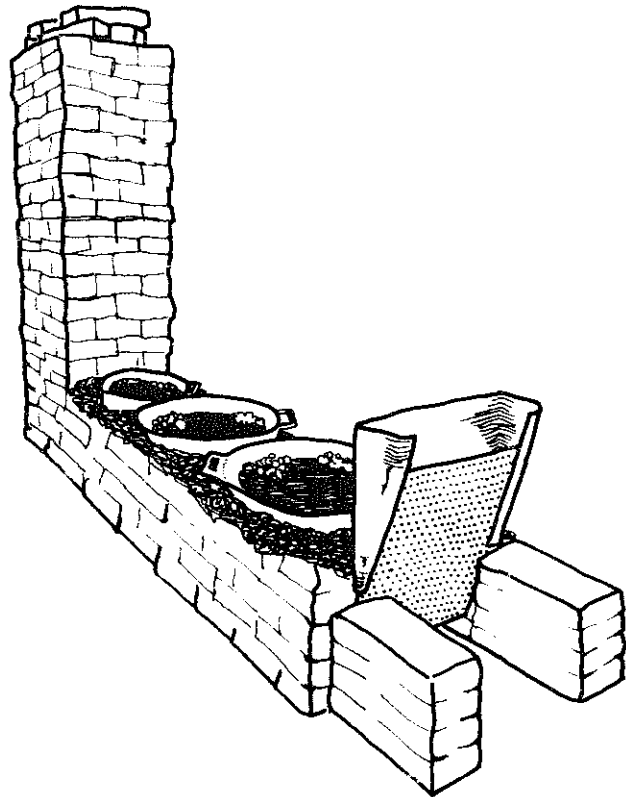

The most common type of rice hull stove is the one used to boil soybean milk in the manufacture of *tahu*. The stove depicted here can boil six to ten 150-liter batches per day, using up about 125 kg of rice husks.

The stove is made of masonry: fired bricks with plain cement-sand mortar. The large round cast iron pot is cemented into the top of the stove. The slanted strap iron grate employed in this stove bums the husks more efficiently than the previous example, but is more expensive and difficult to replace when it wears out after three to five years of constant use. The 5 cm wide iron strips are arranged descending at an angle of about 60 degrees, with 4 or 5 cm spaces between them.

The husks fall onto the grate from the hopper, covering the entire grate with a layer of husks about 5 cm thick. Since the bottom is usually plugged with a pile of ashes, the air is drawn through these husks on the grate. The resulting fire is a roaring yellow blaze. The masonry-and-clay-pipe chimney has an inside diameter of 20 cm and must be at least three or four meters tall in order to create a strong enough draft for the fire. The firebox mouth is 45 cm wide by 60 cm tall.

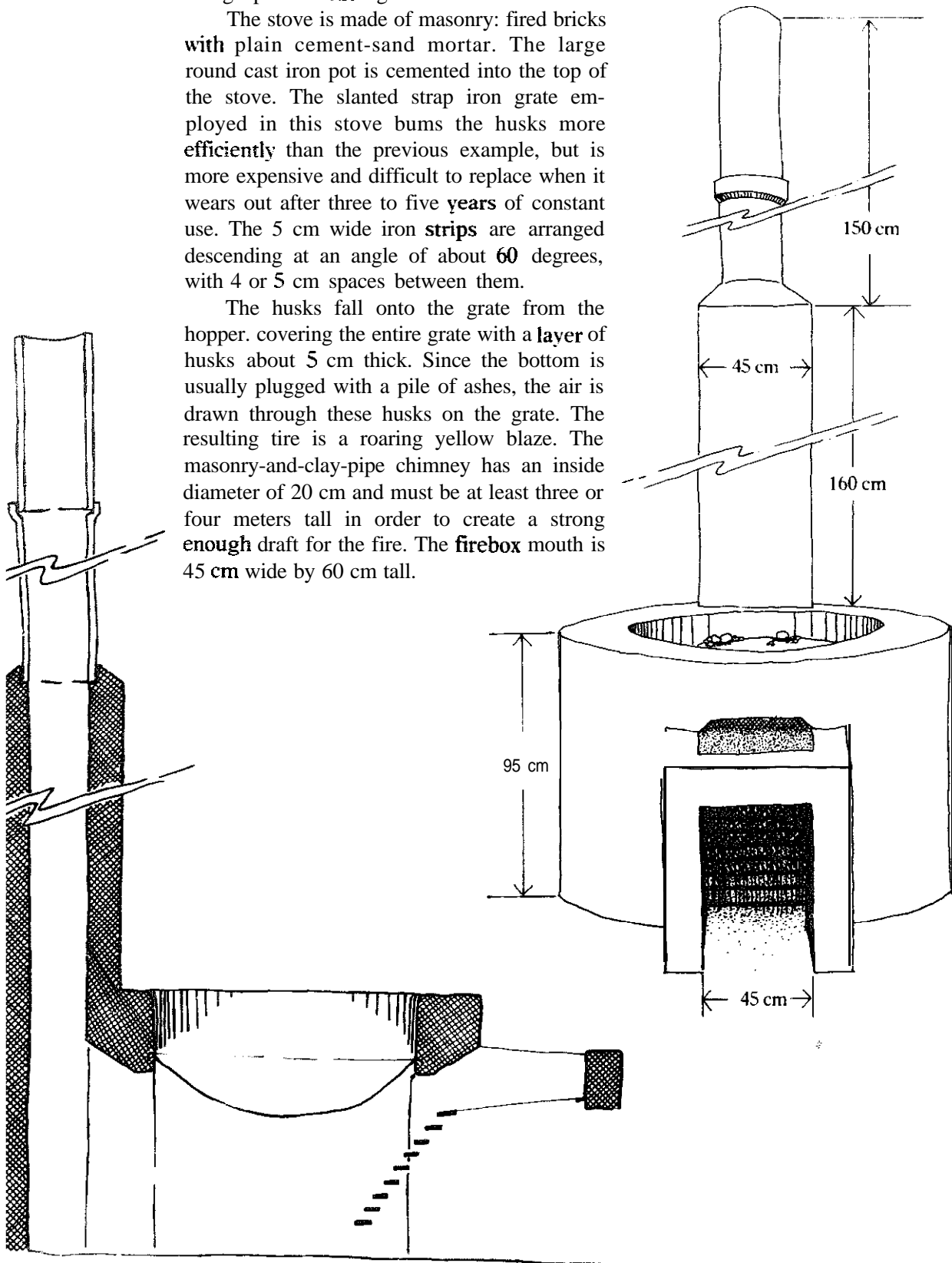

The largest rice hull stoves found in Indonesia are those used to boil water for steaming *krupuk* in some large Javanese *krupuk* factories. Four vats of water are kept boiling in stoves which consume a truckload of husks every four or five days. The smoke stacks are up to seven or eight meters tall. Storing large amounts of this bulky fuel is a nuisance, but the savings in fuel costs make it worthwhile.

The grate configuration is identical to that of the *tahu* stove above, only Large. The floor of the air passageway in the stove slants upward toward the stack end, and the base of each kettle is slightly lower than the one in front of it,

narrowing the passage towards the rear of the stove and providing a more even distribution of heat. Still, the rear two kettles are smaller than the front two and they do not get as much heat.

Racks of steam trays are stacked over the boiling water and large cylindrical sheet metal covers are lowered over them from pulleys in the ceiling above. The *tungku* has a loud roar and covers the surrounding neighborhood with a fine coat of white ash.

More information on rice hull stoves is available in *Rice Husks as a Fuel* by Craig Thorburn, 1982 (available from P.T. Tekton Press, Jl. Merapi 3. Jakarta, Indonesia).

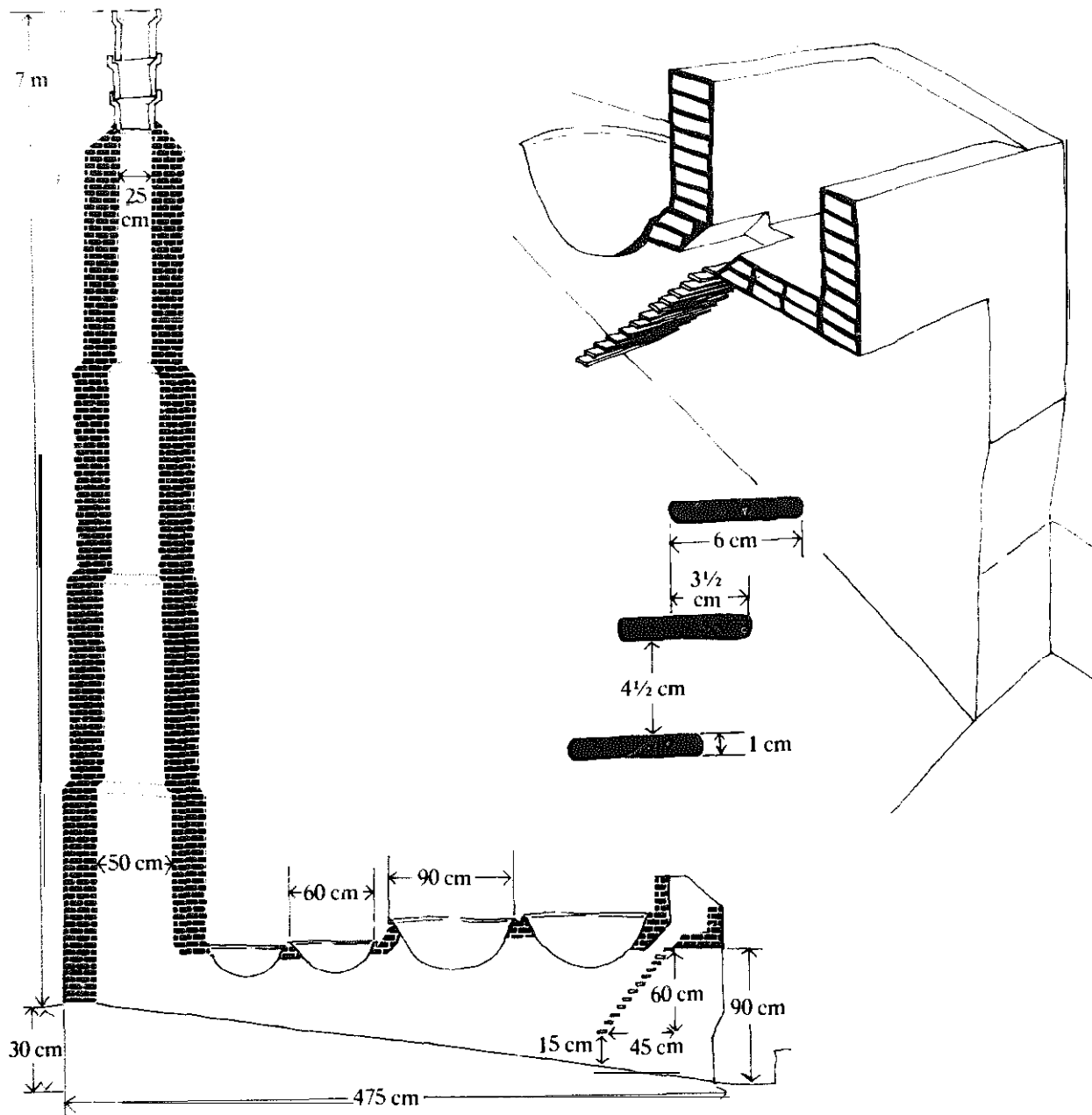

Kitchen Utensils/Ferkakas Dapur

Indonesia boasts a tremendous variety of traditional cooking implements. A catalogue of all the different types and designs would end up being a work larger than this entire book. But a few of the most common types are similar throughout the islands. These simple utilitarian tools have an elegant beauty and are often collected for their decorative value by people from modern industrial nations.

A few of the most common tools are: wooden or bamboo spatulas or flat spoons called *entong*. Shallow spoons made from sections of coconut shell with long bamboo handles are called *irus*, while deeper scoops with the same construction are called *senggotan* or *timba*. Large scoops for dipping fried foods from the hot oil are called *serok*. The traditional design is made from a piece of bamboo, one end split into fine strips and plaited; now most *serok* are shallow cones of sheet metal with many small perforations. No Indonesian kitchen is complete without a *lemper* or *cowek*, the shallow stone mortar and pestle for mashing chili peppers and other spices. The masher is made either from soft wood or from the same basaltic stone as the bowl.

The *tenong* steam tray is a less common tool, mostly used by producers and vendors of small snacks which are cooked with steam. The round trays with slotted bottoms can be stacked several layers high, the base of one fitting snugly over the lip of the next, then placed on top of a boiling pot of water. The traditional *tenong* is made from bamboo; it is being replaced by sheet metal *tenong* of similar design and size.

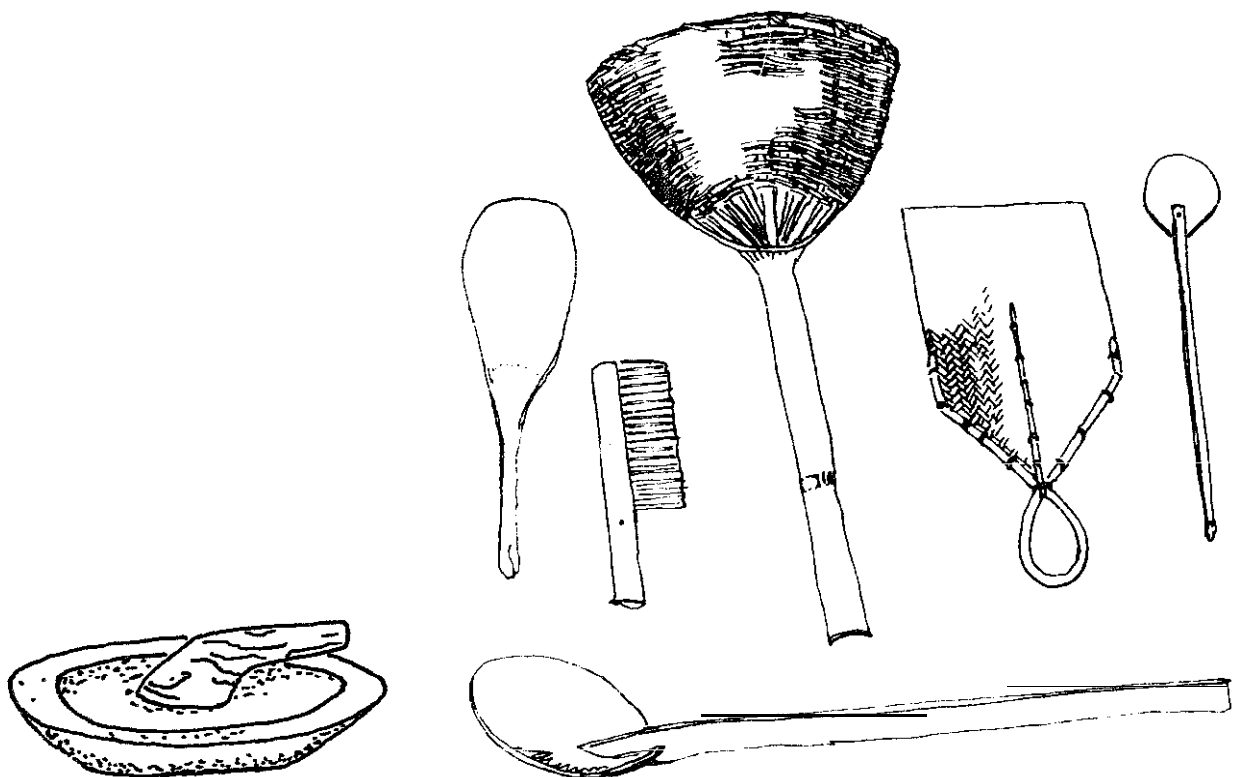
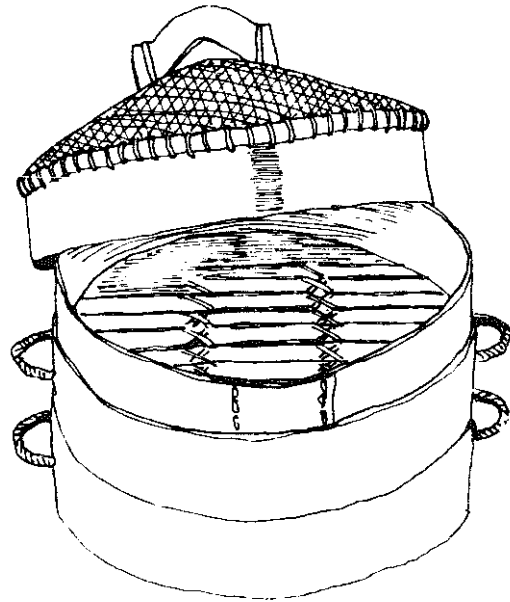

Water Supply/Pengelolaan Air

A good supply of clean drinking water is absolutely vital for survival. Although Indonesia is a tropical country with high rainfall over **most** of the land, during the dry season the wells and streams dry up in **many** areas, and **finding** enough water becomes an arduous and time-consuming task.

Surprisingly, Indonesian **villagers generally** show a lack of ingenuity in dealing **with** this absolutely vital concern. **In** an area of Central Java known for its dryness and **extreme** poverty, a development organization undertook an ambitious program to assist the local population in constructing hundreds of **ferro-cement** and bamboo reinforced cement rainwater catchment tanks to catch and store the water running off roofs during the rainy season for use later in the dry **season** when the wells and ponds went dry. Conditions are normally so bad in this area that in the last months of the dry season water has to be brought in in trucks for those villagers **who** have not **left** for the cities in search of water and jobs. **But** after the tanks were built, most **people** began using the water stored in the tanks during the rainy season and early in the dry season, because it was more **convenient** than going to a pond or well. So by the time the ponds and wells began drying up, the **catchment** tanks were already dry, too.

The **closely** related issue of sanitation and waste disposal is made very **difficult**, and also very urgent, by the increasingly dense population. Most Indonesians boil their drinking water, (**although** not for the 20 minutes recommended by health experts), which indicates a general **understanding** of the germ theory of **contagious diseases**. **However, in the waterways** practically no effort is made to segregate washing areas and water supply areas **from** areas used for defecating. Typhoid and cholera outbreaks are **common**.

Water Filters/Saringan Air

Clean drinking water is a basic need shared by all people. Even in tropical zones with plentiful rainfall, a source of clean water can be a problem. In Bali, the sandstone *batu para* commonly used for sculptures and building construction can also be used to filter drinking water.

Sandstone filters remove sediment, some color, taste and smell. They are especially useful for obtaining drinking water from small streams and irrigation ditches, or for removing sediment and color from rainwater collected off the grass roofs of Balinese houses. Two examples are shown below:

1. Bowl filter for use in streams and irrigation ditches:

Dense, evenly textured sandstone, such as is used for sculptures and building decorations,

can be carved into almost any shape. A simple deep cylindrical bowl makes a fine water filter. The bowl is set in a stream or irrigation canal, with its upper lip placed above the high water line. Water seeps through the stone into the bowl, leaving its contaminants in the outer layer of the stone. Clean water is scooped from the bowl with a long-handled *timba*.

2. Rainwater catchment tank with filter and gravity supply system:

The durable, attractive grass thatch roofs traditionally used on Balinese houses have one major drawback: they collect dust which dirties the rainwater falling on the roof, and the dry grass can impart an unpleasant color and taste to the water. These problems can be solved by filtration. One Balinese home in Ubud has a clever filter installed in the center of its large rainwater catchment tank. Water is drawn from the filter into a gravity feed system which supplies the kitchen and bath. Sandstone

Sandstone bowl filter.

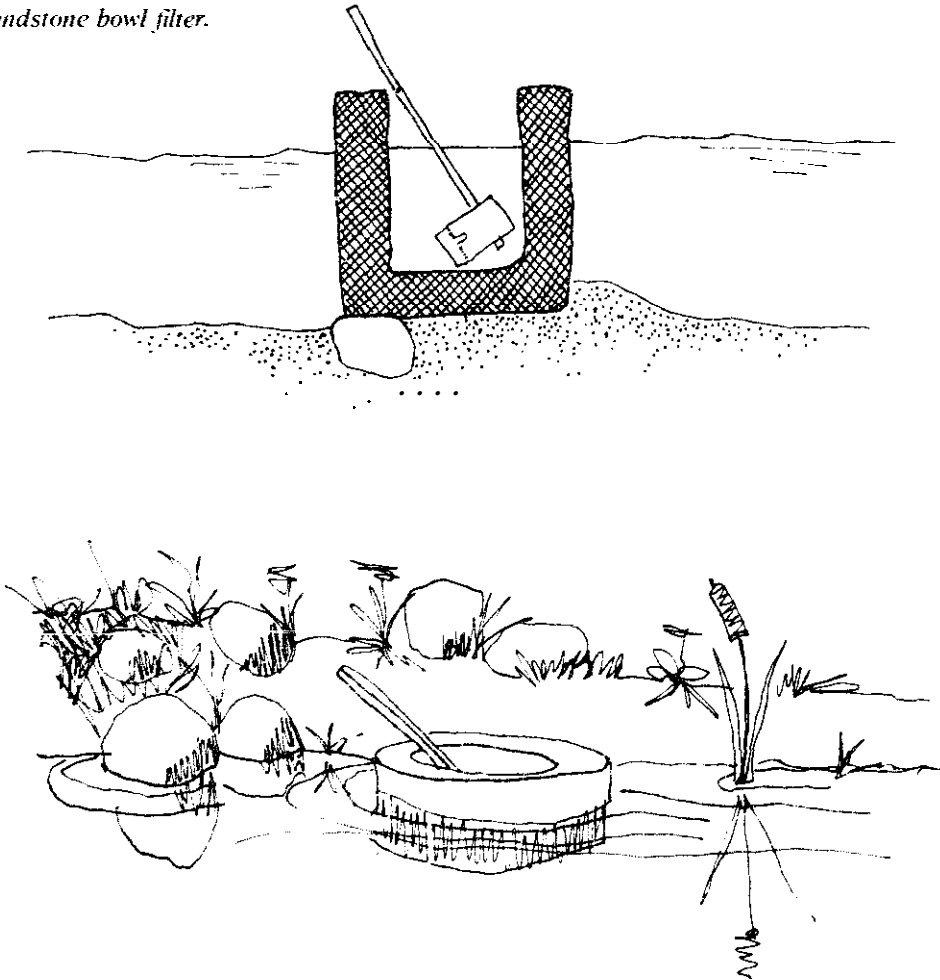

blocks, a common **construction** material in Bali, are cemented into a hollow cube located in the center of the large masonry catchment tank. The top of this cube extends above the high water line of the tank, and is covered with removable stone blocks. Water seeps through the stone blocks whenever the water level inside **the filter cube falls** below that of the diiy water in the outside part of the tank. A galvanized iron pipe pierces the side of the tank and extends through the side of the filter cube, drawing clean filtered **water** for use for cooking and bathing.

The outside **surface** of the stone filters will

slowly clog with accumulated silt and other contaminants. Occasionally, this surface must be scrubbed with a stiff brush to assure that plenty of **water** can flow through the stone into the inside of the filter. If possible, the **filter** should occasionally be dried in the sun to

Water drawn from a sandstone filter may still contain dangerous bacteria and must be boiled before drinking. Fortunately, almost **all** Indonesians do boil their drinking water to make tea, and therefore educational efforts in this field only need assure that they boil the water long enough the **destroy** any dangerous bacteria.

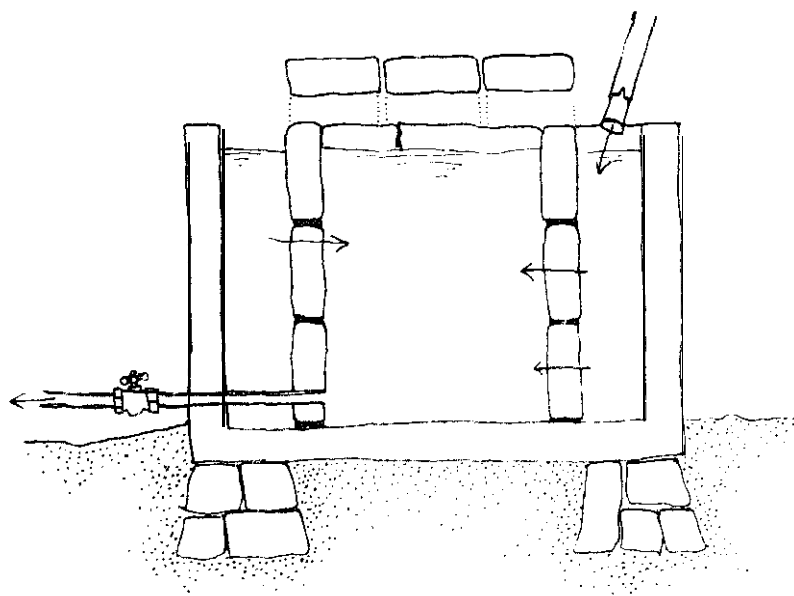
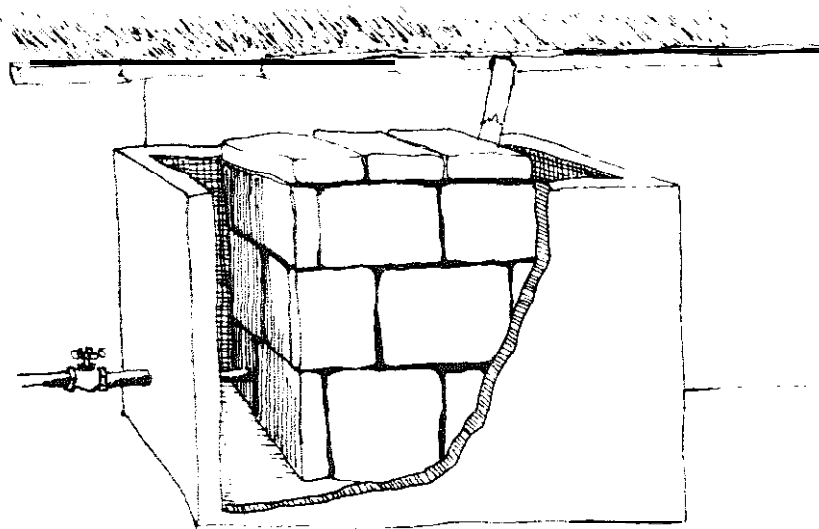

Bamboo Wand Pump/Pompa Bambu

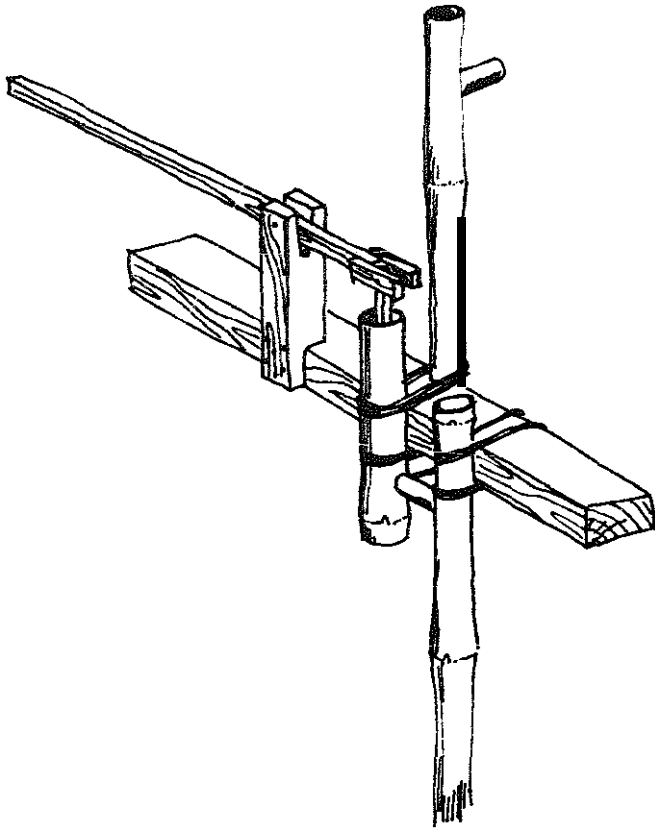

The use of a handpump to raise water from wells has several advantages over buckets or other methods: it is easier and faster, and the wells remain cleaner because dirt from the top and sides of the well does not get knocked into the water. In fact, wells can and should be covered if a pump is used. Most rural Indonesians recognize the advantages of using pumps to draw their drinking water, but the high cost of cast iron "Dragon" pumps prevents most villagers from owning them. However, in West Java a village craftsman has created a handpump made entirely of materials available in villages; large bamboo, wood, nails, shoe leather, inner tube rubber, and a few bolts and iron scraps. These pumps are inexpensive, easy to maintain, and can last several years. The bamboo pumps can raise water from depths up to about 7 meters.

The water is pulled and pushed by a piston which moves up and down in the cylinder tube. The piston employs leather seals and fits snugly into the cylinder. A long wooden handle attached to a fulcrum is used to move the piston up and down.

Vital to the operation of the pump are the two one-way valves on the small bamboo tubes which connect the cylinder tube to the other two tubes. Each simple valve is made by tacking a piece of innertube rubber reinforced with galvanized iron sheet on the end of a bamboo tube, so that it will open or close depending on the direction of the water flow. The pump parts are held in place by lashing to a heavy wooden beam which is set across the top of the well.

How the Pump Works:

The pinging cycle requires **two** strokes; up and down. **On the up** stroke, the handle is pushed down, pulling the piston upward in the cylinder and drawing water up through the first one-way valve into the cylinder chamber below the piston. The second one-way valve, leading out of the cylinder into the delivery tube, is held closed by suction during this stroke.

The second stroke is made by lifting the handle, forcing the piston down. The first one-way valve **closes**, preventing the water from returning down the inlet tube. Instead, the water in the cylinder is forced by the piston through the second one-way valve and up and out through the delivery **spout**. This stroke ends with the handle returned to the first position, ready to begin another cycle. Each cycle of two strokes pumps **about** one half liter of water.

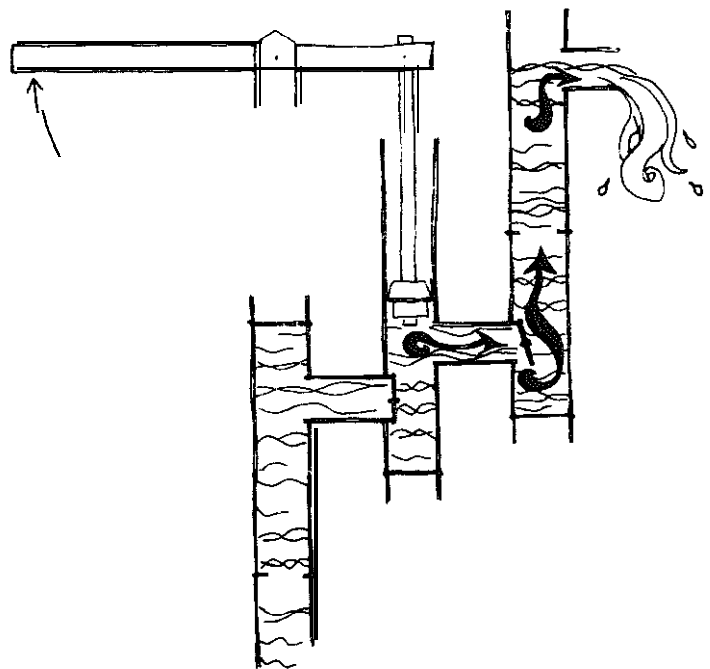
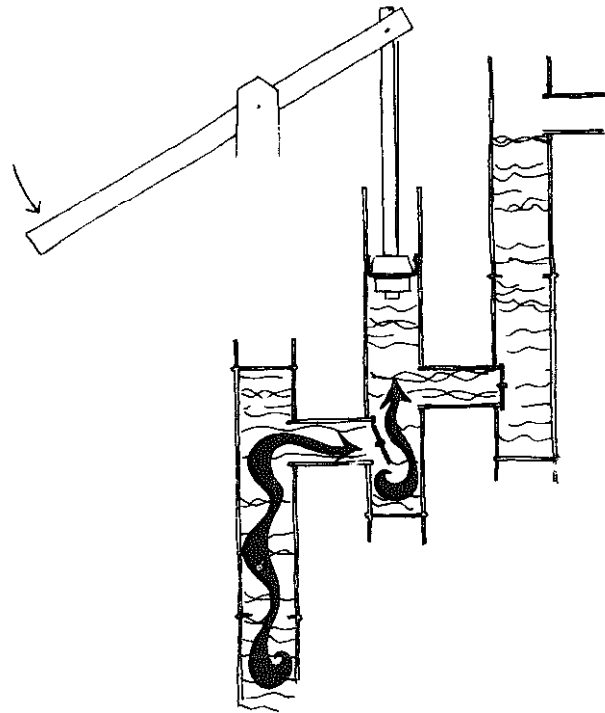

Most of the pump parts are made from mature large-diameter (8 to 10 cm) bamboo. This bamboo should be treated by soaking in water for several weeks before using; otherwise, it will stink and taint the well water after the pump is installed.

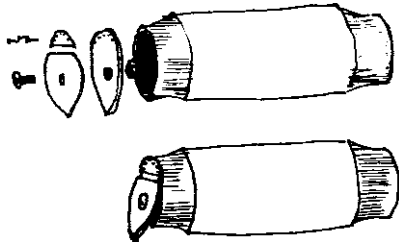

The valves should be made **first**. Two 15 cm sections are sawn from 4 cm diameter bamboo. Both ends of each tube are whittled to taper so that they will fit snugly into holes bored into the pump tubes. An egg-shaped piece of inertube rubber is cut with the round end matching the shape and size of the end of the valve tube and the elongated end overlapping the outside of this **tube** by about $\frac{1}{2}$ cm. Next a piece of sheet metal is cut in the same shape, then cut into two pieces, divided by a straight line near the round top end. This cut allows the rubber valve to hinge, while the two pieces of metal stiffen and reinforce the rubber valve. Four or five small holes are punched around the round edge of the small upper piece, tacks are driven through these holes, the upper edge of the rubber flap, and into the end of the bamboo tube, firmly attaching the flap to the tube. The larger metal piece is fastened to the rubber flap with a small bolt through the center. The flap should be able to open **and close freely**, with the rubber gap between the **two** metal pieces acting as a hinge.

The cylinder **tube** is made next. A strong round section of 8 to 10 cm diameter bamboo with at least **45** to 50 cm between the joints is selected. The bottom is cut off a few centimeters below the joint, the top is sawn off about **45 cm above** that joint. Two holes are cut for the one-way valves; the inlet hole is made just 2 or 3 cm above the joint, **and the** outlet hole is made a few centimeters higher and 90 degrees to the side. The holes must be carefully cut so that the valve tubes fit tightly into them.

The piston is then constructed to fit into the cylinder. **Two round** blocks of hardwood are cut on a lathe or carved by hand. The upper block is conical with the bottom diameter about $\frac{1}{2}$ to 1 cm larger than the top. The block is 2 to 4 cm thick and the bottom diameter should be $\frac{1}{2}$ cm smaller than the inside diameter of the cylinder tube. A **1½** cm hole is bored through the center of this top block. The bottom block has straight sides, with a diameter about 1 cm smaller than the inside diameter of the cylinder tube. A hole is drilled through the center of this second block, too. These blocks fit snugly onto the piston rod, a 3 by 3 cm piece of hardwood 45 cm long with the bottom end whittled to fit through the holes. Three round pieces of leather are cut for piston seals. (Discarded shoes are a good source of leather for this.) The top seal has the same diameter as the bottom edge of the upper **block**, $\frac{1}{2}$ cm smaller than the cylinder tube. The middle seal is cut 4 to 5 cm larger in diameter. The bottom seal is cut with a diameter about 1 cm **larger** than the diameter of the cylinder. Holes are punched in the center of the seals so that they can be fit onto the piston rod between **two** blocks. The parts are assembled and a nail or wooden pin is placed through the rod just below the bottom block to hold the parts tightly in place. A hole is drilled through the top of the piston rod to connect it to the pump handle.

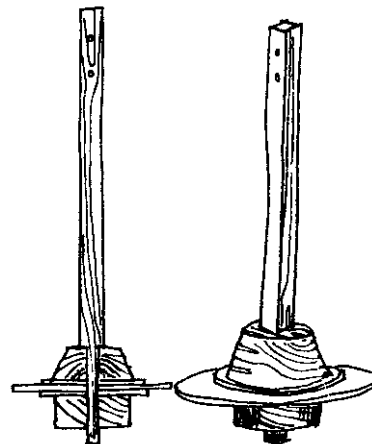

The bamboo tube for drawing the water into the pump must be long enough to reach from the water level in the well to the pump. This tube is installed upside-down, with the large end at the top connected to the pump and the small end set in the base of the well. All of the joints are knocked out, except the one at the end which will be next to the pump when the tube is installed. These joints should be left rough; they help slow the water as it moves back down the tube between strokes. Water is not drawn through the end of the tube, but rather through holes cut in the sides near the end. In deeper wells, it is advisable to install another one-way valve in the intake tube near the base, with the flap on the inside so that water drawn in cannot flow back out again. Finally, a hole is cut near the top of the tube for the valve which connects it with the cylinder tube.

The length of the delivery tube is determined by the position of the pump and the well; the water spout should empty at a convenient level. The bottom joint of the delivery tube is left intact. Two holes are cut in the tube, one near the base for the connecting tube from the cylinder, and another near the top for the spout.

All the parts are lashed to a strong wooden beam which is cut to sit firmly on the top of the well. Notches are cut in the sides of the beam to receive the three bamboo tubes. All of the joints between bamboo pump parts are painted with wood primer or another material which provides a good seal, and the tubes are lashed in place with strongwire or rope which will not rot when wet.

After the pump is assembled and installed in the well, it is ready for use. To start, the user must prime the pump by pouring some water down into the cylinder to wet the cylinder sides and the leather piston seals. After that, a few vigorous strokes should bring water pouring forth from the spout.

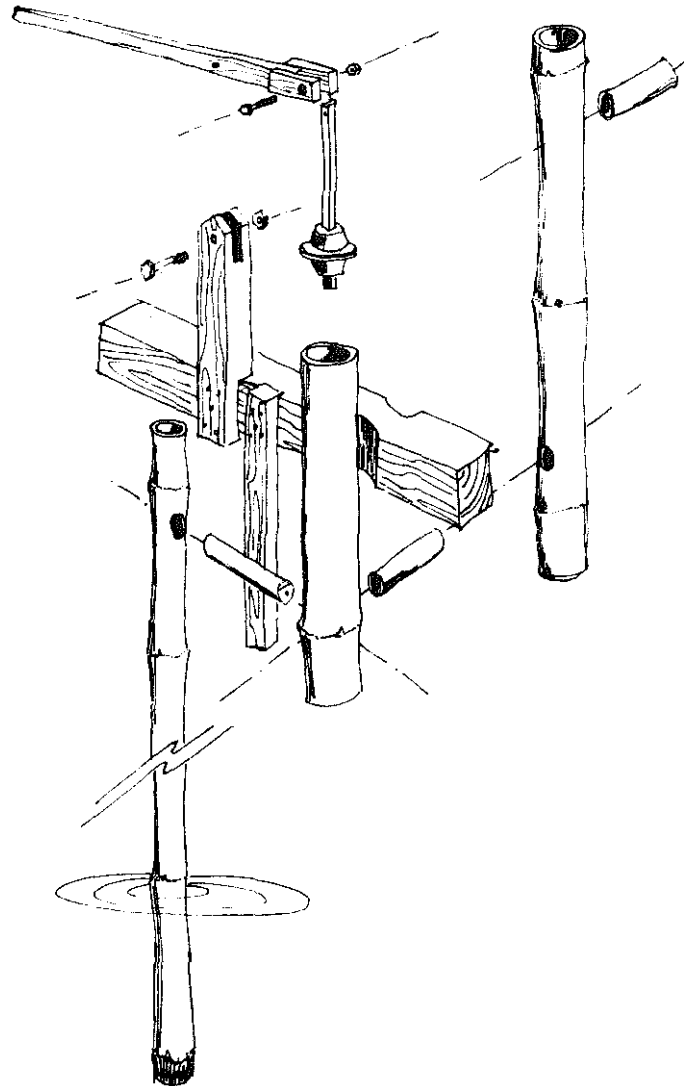

Transportation/Pengangkutan

Indonesia is a petroleum producing and exporting country, but per capita consumption of fossil fuels in the country remains low. Domestic consumption has risen considerably during the last decade as more and more motorized vehicles have come into use. Indonesia's highways are crowded with buses, trucks, and a variety of smaller public transport vehicles. Ownership of private motorcycles and cars is on the rise, too. But most short-haul freight and much passenger traffic still moves by human or animal power, making use of a wide variety of locally produced vehicles. Some of these vehicles are slowly disappearing from the scene, rendered obsolete by more modern ones. But some are extremely practical and appropriate to existing conditions in the country and shall remain on Indonesia's highways for decades to come, to the continuing annoyance of the drivers of faster motorized vehicles. Following a brief overview of Indonesian vehicles, a few of these indigenous means of transport will be described in the following section.

Human muscle power still plays a major role in Indonesia's transportation system. Crops, forest products, handicrafts, and other goods are carried along narrow paths on shoulder poles, backpacks, in *selendang* cloth slings,

or on top of the head. Vendors carry their wares around cities and towns. The bicycle and *becak*, or trishaw, two of the most efficient machines ever created, carry tremendous loads over sometimes great distances. Two-wheeled barrows and carts are commonly used in the cities for building material delivery and trash collection, and by vendors hawking their wares in residential areas.

Draft animals are still widely used in Indonesia. Pack horses are used in some mountainous areas. More common are a variety of *gerobak* (carts), small ones pulled by a single horse or cow, and very large ones drawn by two cows. Ornate carriages, called *delman*, *bendi* or *andong*, are still used to carry passengers in Sunda, Java, Bali and parts of Sumatra.

Modern motorized traffic in Indonesia bears little resemblance to that of Western nations. Thousands of small Japanese motorcycles zip in and out between the trucks, buses and cars, often carrying as many as 4 or 5 people, or loads more suited for a pickup truck. Three or four wheeled *bemos*, with 2-stroke engines fill the air of most cities with their

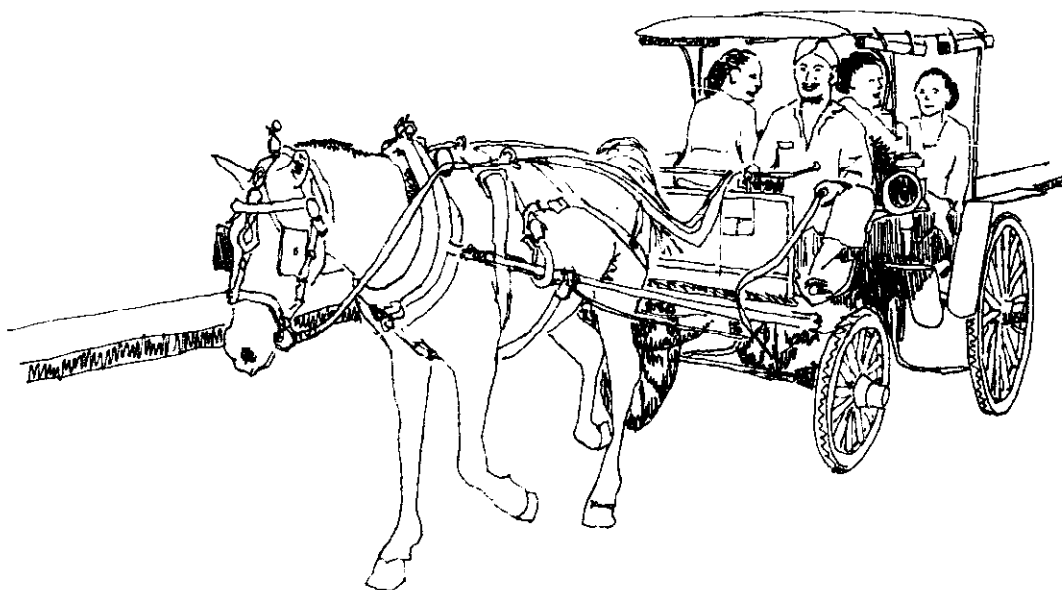

grating roar and blue smoke. These tiny vehicles carry 7 to 12 passengers crammed onto two benches facing one another in the back. *Oplet*, small buses made from 1930's to early 1960's model American and European pickups and cars, seem to set new endurance records daily as their ancient engines and suspensions transport up to 30 passengers at a time, reaching roads more suited for mountain climbers than 4 wheeled traffic. *Colt and Mikrolet* Japanese pickups and minibuses are supposed to be replacing the venerable *oplet*, but most people doubt that they will last that long. Buses and trucks carry loads far beyond their rated capacity at speeds that would be unsafe on the best of roads, making Indonesia's highways some of the most dangerous in the world.

There are trains in Java and Sumatra, though the amount of track in use has dropped since colonial times when the system was built. Ancient wood-burning steam locomotives, including some of the oldest working engines in the world, still operate alongside modern diesels.

Although it is a nation of more than 13,000 islands, Indonesia lacks a modern merchant marine. The **Bugis** of **Sulawesi**, once the most feared and respected seamen from Madagascar to Taiwan, still own and operate the largest wind-powered sailing fleet in the world. Some small motorized freighters ply the islands, but in many of the outlying areas, the price of basic commodities and consumer goods is more dependent upon the prevailing winds than domestic and international market factors. There is a government program of low-interest loans and other assistance to motorize the fishing and coastal sailing fleet.

Indonesia has three government airlines and a few small private carriers. The fleet ranges from prop-driven planes to large intercontinental jets. Poor management and lack of navigational equipment cause many delays and cancellations. Indonesian domestic air service is one of the most expensive per kilometer in the world.

From the variety and number of vehicles on the move throughout the country, one gets the impression that most Indonesians spend most of their time travelling.

Shoulder Poles/Pikul

A springy section of strong thick bamboo, strong legs, and calloused shoulders combine to form one of the most common means of transporting cargo in Indonesia. *Pikul* is the Indonesian term for carrying things on shoulder poles. It is also the name for the shoulder pole itself. In many dialects, it also denotes a measure of weight or volume; the amount which a man can comfortably *pikul*, about 40 to 50 kg.

The shoulder poles are usually made from bamboo. The base of a large mature bamboo is sectioned into quarters or sixths. These sections are cut to a length of 120 to 200 cm, depending on the type of load to be carried. The center which rests upon the shoulder is about 4 to 5 cm wide; the ends are tapered to give them more spring. Both ends have notches or pegs to hold the rope, rattan or bamboo used to hang the loads. The nodes are removed and the poles are scraped smooth; with use they take on a high polish.

A limitless variety of items are transported in this manner. The container and hanging method vary with the nature of the load. A few examples presented below demonstrate the versatility and practicality of *pikul* as a means of transport.

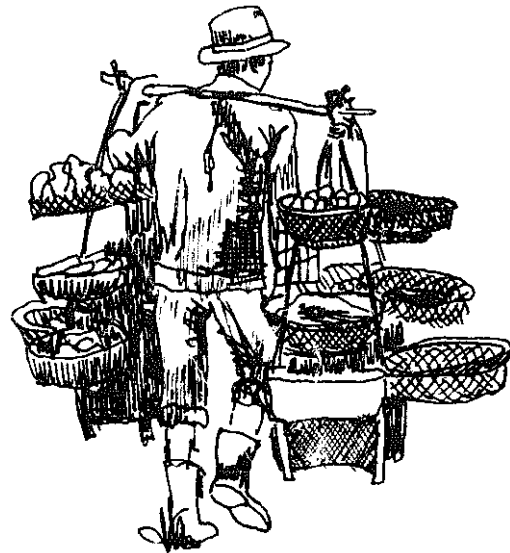

A vegetable vendor carries more than a dozen different types of vegetables and fruits, along with spices and other household necessities in his "walking market." Each item is arranged in individual rattan baskets lashed to the rattan frame of his *pikul*.

At closing time, the owner of this "portable restaurant" packs up his snacks, utensils, stove, pots, pans and stool and carries it all home, returning the next day with a fresh supply of food and drinks. Most of the preparation is done at home; the only cooking done on site is to heat the snacks.

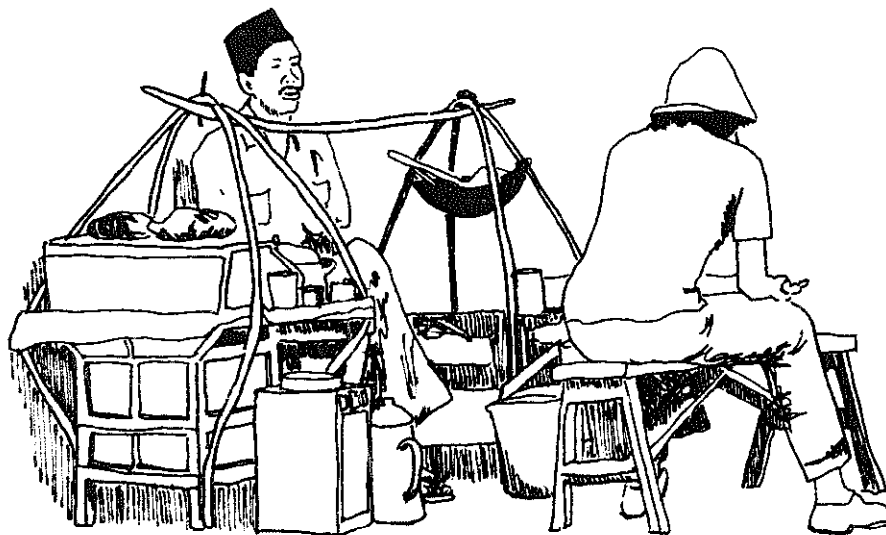

A *krupuk* vendor carries comically large tin cans of his product. *Krupuk* are fried crackers made of cassava, rice or wheat flour flavored with fish, shrimp and spices. They are very light for their volume, hence the huge cans are not as heavy as they appear.



"*Kampung bulldozers*" are common at construction and earthmoving projects throughout Indonesia. Large crews of them dig and fill their scoop-shaped bamboo baskets with earth and sand, hoist them and quickly carry them off to be dumped elsewhere.

One very useful type of *pikul* found in Sunda and Java is the *sundung*. The triangular bamboo frames can carry large amounts of long stackable material like grass, firewood, or leaf and root vegetables. They are particularly con-

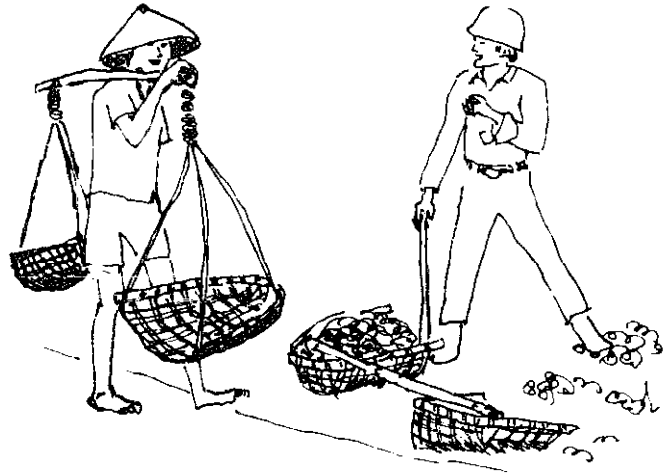

venient for gathering grass or firewood because the cargo can be stacked into the *sundung* as it is picked up, instead of being assembled into full loads and then bundled for transport.

A man experienced at carrying things by *pikul* develops a characteristic gait. His hips swing, but the upper half of his body is almost still, causing the load to bob only slightly. He times rapid short steps to coincide with the upswing of the bouncing load. He can shift the load from one shoulder to the other by rotating the pole into position, bouncing the load upward, and then twisting his shoulders without ever losing stride.

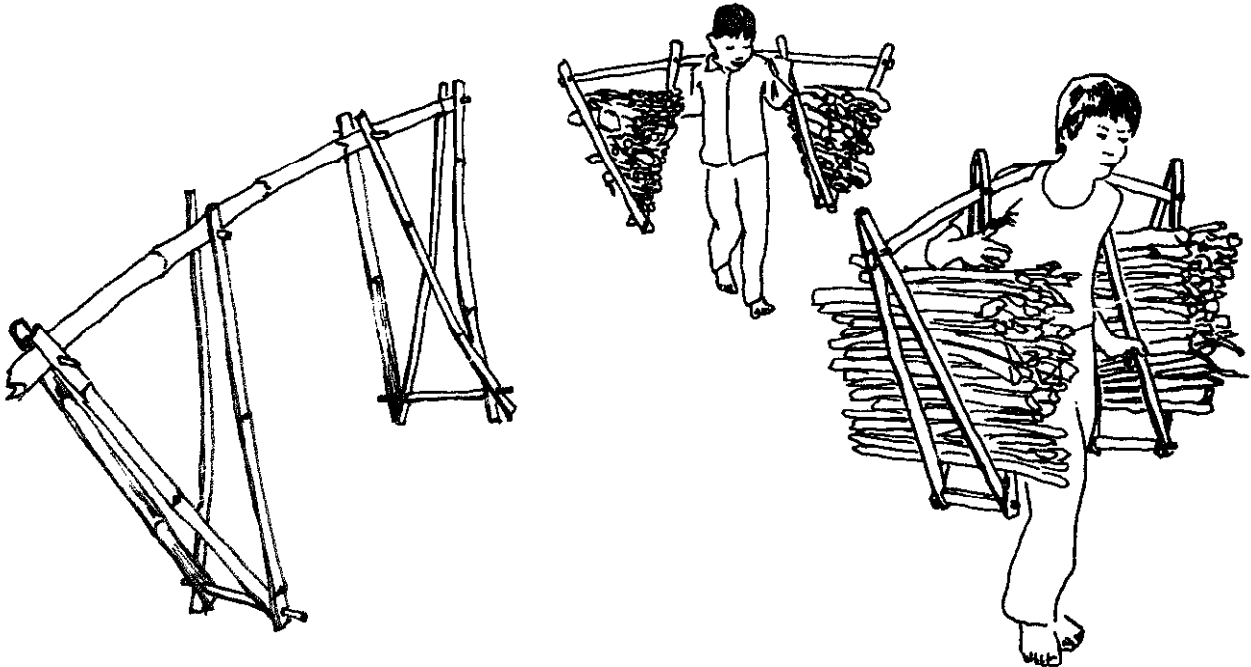

Bicycles/Sepeda

The bicycle is one of the most efficient machines ever developed by man. Bicycling makes more effective use of human energy than walking. Besides carrying the rider, bicycles can be used to transport another passenger, or large amounts of freight. A bicycle equipped with carrying baskets can carry more weight than a walking man, over longer distances and in less time, as long as the surface is sufficiently hard and smooth for a bicycle to pass.

Most bicycles sold in Indonesia are equipped with a 13 by 40 cm luggage rack bolted above the rear wheel. Besides doubling as a passenger seat, this rack can support specially made baskets or boxes for cargo transport. A tremendous variety of cargos are carried on bicycles in this way, and often the weight or hulk of the load seems staggering. Some examples are shown below:

The top drawing is of a fruit vendor returning home with his empty baskets. Two large bamboo baskets are hung from the sides of the luggage rack on 2 bamboo poles which pass through holes near the tops of the baskets. A third basket is set on top of the other two to increase the load capacity. This top basket, and any cargo that sticks out above the tops of the baskets is strapped into place with a section of bicycle inner tube. Bicycles like this often carry well over 100 kg of freight.

One very convenient type of bicycle carrying basket is the Yogyakarta *kronjot*. This double basket, constructed in one piece from strips of bamboo, can be easily removed when not in use. *Kronjot* are made in various sizes, from about 25 by 30 by 30 cm to 30 by 40 by 50 cm for large loads.

Tahu bean curd cake vendors use special wooden racks which hold 20 liter rectangular cans to transport their product. The fragile cubes of *tahu* float in water inside the cans. One bicycle usually carries 4 cans, weighing as much as 80 kg when full.



Fruit vendor with empty baskets.

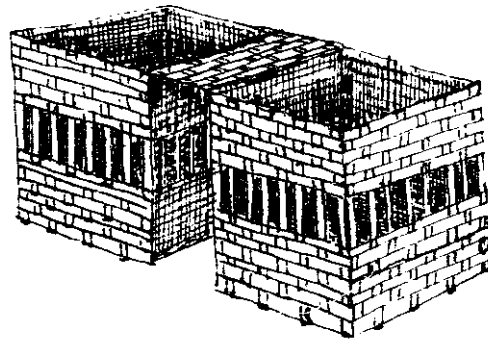

Kronjot.

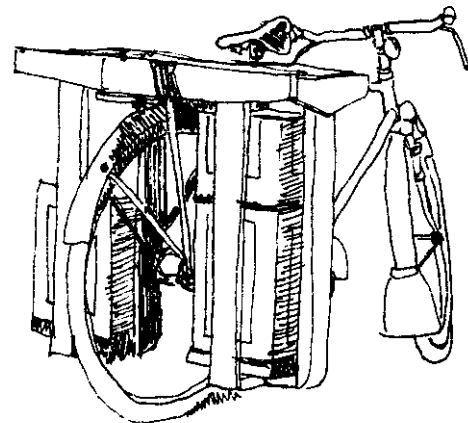

Rack for bean curd cans.

A *krupuk* fried shrimp cracker vendor uses a comically large sheet metal box to carry his product. The big box is divided into 3 or 4 separate compartments to carry different types of *krupuk*. Because fried *krupuk* is light and airy, the box which dwarfs the bicycle and rider weighs no more than 50 or 60 kg when full.

Sometimes bicycles carry cargoes so large that the bicycle has to be pushed instead of ridden. The load of pots being pushed to market appears to be gilding along above the ground. The bicycle is loaded so fully that it cannot be steered, and is pushed from behind. To turn the bike, the man stops, walks around to the front, and lifts the bicycle to point in in the new direction. This load is at least 3 times as large as loads that can be carried on a *pikul* shoulder pole.

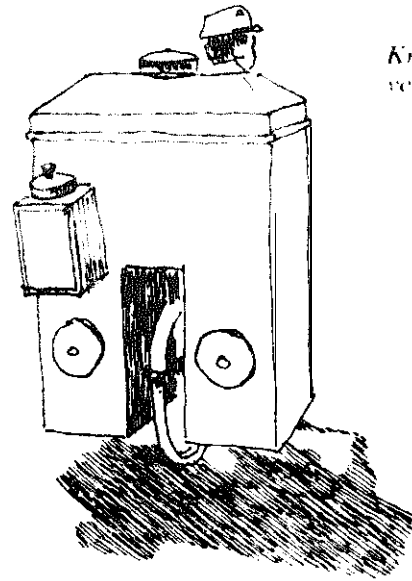

Krupuk
vendor.

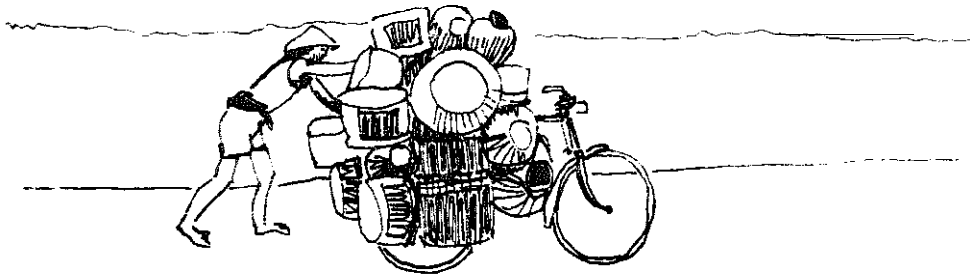

Trishaw/Becak

Like the bicycle, the pedal-powered *becak* trishaw makes efficient use of human muscle power to transport passengers and freight. Introduced by the Japanese during World War II, *becak* soon became one of the most common forms of transportation in Java's cities and towns. In Bali, Sumatera and a few other places, *becak* are not used, as using human

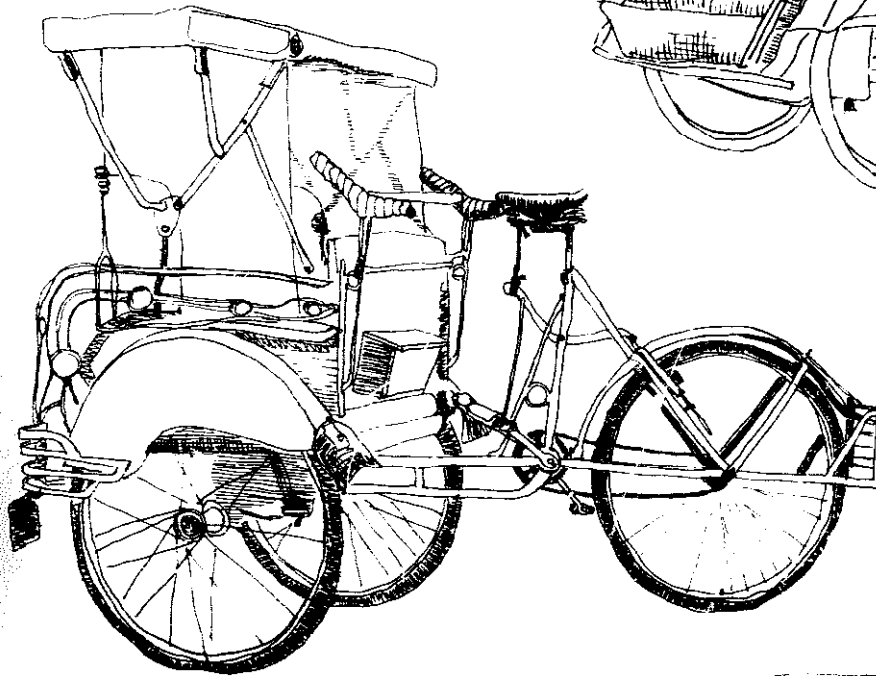
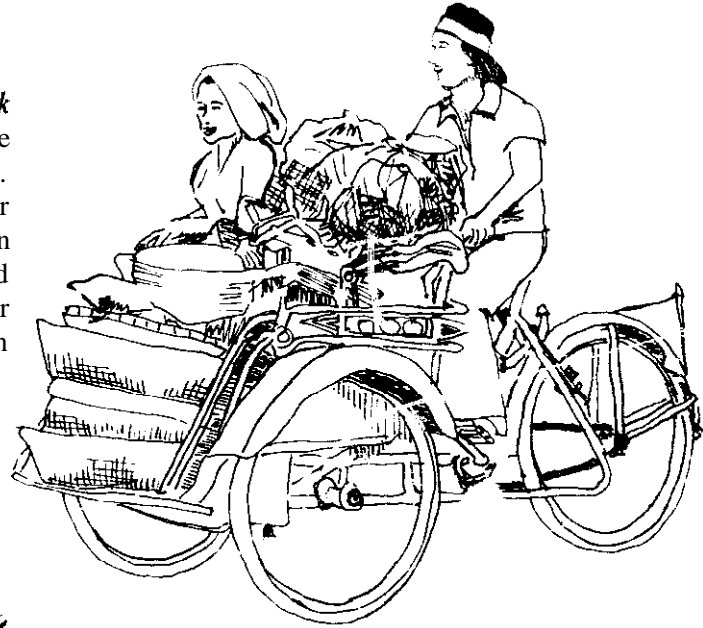

power to transport other humans is considered **degrading**. The Indonesian government is also trying to eliminate *becak* because they congest traffic in the crowded cities. The first modern cloverleaf interchange built in Jakarta during President Sukarno's time has special *becak* lanes twisting under it; now those lanes are used for motorcycles. Most major cities now have *becak-free zones*, and eventually *becak* will be banned entirely. They employ thousands of people, but *becak* drivers are a notoriously rowdy and unruly group. Though some drivers own their own *becak*, most rent them. This also is a source of annoyance to the government: most of the owners are Chinese.

Except for the running gear, wheel rims and spokes, and drivers' seats, *becak* are entirely manufactured by local craftsmen. The

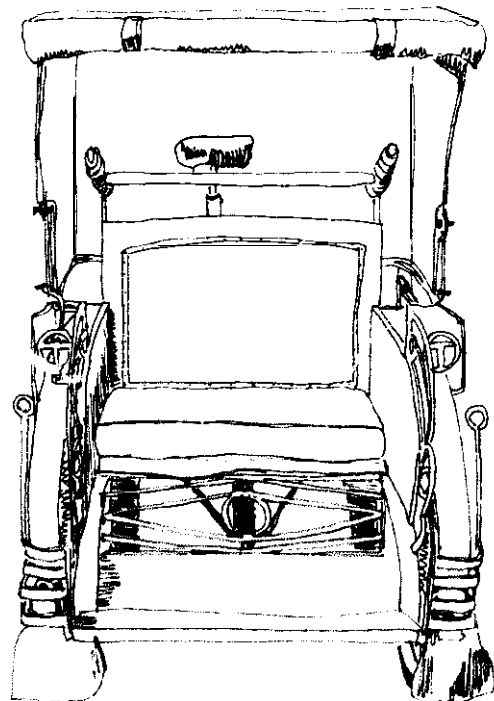

sturdy frames are welded iron pipe and rod; the fenders are **heavy sheet** metal. The passenger **compartment** has a metal frame with wooden sides and back. The padded seat is removable. The canopy is made of heavy oiled canvas, with a metal frame which can be folded down for **large** loads or **evening** cruising.

Tire brakes operate by pressing two chunks of tire rubber against the rear wheel rim. Unfortunately, front wheel brakes would be complicated to build and keep adjusted, so the *becak* driver must **depend** on only the back wheel for stopping. The brake lever is located between the driver's legs, sometimes connected to a pedal attached to the frame above the crankset.

The **undercarriage** is very well designed. The axle is clamped to short leaf springs made from used **automobile** springs. The bicycle frame is attached to the front carriage just behind the **axle** by a sturdy headset which employs locally cast and turned cone-shaped brass bushings. This part must be very strong to support the tremendous torque and load.

Even the front hubs are locally produced, turned from aluminum with steel spoke flanges. Ball bearings fit snugly into the hub and over the lathed end of the iron **bar** axle.

Becak from different areas differ in the shapes of their carriages, cloth tops and fenders, and in their dazzling paint jobs. *Becak* decoration is one of Indonesia's many fascinating living art forms, its techniques and originality unsurpassed by almost **any** other art form currently practiced.

Becak carry large loads; **two** to four people or a large pile of freight. Before the government eliminates *becak*, means will have to be available to replace the enormous transportation service that they provide.

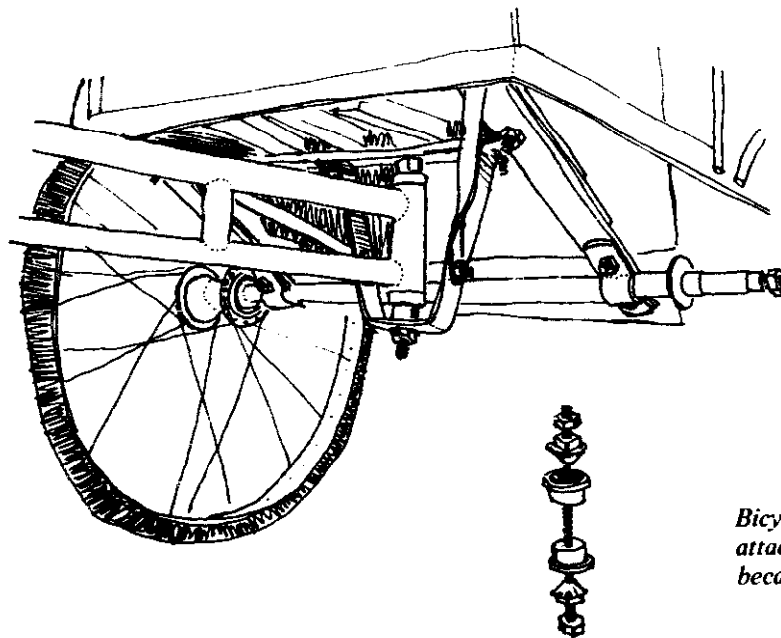

*Bicycle frame
attachment to
becak carriage.*

Freight Tricycle/ Becak Pengangkut Barang

In **Sumatera**, pedal-powered *becak* are not used to transport passengers, but only to carry freight. This vehicle is called a *becak dayung*, meaning "pedalled" *becak*, distinguishing it from the motorcycles equipped with special sidecars, also called *becak*, which transport passengers on that island. The *becak dayung*, identical to the **trishaw** common in Malaysia and Singapore, has a third wheel and carriage bolted onto the right side of the bicycle frame. The platform of this carriage can be loaded with up to **500 kg** of freight. Except for the specially reinforced forks, the bicycle is a standard heavy duty model imported from **China**.

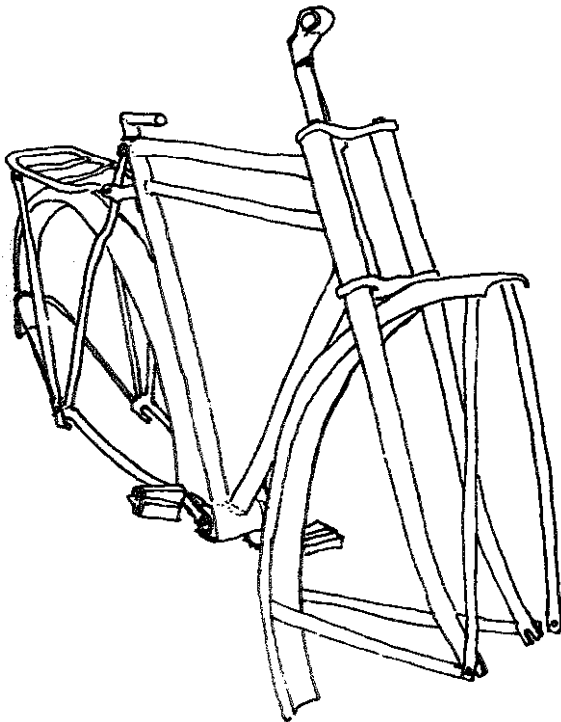
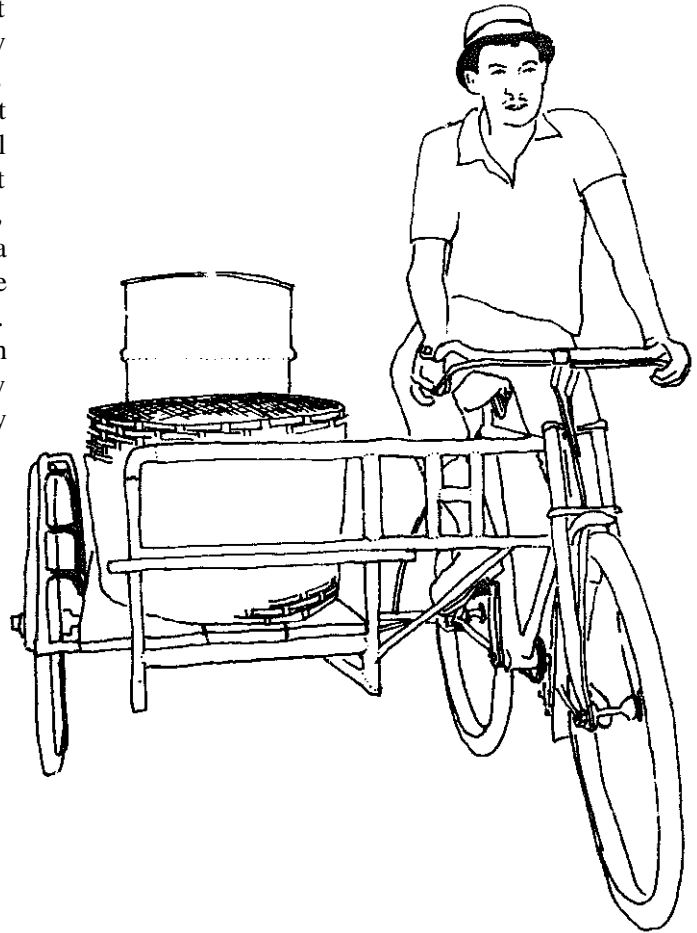

The heavy-duty bicycle frame is altered slightly to accommodate the *becak* carriage and the heavy loads it will carry. *Becak* forks are made of heavier gauge pipe and have two brackets at the top, one above and one below the headset, instead of forking into the tube which fits into the headset as on regular **bikes**. A second top tube is welded to the frame below the original one, and a **XI-degree** seat post is installed to allow the seat to be adjusted forward as well as up and down. Riders claim that the forward seat position allows them a better posture for **pedalling** the heavy loads.

The **48-tooth** front chainwheel is replaced with one that has either **36** or **24** teeth, depending on the size and type of loads the *becak* will be carrying, and the local **terrain**.

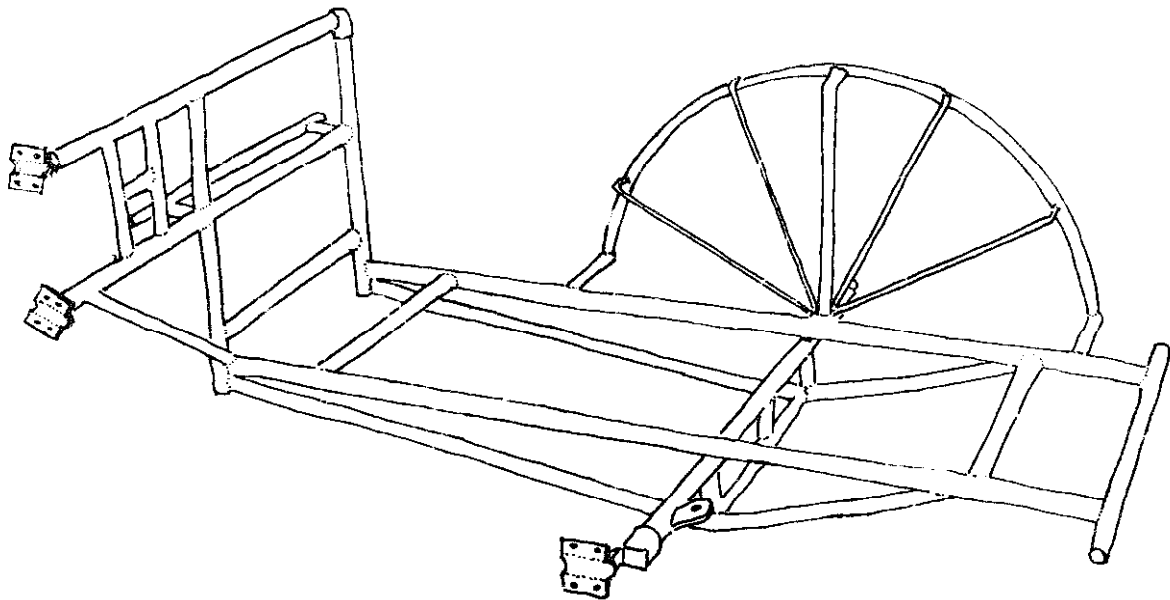

The iron frame of the *becak dayung* carriage is manufactured from 1-, $\frac{3}{4}$ -, and $\frac{1}{2}$ -inch ungalvanized iron pipe, with a $\frac{3}{4}$ -inch solid iron axle. It is very strong, usually outlasting the bicycle by several years.

The carriage is connected to the bicycle frame by three iron clamps welded onto pipe sockets, which screw onto the ends of the carriage frame members. Each clamp is made of two pieces of 3 mm iron plate bent into a half cylinder with flanges top and bottom for four bolts. When installed, these clamps are lined with pieces of bicycle inner tube rubber. A rod extends from the seat post bolt to a flange welded onto the carriage axle to keep the bicycle rigid and to prevent freight from falling against the rear wheel.

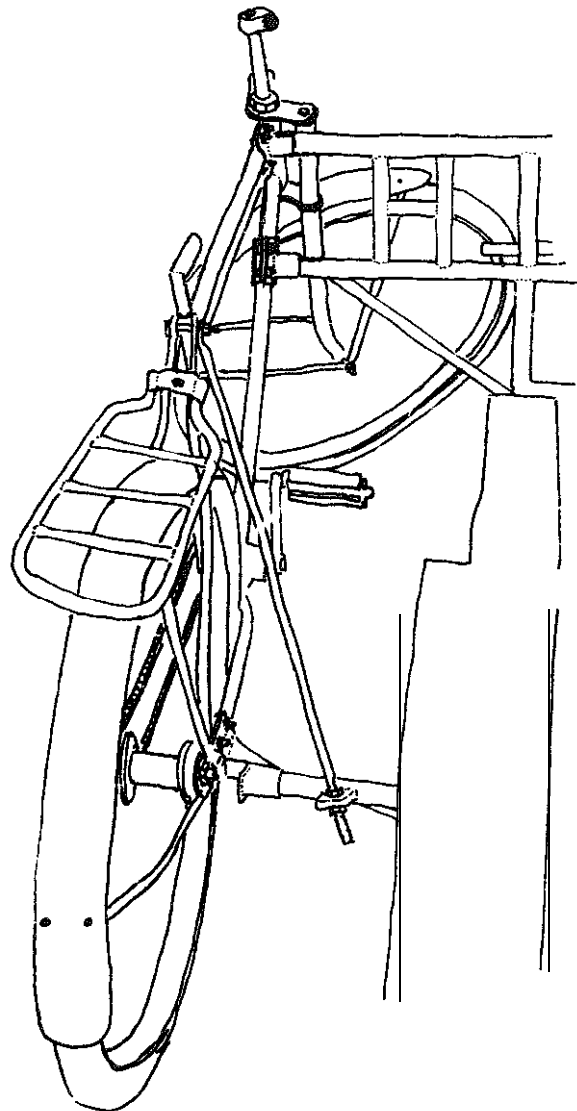

The end of the carriage axle is lathed to accommodate the wheel bearings and a bolt. The inner bearing has an inside diameter of 25 mm and fits snugly against the welded flange located just outside the fender assembly. The outer bearing fits onto the 20 mm diameter section near the end of the axle, and the hub and bearing assembly is held in place by a 3/8-inch nut.

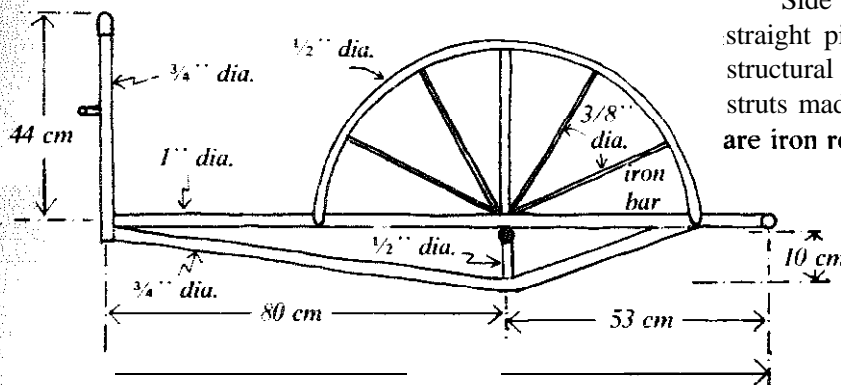
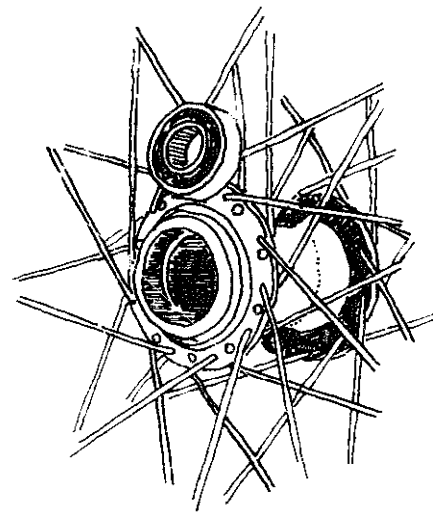
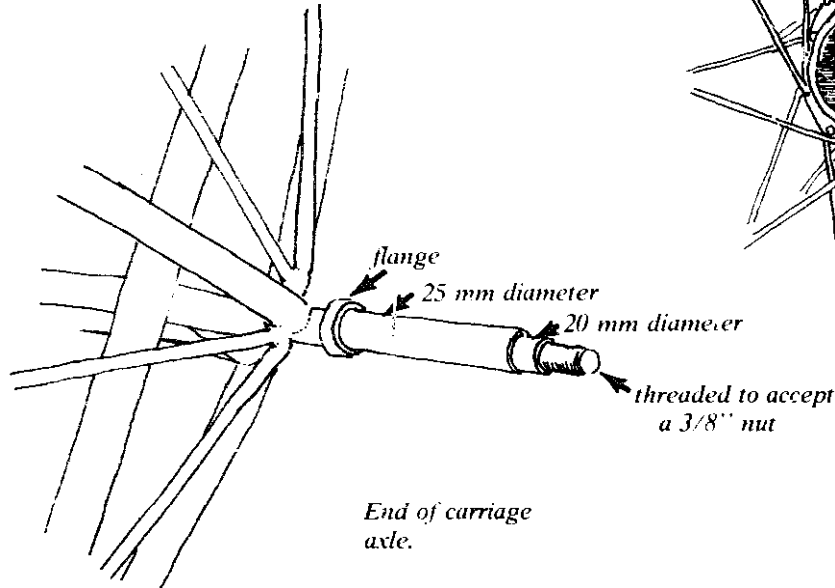

Side view of the carriage frame. The long straight pieces are 1-inch pipe and most other structural members are 1/4-inch pipe, with short struts made of 3/8-inch pipe. The fender spokes are iron rod.

Section view of the axle assembly, the strongest part of the frame. The axle is 1/4-inch iron bar. The diagonal struts are 3/8-inch iron rod, and the other parts are 1/2-inch pipe.

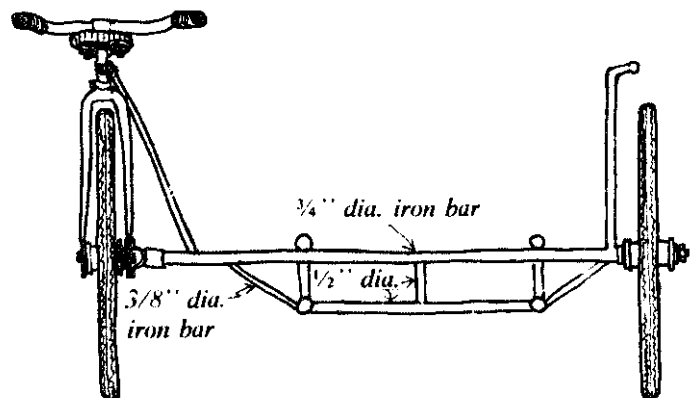

Plan view of the carriage frame. The wooden platform boards bolt onto the pipes at the front and rear of the frame

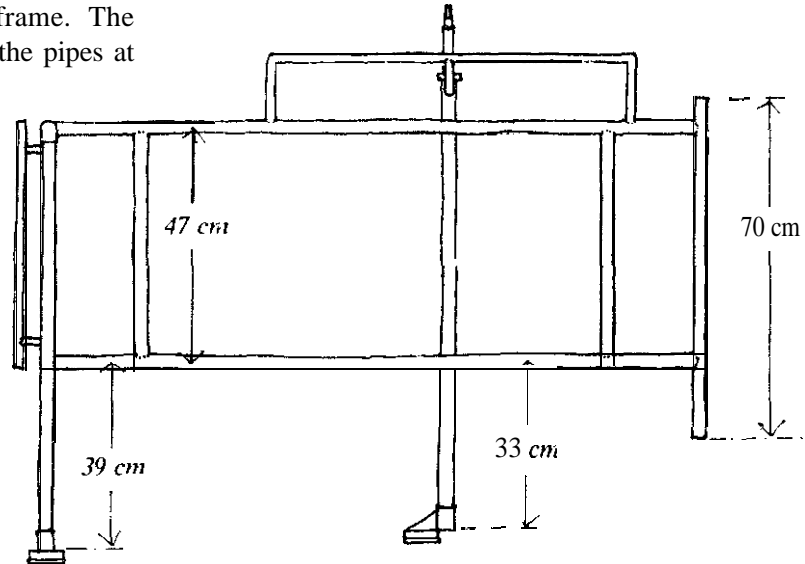

The three wheels are laced with special spokes to take the heavy loads. Specially reinforced forks, the carriage frame and the hub are all manufactured in **Medan** in northern Sumatera. They are sent to cities throughout **Sumatera**, where they are painted, assembled, and have the wooden platform installed. This sturdy *becak selis* for less than twice the price of a standard bicycle.

Carts/Gerobak

Two-wheeled *gerobak*, carts or barrows, pushed or pulled by one or two people, are only practical on smooth relatively flat roads. Even in the towns and cities where these conditions exist, *gerobak* are not used as much as *becak* or *pikul*. Indonesian *gembak* are made in various sizes, of varying **strength** and construction depending on their purpose. They use bicycle, motorcycle, automobile or truck wheels, depending on the **size** and weight of the load carried. *Gerobak* are used mostly for garbage collection, short-distance transport of building materials, and vending of food and household goods.

Most building material outlets own a few *gerobak* for local deliveries. The *gerobak* use automobile wheels, the hubs welded to a pipe axle. The box measures about 40 X 50 X 75 cm.

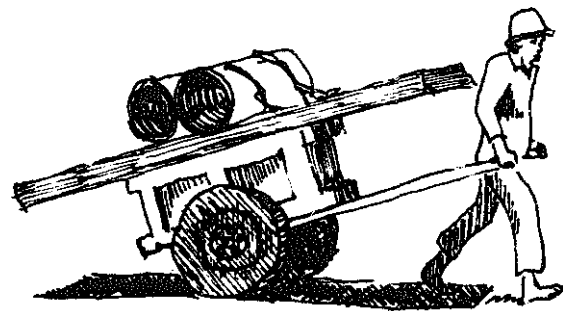

It can be filled with sand, bricks, or cement, and larger materials can be lashed on top. One man can pull up to 200 or 300 kg of materials with such a *gembak*.

Transporting heavy teak logs from depots to sawmills requires larger, stronger *gerobak*. These sturdy carts use automobile or truck wheels and axles, usually the rear axle with the differential removed. Two men, one pushing and one pulling, can transport logs weighing over a ton.

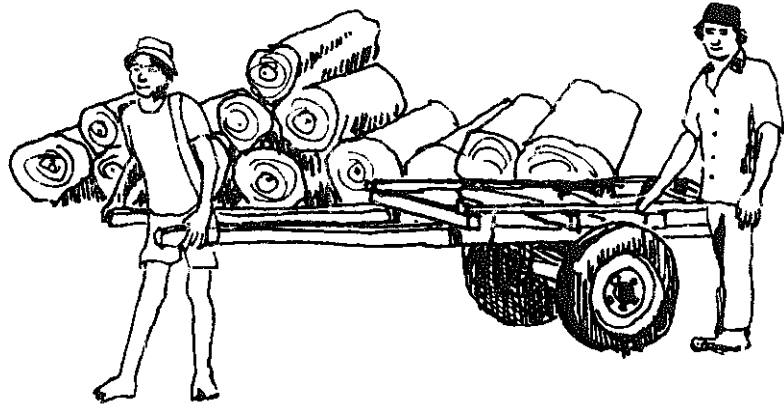

Kaki lima, meaning "five feet," is the name given to vendors who use *gerobak* to transport their wares. The name comes from the vendor's own feet, plus two wheels and a peg to support the cart when stopped. Some *kaki lima* sell vegetables, kerosene, brooms, or other household necessities, while others actually push around complete kitchens, selling noodles, sate (chicken or goat meat cooked on skewers), drinks, or other foods. The *gerobak*'s distinctive shape and décor, along with the vendor's particular call, knocking, ringing or whistle clearly identify what is being sold as the vendor pushes his *gerobak* through residential streets.

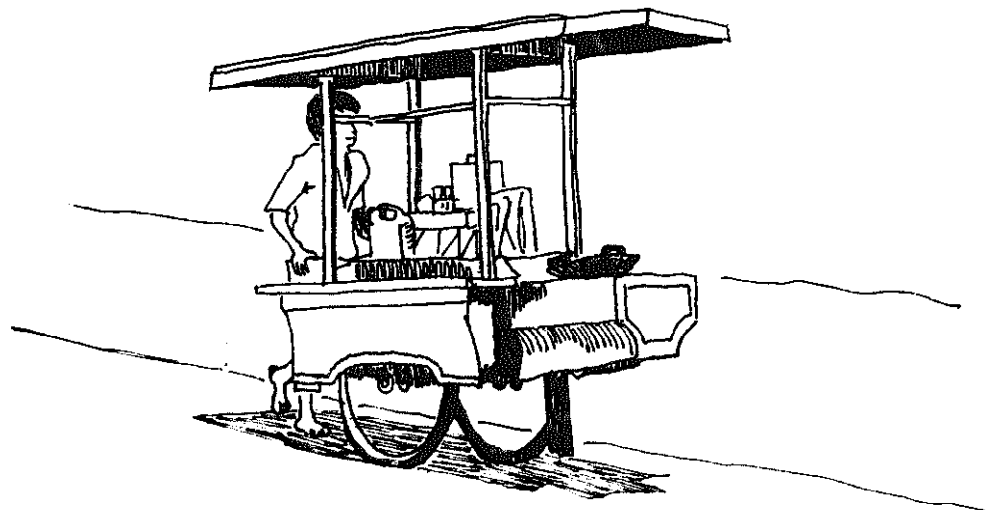

Animal-drawn carts, sometimes pulled by a horse, but usually by one or two cows, are also called *gerobak*. These *gerobak* are still very common in villages and rural areas, where they are used to transport crops from the field, or materials such as bricks, firewood or bamboo poles to places where they can be sold or loaded

on trucks for longer trips. Some *gerobak* still use wooden wheels, like this example from West Java. The steel rims of the locally crafted wheels can cut into asphalt pavement if the *gerobak* is carrying a heavy load, and the use of vehicles without rubber tires is now outlawed on some roads. More common than steel rims are rubber rims made by nailing strips of truck tire to the wooden wheels.

Animal-drawn *gerobak* were introduced to Indonesia about the twelfth century. With the exception of the truck wheels and rear axle, and the sheet-metal roof, this Yogyakarta *gerobak* is identical to the ancient Indian carts upon which it is modelled. The brightly decorated sides are made of woven rattan and bamboo. The cows are protected with slippers made from rubber, tied on with straps of the same material.

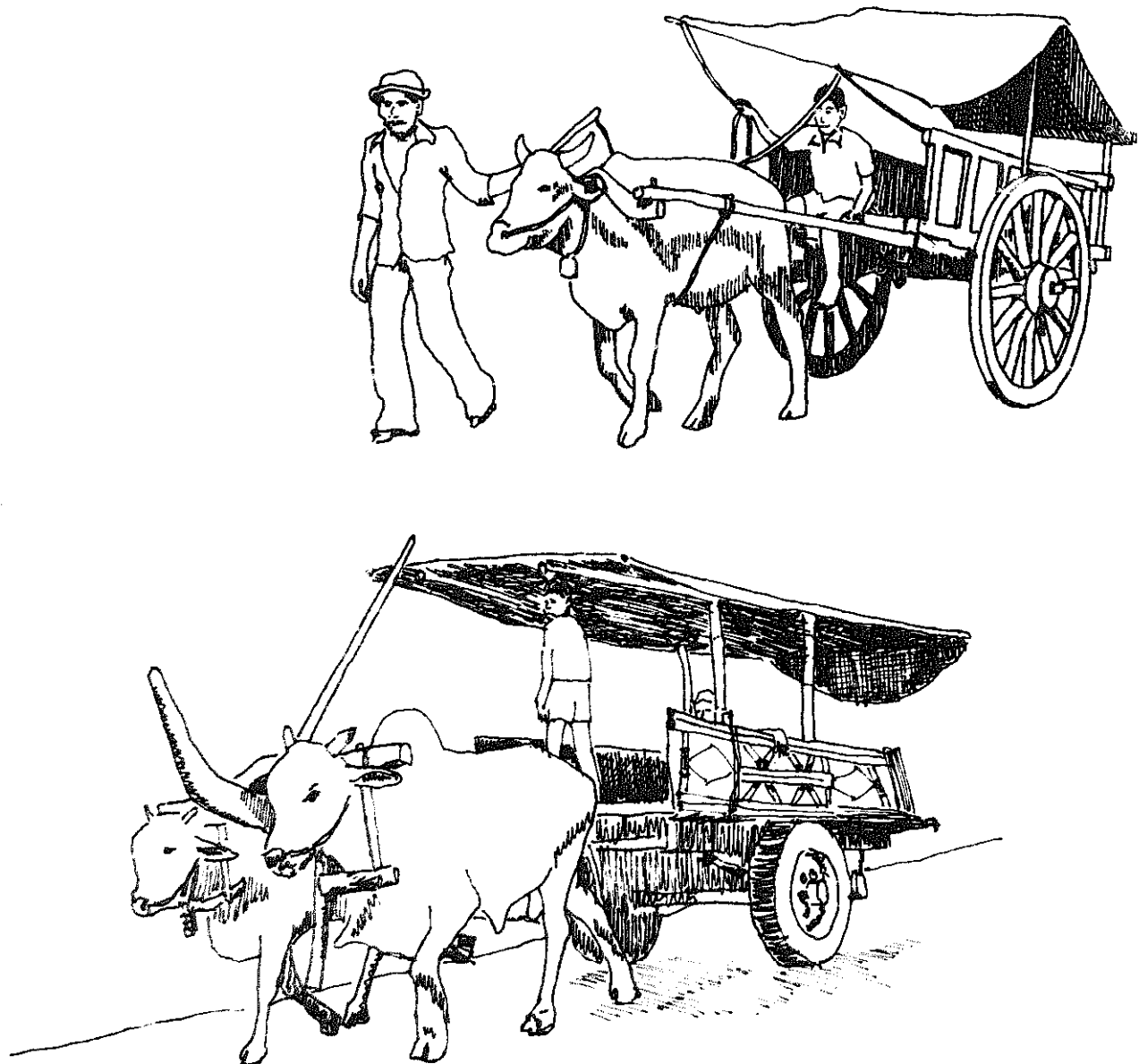

Homemade Minibus/Oplet

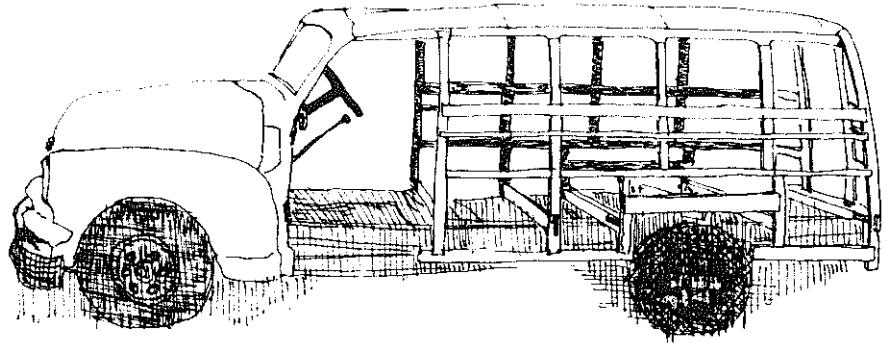

Chevrolet, Ford, Morris and Fiat sedans and pickup trucks with locally-made hardwood and sheet-metal bodies and benches are called *oplet*. The front of the car or truck, as far back as the windscreen and dashboard, is original. The cab is replaced by a larger body made of a strong hardwood frame and sheet-metal skin. Behind the driver's bench are one or two more benches facing forward, and in the back section, reached through a rear-facing door, are two more parallel benches with an empty space between for cargo.

Although officially allowed to carry only 9 passengers, *oplet* often carry as many as 25 people and their goods, or freight weighing as much as a ton or more. They can brave! over roads and pathways that are impassable to most other vehicles.

Oplet engines are usually serviced only when they completely cease to run. They must be torn down and rebuilt about once each year. The bodies last about 5 years, the last one or

two of those in a rickety and patched condition. Then they are torn down to the chassis and completely rebuilt. Sometimes two or three old *oplet* contribute parts for the construction of one new one.

The Indonesian government has lately been trying to replace the *oplet* with more modern vehicles, outlawing them in certain cities or parts of cities, and giving their routes to recent Japanese-made *Colt* or *Microlet* vehicles. The result of this policy has been that the durable and tenacious *oplet* are being moved out into the villages, providing better and regular transportation service to more and more remote areas.

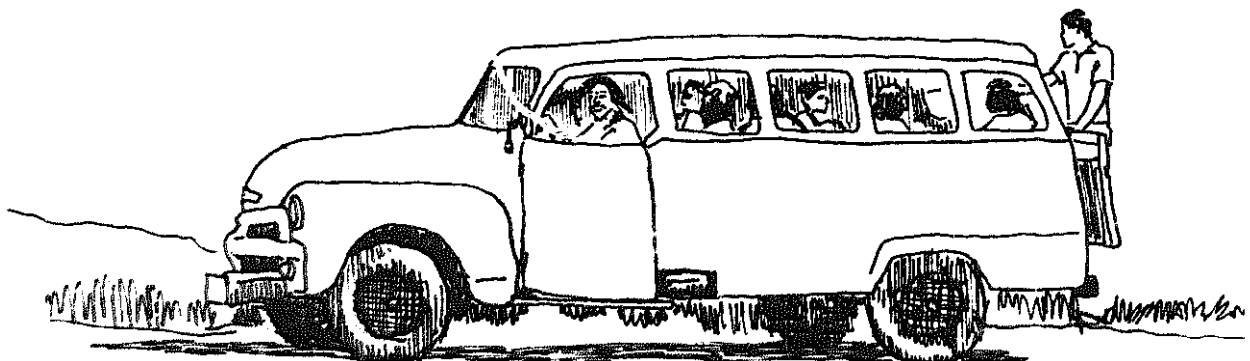

Bamboo Truss Bridge/ Jembatan Bambu

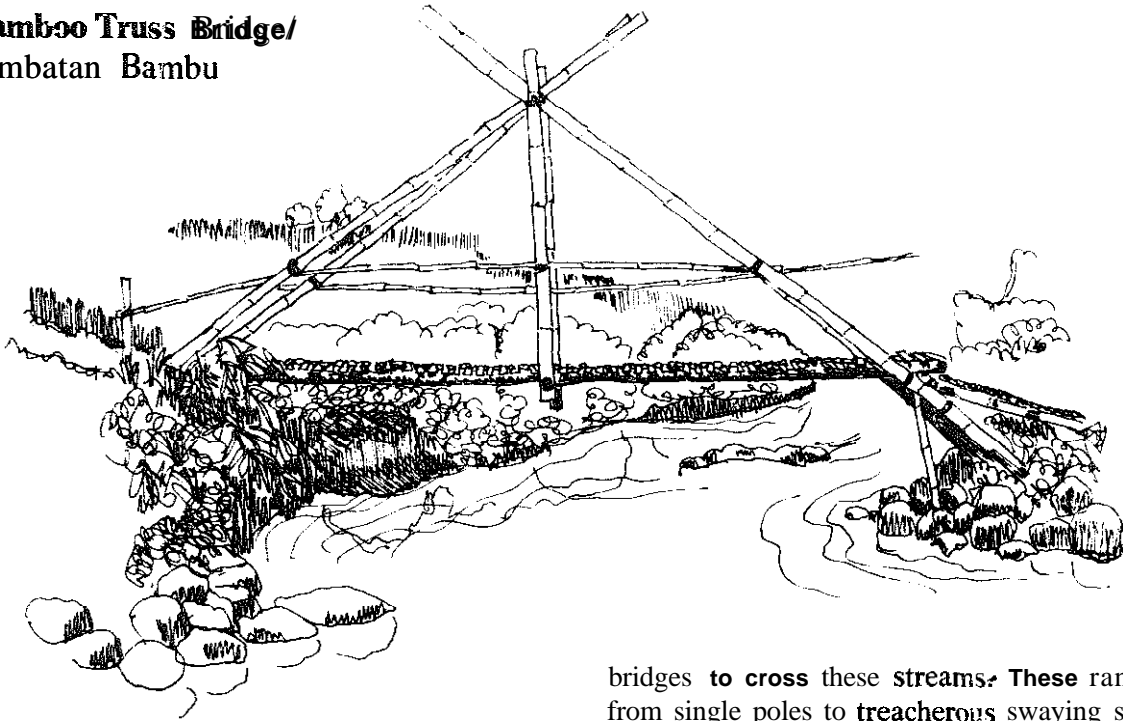

Although roads passable to motor vehicles now reach many of rural Indonesia's remote villages, a majority of commerce and traffic in the villages still moves on foot. Much of the country is mountainous and has high rainfall; the terrain is criss-crossed with streams and rivers. Local communities build and maintain

bridges to cross these streams. These range from single poles to treacherous swaying suspension bridges.

One of the most common designs, used to cross streams between 3 and 10 meters wide, is the elegant A-frame truss bridge. The bridge derives its strength from the two A-shaped trusses made by crossing four (two to a side)

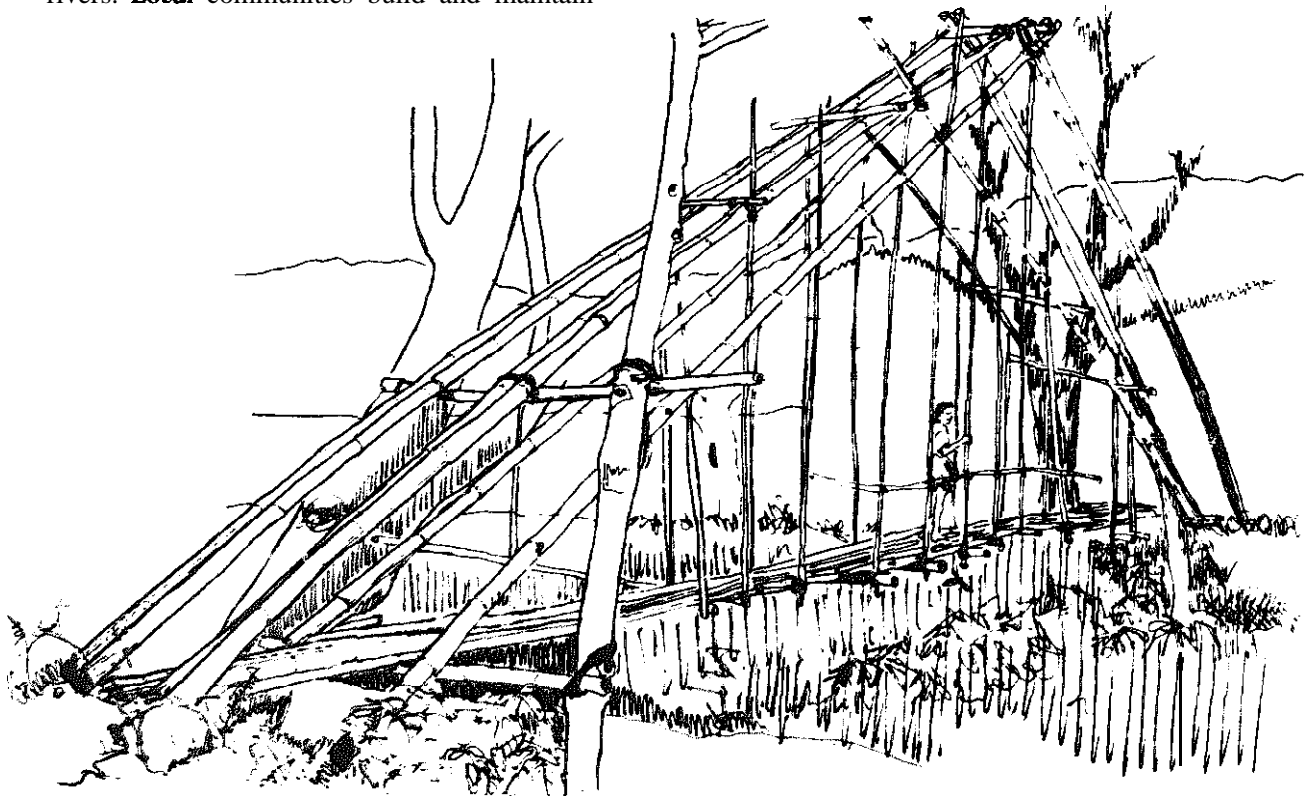

bamboo poles across the river with strong pinned and lashed joints at the top. The poles are firmly anchored in the banks on the opposite sides of the stream. Poles pinned and lashed to the trusses support a bamboo beam under the walkway. Bridges with short spans require only one such beam; longer spans of 5 meters or more require several interspaced along the length of the bridge. The walkway is framed with bamboo poles and covered with plaited

sticks of split bamboo or parallel bamboo poles.

Members of the communities that use the bridges build and maintain them. Minor repairs are made on the spot by whoever sees the loose lashing or cracked pole. If a major overhaul is needed, a *gotong-royong* work party is organized to rebuild the bridge. (*Gotong-royong* is a participatory, "ban-raising" approach to community work which is a strong Indonesian tradition.)

Architecture, Housing and Construction/ Arsitektur, Perumahan dan Bangunan

Indigenous systems of family and community shelter design throughout **Indonesia** have evolved to fit local conditions. Besides using locally available materials, **they** are usually well suited to local environmental conditions.

The appropriateness of traditional designs in Indonesia was apparent in the aftermath of the 1976 earthquake in Northern Bali, which caused **many casualties** and great destruction of property. The day **after the** quake, newspapers carried pictures of some of the **devastated villages**. The only structures left standing were traditional rice barns and some old style **houses owned** by villagers reluctant (for **cultural** or financial reasons) to build more "modern" homes. Hundreds of newer buildings, including schools, offices, houses and clinics, were reduced to rubble, many burying helpless victims inside.

Indonesia offers almost as many architectural **designs** as there are villages. Indigenous housing includes crude **treehouses** in the forests of Central **Sulawesi**, enormous Dayak longhouses sheltering whole communities in **Kalimantan**, cool and serene **Javanese Joglo**, beautifully decorated homes of the **Batak**, **Toraja** and **Minang** people, the dwellings on stilts and the boars of the **Badjo** communities, the hastily **constructed** slums built from trash which house thousands of newcomers in Indonesia's major cities in surprisingly orderly and sanitary conditions, and many more equally unique designs. Most of these structures and systems display a high level of understanding of the properties of the indigenous materials employed, and a deep sense of harmony with the surrounding environment.

Fired Bricks/Bata

Red clay bricks, fired at a relatively low temperature, are a common building material in many parts of Indonesia. Although there are some modern extrusion-process manufacturing plants near Jakarta and some other major cities, most of Indonesia's bricks, called *bata*, are made by small producers molding the bricks by hand. Proximity to a market, light clay soil, and availability of fuel are the only requirements for setting up a *bata* business.

Fuel is the major expense. Rubber wood is a popular fuel where it is available; rubber trees should be cut down when 25 years old and replaced. Acacia and other fast-growing varieties of trees are being planted on land poorly suited for other agricultural purposes in mountainous areas or southern Java, to be harvested and sold as fuel for brick firing. The Department of Industry sold hundreds of kerosene burners to brick producers, correctly claiming that bricks fired with these burners reach higher and more even temperatures. Unfortunately, a few years later, supply problems forced the government to ban the use of kerosene by industry. Burning diesel fuel in these burners caused them to corrode quickly.

Bricks are made from light clay loam. Heavy soils with too much clay shrink, crack and warp in drying and firing. Soils with too much sand produce weak, crumbly bricks.

Commonly, the top 20 centimeters of soil from a fallow rice paddy are stripped off and used for *bata* production. Often banks of rivers or hills are cut away, slowly changing the topography of clay-bearing areas. Alluvial plains provide the best clay for bricks: it has been mixed with sand and deposited by a river.

The clay should be very soft and even for *bata* production. It is mixed with water in a small pit, then mashed by stepping up and down in it until it becomes soft and uniform. Some brickmakers use buffalo, walking them around in a pit filled with clay. It is best if the clay is then left overnight and mashed again the following day, but very few brickmakers bother to do this.

A well-tamped flat area is needed to make the bricks. Sandorash is spread on the surface, and a mold is set in place and tilled with clay. The clay is then smoothed until the tops of the bricks are flat and even with the top of the mold. If care is taken to squeeze the clay into the corners of the mold, to assure that the texture is even throughout with no cavities or impurities,

Bata mold.

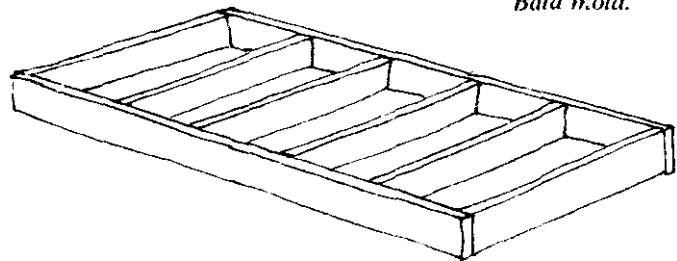

and to smooth the top, the product will be of relatively good quality.

After 1 is 3 days in the sun, depending on the weather, the bricks can be stacked in fence-like rows with spaces for air circulation. Then they are allowed to dry slowly for 3 to 5 weeks, until ready for firing.

The bricks are fired in kilns. The bricks are stacked with small spaces between them to allow the heat to rise. At the bottom of the

stacks are large tunnels for the fires. Typical village kilns hold between 5000 and 50,000 bricks, and require 2 to 4 days for firing. Some brickmakers do not use a permanent kiln, but make a kiln out of the unfired bricks by sealing the outsides and top of the stack with mud and ash. The bricks on the outside of these stacks do not reach high enough temperatures and must be fired again. Proper firing requires temperatures of 800 to 1000 degrees centigrade.

"Red Cement"/Semen Merah

Portland cement is expensive in Indonesia, and often unavailable in villages. Many alternative mortars are used by village masons, the best of which is semen merah, or "red cement." Properly prepared this mortar can be used for two-story houses and even small and medium-sized irrigation dams.

Semen merah is made from pulverized red bricks, burnt lime, and sand. Some building material suppliers now have diesel-powered grinding machines to pulverize the broken bricks they obtain from brickworks and demolition sites, but most villagers still crush their own bricks, pounding them with sticks weighted at one end with a section of iron pipe.

After the brick is thoroughly crushed, the mixture is prepared with the following proportions:

- 1 part crushed brick
- 1 part lime
- 2 parts sand

The lime should be good quality, containing at least 75% calcium oxide. Lime made from coral is unsuitable for making semen

merah. The sand should be fine-grained and free of silt and other impurities.

After the ingredients are combined they are sifted through a wire or bamboo sieve, removing any remaining chunks of brick and thoroughly mixing the ingredients. Enough water is stirred into the mound to form a thick paste, which is applied to the bricks like ordinary mortar. It dries hard in 4 days to a week. If the bricks are clean, the mortar can form a very strong bond. Semen merah mortar resists moisture well, especially if the finished masonry is given a coat of plaster.

Semen merah is too coarse to make a good plaster; buildings are usually plastered with a cement and sand mixture.

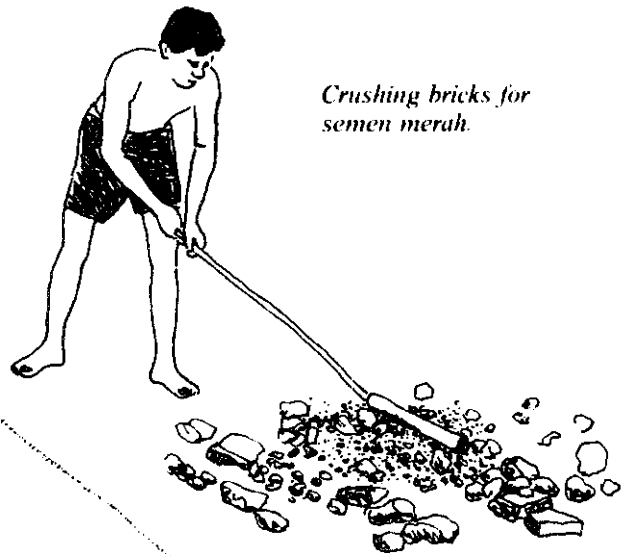

Crushing bricks for semen merah.

Pozzolanic Soil Cement Bricks/Batako

Batako is a type of soil cement brick made of *trass*, or natural pozzolan (a sandy volcanic ash) mixed with burnt lime. In Indonesia, *trass* is found in many volcanic areas, including Java, Bali, West Sumatra, North Sulawesi, and parts of East Nusa Tenggara. *Batako* are already being produced in many of these areas. Some of these areas do not have limestone available for lime production, and *trass* will not harden without the addition of lime. However, *trass* can be substituted for regular sand in concrete and cement mortar. The result will be stronger concrete, or a larger amount of concrete per unit of cement.

Like sand, *trass* is composed primarily of silica and alumina, with traces of iron, calcium carbonate, and other alkali compounds. It is

Batako production



The trass and lime mixture is pounded into the mold with a broad wooden mallet.

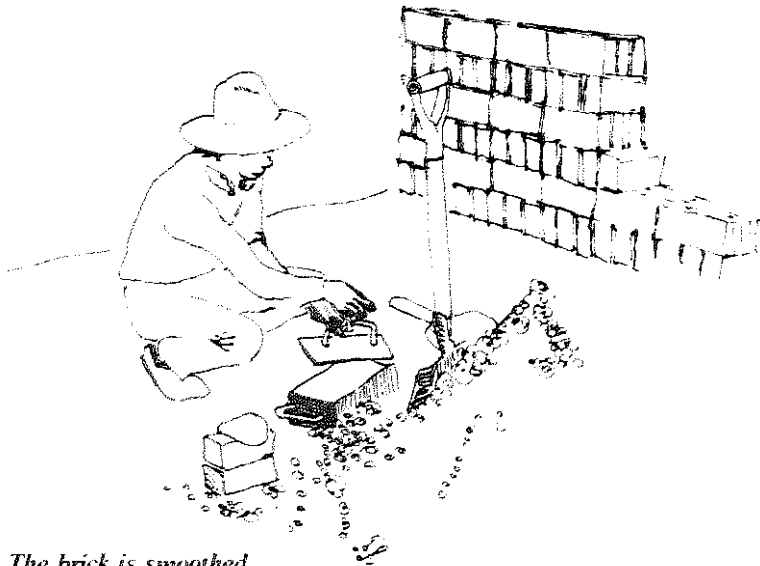

The brick is smoothed with a metal trowel.

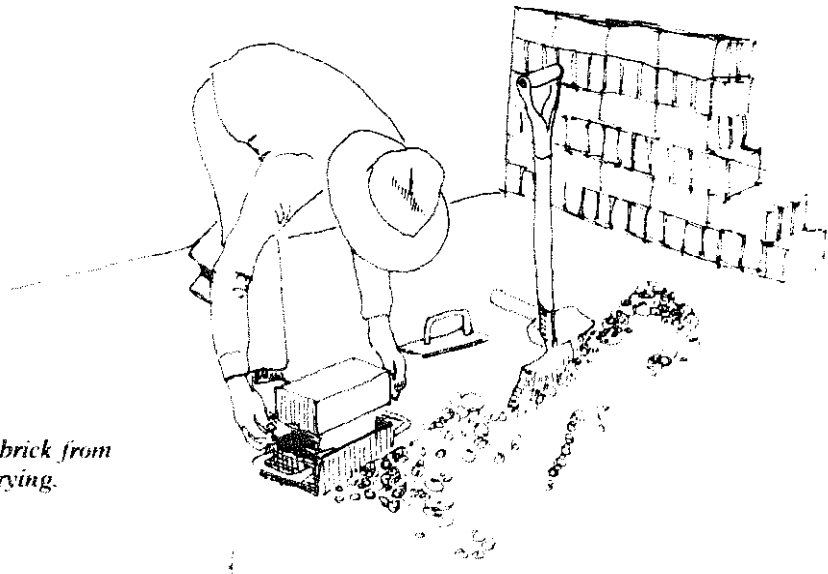

Removing the brick from the mold for drying.

beige or light **grey** in color. This procedure is used to test **trass**:

1. **Good trass should pass easily through** a 2.5 by 2.5 mm screen, leaving no chunks or rocks behind. **Half of** it should pass through a 0.21 by 0.21 mm screen.

2. Mix 2 parts **trass** with 1 part lime and 1 part water, stirring until it is thoroughly mixed.

3. Place this mixture in a bucket or other container, then cover it with a few centimeters of water.

4. **In 3 days**, the **mixture** should have hardened into the shape of the mold.

The following process is used to produce **batako**:

1. A part lime is mixed with 3 to 5 parts **trass**, then sprinkled with water and stirred until it forms a crumbly, **homogenous** mass.

2. **The mixture** is scooped into a box-shaped metal mold open on the top and **bottom**.

3. The mixture is pounded with a broad wooden mallet until compact.

4. The **top** of the brick is smoothed with a

metal trowel.

5. The brick is removed by lifting the mold and brick onto a wooden block and pressing the mold downward, leaving the brick sitting on top of the block.

6. **The bricks** are stacked with a small space between them and allowed to dry for about two weeks.

In different areas, **batako** are made in different sizes and shapes. Two common sizes are 10 by 20 by 40 cm, and 12 by 15 by 35 cm. A few companies are now using mechanical presses to make strong pressed **batako** with holes for reinforcement with mortar or iron bars.

Batako are not as strong as fired bricks and cannot be used for structures requiring high strength. However, they can be used to build much more permanent houses than bamboo or wood, at just a fraction of the cost of fired bricks or concrete. The mortar and plaster used is often **trass** and lime, mixed in the same proportions as the **batako** mixture.

Wood and Bamboo Preservation/ Pengawetan Kayu dan Bambu

Indonesia's damp tropical climate causes rapid decomposition of organic materials. **In** a tropical rain forest, this rapid decay, aided by a profusion of insect, fungus, bacteria and parasitic plant varieties, assures the rapid return of nutrients to the soil, a vital step in the life cycle of the forest. But for **construction in** the same region, this decomposition process becomes a serious **problem**. When wood and other plant products such as bamboo and palm leaves are used for construction, they must **first** be treated to assure that they will be resistant to **rot**, termites and **boring** beetles. Indonesian **villagers** found the appropriate method in nature many centuries ago. Nearly **all** wood and bamboo used for building in Indonesia is treated by a very simple process before use.

Freshly cut wood or bamboo is submerged in water for at least three months. Any body of **fresh** water will do, but ponds and lakes are preferable to rivers. The wood is held down with stakes and lashes, and in some areas it is also covered with a thick layer of mud. **After**

three **months** or longer, the wood gives off a rotten urine-like stench. The wood is then air dried until it can be sawn into posts and planking. The process is identical for bamboo. If **bamboo** strips are needed, the bamboo should be split before submersion: this accelerates the process by two or three weeks.

Unfortunately, this process darkens the wood and subdues the grain pattern of certain decorative species. It is therefore seldom used with wood intended for fancy trim or furniture.

The bases of posts, even if set upon foundation stones well above the ground level, are the first points to begin rotting. These bottom ends can be soaked or painted with used motor oil, **creosote**, tar, or other **petroleum-based** preservatives. With the possible exception of **ironwood**, **no wooden** post should be sunk into soil in tropical areas: it will quickly **rot** at the soil line.

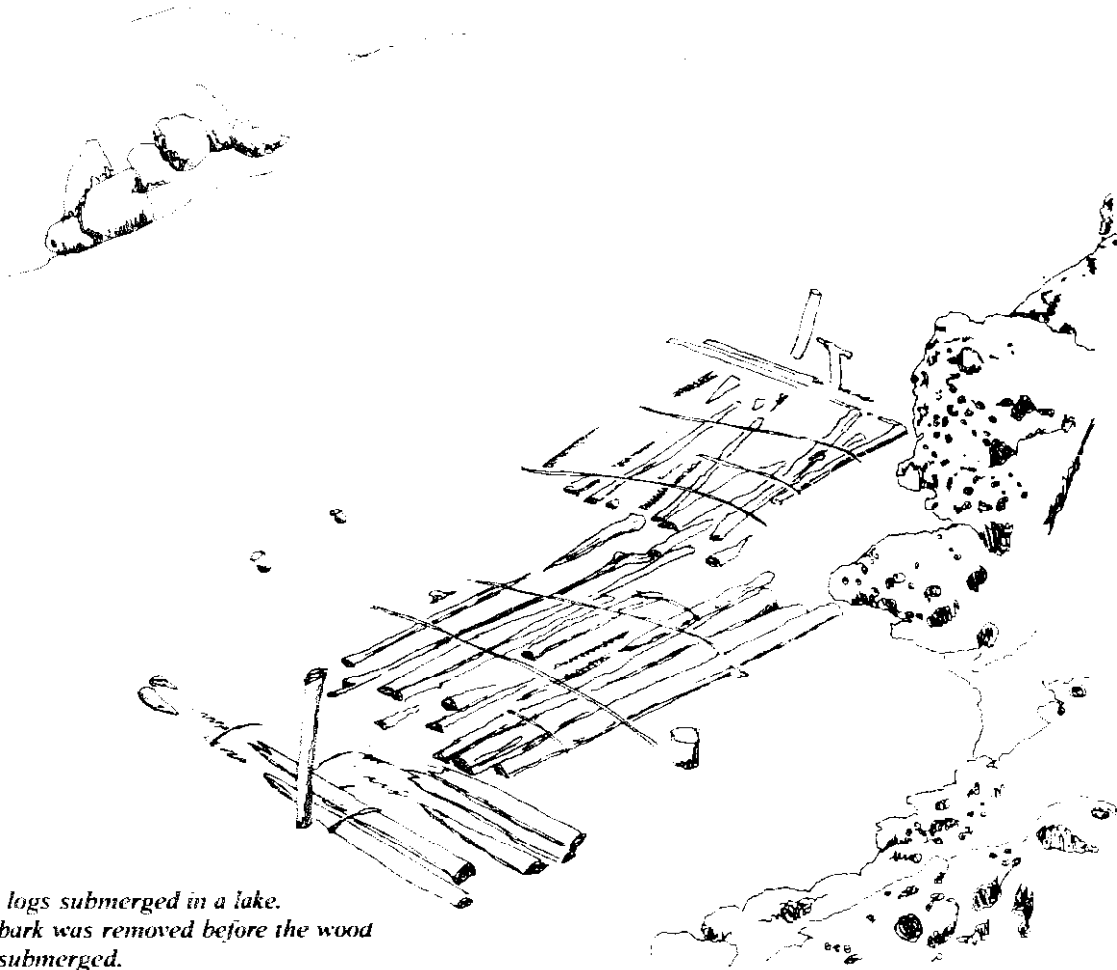

*Teak logs submerged in a lake.
The bark was removed before the wood
was submerged.*

*Bamboo strips air drying after
3 months under water.*

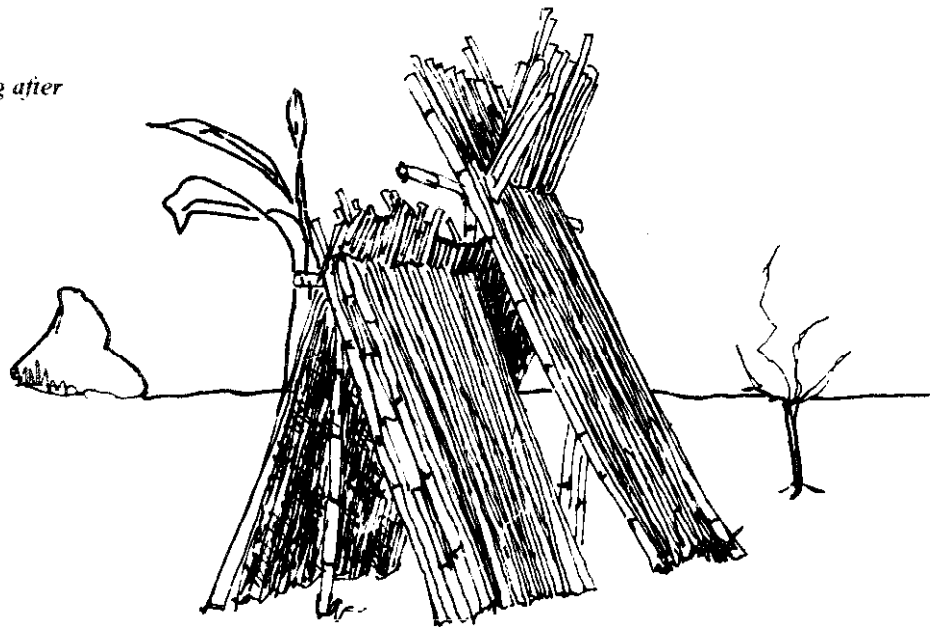

Adze/Wadung

The adze is one of the most ancient tools known to man. Although Indonesia now possesses a large number of large and small modern sawmills, a great deal of wood is still hand cut, and the adze (*wadung*) is an important tool for carpenters and woodsmen alike. Other than the use of strong steel for the blade, the *wadung* has changed little over the centuries. It consists of 3 parts:

1. The blade is made of spring steel by local blacksmiths. The spade-shaped blade is thick at the top, tapering gradually to a sharp edge. Blades range in width from 6 to 15 cm. and are about 15 to 30 cm long, including the stock. The stock has a square cross section, and also tapers from 3 by 3 cm at the end near the blade almost down to a point. Because the stock is square and tapered, the blade can easily be removed, rotated 90 degrees, and reattached, allowing the *wadung* to be used as an axe.

2. The handle is made from a short stout hardwood pole, about 70 cm long with a diameter of about 4 to 6 cm. The blade end is rectangular.

3. A strong headpiece fastens the blade to the handle by forming a tapered cavity the same

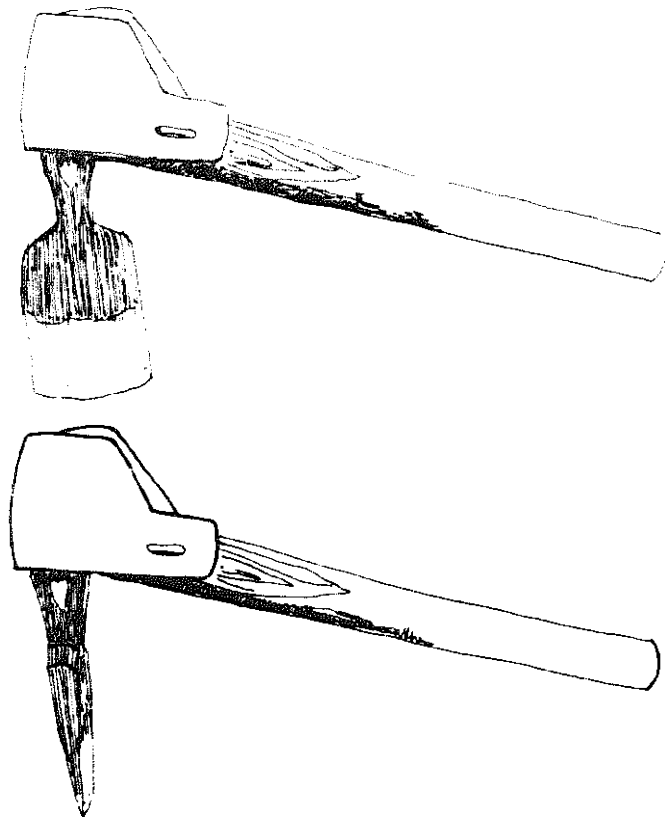

shape as the blade stock. The headpiece is made either of heavy sheer iron or raw buffalo skin which is soaked, shaped, stitched, then allowed to shrink to a tight fit on the blade stock.

For chopping trees or cutting logs into sections, the blade edge is set parallel to the handle and the *wadung* is used as an axe or hatchet. To square logs or shape beams, the blade is removed and replaced after rotating it 90 degrees, so that the edge is perpendicular to the handle. The woodsman stands over the log with one foot on each side, and chops a layer off the top of the log with a motion similar to hoeing. As each chop cuts off a large chip of wood, the craftsman breaks it off by pulling the handle towards himself and down, rather than pushing away and forcing the end of the blade upward. A skilled craftsman can make rectangular beams of very regular shape and texture.

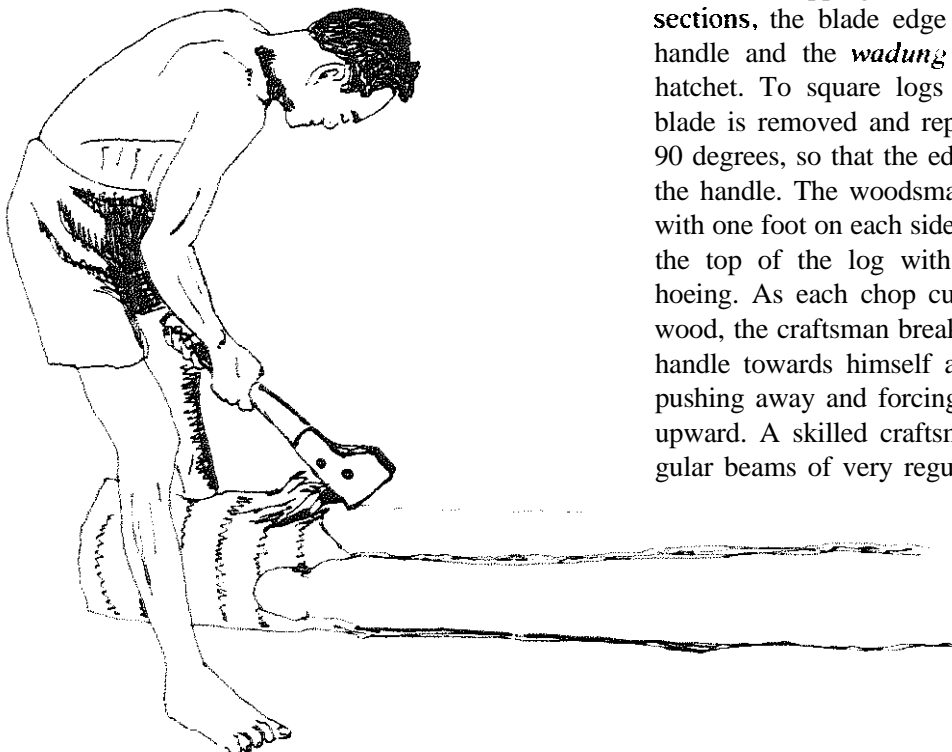

Alang-Alang Grass Roof/ Atap Alang-Alang

Alang-alang grass is a pernicious weed which covers millions of hectares in Indonesia. It is especially prevalent in areas which have been used for slash and burn agriculture. So far, only the Balinese have figured out any constructive use for this tenacious grass: they use it to make attractive and long lasting roofs for their houses and rice barns.

Sheets of *alang-alang* roofing are prepared by folding the blades of the dried grass over a strip of bamboo about 1½ to 2 meters long. The grass is about 60 cm long; when about 15 cm of the stem end is folded over, it makes the sheets of grass roofing about 45 cm by 2 meters. The folded grass is tied onto the bamboo slat with string made from bamboo or other available material.

The roof construction uses bamboo rafters set about 15 to 30 cm apart. Starting from the bottom, the sheets are lashed onto the rafters at close intervals, forming layers. By spacing the tops of the sheets only about 6 to 7 cm apart, a

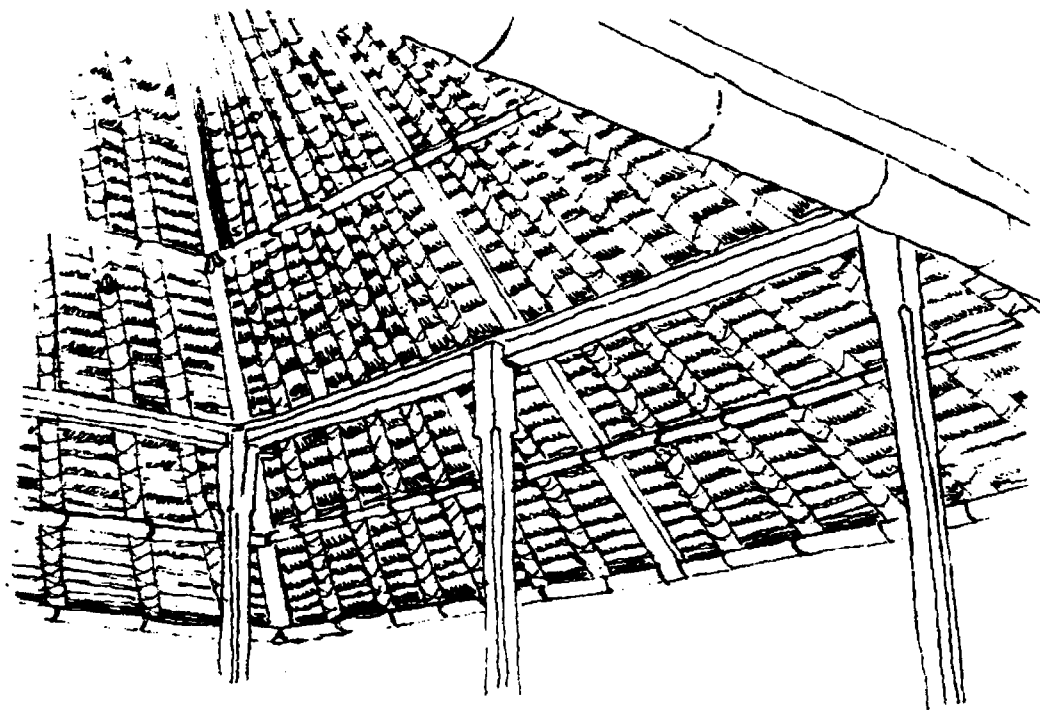
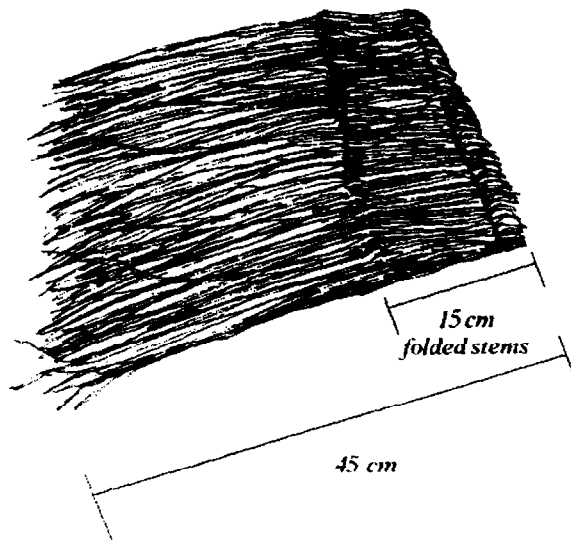

dense roof 10 to 20 cm thick is created. The corners and peak are protected by arc-shaped roof tiles which prevent rain water from entering at these points.

If the building is located in a sunny spot where the roof can dry out between rains, this type of roof can last up to 50 years. In shady locations where the roof stays damp, it will last only about 10 to 20 years.

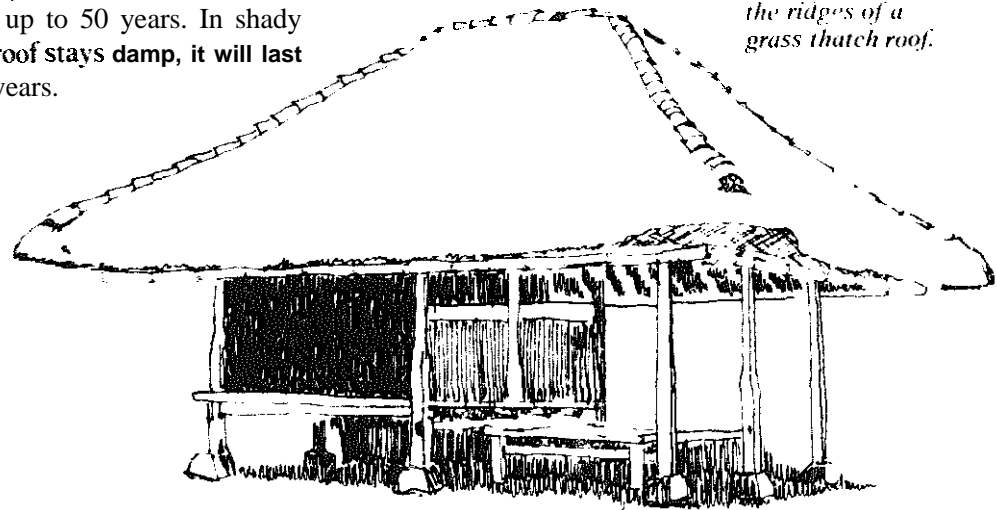

Roofing tiles protect the ridges of a grass thatch roof.

Bamboo Reinforced Cement/

Bambu Semen

For several decades, many people of West Sumatra and a few people in West Kalimantan have used cement plaster over plaited bamboo for wall construction. Besides being much cheaper than masonry construction, this technique has other advantages: it is somewhat flexible, making it stronger in West Sumatra's many earthquakes, and it is lighter, reducing the chance that the house will sink into Kalimantan's soft mud.

Water-treated bamboo slats about 6 to 8 mm thick and 2 to 3 cm wide are plaited, with the vertical pieces spaced 10 to 20 cm apart and the horizontal pieces almost touching. The bamboo is plaited so that the smooth outside and rough inside surfaces alternate to help the cement adhere well.

The connection between the plaited bamboo and the wooden uprights must be strong. Usually a thin board is plaited into the ends of the bamboo, and this board is nailed onto a post. This is somewhat of a problem, as cement does not adhere well to wood, and therefore the edges of the plastered section

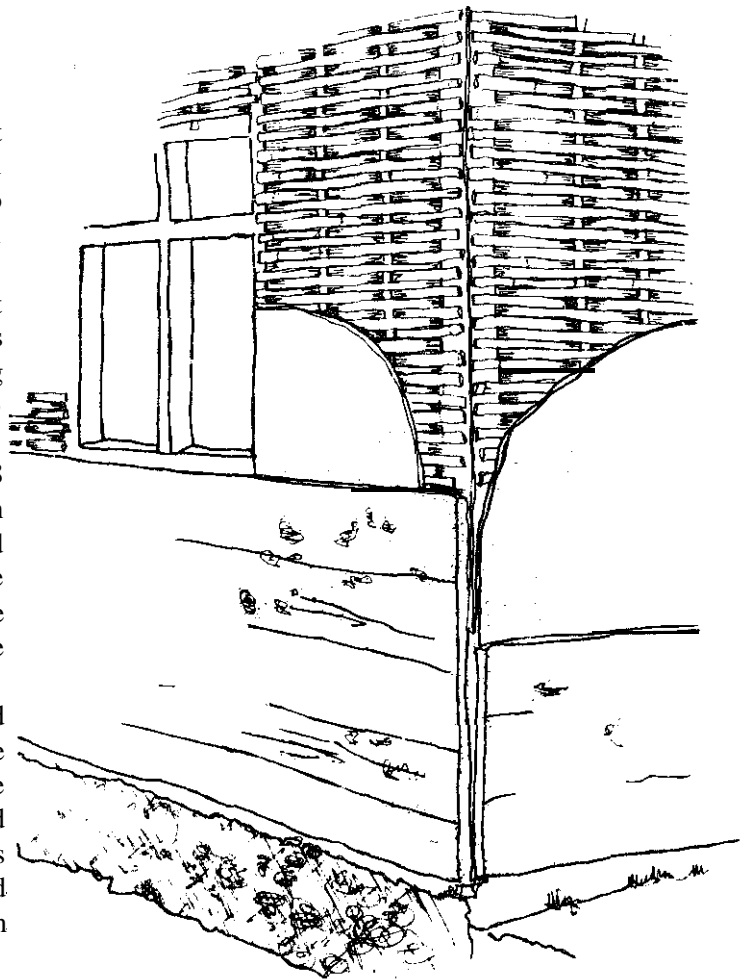

tend to crumble off.

The plaited bamboo sections are separated by the posts and are not directly connected to each other, in an effort to localize damage in the event of a quake or settling.

One to two cm of cement-sand plaster is spread on one side of the bamboo and smoothed. The mixture is about 1 part cement to 10 parts sand; lime is not used. After the first

side has hardened, the other side is plastered. The finished walls are 3 to 4 cm thick.

In West Sumatra, the bottom .61 meter portion of the walls is made either of bricks and mortar, or more commonly, river rocks and concrete, which are cast in wooden forms and then plastered. In Kalimantan, the entire wall is made from bamboo reinforced cement.

Acehnese House Design/Rumoh Aceh

Traditional houses in Aceh, like those in most of Indonesia's outer islands, are built on stilts. The houses have far fewer insects that way, and the cool shady space under the house is used for visiting, handicrafts, food preparation, etc.

One of the major advantages of putting houses up on stilts is improved cross-ventilation. The Acehnese take this one step further by building their houses with slatted floors. Thin strips of tough, springy *nibung* wood, about 1% by 5 cm, are used to make the floor. *Nibung* is a local variety of palm tree, with fibrous and very strong outer layers. The strips are nailed or tied to joists set about 40 cm apart. A gap of about 1 cm is left between each strip.

The result is a smooth and somewhat springy floor. Usually, plaited *ikar* mats are spread on top of it. Cool air comes up through the floor to replace the heated air escaping through the eaves, windows and roof, with the result that the inside of traditional Acehnese houses is the most comfortable place to be in that hot area. Slotted floors are also very easy to keep clean.

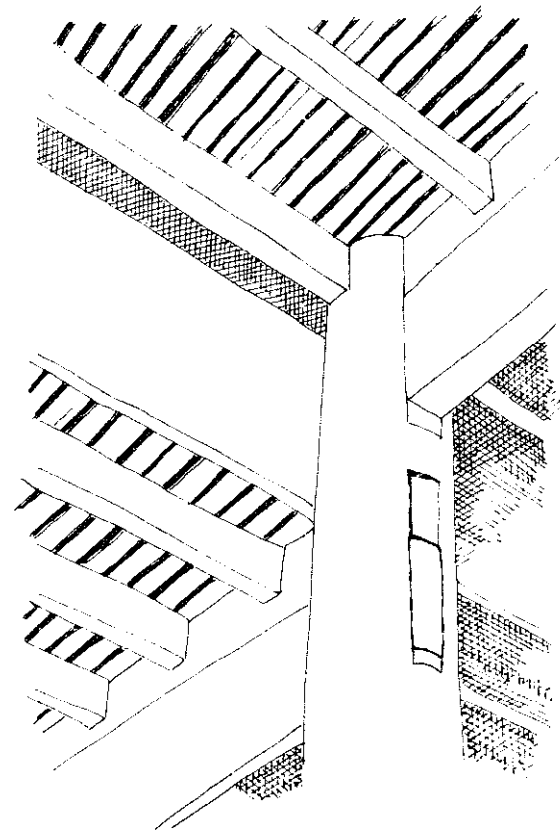

Bamboo Implements/Perkakas Bambu

Bamboo is one of **the** most useful plants known to man. An attempt to **list** all of the uses of bamboo in Indonesia's villages would fill several volumes this size. Practically all aspects of the lives of Indonesian villagers involve the use of something made from bamboo.

The largest members of the grass family, there are dozens of **varieties** of bamboo growing throughout the islands, some reaching heights of over 10 meters and base diameters of 15 cm or more. From an early age, Indonesian village children learn to cut, split and join bamboo, often making their **own** toys. This is one of the most important skills **they** will learn.

There are hardly any buildings in the country which **have not used** bamboo in their construction; even Jakarta's **modern** skyscrapers **were** built with bamboo scaffolding. And practically no household is without some bamboo tools in daily use. For instance, a simple bamboo folding clothesline is used to hang out the wash. It can be folded up for storage between use.

A bamboo rack is a simple and attractive way to store all of the kitchen implements in a place that is dean and convenient. Any villager with a knife can produce such a rack in just a few hours.

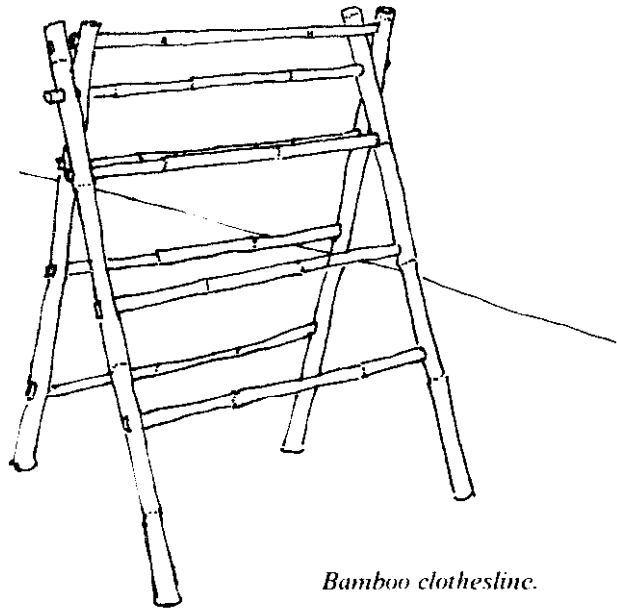

Bamboo clothesline.

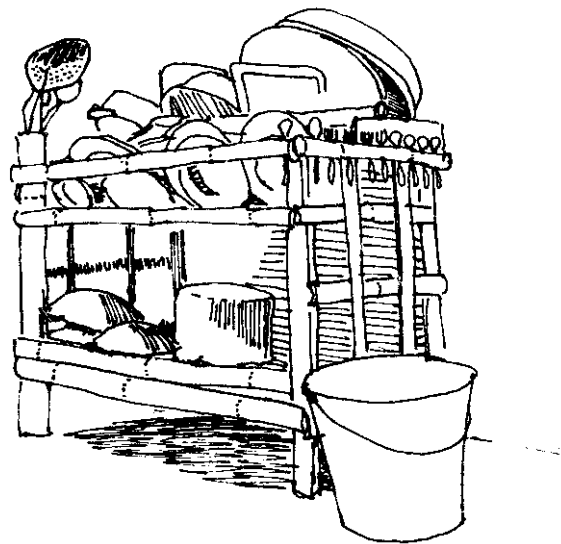

Small Industries, Handicrafts and the Informal Sector/ Industri Kecil, Kerajinan Tangan dan Sektor Informal

It has often **been** presumed that the economies of Indonesia and **other** developing countries are divided into two mutually exclusive **sectors**: the small "modem" sector composed of capital intensive industries, **plantation** operations and business enterprises, and the **traditionai** agrarian sector, a **rural** society with traditional farmers, artisans and craftsmen that needs only small amounts of hard cash to **buy** such items as soap, needles, matches, and an occasional bicycle or transistor radio.

Such an analysis ignores the existence of a lively and vital intermediate sector, found in both urban and rural areas, supplying services and **manufactured** products to people at all levels of society and even serving the needs of the growing "modem" **sector**.

Statisticians still **call 80%** of Indonesia's people "farmers." **In** fact, these people call themselves farmers only because they have some connection to the land, either owning a **small** plot or periodically working a plot for someone else. **Actually**, most heads of households can claim **three** to five outside **income**-earning activities, which **often** bring in more income than their farms. And as growing numbers of rural Indonesians farm ever smaller plots of land, more and more people seek their livelihoods in non-farm enterprises.

As this **sector** grows, awareness of its existence is **also growing**. *The 1973 Handbook of Indonesian Statistics* reported that only 1.4 million people **were** involved in the informal sector. **In** 1977 the Minister of Industry raised that figure **to** 11 million. International Labor Organization **figures** are as high as 17 million. **In** a labor force of about 50 million people, these numbers demand greater attention.

The **enterprises found in** Indonesia's intermediate **sector** do not necessarily have the characteristics generally ascribed to the informal sector: lack of organization, small capital investment, low **level** of skills, predominance of family operation, freedom from regulation or official ties, impermanent **location**, and no use of formal financial support networks such as banks or credit union. In fact, these informal businesses may employ sea-

sonal labor up to **100** people, have **fixed** workplaces and equipment, produce high quality products, receive orders in the millions of **rupiah** (thousands of dollars), and have connections with a variety of "formal" enterprises (though frequently through unofficial channels). In many **cases** these small enterprises pay their workers higher wages than those in the "modem" manufacturing sector. The ability to respond and adapt assures the viability of these informal enterprises; they must respond to market conditions as they **are** beyond the reach of government sanctions or assistance.

The technologies employed by many of these enterprises embody the philosophy of the appropriate technology movement: they **are** small scale, labor intensive, consume small amounts of energy, are simple and **inexpensive**, and are designed, produced and maintained using local skills and materials. These entrepreneurs borrow and adapt technologies imported by the modern sector, improve on traditional tools, **and often invent new** tools and processes suited to their specific needs, demonstrating through innumerable examples the informal sector's ability to perceive real needs and opportunities and react accordingly.

Recycling/Guna Ulang

One of the most evident types of informal sector productive activity, in Indonesia and nearly all developing countries, is the re-use of waste products for the manufacture of consumer goods. Both the waste products from the modern industrial sector, and the broken discarded goods of the urban population go back into production, or are recycled. For those who cannot afford to buy imported manufactured goods, local ingenuity provides alternative products made from materials which would otherwise be thrown away.

The majority of Indonesians are poor and most are not fully integrated into the monetized economy. In the village economy, the small supply of capital places severe limitations on both production and consumption patterns. Yet changes in living conditions, such as increasing urbanization and the availability of consumer goods, are creating new demands for both consumer and production goods, and low-capital business and employment opportunities.

Recycling industries tend to be small, diverse, and difficult to count, tax or control. This is not to say that they are not highly organized. But they hardly affect the GNP and, as a result, have been largely neglected by the government. Members of the administration do not buy goods from these industries, in fact often do not seem aware of their existence, or the existence of that majority of the population to whom they cater. Mayor Cokropranolo of Jakarta, during a visit to a sector of that city teeming with small informal businesses, said that "the best thing that we (i.e. the government) can do for them is leave them alone." indeed, the only major official attention paid the recyclers is from the police, concerned about those who steal their raw materials.

Waste material suitable for recycling is naturally concentrated in urban areas where both the capital intensive industries and the wealthy consumers are located. Imported industrial plants usually use production techniques which create wastage which is not profitably usable, for technical reasons, within those industries. Broken equipment and discarded machine components also become raw mater-

ials for the recycling industries. The third and greatest source of raw materials is the trash of wealthy consumers. The recycling industries which produce implements for the poor are paradoxically dependent upon the consumption of the rich.

Scavenging supports tens of thousands of people in Indonesia's major urban centers, who search every street, collecting everything from newspapers to automobile batteries to cigarette butts. The manager of a huge imported trash processing and composting plant in Surabaya complains that the trash is already picked so clean by the time it is delivered to his plant that most of his expensive machinery is rendered useless.

Much of the scavenged material is sold to middlemen who channel it either to recycling craftsmen (who make it into cheap implements) or back to the big factories where paper, plastic and scrap iron can be reprocessed and included in the manufacture of new goods. An outsider's first impression of Indonesian recycling is likely to be that of destitute people coming to the cities desperately trying to eke out a living by picking through garbage. A closer examination reveals an efficient and organized business that has close ties with the modern industrial sector. The scavenging business is at the same time informal and sufficiently complex to defy easy comprehension by outsiders.

That portion of the scrap which finds its way to craftsmen for conversion into implements and consumer goods for the poor, often ends up as surprisingly elegant products. Indonesia, like other Asian countries, has a very long craft tradition. Whether working with ebony or silver or discarded tin cans, the Indonesian craftsman has an understanding of his material which shows in the finished product.

Iron is the material recycled in the greatest amounts. Blacksmiths used to prefer rail from the railroads, but now as more commerce travels by highway, broken springs from trucks, buses and automobiles supply this industry with its raw material. Sheet iron, especially from oil and asphalt drums, is always in great demand. Used tires, a major disposal problem in industrialized nations, command a high price in Indonesia. Paper is collected and

re-used. sold either to paper factories to make newsprint, or to vendors to wrap their wares. Broken plastic wares are collected and sold back to the casting factories to mix in with new raw material for the production of new buckets, scoops and brushes which will soon return to

the factory again. Perhaps the most fascinating of all the scavengers and recyclers are the wandering *loak* merchants. They collect and sell everything from used shoes to bottles, broken toys, and alarm clock parts: and they support their families doing it.

Used Tires/Ban Bekas

Used tires present a formidable disposal problem in Western nations. Not so in Indonesia. Totally bald tires still command a high price here. They are used to make a variety of consumer items. Recycling tires is an industry which employs thousands in Indonesia, and the products are found in nearly every home of the poorer sectors of society. Rubber tire goods are

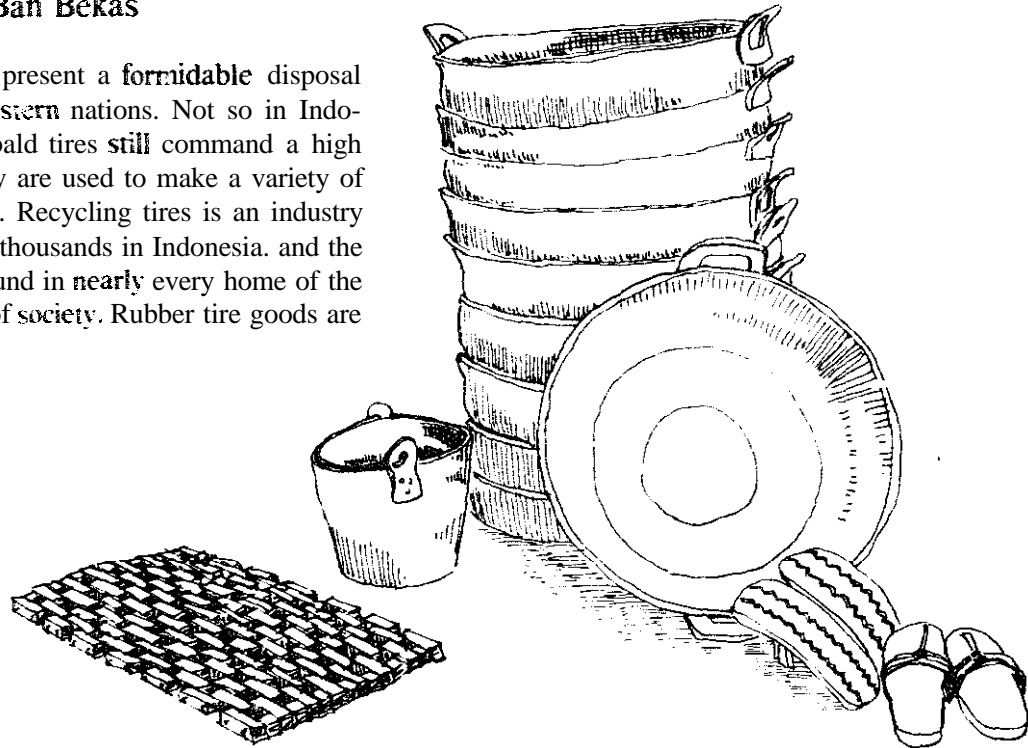

less expensive than their plastic counterparts, and usually much sturdier.

Common items produced from used tires include sandals, soles for shoe repair, buckets, wash basins, flower pots, doormats, rope for lifting buckets from wells, harnesses and straps for draft horses, shoes for the oxen that pull carts on paved roads, and springy straps for supporting chair cushions.

The tires are cut into different sections for different purposes. The wire bead is cut off and burned and the wire is sold for scrap. The sidewalls are used for making buckets, tubs, rope and straps, and the tread is used for sandals, soles, and "tires" for wooden cart wheels. Nothing is wasted.

The medium sized blunt-shaped knives used for cutting the rubber must be kept very sharp. The craftsmen keep a tine-grained

sharpening stone next to them, taking a few strokes to hone the edge every minute or two as they work. Some craftsmen lubricate the cut with water; most do not.

The parts of the products are fastened with rivets or nails pounded through and bent so they cannot pull out. Buckets and tubs are sealed, using either asphalt or paint as a glue.

The tool for cutting ropes and straps is a short bench with a knife blade and an iron rod implanted near the upper end, about one cm apart. The lower end is weighted or fastened to the floor. To adjust the size of the gap between the blade and the rod and therefore determine the width of the cut, a wooden wedge is pressed between the blade and the rod, near the top of the blade. The blade is pounded into the wooden block to hold it in place (point down). The O-shaped tire sidewall is cut into one long

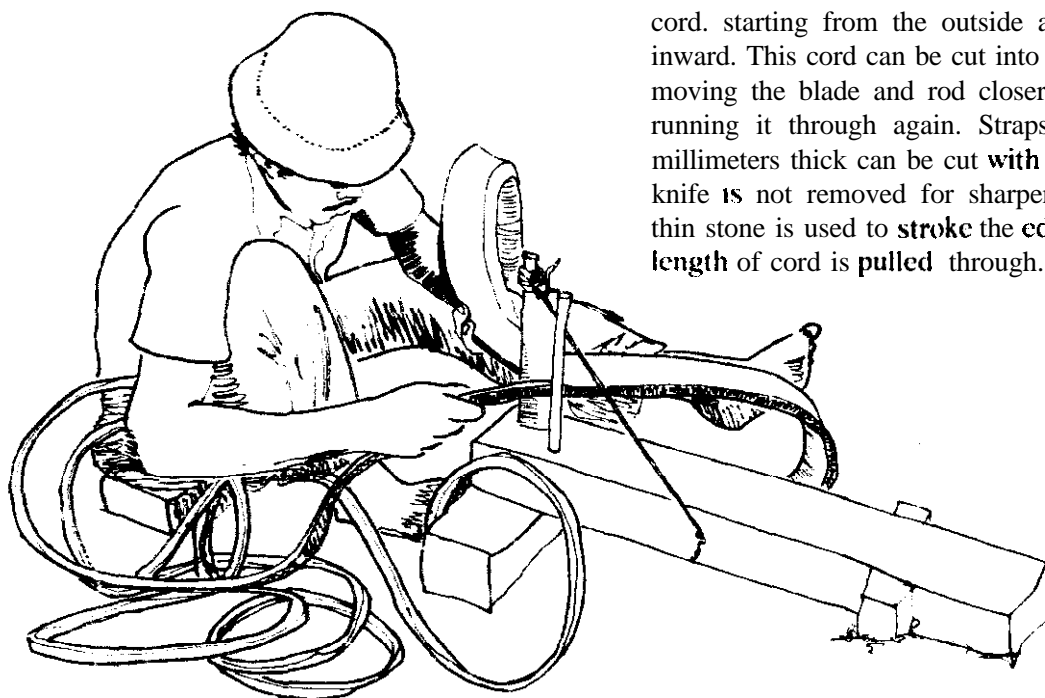

cord, starting from the outside and spiralling inward. This cord can be cut into thin strips by moving the blade and rod closer together and running it through again. Straps only a few millimeters thick can be cut with this tool. The knife is not removed for sharpening; a small thin stone is used to stroke the edge after each length of cord is pulled through.

Lightbulb Wick Lamp/Lampu Tempel

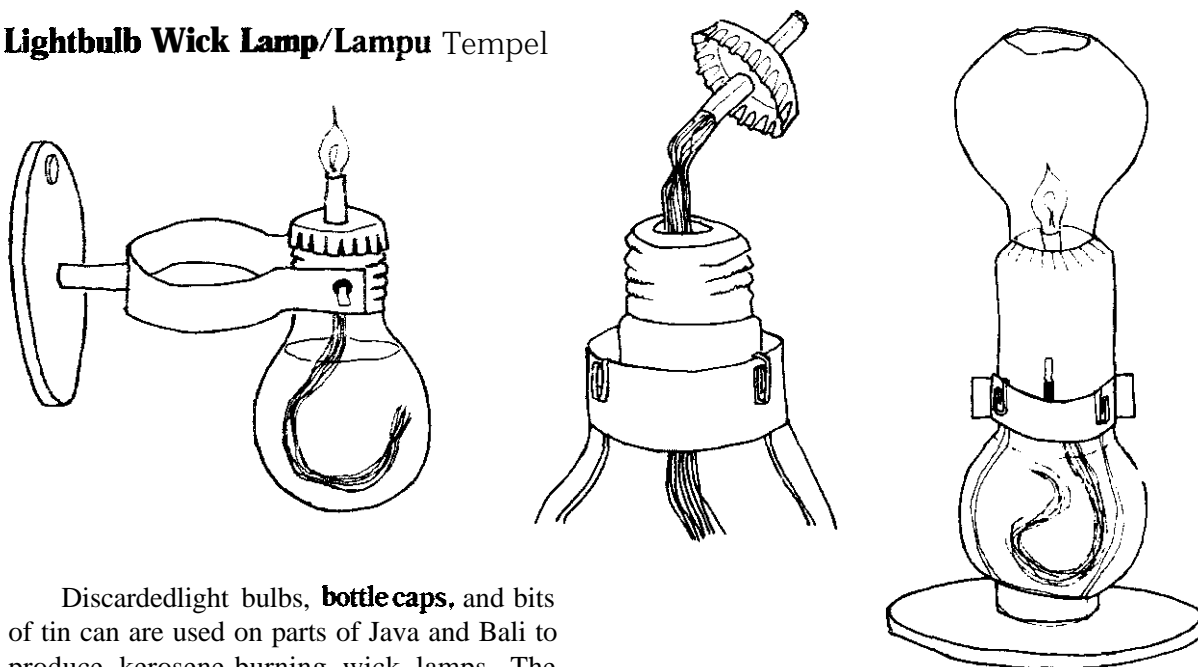

Discarded light bulbs, **bottle caps**, and bits of tin can are used on parts of Java and Bali to produce kerosene-burning wick lamps. The socket end and filament are carefully broken out of the light bulb, leaving a hole to put in the **fuel and insert the wick. Loose cotton cord** of the type used as wick material in industrially made kerosene stoves is passed through a soldered **tube** which passes through a bottle cap. Unfortunately, this arrangement allows the wick to be adjusted only by pulling up the cap and pulling or pushing the wick to the proper height. Windscreens for the lamps can be made either

from light bulbs with both ends cut out, or, more commonly, from small plastic cream detergent tubs. **Two or three** small air inlets cut at the base of the windscreen help cut down on the smoke and soot from the kerosene flame. Operating the **lamp with** the wick pulled out too far creates a pulsating flame which many vendors use to call attention to their wares in night markets.

Fluorescent Tube Wick Lamp/ Lampu "Neon"

Delicate and attractive wick lamps can be made from the thin glass of used fluorescent light **tubes**. **When** the ends are removed and the white **powder** washed **out**, the glass is **quite** thin and clear. Shaping the glass by softening it with heat and then blowing and twisting it into lamp parts requires a high degree of skill and delicacy.

The **lamp** consists of four parts: a cotton wick of the type used for kerosene stoves, a combination fuel tank and base, a wick **holder** and a chimney glass. The base is either a **flat-bottomed** glass sphere or double sphere with a narrow neck on top, opening to a larger cylindrical mouth with a decorative fluted edge. The wick holder is a **small** diamond-shaped piece of the **same** thin glass stock with small holes in each end which tightly hold the wick. It sits in the neck of the base, a short section of wick protruding out of the top for the flame, and the remainder of the wick dropping out the bottom into the fuel tank. The vase-shaped chimney glass sits loosely inside the mouth of the base, so that air for combustion can be drawn in. The top edge also features decorative fluting.

The shapes are **formed** by heating the glass over a small flame, then twisting the glass to narrow and close off sections, or blowing on the end to cause the softened section to bulge out. Also, small **wooden** or bamboo implements are used to make indentations and fluted edges. The hot glass is **cut** either with a hot knife or a sharp piece of bamboo. Extreme delicacy is required for this work, but the material is cheap and abundant and the rewards sufficient; these lamps sell for as much or more than commercially produced wick lamps.

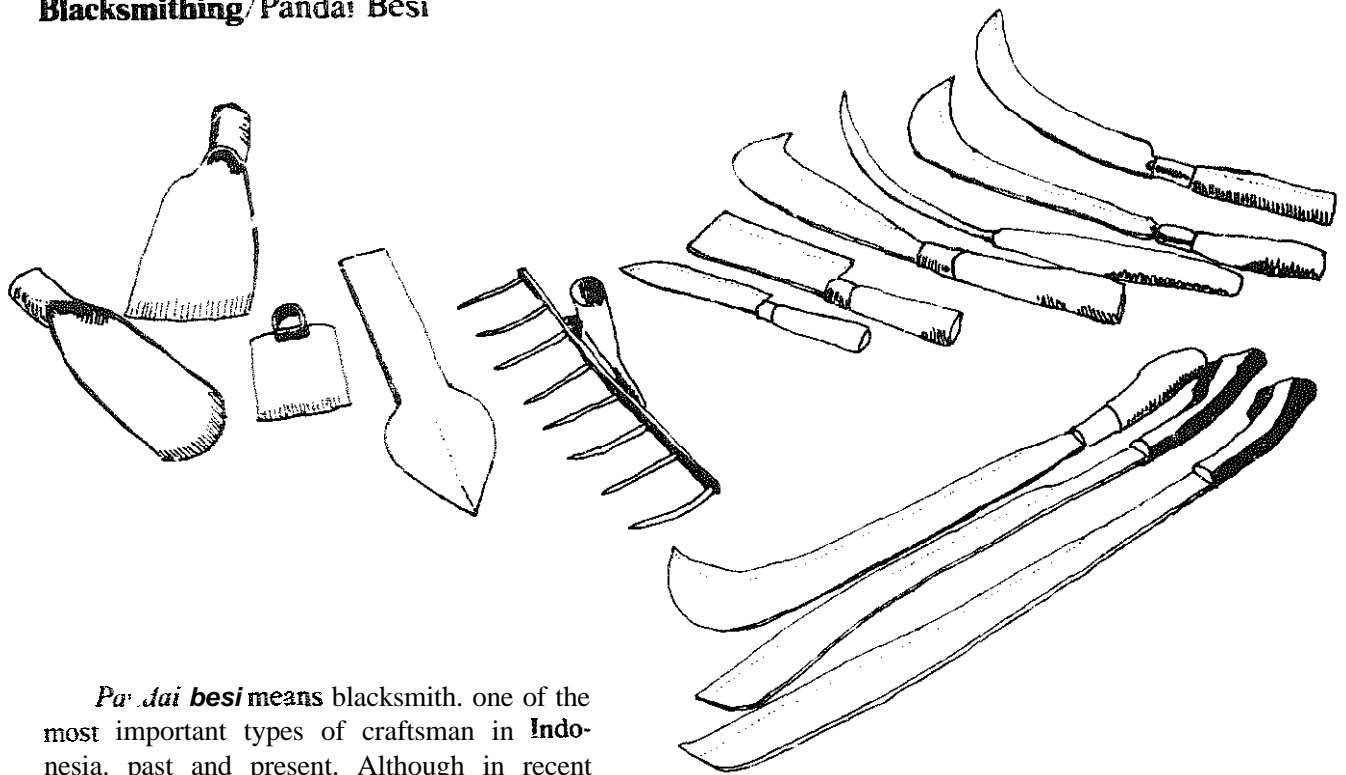

Blacksmithing/Pandai Besi

Pandai besi means blacksmith, one of the most important types of craftsman in Indonesia, past and present. Although in recent years factory-made competitors to blacksmiths' products have appeared on the market, the traditional goods continue to sell well because people trust them and know that the product can be repaired by the local craftsmen who made them.

Smithing materials, techniques and final products vary little throughout Indonesia, although almost every area has a special favorite shape of knife or machete, and boasts that their iron products are superior. The art is perhaps most ancient in Sulawesi; in fact, both the current name and the old Dutch name Celebes are mispronunciations of the Bugis term for ironworking.

These days, automobile and truck springs are the most common raw material, though railroad rails are also popular and a few items such as scissors require low carbon softer steel. The tools and techniques used are as old as the art itself. The iron and steel is heated in charcoal fires with forced air from one of several types of pump. The pieces are cut and shaped on crude iron anvils, usually a short section of railroad rail fastened to a block of wood, using hammers and cutters with designs unchanged for centuries. If the usage of the finished product requires, the edges can be hardened,

disepuh by heating them to red heat and then quenching them in water or oil. Hardness ranges from malleable to springy and brittle.

Generally, the quality of blacksmiths' products in Indonesia is good. Even though this craft now faces stiff competition from the modern manufacturing sector, it is destined to continue thriving in Indonesia for a long time.

Fan-Type Forge Pumps/Ububan Putar

Blacksmiths and other metal workers use a charcoal fire with forced air to heat their metal. Throughout Indonesia, many different types of air pumps are used for this purpose. A type that has recently gained popularity in Java and Bali uses a band cranked rotary fan. This pump is called *ububan putar*. There are several designs, all similar in form and function. They have 5 components:

1. The drive wheel and crank assembly is made from a bicycle wheel set on a stationary axle. A wooden or metal pin attached to the spokes serves as the crank.

2. The power is transferred from the crank wheel to the fan assembly by a rubber belt cut from an old automobile tire, stitched or lashed into a loop of the appropriate length.

3. The fan chamber is a cylindrical or square sheet iron or wooden box. Air enters a hole at or near the center of one side of the chamber, and blown air passes out a passage (usually a sheet metal cylinder) connected to the outside of the chamber.

4. The fan has 4, 6, 8 or 16 sheet metal blades radiating from the axle. These blades are about 8 to 10 cm wide and 10 to 20 cm long. The axle fits into holes in the center of both sides of the fan chamber. One end of the axle extends out several centimeters to connect with the belt. Often it has flanges to hold the belt in place, and

a piece is added to increase the axle diameter and increase the belt traction.

5. The outlet directs the pumped air into the base of the firebox, the shape of which is determined by the type of work done. Crucibles for melting metal for casting require deep cylindrical tire pits, while blacksmiths require a broad open space around the fire to lay the objects to be heated across or into the center of the tire.

continued...

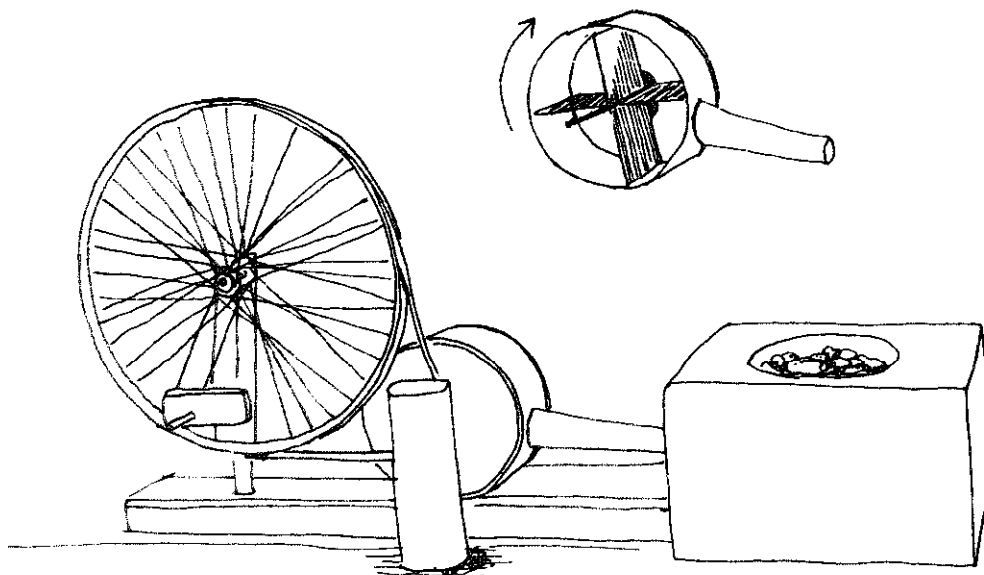

Blacksmiths usually place their *ububan* and firebox adjacent to a small pit with an anvil. In this manner the operator can turn the crank while sitting with his feet in the pit, then take out the red hot piece and hold it over the anvil to pound without changing position. Blacksmiths usually work in pairs, one cranking the *ububan* and holding the piece while his partner pounds, or visa versa. In casting workshops, the *ububan* is located a few meters away from the workspace (packed earth or a brick floor) where the casting is done once the metal is molten. Finishing work is done away from the heat and sparks of the firebox.

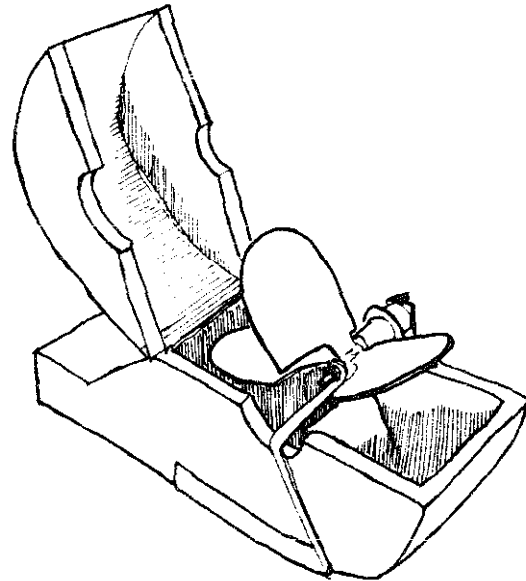
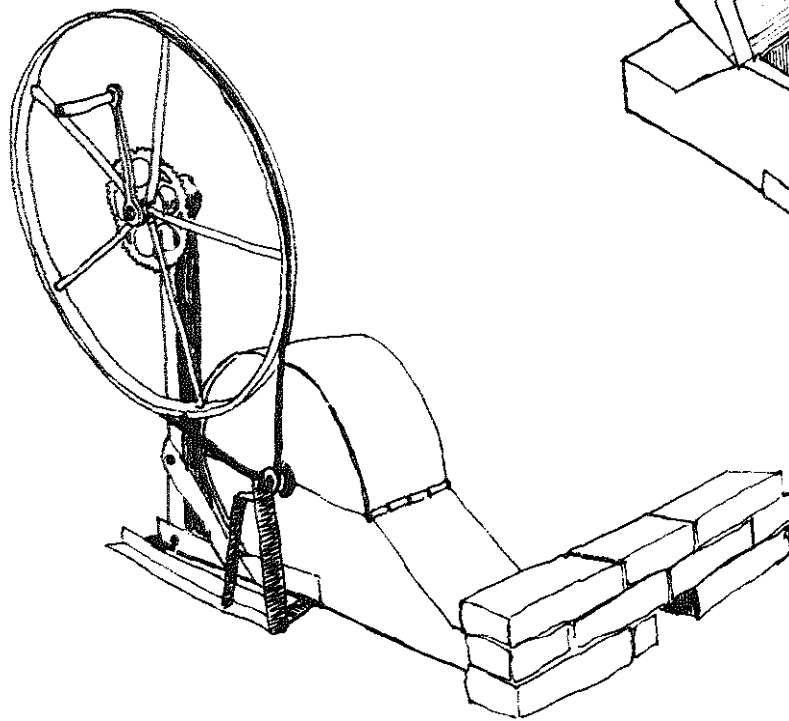

Double-Acting Piston Forge Pump/ Puup

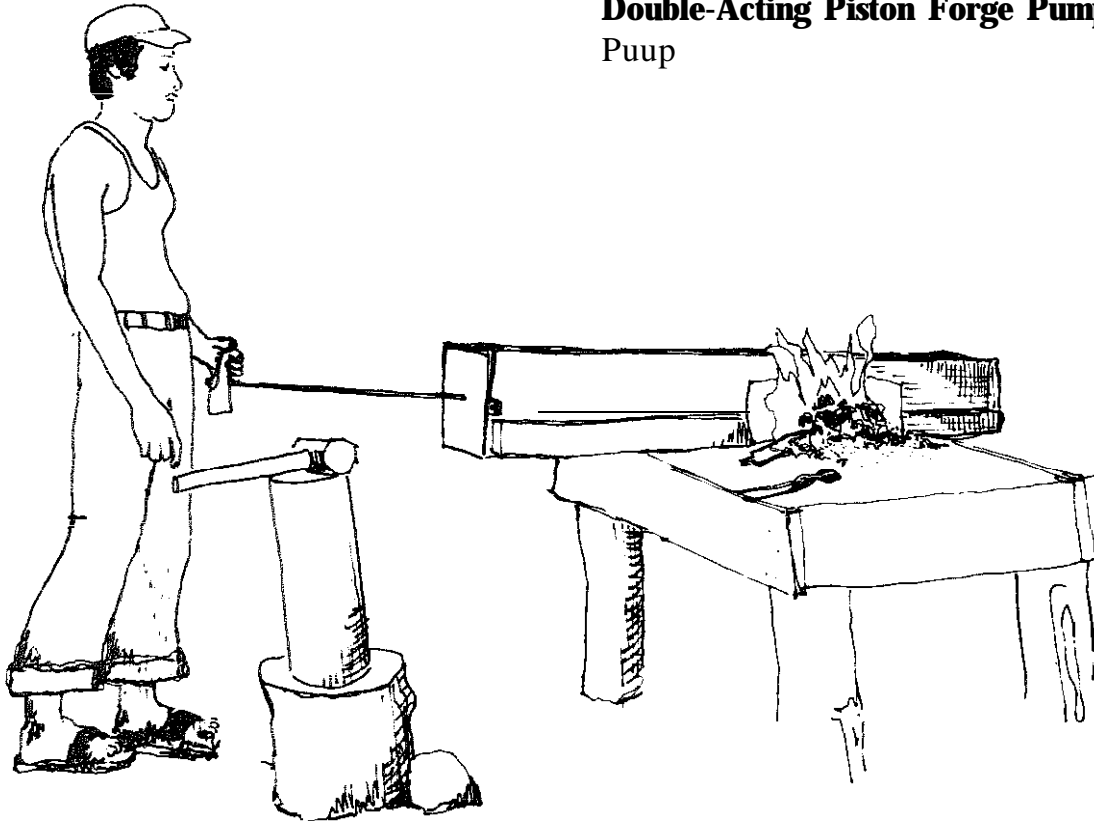

Puup is the **Acehnese** name for a **double-action** piston pump, probably of **Chinese** origin, used by many of the blacksmiths in that province. The *puup* is easy to use and efficient, pumping large volumes of air on both the pull and push strokes of the piston. The *puup* consists of 5 parts:

1. The piston is a square section of board, measuring about 25 by 25 by 3 cm. Several layers of cement sack **paper** are fastened to the four edges of both sides of the board, clamped

in place with strips of iron and bolts. The paper is folded 90 degrees so that it stands perpendicular to the plane of the piston board. The purpose of this paper is to act as piston rings, allowing no air past the edges of the piston. A 2¼ meter plunger rod bolts to the center of the piston, passes through a hole in the center of the board covering the end of the pump body, and has a handle made of buffalo horn bolted to the other end.

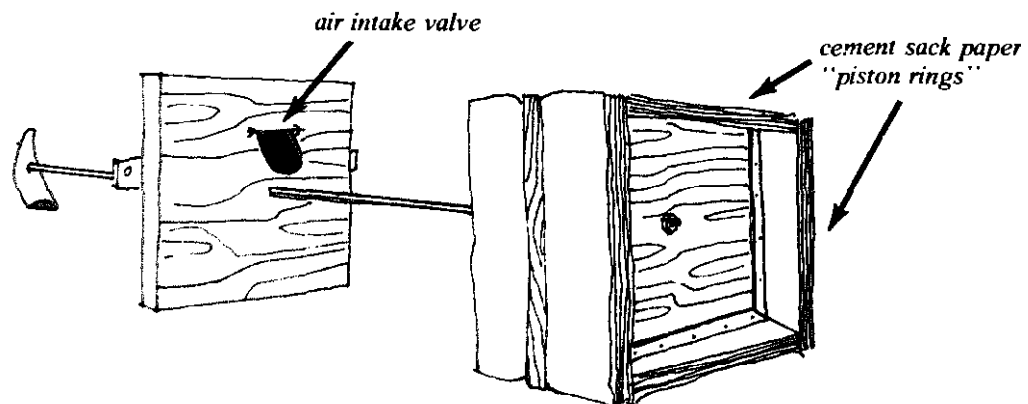

2. The pump body, or "cylinder", is a long rectangular wooden box built of stout hoards. This box is about 2 meters long, with inside dimensions that are slightly larger than the piston, allowing it to slide freely along the length of the box. The square boards bolted onto the ends of the box each have a 3 cm air intake hole. These holes are covered on the

inside by a tin flap hanging on a simple wire hinge, which acts as a one-way valve, opening to allow air in and closing when the piston direction changes and air is forced back. Pumped air leaves the pump body through two 3 cm holes located near the bottom edge of one of the boards, one at each end.

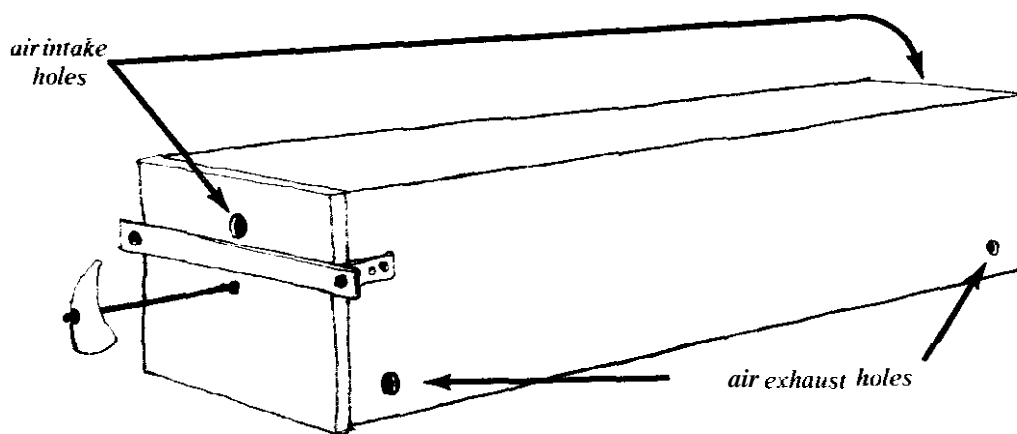

3. An air channel is chiselled into a long piece of wood, giving it a cross-section like the letter "c". This piece of wood is nailed onto the side of the box, each end of the channel covering one

of the exhaust air holes mentioned above. Cut into the midpoint of this piece of wood is the triangular housing of a two-way valve.

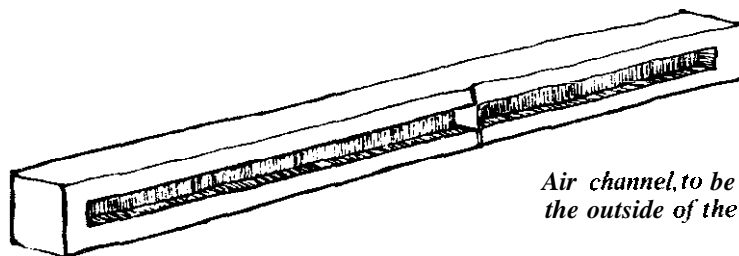

Air channel, to be attached to the outside of the cylinder box.

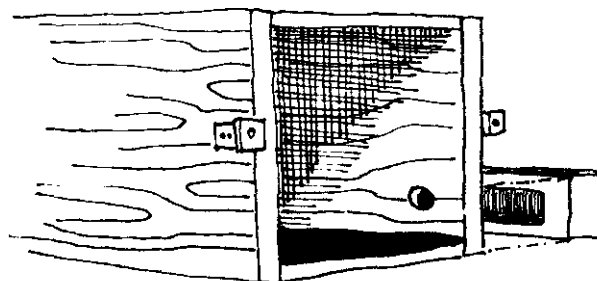

Placement of air channel on outside of box.

4. The two-way valve consists of a tin flap on a wire hinge which swings back and forth across the triangular channel cut in the center of the air channel housing. The wire hinge fits in notches cut into the air channel housing. Air rushing through the channel from one end of the pump forces the valve flap across the chamber, closing the channel leading to the half of the pump drawing in air.

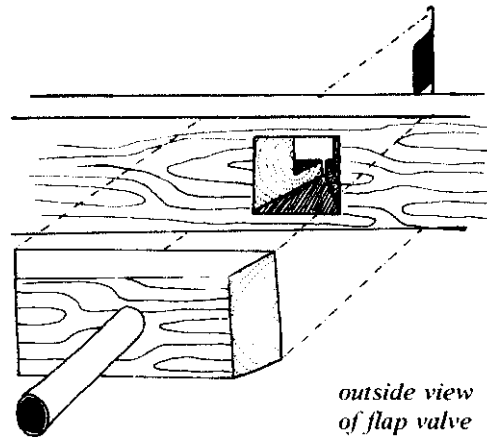

*outside view
of flap valve*

5. A 3 cm diameter iron pipe fits snugly into a hole in a wooden block which covers the two-way valve opening. This pipe transports the air

from the valve to the tire. A clay or sheet iron shield protects the wooden pump from heat and sparks from the fire.

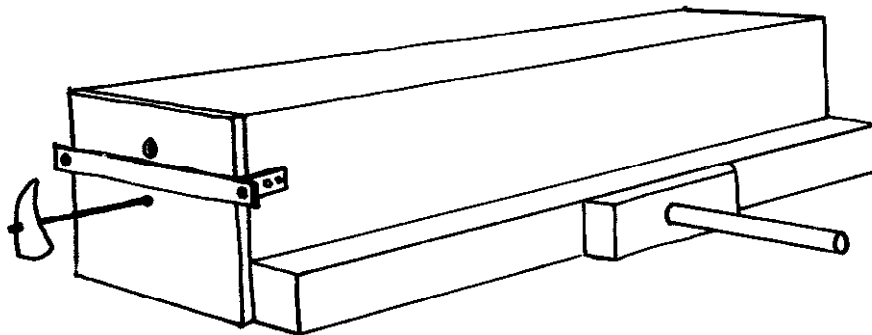

How the *puup* works:

At the start of the first stroke the piston plunger (located on the left side in the drawings on the next page) is all the way in, and the piston is at the right end of the pump chamber. As the piston is drawn to the left by pulling on the plunger rod handle, air is sucked into the pump chamber through the one-way valve on the right end. At this time the one-way valve on the **left** end of the housing is held closed by the pressure of the air being pushed by the piston. The air on the left side of the piston leaves the pump chamber through the hole leading into the **left** end of the air channel, and rushes

through that channel into the two-way valve housing. The flap of the two way valve is forced over to the right side of the valve chamber, closing the end of the air channel connected to the right side of the pump, and directing the pumped air **through** the iron pipe into the tire.

When the piston has been drawn all the way to the left end of the pump chamber, the stroke is reversed. Pushing the piston plunger to the left causes air to be drawn into the pump chamber through the one-way valve on the left end of the pump body. The one-way valve at the right end of the pump closes. Pumped air

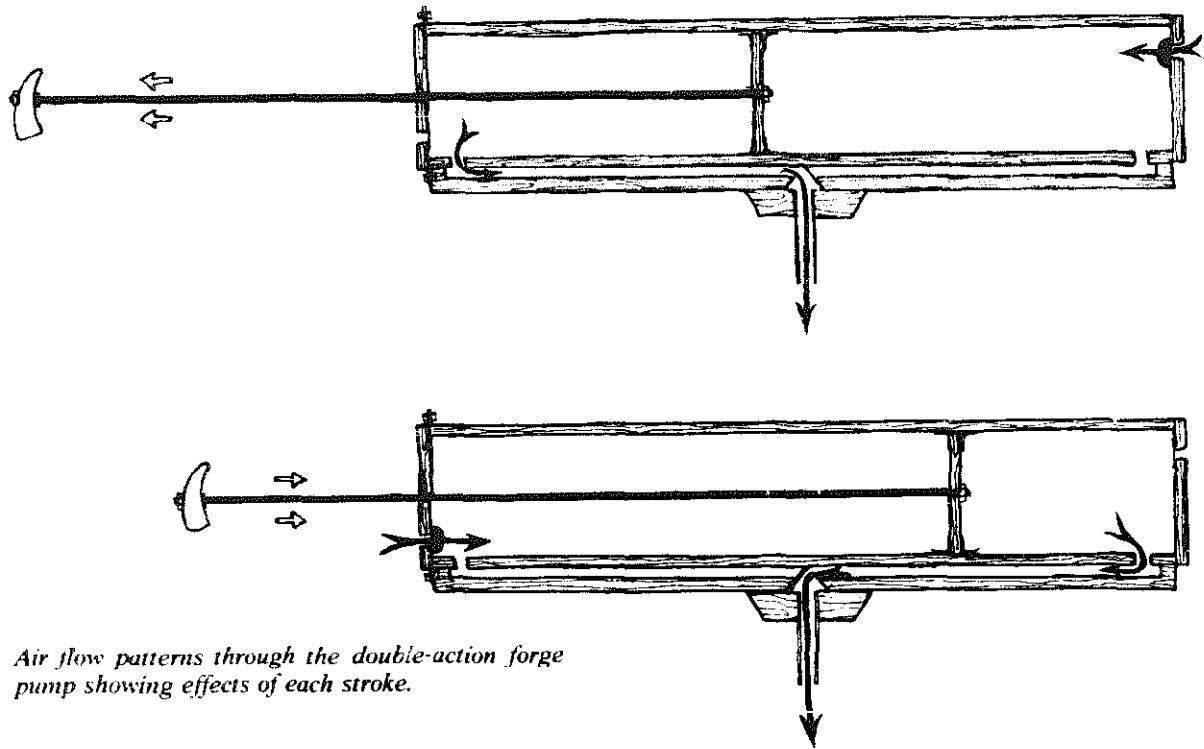

Air flow patterns through the double-action forge pump showing effects of each stroke.

entering the air channel from the right end of the pump forces the flap of the two-way valve to swing across the valve chamber, closing the channel from the left end of the pump and directing the pumped air through the iron pipe into the fire.

The *puup* works well; a slow rhythmic back and forth motion of the piston, requiring only light pulling and pushing, produces a strong draft of air. The smith can work the *puup* himself, while most other types of forge pumps require two men — one to pump, and one to handle the iron.

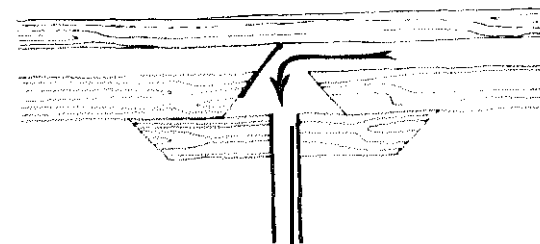
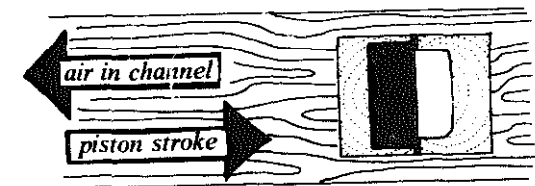
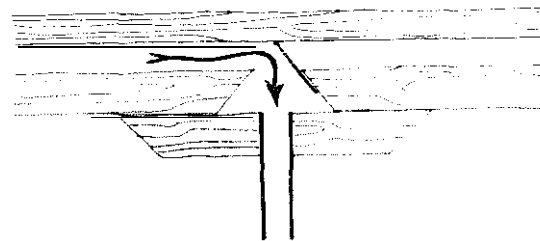
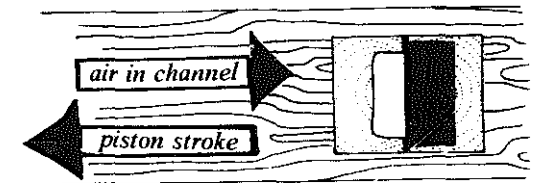

Other Air Pumps/ Ububan dan Puup Lain

While most **Acehnese** and other Sumatra" blacksmiths use the box bellows **type puup** just described, a few prefer to use more traditional goat skin bellows, which they also call **puup**. This type of **puup** consists of a pair of **goatskin** bags, each made from a whole goatskin. The front **leg** holes are sewn shut and sealed with pitch, and the neck hole is lashed onto a short **wooden** cylinder, with a section of iron pipe running through it. The back end of the skin is cut off just in front of the legs, forming a large opening. Two handles are cut in the skin, and two bamboo strips are tied on, so that the opening can be pinched shut.

This type of **puup** requires two **people**—one to pump and the other to tend the iron in the fire. Pumping requires a certain degree of manual dexterity. **alternately** opening one bag and pulling it back so that it **fills** with air, while pinching the other shut and pushing it flat, forcing out the air.

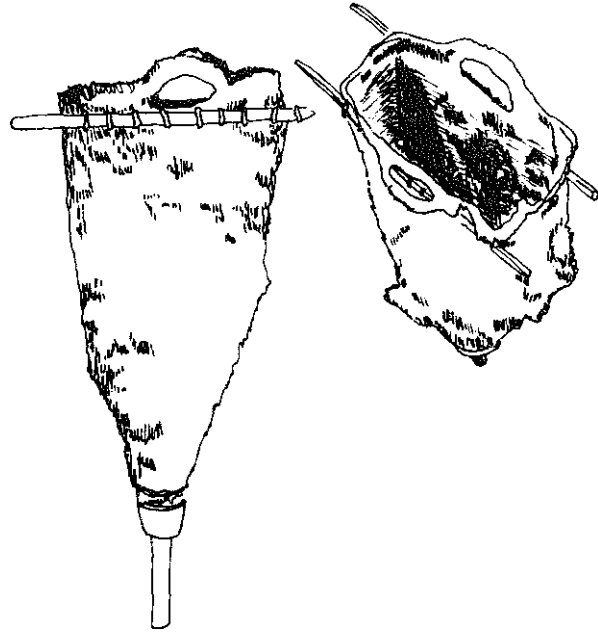

The traditional two-tube **Javanese *ububan*** is being replaced by box bellows and rotary fan type *ububan*, but some blacksmiths still prefer this model. The twin cylinders are made either from hollowed out palm tree trunks or from sheet metal. Each tube has an outlet pipe at the base, which join in a "Y" so that there is a single outlet into the fire. The pistons are long wooden rods with round wooden disks at the bottom which fit inside the tubes. Chicken feathers are fastened around the edge of each disk in an overlapping pattern. The pumper sits on a high bench and alternately lifts and pushes down the plungers. This *ububan* also requires two people.

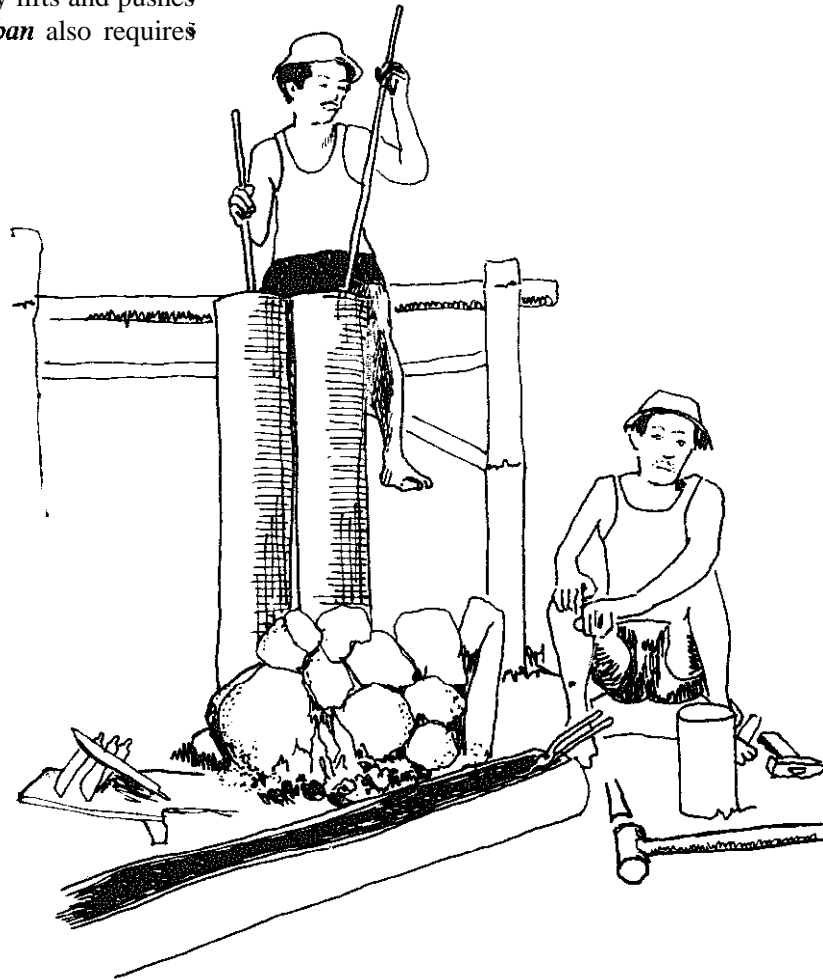

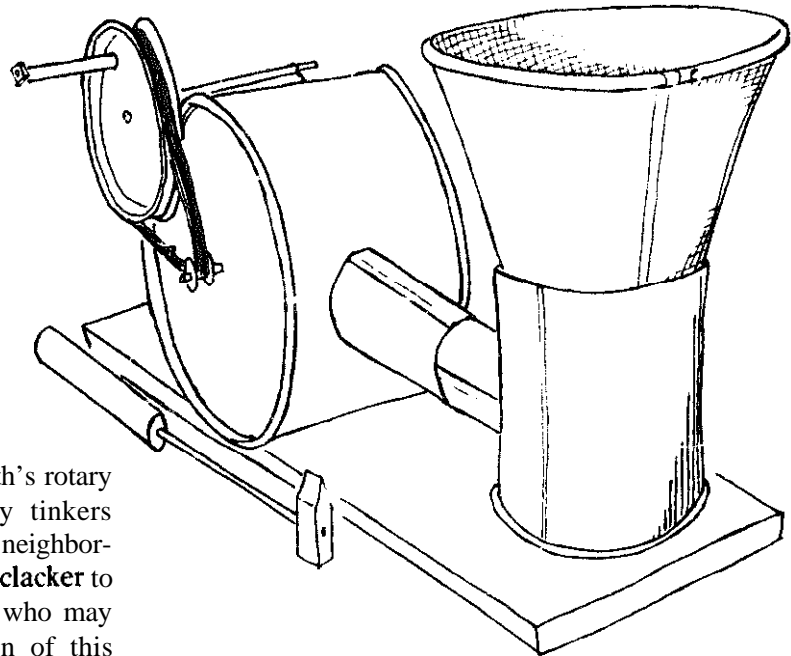
Tier's **Forge/Ububan Patri**

A device similar to the blacksmith's rotary fan, but much smaller, is used by tinkers (*tukang patri*) who wander through neighborhoods rattling their distinctive metal **clacker** to **announce** their presence to anybody who may need soldering done. The operation of this *ububan* is identical to the larger ones, but a few of its components differ considerably.

Instead of flat radial blades, the fan has Z-shaped petal blades. A paint can lid, pierced through the center, has four radial cuts reaching almost to its center. The edges at each cut are folded about 45 degrees, one to the left and one to the **right, giving** each blade a Z-like profile. **When the fan turns**, the leading edge of each blade pulls air into the fan chamber and then forces it through the connecting tube into the charcoal brazier. **Air enters the fan chamber** through a hole in one **side**. A small pulley with a crank is used to **turn** the fan, by means of a belt made from **innertub** rubber.

The bottom of the brazier, where the air enters, is **hollow**. A perforated base holds the charcoal up in the cone-shaped top section. It is big enough to hold a handful of charcoal, enough to heat the copper headed irons used for soldering. The irons **are** also produced by local craftsmen.

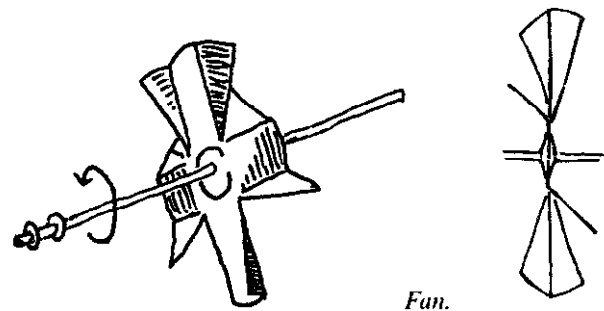

Fan.

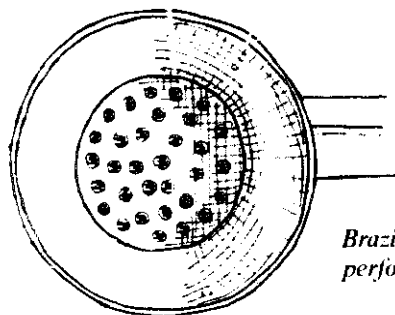

Brazier with perforated base.

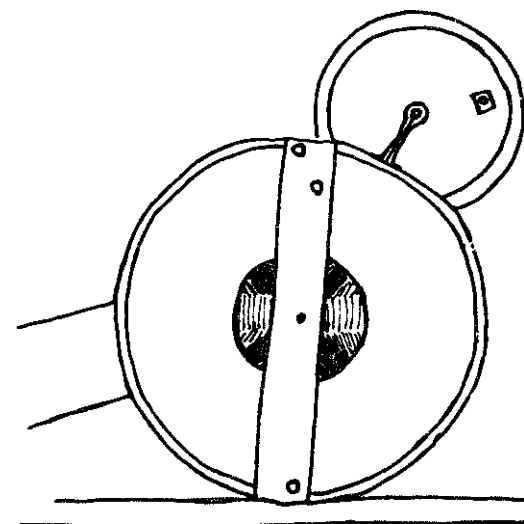

Right side view showing air intake.

Silver **Soldering**/Patri Perak

Indonesian **silversmiths**, especially those of Central Java, **Bali**, West Sumatra and Southeast **Sulawesi**, achieve very intricate results using **rather** primitive technology. The Technique for soldering, one of the most delicate operations in jewelry production, presents a striking example. For soldering **silver**, the craftsman needs 3 tools:

1. A kerosene lamp made of a can with a spout **similar** to those on watering cans, stuffed with a piece of rag to act as a wick, provides the **flame** for soldering.

2. A thin **metal** tube, shaped **like** the letter L is used to blow the flame. The mouth end is almost 1 cm in diameter, tapering down to a 2 or 3 mm nozzle at the **bottom**.

3. A piece of pumice or other porous volcanic rock, ground flat on one side, is used to hold the piece being soldered.

With these simple tools, talented silver-smiths can solder tiny delicate **filagree** pieces **without** melting them into blobs of metal. **The process is very simple.**

1. **The** shaped and assembled piece is placed carefully on the stone.

2. The piece is **sprinkled** with a fine layer of silver **filings collected** from the bench where the craftsman files and scrapes the unfinished pieces.

3. **The** stone is betd in the left hand about 10 cm from the base of the flame.

4. With the tube, the **craftsman blows** the flame onto **the** piece. As the silver **begins** to **turn** a dull red color, the dust melts and binds the pieces together. The craftsman carefully **moves** the stone and piece under **the** flame until **all** sections are bound, **moving** each portion out of **the flame** as quickly as the dust melts; if he delays **the** piece **will** begin to disintegrate.

After soldering, the metal is black, and must be cleaned with a mild acid solution. **The** piece is then ready for finishing, the application of clasps, stones, and so forth.



Blowing flame onto silver piece.

Spinning Wheel/Pemintal

Pemintal, or spinning wheels, have improved very much in Indonesia during the last half century. Although the design and operation are unchanged from the old models now found in museums and antique shops, the use of bicycle parts in their construction makes the newer *pemintal* easier to produce, longer lasting, steadier and easier to use. *Pemintal* have 3 parts:

1. The crank wheel is made from a bicycle rim. The spokes and hub are usually replaced by a wooden cross, one of which is given a crank handle.
2. A string looped around the crank wheel turns the axle of a bicycle front wheel hub. The hub is held stationary in a block of wood that is part of the frame. A wire hood or wooden bobbin is attached to one end of the axle.
3. A wooden frame holds the two moving parts.

The illustration below is of a *pemintal* used to wind silver wire for filagree jewelry production. A long single strand of silver wire is doubled. The looped end fits across the hook on the *pemintal* axle and the opposite ends are attached to a heavy wooden block set across the room. The wire is then spun to the desired tightness. During this process, the block must be moved toward the operator a few times, to prevent the wound wire from becoming too taut.

For spinning yarn, a long, thin, cone-shaped bobbin is attached to the axle on the side pointing toward the operator. The fiber is wrapped around this bobbin to be pulled off in a single strand as the wheel is spun.

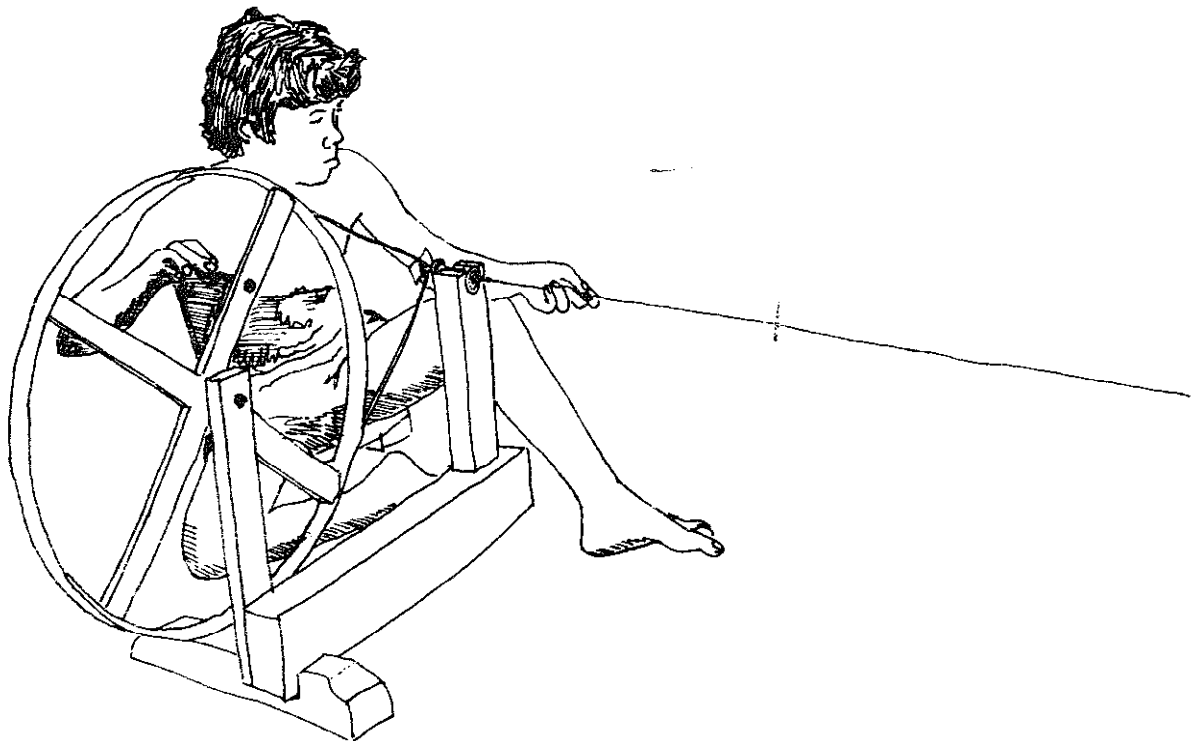

Two-Man Grinder/Pengasah Pisau

Grinding and sharpening knives, axes and other implements is the blacksmith's most tiring and time-consuming job. Acehnese blacksmiths use human-powered circular grindstones to complete this task quickly and easily. The Acehnese rotary grinder consists of four parts:

1. A carborundum grinding wheel. Previously, discs of local basalt were used.
2. A grinder shaft, made of lathed hardwood. The shaft is about 35 cm long with a diameter of 4 to 5 cm. The stone disc is cemented to this shaft near one of the ends, using a glue made from dissolved termite dwellings. Cone-shaped iron points are fitted into both ends of the shaft to serve as bearings.
3. A 2 meter cord with wooden pegs for handles tied at both ends, which is wrapped three or four times around the grinder shaft.
4. A stand which also serves as the operator's

bench. The weight of the operator keeps in place the two vertical boards which hold the ends of the grinder shaft while it is turned by the operator's assistant.

The grinder is assembled in a few seconds and the operator sits on the bench, leaning over the grinding wheel. His assistant sits in front of him, facing towards him. The assistant pulls one end of the rope until the opposite end is near the spinning shaft. Then he pulls back the other end, causing the shaft and stone to turn in the opposite direction. The operator holds the blade firmly against the spinning stone, sharpening it in much less time than is required using a flat whetstone.

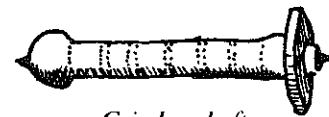

Grinder shaft and wheel.

Sharpening a knife.

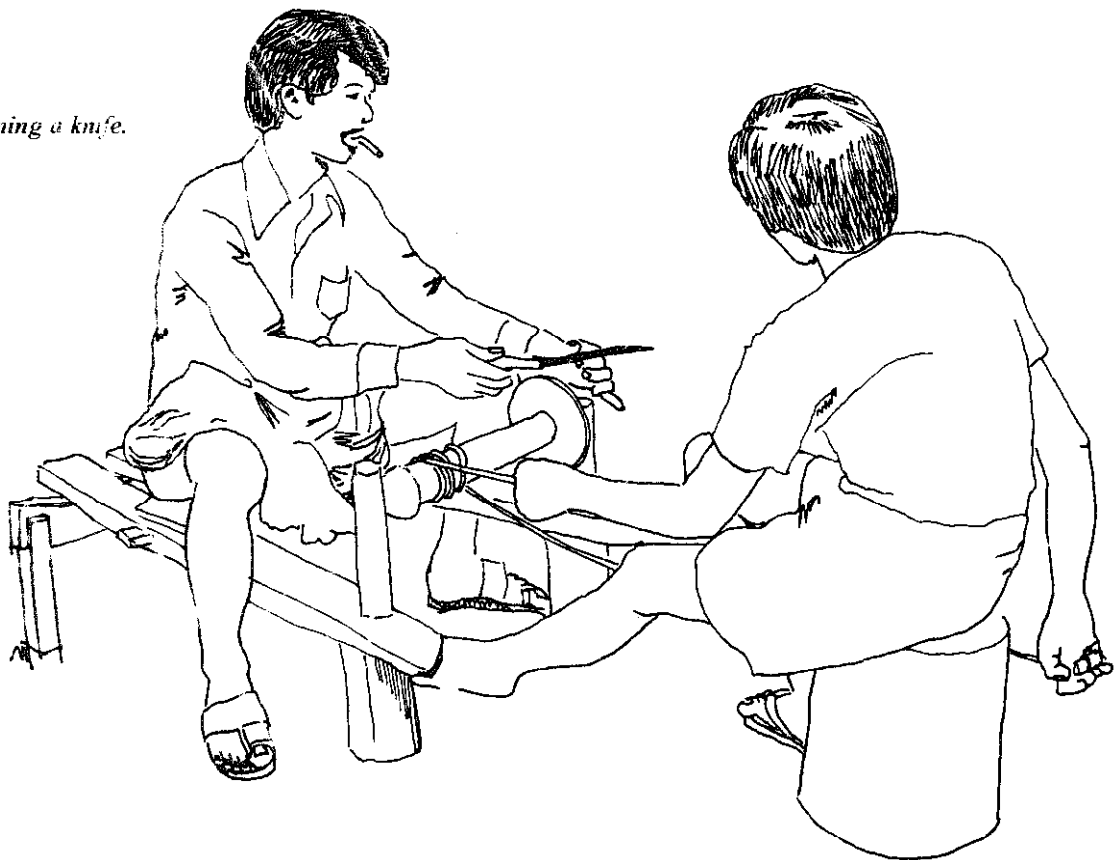

Grinding **Wheel**/ Penggosok Batu Cincin

West Sumatra is the source of many colorful semi-precious stones. Large rings bearing these stones are very popular in Indonesia. The stones are shaped and polished with grindstones, sandpaper and bamboo. A common type of *penggosok* grinder/sander is hand-cranked, using bicycle components to increase the speed of rotation to a usable level. A bicycle pedal and **chainwheel** assembly is hand cranked, driving a chain which sets a bicycle rear wheel spinning at a higher speed. This wheel drives a belt which turns a small wooden pulley bolted onto a bicycle axle. The hub that surrounds the axle is clamped to the workbench.

A commercially-made **carborundum** stone is bolted to one end of the axle, and a small wooden wheel to the other. The **carborundum** stone is used for roughing out the shape of the stone. Fine emery cloth is fastened to the **wooden** wheel with a rubber band. **This** is used to smooth the stone after the proper shape has been attained. The stone is then hand sanded and finally polished by **rubbing** it parallel to the grain of a section of bamboo from which the **outer** skin has been removed. Bamboo has a high silica content, which makes it a fine abrasive.

The finished stones are set in large brass or silver rings, which are sold throughout Indonesia.

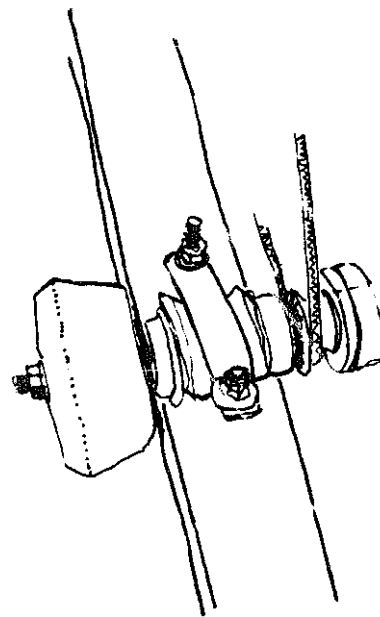
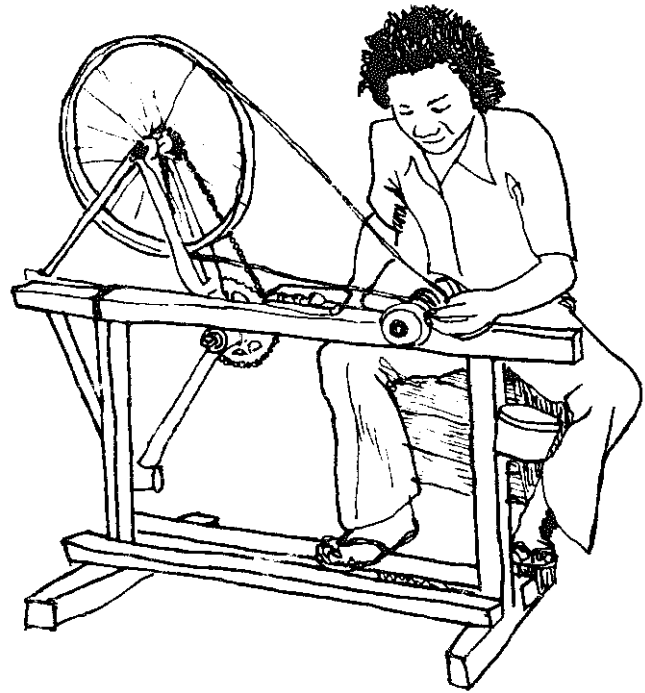

*Carborundum stone
and wooden wheel
with emery cloth.*

Pump Drill/Bor

The pump drill is one of the most ancient mechanical tools known to man. For certain applications, it is still preferred by some craftsmen. It performs quickly and accurately without an inordinate amount of care or effort by its user.

The pump drill consists of four or five components:

1. A round drill shaft about 30 or 40 cm long with a diameter of 3 or 4 cm.
2. A **flywheel**, usually a section of heavy hardwood connected to the base of the drill shaft like a **propellor**, or a stone-filed coconut shell.
3. A drilling bit, usually a metal spike with the end flattened to a point and two sharp edges, forced into the lower end of the drill shaft.
4. A pumping handle, a straight piece of wood about 30 cm long, with a 60 to 80 cm piece of rope tied to both ends. This rope fits into a notch at the top of the drill shaft, or passes through a hole near the top.
5. **Sometimes** a wooden palm piece, notched to serve as a bearing, is held over the top of the drill shaft with one hand to guide the drill while it is pumped with the other hand.

With the pump drill, alternating rotary motion of the drill is produced by up and down motion of the pumping handle. The cord is wrapped around the shaft. A downward motion of the handle causes the shaft and bit to spin as the cord unwinds. Spinning momentum, assisted by the weight of the flywheel, then winds the cord in the opposite direction around the shaft. The handle is pushed down again, causing the drill to spin in the opposite direction. A rapid rhythmic pumping motion keeps the drill spinning quickly back and forth.



Drilling a buffalo horn knife handle.

Wood **Lathe**/Bubutan Kayu

Two different treadle-driven wood turning lathes, *bubutan kayu*, were designed and produced by a Central **Javanese** villager whose small cottage **industry produces** toys which are sold locally. Both lathes have very simple and functional designs. The smaller lathe is long enough to **accomodate** pieces up to about 80 cm in length, but has a very light flywheel and is usually used only for small toy parts. The larger lathe takes pieces up to about **150** cm, and its flywheel is heavy enough to **accomodate** such work.

Both lathes feature a reciprocating pedal linked to an offset cam on the flywheel axle, so that one up and down stroke of the pedal

corresponds to one revolution of the flywheel. Belts and pulleys increase the speed at which the stock turns. A **pedalling** rate of about 100 strokes per minute produces a good working speed.

The flywheel of the smaller lathe is made from a bicycle wheel rim. The spokes are **replaced** with a wooden cross, bolted at the center to the iron rod axle. 4 teak blocks are fastened to the spokes **to give** the flywheel extra weight. The axle is mounted in wooden beams using ball bearings which are press-fitted into holes in the wood.

A bicycle crank arm, with the pedal end **sawn** off, is bent in the middle so that it forms a 90 degree angle. This forms the reciprocating cam, with a 10 cm stroke, and clamps onto the end of the axle.

The linkage between the cam and the pedal is a cast iron part with ball bearings in both ends, purchased from a junk dealer. It probably comes from a treadle-driven sewing machine.

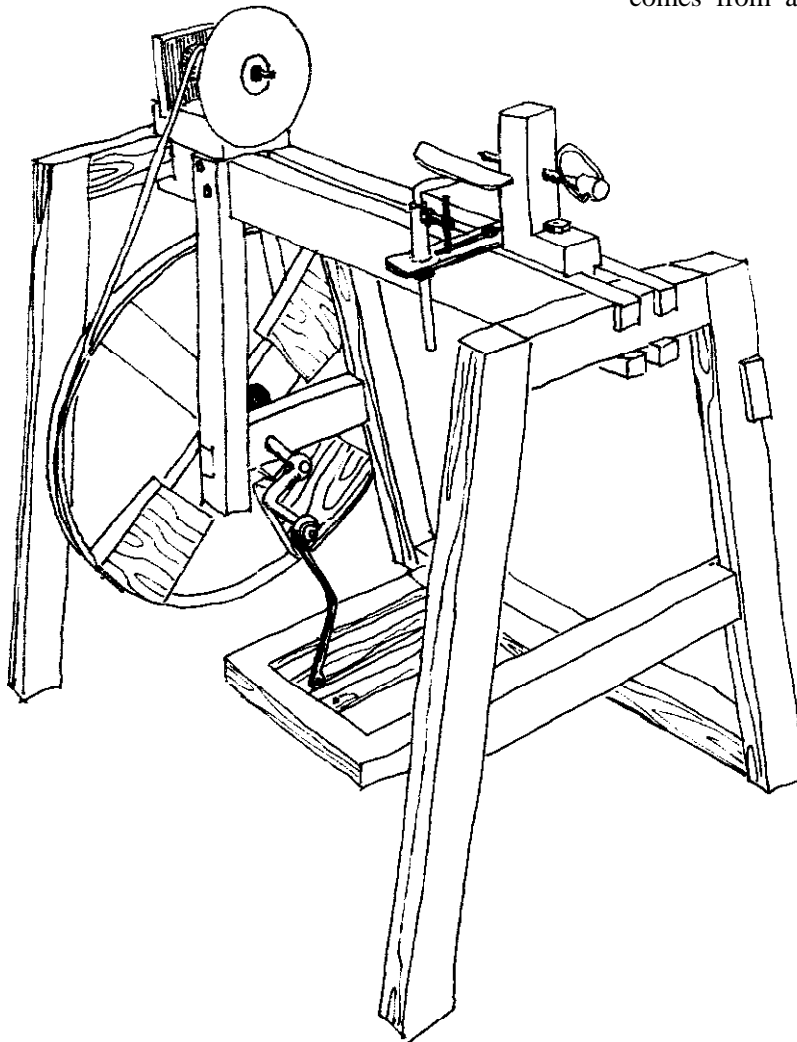

Small lothe.

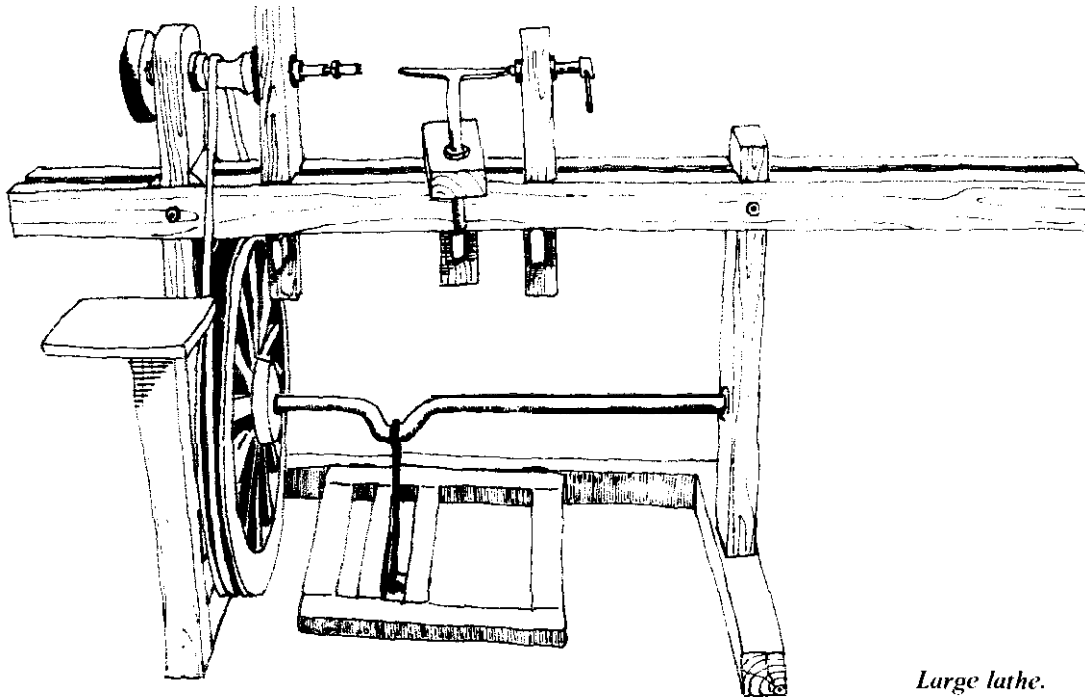

Large lathe.

The treadle and flywheel assembly of the larger lathe is quite different than that of the smaller model. The flywheel is made from a wooden front wheel from an **andong** carriage, with its **iron** rim removed and a groove cut in the edge **to accomodate** the drive belt. The wheel is attached to a **heavy** iron axle which is mounted in the legs of the lathe with ball bearings. This axle has a U-shaped bend which acts as the reciprocating cam. The bend **is about** 8 cm deep by **10** cm wide. The iron linkage between the axle and the treadle does not use ball bearings

on this lathe. The cast rod with loops at both ends was purchased from a junk dealer. The bottom end of **this** rod connects to a short bar between wooden members of the treadle. The **treadle** is a rectangular wooden frame. **Unfortunately**, the treadle is not wide enough to reach while working on the tailstock end of long pieces. This limits the length of pieces which can be turned on this lathe to about 1 meter, unless two people operate the lathe, one pumping the treadle while the other works the wood.

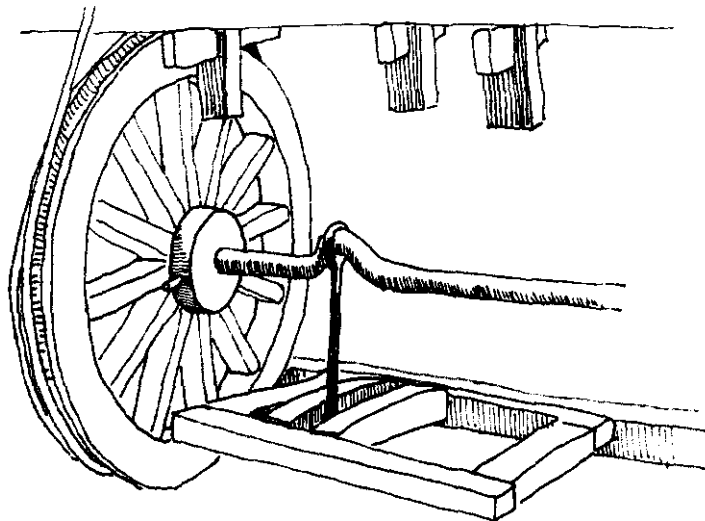

Treadle and flywheel assembly of large lathe.

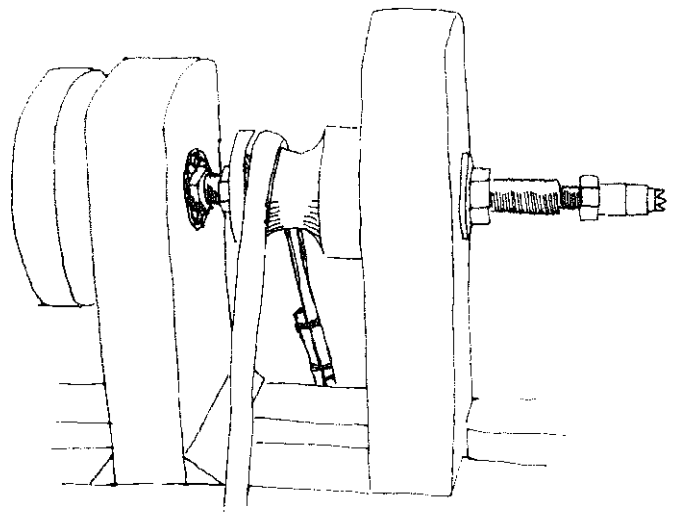
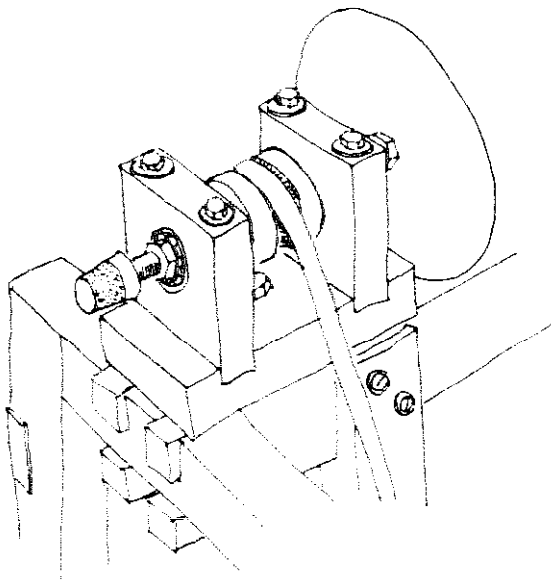

The headstocks of both lathes are very similar. Power is transferred to the headstock by a belt made from tire rubber. There is a wooden pulley fastened to the headstock shaft. The pulley sits between two wooden uprights with ball bearings for the shaft. The shaft is threaded so that nuts can be used to keep it in place. The bit is made from a short piece of steel rod with a larger diameter than the shaft. It is welded onto a nut and mounted on the end of the shaft. Three teeth (for gripping the wood) are cut into the end of the bit with a hacksaw, then tempered by heating until red and quenching with water.

Grinding wheels for sharpening tools, homemade sanding discs (made by gluing sandpaper onto wood discs or small round or cone-shaped plugs) and other attachments are bolted onto the shaft.

The tailstock and adjustable tool-rest of each lathe are very similar, differing only in the manner in which they are attached to the lathe. Both lathes have twin beams with a space between them. The tailstock and the tool-rest are mounted in this space and can be slid into the proper position and secured there. The smaller lathe uses bolts to hold these parts in place. The older, large lathe uses wedges driven through the bottom of the thin section of the wooden tailstock and tool rest mounts between the twin beams.

The tailstock has a fixed shaft with a sharp point that pierces the end of the wood being turned. Once the tailstock is correctly posi-

tioned, the shaft is turned until it pierces the end of the wood to be worked.

The adjustable tool-rest is fabricated from welded metal and can be adjusted both vertically and horizontally. Vertical adjustment involves loosening a bolt on the vertical tube which holds the tool-rest; horizontal adjustment requires loosening the mounting bolts and sliding the whole assembly.

Both of these lathes work quite well. The operator can either stand in front of them or sit on a tall stool, the latter making it slightly easier to pump the treadle at a rapid rate. The lathes are about 90 cm high, a comfortable working height for Indonesians. The only maintenance required is occasional tightening or replacement of the belt, and the addition of a drop of oil on the ball bearings. The two lathes shown here have already been in use for several years.

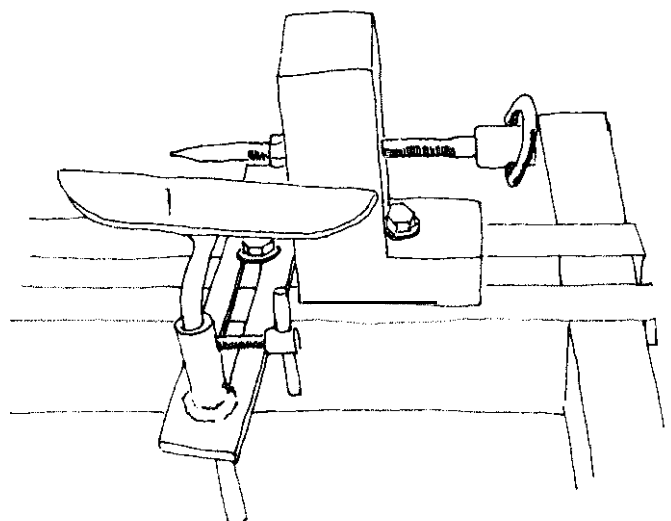

Potter's **Wheel**/Putaran Gerabah

Wheel-turned pottery has several advantages over pots formed with the pinch or coil methods. It is stronger, breaks less during drying and firing, is more attractive, can be made thinner, and can be produced many times as fast.

A simple porters' wheel, or *putaron gerabah* is used in many pottery villages in **Sunda** and Java. It consists of 3 parts:

1. A large stone wheel, chiselled from basalt or sandstone. The wheel has a diameter of 25 to 40 cm and is about 5 or 6 cm thick. A flange is cut on the bottom, with a hole 2.5 cm in depth and 8 cm in diameter in the center, corresponding to the dimensions of the bearing.

2. The wheel turns on a steel ball bearing that fits into the flange under the wheel. A piece of cloth covers the bearing to assure a snug fit. The bearing has an inside diameter of about 4 cm and an outside diameter of about 8 cm.

3. The wheel and bearing assembly is placed vertically upon a wooden stake, with the top carved to fit tightly into the bearing hole. This stake is either driven into the ground, or fits into a heavy stone block.

After the wheel is assembled, a ball of clay is slapped onto its center and the wheel is given a few strong counter-clockwise turns with the left hand. The clay mound is patted until symmetrical, then is wetted to be formed by both hands as the wheel spins. Every few seconds the wheel must be given another strong turn with the left hand to keep it spinning fast enough.

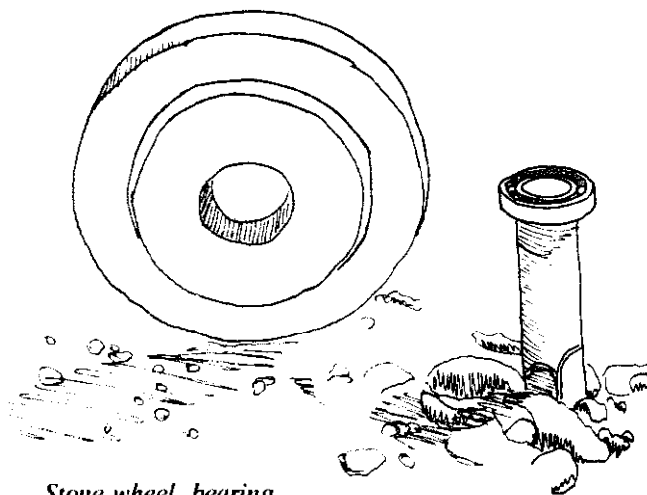

Stone wheel, bearing and wooden stake.

Melded Clay Forms/ Pengecoran Tanah Liat

A simple molding technique is used to manufacture certain ceramic forms. usually decorative animal sculptures for sale as curios and souvenirs.

Convex sections, halves or quarters of the finished form. are made individually. **The** mold is dusted with fine ash so that the clay does not stick, **then hunks** of soft clay **are** pressed into the **mould** and smoothed until even, about 1 to 1½ cm thick. depending on the size of the finished piece. **The** mold is then set aside for the piece to harden while another piece is made in a new mold.

After the pieces are removed from the mold. they are set aside until they become stiff enough for assembly. **Then** the edges are trimmed and roughed, a watery clay slip is applied and they are pressed together. Once the joints have hardened somewhat, they are smoothed and decorative trim is applied to the outside of the piece. On well designed castings the trim can be applied over the joints between the molded parts, thereby increasing their strength.

After drying, the pieces are **fired** at low temperatures, either in open fires or simple updraft kilns. They are sold either glazed, **unglazed** or painted. Lead oxide is the most

common glaze, producing a shiny brown finish. In this use it is not harmful as the sculptures **are** not used to hold food or drink. However, the artisans should use greater care in preparing and handling the lead glaze.

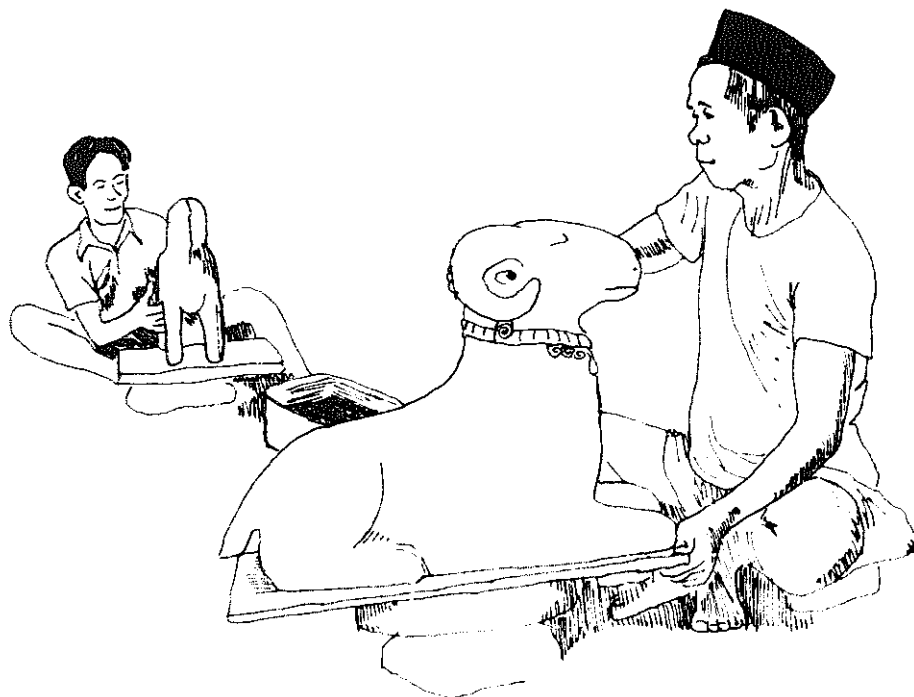

Tire Patching/Vulkanisasi

As motorized transport becomes more popular in Indonesia, punctured tires become more common. Travellers in isolated areas are well advised to carry standard tire patch kits consisting of solvent cement and special patches. But along the country's well travelled roads there are many small tire patching businesses. They make very strong patches, using heat to join the patch onto the inner tube in a process called *vulkanisasi*. A tire patching business requires the following tools:

1. A press for applying heat and pressure to the section of inner tube receiving the patch. The press has a large bolt passing through a threaded hole or nut in the iron frame above a platform. The top is given a handle for easy turning. Heat is provided by a small kerosene flame. Many presses use a small wick stove below the press platform, but a better type beats the patch from above, with the fire in a receptacle such as a bicycle bell or automobile piston held in place by the press bolt. This method is superior because it applies heat only to the patched area, saving fuel and avoiding damaging other parts of the tube.

2. Cement for applying the patches can be purchased from auto parts stores, but many tire

patchers prefer to make their own by mixing rubber filings with gasoline to form a viscous paste.

3. A file is needed to rough up the tube around the hole so that the patch adheres well. Bastard files work well; many tire patchers make their own by perforating a piece of tin with small nail holes.

4. A large tub of water is used to search for leaks in the tube.

5. Wrenches and tire irons are necessary to remove the wheel and tire. Pliers are used to remove nails from the tire. There is a special tool for removing the valves.

6. A pump, either a motorized compressor or a hand pump, is used to pump up the tires.

The process for patching tires is as follows:

1. The tube is removed from inside the tire. One bead of the tire is pried until it is outside the rim, and the tube can be pulled out. On motorcycles, this is often done without even removing the wheel.

2. The worker feels around the inside of the tire for nails or other sharp objects which punctured the tube and removes them with pliers.

3. He inflates the tube and submerges it in water to find the leak or leaks.

4. With a file, he roughs up an area around the hole. It should be at least 2 cm wide all the

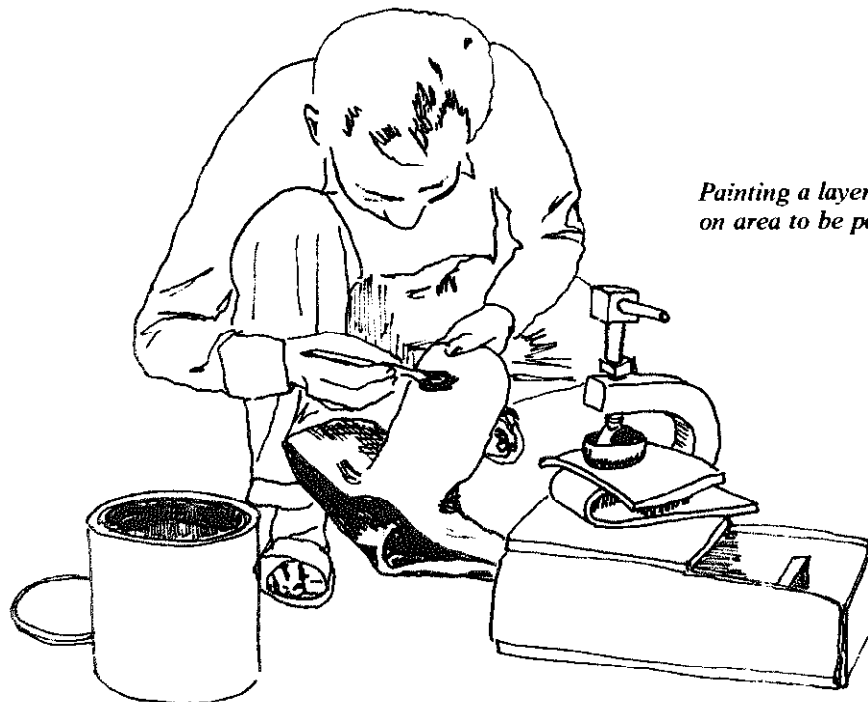

Painting a layer of cement on area to be patched.

way around the hole. Long slashes are sewn **shut** with strong cotton thread.

5. From a **discarded** inner tube, he cuts a patch large enough to cover the filed area.

6. He paints a thin layer of cement on the area to be covered with the patch.

7. He **sets a rectangular** section of tire rubber on the press platform to protect the tube and lays the tube on it so that the hole is directly under the end of the bolt. He then presses the patch onto the cemented section and covers this with a layer of plastic or paper to prevent the patch from sticking to the hot press; cigarette wrapper plastic works well for this.

8. Several different sizes of pistons or bells are stocked for different sized patches. The worker selects one that is the same size or a little larger than the patch and places it over the patch. He then tightens the bolt until it is firmly held in **place**.

9. He pours a **small** amount of kerosene into the piston. With experience he knows how much is necessary to fuel a **fire** long enough to make the patch adhere without melting it. With a scrap of paper or wood shaving as a wick, he lights the kerosene and allows it to burn until it is consumed.

10. He **lets the press cool** before removing the tube. The patch should appear as a smooth lump on the **tube**. If the edges of the patch are still visible, it has not been heated long enough.

11. He inflates the tube and checks it again in the water to be sure it does not leak. If there are no more leaks, he puts the **tube** back in the tire and inflates it.

Whereas patches from a tire patch kit will often come loose, especially if the tube was dirty or damp when they were applied, a well done **vulkanisasi** patch bids completely with the **tube**, leaving the patched area as **strong** as the rest of the tube.

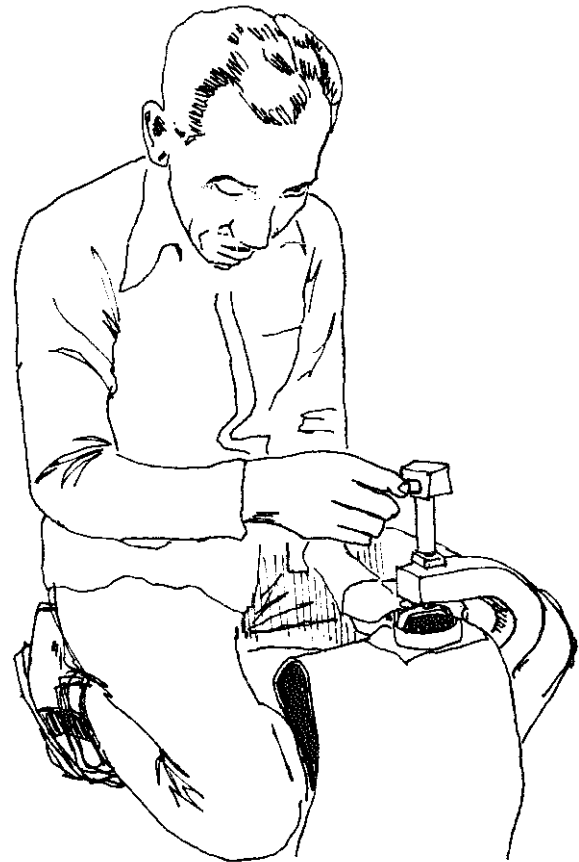

Tightening the press with a patch in place.

Acetylene Gas Generator/ Pembangkit Gas Karbit

Acetylene gas welding is now a very common craft in Indonesia. Thousands of craftsmen ply this trade, reaching small villages and remote provinces. Except in the major cities, bottled acetylene is unavailable. Welders make their own in locally produced carbide generators. These gas generators are very simple to construct and operate. They consist of:

1. An open-top drum, often a used oil or asphalt drum. Three legs are welded onto the base of the drum to keep it off the ground and prevent rust.

2. A cylindrical generating chamber made of 4 or 5-inch iron pipe is welded into the drum near the base. The inside end of this chamber is closed with a welded cover. The outside end has a hinged door which is sealed with inner tube rubber gaskets and a latch made of a large bolt with a T-shaped handle for tightening. A 1/2 inch outlet pipe runs from the top of this chamber up the center of the drum, ending level with the top of the drum. A 1/2 inch inlet pipe draws water from the drum in through the top of the chamber. A gate valve is used to control the water flow.

3. A semi-cylindrical plate iron drawer that holds the carbide fits into the chamber.

4. A cylindrical gas tank with a smaller diameter than the drum fits inside the top of the drum. This tank is made of welded iron plate. It is open on the bottom. A section of 2 inch pipe protrudes from the center of the top of the gas tank; when the tank is in place this pipe fits over the outlet pipe from the gas generation chamber. It is closed at the top with a welded cover. 2 pieces of 1/2 inch pipe extend horizontally from the top of this pipe, one serving as a brace to hold the cover in place, the second doubling as a brace and an outlet pipe. The outlet pipe goes out and then downward to pass through the top of another chamber, ending just a few centimeters above the base of this chamber. This is the flame trap, made of a section of 2 or 3 inch pipe with welded iron plate ends. Another pipe with a funnel at the top also passes through the top of this chamber and ends at the bottom, parallel to the gas tank

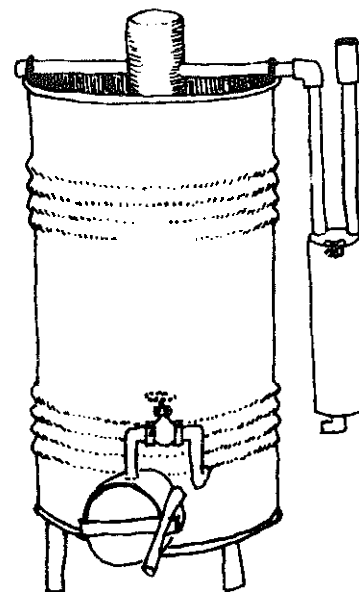

Acetylene gas generator.

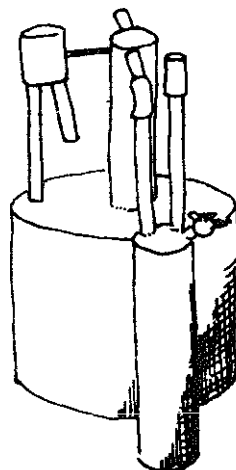

Gas tank.

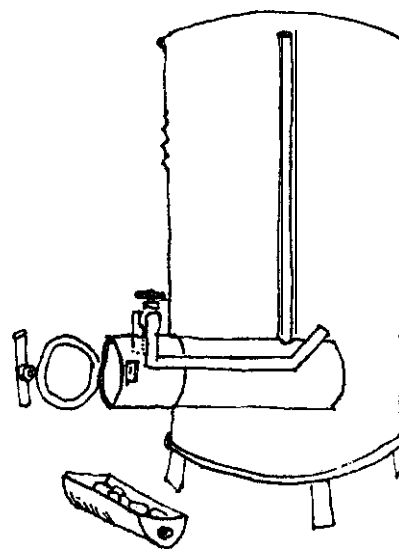

Carbide drawer and chamber.

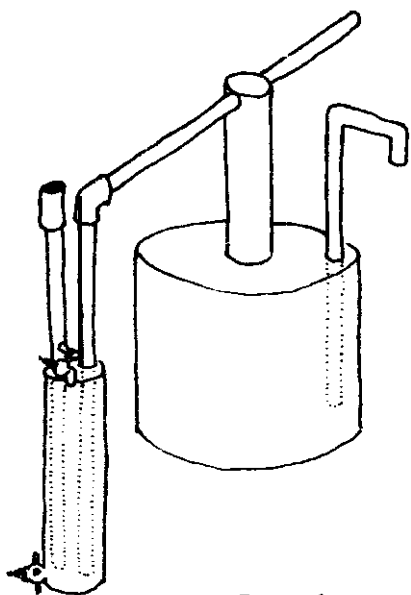

Gas tank.

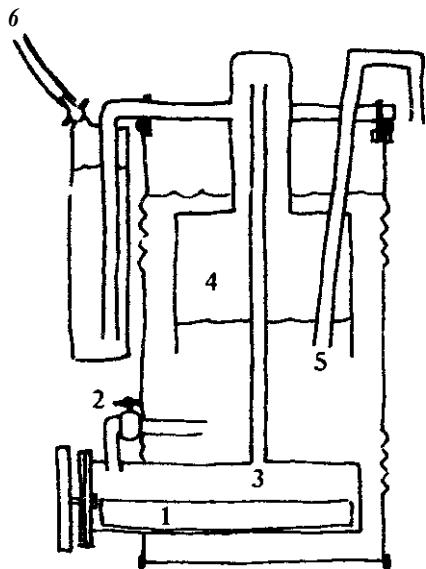

Steps in the production of acetylene gas.

outlet pipe. This is for filling the flame trap with water. The flame trap also has 2 valves, one at the base to empty the water and another at the top to draw off the gas. The gas valve has a nozzle to fit a rubber gas hose. There is one other pipe leading out of the gas tank. Its bottom opening is a few centimeters above the base of the gas tank. This pipe pierces the top of the tank and hooks over the top of the drum when the gas tank is in place. This pipe acts as a gas **overflow** if the **tank** becomes too full of gas.

To generate gas, first the drum is filled about two-thirds full of water. The gas tank is secured in place inside the drum. The flame trap also must be about two-thirds full of water. The generation process is as follows:

1. A few chunks of carbide are placed in the drawer, which is set into the generating chamber. The generating chamber door is tightly closed.

2. The inlet valve is opened a few turns, allowing a small amount of water from the drum to trickle onto the carbide.

3. As the water comes in **contact** with the carbide, it gives off acetylene gas. This gas leaves the generating chamber through the outlet pipe and begins filling the top of the gas tank.

4. The gas is trapped in the tank by the water. As the gas volume increases, water is displaced downward out of the gas tank and rises in the drum outside of the tank.

5. If **the gas** tank becomes too full, excess gas is bled off through the gas overflow pipe.

6. When the gas valve is opened, the pressure of the displaced water in the drum forces the gas through the outlet pipe into the bottom of the flame trap. The gas bubbles up through the water and is then drawn off through the valve into the hose to the welding nozzle.

When gas generation ceases, more water is let into the drawer of carbide in the generating chamber. If no new gas is generated by this process, the carbide is used up and must be replaced. The carbide drawer can be removed, dumped out, then replaced with new chunks of carbide.

Electricity Generating Waterwheel/

Kincir Air Pembangkit Listrik

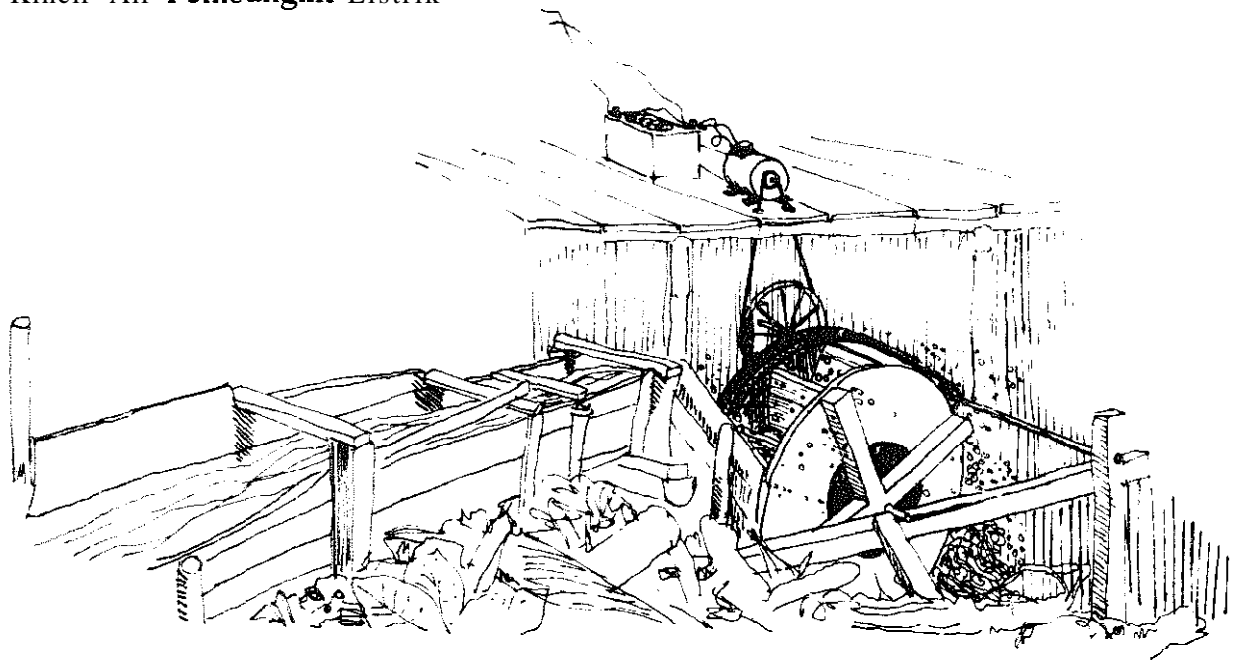

Rural electrification is high on the central government's list of development priorities. However, it will be **many** years before the **electric** grid reaches **some isolated** areas. One **villager in Kabupaten Tasikmalaya**, West Java, decided not to wait.

The man, an illiterate farmer, pondered the water rushing by the front of his yard in a deep irrigation canal. Without ever having seen another waterwheel, he designed and built the **electricity** generating **kincir air** depicted below. Using **belts** and pulleys to speed up the rotation, he uses the power of **falling** water to drive a 12 volt automobile alternator. The owner uses the current to charge both 6 and 12 volt batteries for a fee. His neighbors bring batteries that they use to power radios, cassette players and televisions. Buying an expensive automobile or motorcycle battery and then **recharging** it every few days or weeks for a few **rupiah** is a much less expensive way to power these appliances over the long **run** than buying new dry **cell** batteries frequently. In addition to **his stroom accu** business, the owner of the **kincir** has **run** wires to his house to light two automobile taillight bulbs for **nighttime illumination**.

A weir forces the water into a wooden

channel about 35 cm wide by 35 cm deep. The water rushes down a $\frac{1}{2}$ meter drop before splashing into the wheel. The 1 meter diameter wheel is technically a center-shot wheel, taking on water about half-way up its **uphill** side. Below the wheel the channel continues to drop so that the wheel is actually out of the water, above the surface of **the stream** as it rushes away.

The wooden wheel turns on a bearingless iron pipe axle, revolving about **50** times each minute. A strip of wooden blocks about 10 cm wide built into one side of the wheel flush with the wheel's circumference serves as a seat for the drive belt. The drive belt, a 7 cm wide strip of truck tire **sewn** into a large loop, drives another wide wooden pulley turning on a second iron pipe axle anchored to two posts on opposite sides of the stream. This second axle is carefully positioned **parallel** to the first one so that the drive belt is taut and does not creep to the side and jump off the pulley. This is the most **crucial** adjustment in this simple system.

The secondary drive wheel is made from a 40 cm bicycle rim with welded concrete-reinforcement bar spokes, welded onto the iron pipe **axle** driven by the primary drive belt. The

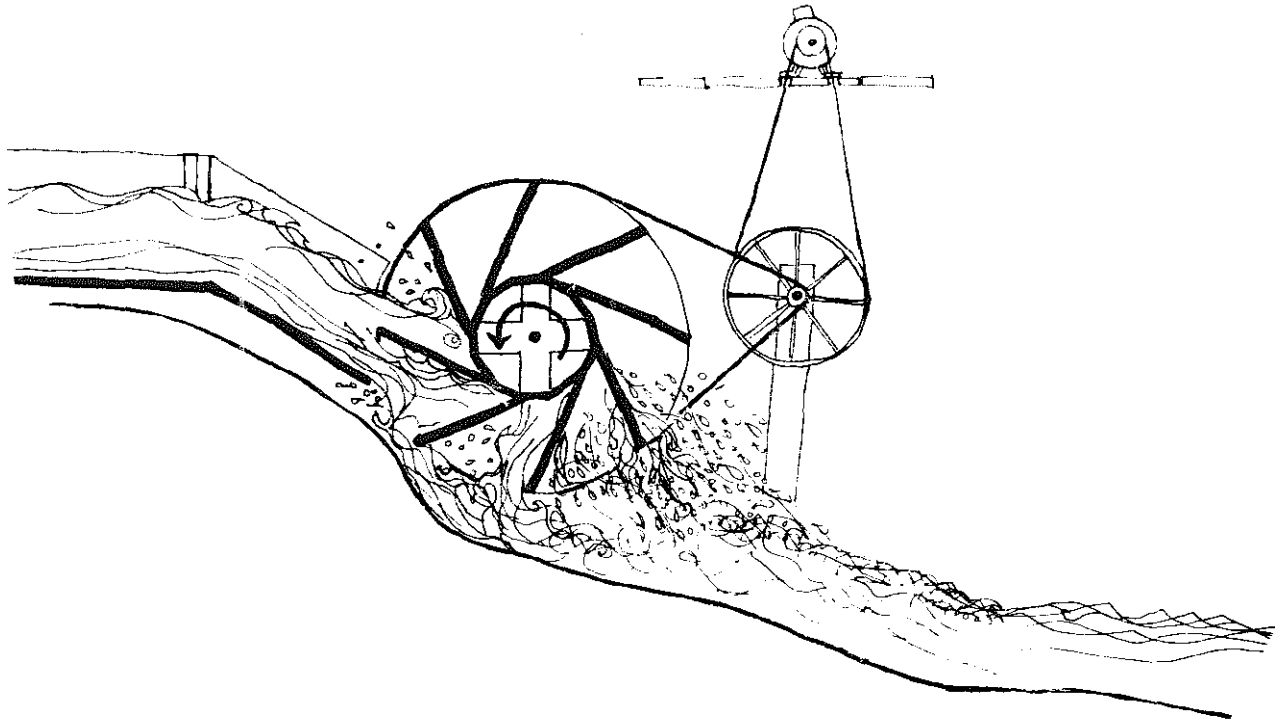

secondary drive belt, made from a much narrower strip of tire rubber, runs through two holes in the floor of the *Stroom Accu* shack to loop around the alternator's pulley. The original pulley is still on the ahemator.

The pulleys' final drive ratio is almost 1:100, meaning that the alternator should be spinning at almost 5000 rpm. However, belt slippage reduces the actual speed to less than half of that. This is still enough to keep the needle of the automobile ammeter installed above the alternator pointing at 30 amps, plenty of power for this one farmer's lights and *Stroom Accu* business.

Decorative Windmills/Kitiran

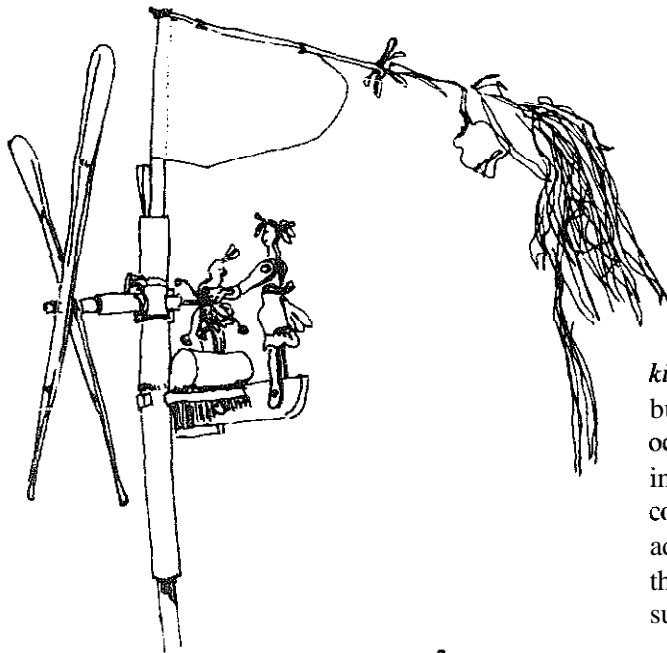

Small wooden or bamboo windmills called *kitiran* are common in many parts of Indonesia, but they are used only for decorations, or occasionally for scaring birds away from ripening rice fields. It is surprising that a nation colonized by the Dutch for 350 years did not adopt the technology always associated with the Netherlands for more practical purposes such as lifting water or grinding grain.

Kitiran have two or four wooden or bamboo blades, cut and fastened so that they present slanted surfaces to the wind. Many *kitiran* have long tails and are set on swiveling bamboo bases so that they can turn to always face into the wind.

On some *kitiran*, the propellers are connected to a shaft, the opposite end of which is a crank which moves a wooden doll, usually a shadow puppet character, a bicyclist, or a horse. On others the shaft turns one or two *clackers* which strike against cans or short sections of bamboo, causing a clacking noise which startles birds.

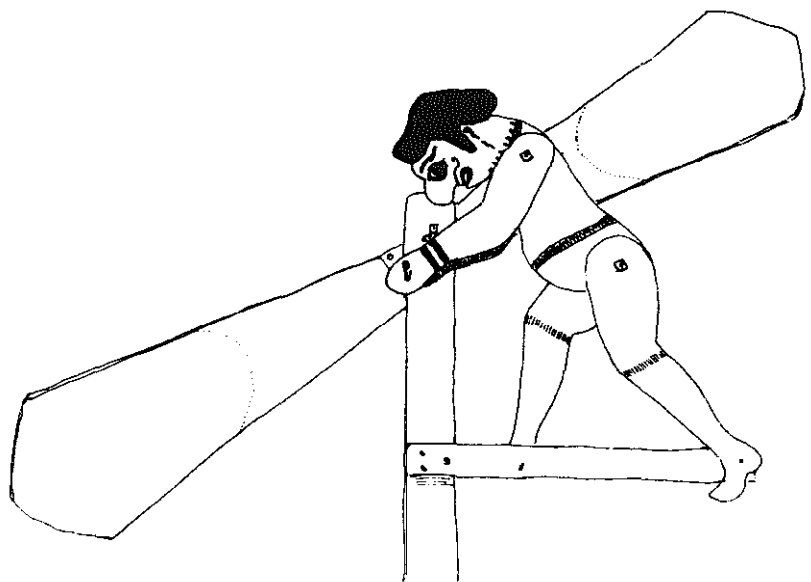
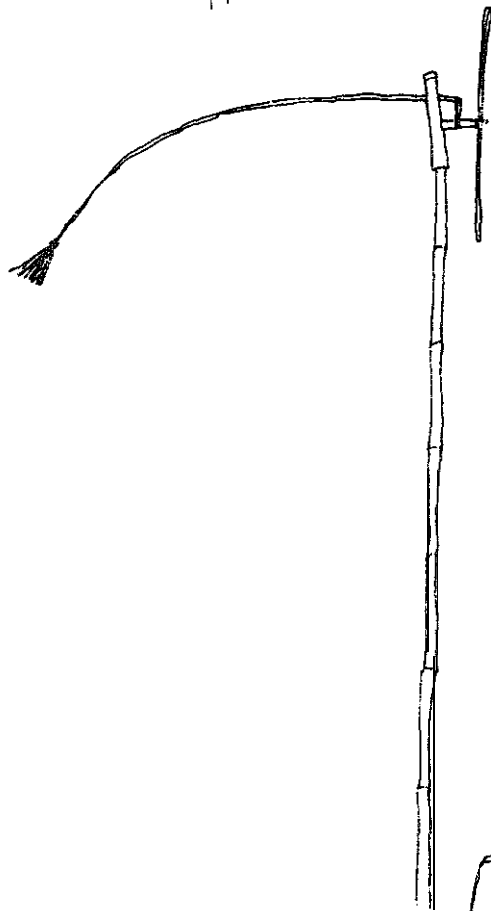

Drawing Table/Meja Gambar

Most of the drawings in this book were made from slides taken of the various tools and activities. The slides were projected onto the back of the drawing paper and traced, using a small slide projector and a glass-topped adjustable drafting table.

The table was purchased from a carpenter near **Institut Teknologi Bandung**. He sells cheap wooden furniture such as cabinets, bed frames and tables. A large number of technical and **architecture** students need inexpensive drafting tables; the imported models are prohibitively expensive. The simple design of this table allows it to be produced quickly from inexpensive wood and sold at a low price. Notches in the table support arms and in the front legs allow adjustment of both the height and angle of the drawing board.

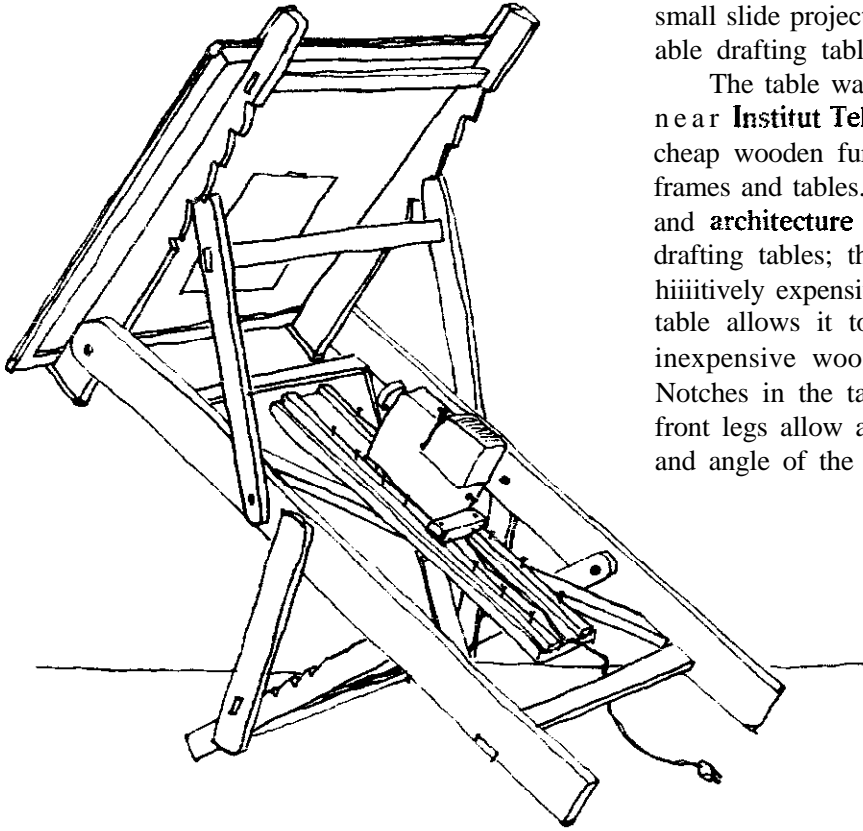

My own modifications to the table include a 70 by 90 cm sheet of 5 mm thick glass with a wooden frame for the drawing board, and a platform for the slide projector. The size of the picture can be adjusted by sliding the projector forward and backward. A short piece of wood with two holes in it fits over nails set in the two rails on the platform to hold the projector in the desired position.

At the outset of this project, we agreed that drawings can convey messages more clearly than photographs; with drawings, certain features can be emphasized and distractions eliminated. Drawings are also more easily reproduced by tracing or photocopying than are photographs. Without this glass drafting table, this book would have been a much more difficult and time consuming venture.